



ZROADZ

DYNAMIC LED MOUNTING SOLUTIONS



PROFESSIONAL INSTALL RECOMMENDED

2018 JEEP WRANGLER JL

PART#: Z374831 / Z374831-KIT2 / Z374831-KIT4
Z374831-KIT / Z374831-BK2 / Z374831-BK4

FRONT ROOF / A-PILLAR LED LIGHT MOUNTS

PARTS INCLUDED

- (1) Driver Side Mounting Bracket
- (1) Passenger Side. Mounting Bracket

LED LIGHTS INCLUDED

Z374831 - No LED Lights Included

374831-KIT - (1) 50" LED Light Bar

Z374831-KIT2 - (1) 50" LED Light Bar & (2) 3" Pods

Z374831-KIT4 - (1) 50" LED Light Bar & (4) 3" Pods

HARDWARE INCLUDED

- (1) - DriverSide Gasket Base Support
- (1) - Passanger Side Gasket Base Support
- (8) - Gasket Strips
- (4) - ZROADZ Logo Backing Plate
- (4) - 3/4" x 1/4" Aluminum Spacers
- (4) - 3/8" x .810 Aluminum Spacers
- (4) - 3/4" x 13/32" Aluminum Spacers
- (4) - M6 x 1mm x 50mm Round Head Black Screws
- (4) - M8 x 1.25mm x 30mm Button Head Black Screws
- (8) - 10-32 x 1/2" Button Head Screws
- (8) - #10-32 Flange Nuts
- (2) - Torx Screws
- (2) - 5/16" Black Flat Washers
- (1) - 1" Long Torx T-40 Bit
- (1) - Power Cable Wiring Harness

TOOLS REQUIRED

- Air Hose & Nozzle
- Alcohol Cleaning Solution
- Cleaning Rag
- Socket Set & Ratchet Tool
- Ratchet Extensions
- Various Wrenches
- Dikes or Snips
- Torq Bit Set
- Heat Gun

INSTALLATION GUIDE

START HERE

PLEASE READ AND UNDERSTAND ALL INSTRUCTIONS BEFORE INSTALLATION. Auto makers offer varied models to each vehicle and occasionally manufacture more than one body style of the same model.

* APPLICATION MODELS VARY. WE RECOMMEND TO VERIFY FITMENT BEFORE BEGINNING INSTALLATION PROCESS.
* IMAGES FEATURED IN THE INSTRUCTION DOCUMENTS MAY NOT ALWAYS EXACTLY MATCH YOUR MODEL OR PART.

BEFORE YOU BEGIN

START HERE: Turn off engine, chalk tires with stop block, open the hood and disconnect the battery.

LED LIGHT BRACKET INSTALLATION



STEP 1

1) Layout and organize all the provided parts.

PRO TIP:

APPLY A PROTECTIVE LAYER OF 3M MASKING TAPE AROUND THE APPLICATION AREA.

STEP 2

SEE FIGURE 2

2) Match up the gaskets to the appropriate mounting bracket.

Peel off the gasket protective tape.



FIG 2



LED LIGHT BRACKET INSTALLATION - CONTINUED

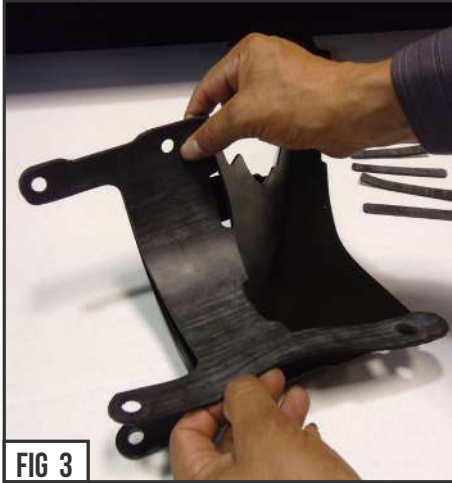

STEPS 3 & 4

SEE FIGURE 3 & 4

Identify which Gasket goes on Driver Side and which Gasket goes on Passenger side. Each has a pattern that matches the Mounting Brackets.

3) Carefully put gasket into position sticky side down facing Mounting Brackets.

4) Take the Gasket strips and put them into place along the A-Pillar section as seen in Figure #4.

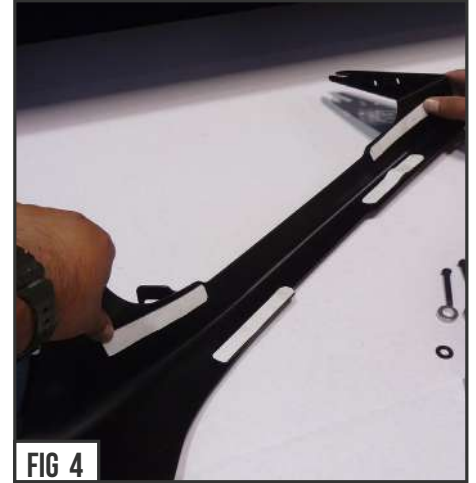

STEP 5

SEE FIGURES 5 & 6

5) Remove JEEP A-Pillar Screws from vehicle. There are (2) on top near Hood Hinge and (2) on side near door hinge as seen in Figures #5 & #6.



STEP 6 INSTALLERS NOTE: Mock Up LED Lights and plumb wires.

SEE FIGURES 7 - 9

6) With the Screws removed, you should now be able to remove the Vehicle's A-Pillar / Fender panel. Plumb any and all LED Lights power harness through and behind fender / hood. It is recommended and designed to hide the roof level LED Light Bar Power Wire behind the ZROADZ Mounting Brackets. Now is the time to carefully set LED Light Bar up on roof area and mock up the power wire along Vehicle's A-Pillar exterior.

LED LIGHT BRACKET INSTALLATION - CONTINUED



LED LIGHT BRACKET INSTALLATION - CONTINUED

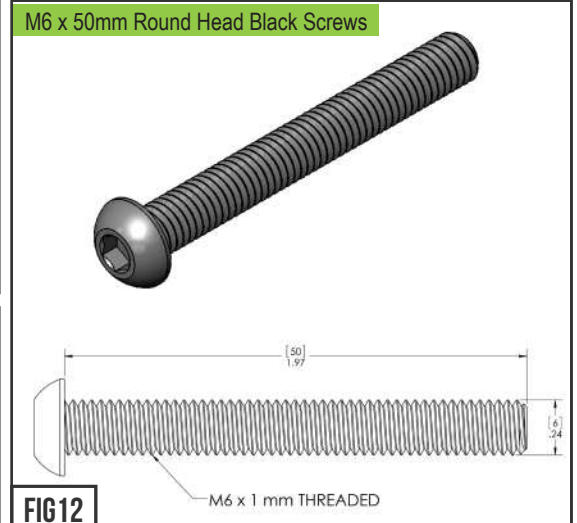
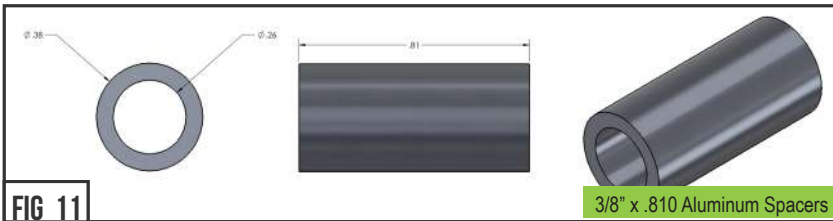
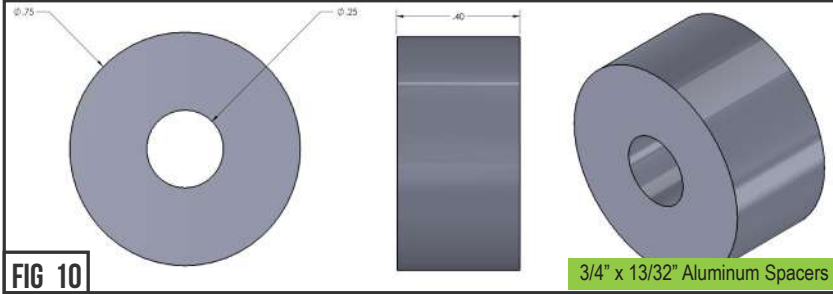

STEP 7 INSTALLERS NOTE: Put into place ZROADZ Mounting Brackets.

SEE FIGURES 10 - 12

7) Put back into place and install Vehicle's Fender Panel with new supplied hardware as follows:
Assemble the provided Aluminum Spacers (3/4" x 13/32" - Figure #10) & (3/8" x .810" - Figure #11) as seen & configured in Figure #15 and put them into the Vehicle's TOP mounting locations. The Aluminum Spacers will be stacked on top of each other with the long one going in first.

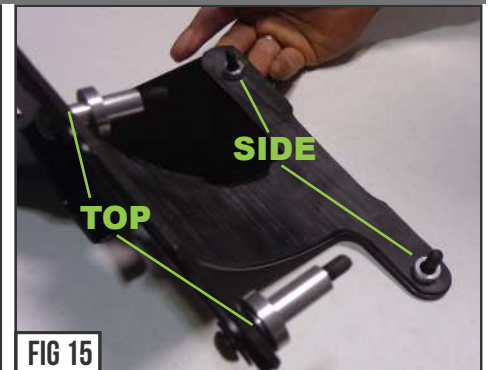

STEP 8

SEE FIGURE 16

8) Take the other provided Aluminum Spacers (3/4" x 1/4" Aluminum Spacers) and insert them into the Vehicle's SIDE mounting locations.



STEP 9

SEE FIGURE 17

9) Carefully put into place the ZROADZ Mounting Brackets to Jeep JL A-Pillar. Check for clearances and proper placement of gaskets for coverage and protection of vehicle finish. Route & hide the Roof Level LED Light Bar Power Harness down the Vehicle's A-Pillar behind ZROADZ Mounting Bracket. Use the provided M6 x 50mm Round Head Black Screws to secure mounts to Jeep.

LED LIGHT BRACKET INSTALLATION - CONTINUED



LED LIGHT BRACKET INSTALLATION - CONTINUED

INSTALLERS NOTE: STEP #10 DOES NOT APPLY TO PARTS: Z374831 / Z374831-KIT

STEP 10

SEE FIGURES 18 & 19

10) Install any ZROADZ LED Light Pods to the pre-determined A-Pillar Tabs using the provided LED Light Pod Hardware.

M8 x 20mm Bolts
M8 Lock Washers
M8 Hex Nuts

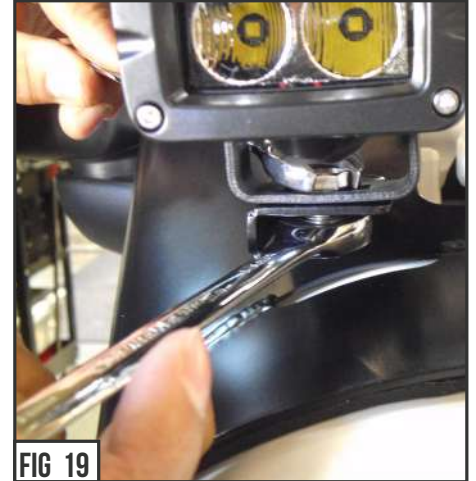

ROOF LEVEL LED LIGHT BAR INSTALL

STEP 11

SEE FIGURES 20 - 22

11) Put into place the LED Light Bar and position it at Vehicle's Roof Level in between the ZROADZ Mounting Brackets.

Secure LED Light Bar using the provided T-40 Torx Anti-Theft Screws and the 5/16" Flat Washers



STEP 12

12) Go over and tighten all hardware. Secure all LED Light Power Wires and connect harness.

STEP 13

13) ZROADZ recommends LED Lights be wired with ZROADZ harness kit (part# Z390020S-A) or by utilizing a compatible custom wiring harness. Wiring must be installed by competent & knowledgeable automotive electrician.



STEP 14

ADJUSTMENT TIPS

14) To adjust the angle of your Light Bar, rotate the LED(s) to adjust the angles till your desired light pattern is reached. There will be minimal adjustment due to curved light bar orientation. You may then tighten the hardware and secure everything into place. Be careful not to over tighten the mounting hardware.

It is best to adjust the angle with the vehicle on level ground with lights facing a wall, garage door or other solid barrier. We recommend checking from a distance of 25'. Your installation is now completed.



LED LIGHT BRACKET INSTALLATION - PROCESS COMPLETE



ZROADZ

DYNAMIC LED MOUNTING SOLUTIONS

PRODUCT CARE INFORMATION

PRODUCT CARE INFORMATION

Wash regularly as you would when caring for your vehicles. Never use dish soap. Never leave wet water spots as that may leave a blemish.

MATTE BLACK FINISH

Paint warranty applies to defects in material and / or workmanship, it does not cover the matte finish surface appearance.

To enjoy the matte appearance for many years to come, please follow these owner care and maintenance tips.

Get a no-shine matte car wash soap that uses no fillers, no silicone, and won't strip your matte paint of its layer of protection.

Do not use wax, detail spray, armorall®, or any products made for normal paint. Use only products specifically developed for matte finish paint. Do not use products that are even mildly abrasive, such as polishes, glazes, or rubbing compounds. Do not use mechanical cleaners or polishers. Do not use terrycloth, cloth, or paper towels. Do not rub the finish vigorously, this will burnish the paint finish, causing a permanent shiny spot. Shiny spots cannot be removed.

Do not use commercial car wash facilities or their shine enhancement products. Most car wash brushes, large mechanized "towels," and shine enhancement products can damage matte paint.

Remove foreign substances such as insect remains, tar, and road debris using a soft applicator and a mild solvent; saturate and soak area before cleaning—rub lightly.

Hand-wash with a soft wash mitt and mild cleaning product safe for matte paint. Use microfiber cleaning cloths with alcohol-based window cleaner for basic surface clean-up.

GLOSS BLACK FINISH

ZROADZ with Gloss Black Powder Coated Finish may be washed regularly as you would when caring for your vehicles finish using soap and water. ZROADZ should be waxed at the same time that you wax the vehicle. As a general rule, anything you use to clean your vehicles painted surfaces can be used to clean and maintain your ZROADZ grille. A Gloss powder Coated Finish can be cared for in the same fashion that you would care for your vehicles factory paint job. Never leave wet water spots as that may leave a blemish.