



#J9200, J9300 Installation Instructions Jeep Wrangler TJ 2" & 3" Body Lift Kits

Read and understand all instructions and warnings prior to installation of product and operation of vehicle.

Zone Offroad Products recommends this system be installed by a professional technician. In addition to these instructions, professional knowledge of disassembly/ reassembly procedures and post installation checks must be known. Minimum tool requirements include the following: Assorted metric and standard wrenches, hammer, hydraulic floor jack and a set of jack stands. See the "Special Tools Required" section for additional tools needed to complete this installation properly and safely.

» PRODUCT SAFETY WARNING

Certain Zone Offroad Products are intended to improve off-road performance. Modifying your vehicle for off-road use may result in the vehicle handling differently than a factory equipped vehicle. Extreme care must be used to prevent loss of control or vehicle roll-over. Failure to drive your modified vehicle safely may result in serious injury or death. Zone Offroad Products does not recommend the combined use of suspension lifts, body lifts, or other lifting devices.

You should never operate your modified vehicle under the influence of alcohol or drugs. Always drive your modified vehicle at reduced speeds to ensure your ability to control your vehicle under all driving conditions. Always wear your seat belt.

Difficulty Level

easy 1 (2) 3 4 5 difficult

Estimated installation: 6 hours

Special Tools Required

None

Tire/Wheel Fitment

2" Lift: 32x10.50 Tire/15x8, 3.5" BS Wheel

3" Lift: 33x12.50 Tire/15x8, 3.5" BS Wheel

» PRE-INSTALLATION NOTES

1. Special literature required: OE Service Manual for model/year of vehicle. Refer to manual for proper disassembly/reassembly procedures of OE and related components.
2. Adhere to recommendations when replacement fasteners, retainers and keepers are called out in the OE manual.
3. Larger rim and tire combinations may increase leverage on suspension, steering, and related components. When selecting combinations larger than OE, consider the additional stress you could be inducing on the OE and related components.
4. Secure and properly block vehicle prior to installation of Zone Offroad Products. Always wear safety glasses when using power tools.
5. Zone Offroad Products body lifts are designed to be used on vehicles in good operating condition. It is not recommended that body lifts be used on vehicles in poor physical shape. This includes rusted body mounts, damaged or worn frame-to-body mounting brackets, and poor mechanical condition. Perform a visual inspection of the vehicle before beginning installation.

Kit Contents

» #J9200

Qty	Description
2	3"x2" Body Lift Block
9	2"x2" Body Lift Block
1	Bolt Pack - #203
1	Bolt Pack - #220
2	2"x3" Body Lift Block
2	Bump Stop
2	Threaded Sleeve
1	T-Case Linkage Bracket
1	Steering Support
1	Steering Carrier Bearing Support
1	Fuel Fill Extension (1.50" O.D.)
6	Radiator Relocation Bracket
1	Manual Shift Extension
1	5/8"x18" Fuel Vent Hose
2	#28 Hose Clamp
2	#10 Hose Clamp
2	Cable tie
3	Cable tie
1	Loctite
1	Manual Shift Extension
1	5/16" x 10" Fuel Vent Hose
1	Fuel Filler Extension (1" O.D.)
2	#20 Hose Clamp
Bolt Pack 203	
Qty	Description
6	7/16" USS flat washer clear zin
7	3/8" USS flat washer clear zin
2	3/8"-16 x 1-1/4" bolt grade 5 clear zinc
2	3/8"-16 x 2" bolt grade 5 clear zinc
2	1/4"-20 x 1" bolt grade 5 clear zinc
10	1/4" SAE flat washer clear zin
8	1/4"-20 prevailing torque nut clear zinc
2	5/16"-18 x 1-3/4" bolt grade 5 clear zinc
2	5/16" USS flat washer clear zin
2	7/16" SAE flat washer clear zin
1	7/16"-14 prevailing torque nut clear zinc
1	7/16"-14 x 1" bolt grade 5 clear zinc
1	10mm-1.50 x 60mm bolt grade 8.8 clear zinc
1	10mm flat washer clear zin

» #J9300

Qty	Description
2	3"x3" Body Lift Block
9	2"x3" Body Lift Block
1	Bolt Pack - #203
1	Bolt Pack - #221
4	2"x2" Body Lift Block
2	Bump Stop
2	Threaded Sleeve
1	T-Case Linkage Bracket
1	Steering Support
1	Steering Carrier Bearing Support
1	Fuel Fill Extension (1.50" O.D.)
6	Radiator Relocation Bracket
1	5/8"x18" Fuel Vent Hose
2	#28 Hose Clamp
2	#10 Hose Clamp
3	Cable tie
1	Loctite
1	Manual Shift Extension
1	5/16" x 10" Fuel Vent Hose
1	Fuel Filler Extension (1" O.D.)
2	#20 Hose Clamp
Bolt Pack 220 (#J9200)	
Qty	Description
6	1/2"-13 x 5-1/2" bolt
5	7/16"-14 x 4-1/2" bolt
Bolt Pack 221 (#J9300)	
Qty	Description
6	1/2"-13 x 6-1/2" bolt grade 5 clear zinc
5	7/16"-14 x 5-1/2" bolt grade 5 clear zinc

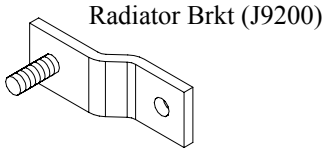

Radiator Brkt (J9200)

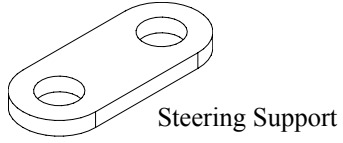

Steering Support

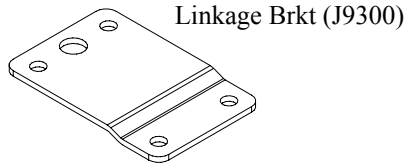

Linkage Brkt (J9300)

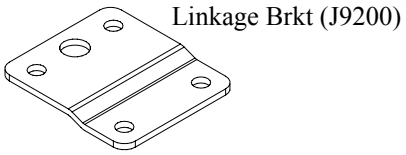

Linkage Brkt (J9200)

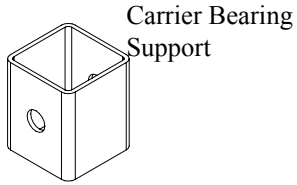

Carrier Bearing Support

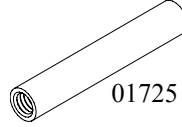

01725

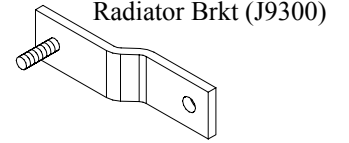

Radiator Brkt (J9300)

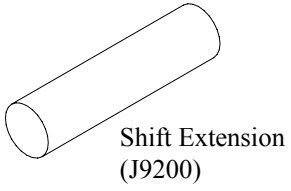

Shift Extension (J9200)

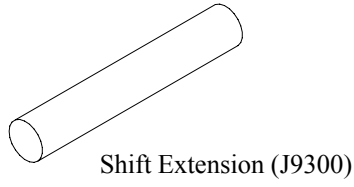

Shift Extension (J9300)

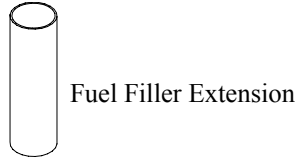

Fuel Filler Extension

INSTALLATION INSTRUCTIONS

1. Park the vehicle on a clean flat surface and block the wheels for safety. Place automatic transmissions in park and manual transmissions in neutral.
2. Remove the negative battery cable first, then the positive battery cable. If equipped, the Supplemental Restraint System will be deactivated when the battery is disconnected.

» FRONT/UNDER HOOD

3. Remove the four bolts attaching the front plastic cover to the frame and remove the cover from the frame (Figure 1). Save cover and hardware.



Figure 1

4. If equipped with factory auxiliary headlights on the front bumper, remove the two clips and wiring harness from the fenders.
5. Remove the three screws holding the headlight bezels to the core support and remove the bezels from the vehicle (Figure 2). Save bezel and hardware.

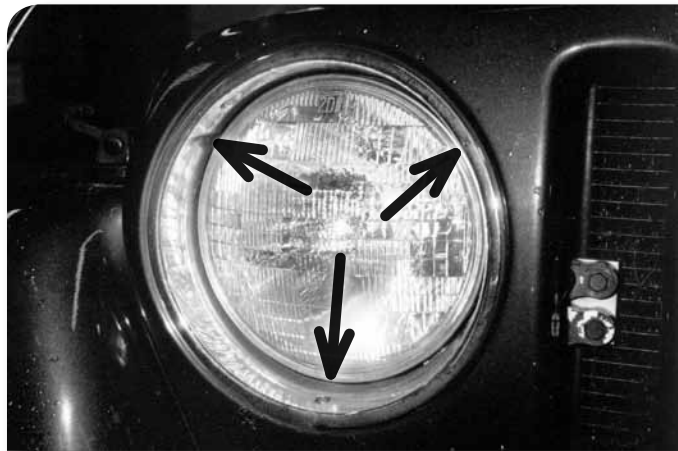

Figure 2

6. Remove the radiator overflow hose and overflow bottle from the fan shroud and remove them from the vehicle. (Figure 3).

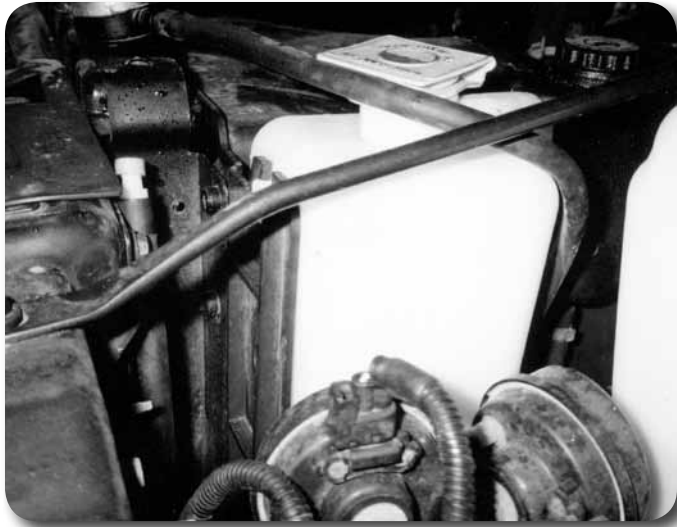

Figure 3

7. Remove the four bolts mounting the fan shroud to the radiator and move the shroud back toward the engine, off of the radiator (Figure 3). Save hardware.



Figure 4

8. Remove the six bolts mounting the radiator to the core support (Figure 4). Carefully rest the radiator against the fan. It will be relocated after the lift is installed. Save hardware.
9. Remove the air intake hose from the engine compartment by removing the vacuum line and loosening the hose clamp at the air box and at the throttle body.
10. Remove the two bolts mounting the steering shaft carrier bearing to the driver's side frame rail (Figure 5).

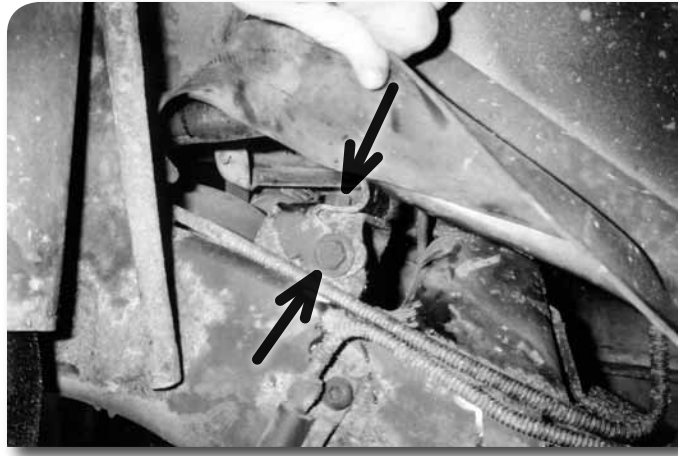

Figure 5

11. Pull back the carpet on the driver's side near the center console. Remove the four bolts with captive washers (Figure 6). This will free the transfer case linkage bracket from the underside of the body. Save hardware.

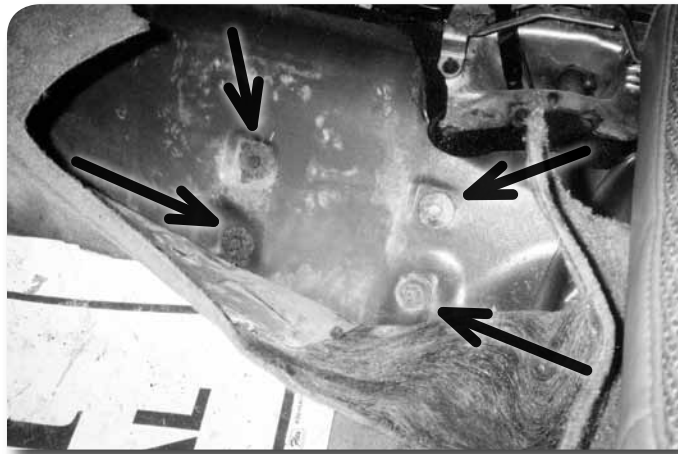

Figure 6

12. From underneath, remove the two bolts from the transfer case shift linkage pivot bushing plate. Remove the pivot plate and bracket from the vehicle. Save all components.

»» **MANUAL TRANSMISSION VEHICLES**

The following steps are required for the 3" (J9300) body lift. The shift lever may not need to be extended with 2" (J9200) body lifts to operate properly. These steps can be delayed until the end of the installation (2" only) so the shift lever operation can be checked. If all gears can be fully engaged then the extension is not necessary. The lever can also be heated and bent if minor interference is detected.

»» **1997-2002 MODELS**

13. Ensure that the transmission is in neutral.
14. Remove the manual shift lever knob and pull the shift boot free from the console and up off of the lever.
15. Remove the screws holding the console to the floorboard and remove the console from the vehicle.

16. Remove the screws mounting the rubber shift boot to the floorboard and pull the boot up and off of the lever.
17. Pull the small shift lever dust boot free at the top of the transmission to expose the shift lever retaining collar.
18. Push down on the shift lever retaining collar and rotate it counter-clockwise. Pull the lever up free from the transmission (Figure 7A). Cover the hole in the top of the transmission with a clean rag.

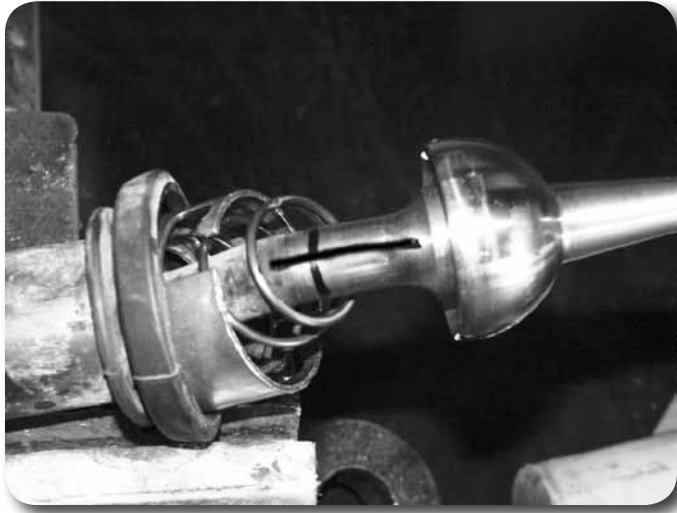

Figure 7A

19. Pull the dust boot, retaining collar and spring up on the shift lever as far as possible.
20. Make an alignment mark along the shift lever just below the first bend. Make a second “cut” mark perpendicular to the first mark just below the bend (Figure 7B). Note: Make sure the alignment mark is visible on both sides of the cut.



Figure 7B

21. Cut the lever in two at the cut mark.
22. Make an alignment mark along the length of the provided manual shift lever extension. Align the marks on each section of the shift lever with the mark on the extension and weld the three pieces together. Note: All welding should be performed by a certified welder.

23. Install the modified shift lever in the transmission by pushing down on the retaining collar and turning it clockwise until it locks. Install the shift lever dust boot on the transmission. The console will be installed later.

»» **2003-2006 MODELS**

24. Ensure that the transmission is in neutral.
25. Pull the shift lever cover free from the center console and up the lever.
26. Remove the shift lever mounting bolt and remove the lever from the vehicle.
27. Make an alignment mark and cut line approximately 1" above the coupler end of the shift lever (Figure 8)

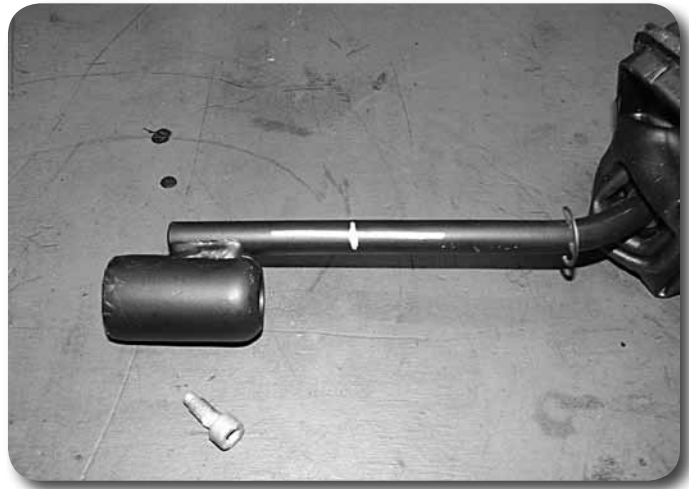

Figure 8

28. Cut the shift lever on the cut line. Position the provided weld-in extension between the two shift lever halves. Align the marks on the two halves and weld the extension in place.
29. Paint all exposed metal to prevent corrosion.
30. Reinstall the modified shift lever in the vehicle with the OE bolt. Tighten bolt to 25 ft.lbs.
31. Reinstall the shift lever cover to the console.

»» **REAR**

32. Remove the fuel filler cap and remove the four screws mounting the fuel shroud to the body. Remove the four screws mounting the filler neck to the shroud. Remove the shroud from the vehicle.

»» **BODY LIFT**

33. Loosen all body mounting bolts (11 in all) but do not remove.
34. Remove the body mounting bolts on the passenger's side of the vehicle and the front center bolt. Using a hydraulic jack and a wooden block, lift passenger's side of the vehicle up just high enough for the body spacers to be placed. The two 3" diameter spacers go on the mounts located directly behind the front axle on either side on the vehicle. It will not be possible to install the front center spacer until the entire vehicle has been lifted. Watch for hoses or wires that may be binding or stretching while lifting.
35. Start but do not tighten the new mounting bolts. They are installed in the following locations with the OE bushings;

7/16"-14 x 4-1/2" (7/16" x 5-1/2" for 3" kit) with 3/8" USS washers in the front-center and two rear mounts, and 1/2"-13 x 5-1/2" (1/2" x 6-1/2" for 3" kit) with 7/16" USS washers in the three mounts along the frame under the doors.

36. Repeat installation procedure for the driver's side of the vehicle and install the front center mount.
37. Check body for correct alignment on the frame. Torque 1/2" hardware to 60 ft-lbs and 7/16" hardware to 40 ft-lbs. Use Loctite on all body mounting hardware.

Step 35 Note

Body mount hardware is located in hardware pack #220 for a 2" lift and hardware pack #221 for a 3" lift.

Installation Note

All hardware needed for the installation of the remaining components is located in hardware pack #203.

» FRONT

38. Remove the urethane body support bumpers from the core support. (Fig. 1)
39. Coat the threads of the provided hexagon bump stops with loctite and thread them into the provided tapped sleeves.
40. Install the bump stop/sleeve assembly in the body blocks provided. For 2" kits, use a 3" tall x 2" wide block. For 3" kits, use 2-2"x2" blocks. (Fig 9A, 9B)



Figure 9a



Figure 9B

41. Mount the support bumper assembly to the original location on the core support with 3/8" x 1-1/4" bolts for 2" kits or 3/8" x 2" bolts for 3" kits and 3/8" USS washers. Access the hole in the core support through the headlight hole in the grill. Use Loctite on the 3/8" mount bolts and torque to 20 ft/lbs.
42. Install the headlight bezels with the OE hardware.
43. Install the air intake tube on the throttle body and air box with the OE clamps. Attach the vacuum hose to the tube.
44. Install the six radiator drop brackets to the core support using the OE radiator mounting hardware.
45. Mount the radiator on the relocation brackets. If equipped with A/C, mark the passenger's side radiator bracket where there is interference with the A/C line.

46. If equipped with A/C, remove the passenger's side radiator bracket and trim where marked. Reinstall the bracket on the radiator with OE hardware and check for proper A/C line clearance.
47. Fasten the radiator to the relocation brackets with 1/4" lock nuts and washers. Torque all radiator mounting hardware to 10 ft-lbs.
48. Install radiator fan shroud to the radiator with the four OE bolts. Tighten securely.
49. Install the overflow bottle and overflow hose to the radiator and fan shroud.
50. Mount the provided steering carrier bearing spacer tube between the steering carrier bearing and the frame. Attach with the 10mm x 60mm bolt through the original mounting hole in the carrier bearing, through the tube, and into the threaded hole in the frame bracket. (Fig. 10) Do not tighten. Use Loctite on mounting bolts.



Figure 10

51. Install the side strap on the frame with the OE bolt. Do not tighten.
52. Mount the side strap to the carrier bearing using a 7/16" x 1" bolt, nut and SAE washers. (Fig. 11)



Figure 11

53. Tighten 10mm and 7/16" bolts to 30 ft-lbs.
54. If equipped with factory auxiliary headlights, reconnect and secure the wiring harnesses to the fenders with two zip ties.
55. Install the Jeep front cover with the four OE bolts. Tighten securely.

» REAR

56. Mount the pivot bushing to the relocation bracket (Fig. 12).

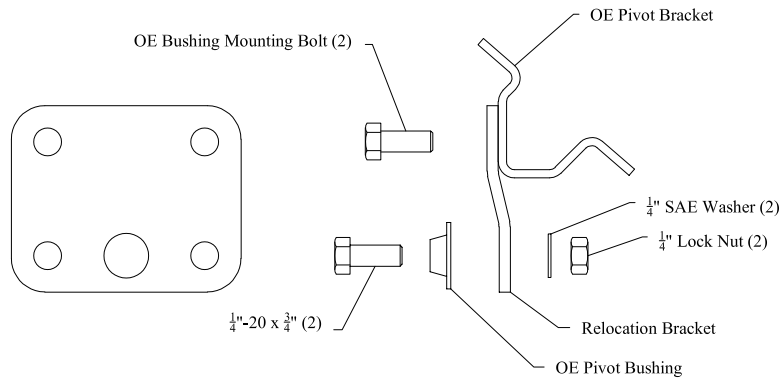

Figure 12

57. Mount the pivot bushing relocation bracket to the OE bracket as shown in the figure 12. Torque all mounting hardware to proper specs.
58. Install the modified bracket assembly in the original location under the floorboard by sliding the linkage rod through the pivot bushing. Fasten the bracket to the floorboard using the OE hardware. Torque hardware to proper specs.
59. Check the 4wd lever operation to ensure that there is engagement in all ranges. Adjust the linkage as necessary.
60. Remove the rear vent line from the fuel filler assembly by removing the zip tie if equipped.
61. Remove the two clamps mounting the fuel filler and fuel vent to the fuel tank. Remove the filler assembly from the vehicle.
62. Cut the filler hose in half and install the extension and new clamps. Leave clamps loose for adjustment.
63. Remove the vent hose and replace with the extended hose and clamp provided. Note: 03-06 Models use the smaller 5/16 hose. No clamps are needed.
64. Install the fuel filler assembly on the fuel tank with the original clamps. Adjust the assembly to the correct position and tighten all hose clamps.
65. Zip tie the axle vent tube to the fuel vent tube.
66. Install the fuel filler shroud to the body with the four OE screws.
67. Install the fuel filler assembly to the shroud with the four OE screws and install the fuel cap.
68. Install the rubber shift boot to the floorboard using the stock mounting screws.
69. Install the console in the vehicle with the stock mounting screws.
70. Install the outer shift boot over the shift lever and snap it into place in the console.
71. Install the shift lever knob.

» POST-INSTALLATION

72. Check torque on all hardware.
73. Reconnect battery cables. Connect positive first, then negative.
74. Retorque hardware after 500 miles.

Post-Installation Warnings

1. Check all fasteners for proper torque. Check to ensure for adequate clearance between all rotating, mobile, fixed, and heated members. Verify clearance between exhaust and brake lines, fuel lines, fuel tank, floor board and wiring harness. Check steering gear for clearance. Test and inspect brake system.
2. Perform steering sweep to ensure front brake hoses have adequate slack and do not contact any rotating, mobile or heated members. Inspect rear brake hoses at full extension for adequate slack. Failure to perform hose check/replacement may result in component failure. Longer replacement hoses, if needed can be purchased from a local parts supplier.
3. Perform head light check and adjustment.
4. Re-torque all fasteners after 100 miles. Always inspect fasteners and components during routine servicing.