



## #F9285, F9385 Installation Instructions 1997-2003 Ford F-150, F-250 LD 2/4wd 2"/3" Body Lift Kits

### Read and understand all instructions and warnings prior to installation of product and operation of vehicle.

Zone Offroad Products recommends this system be installed by a professional technician. In addition to these instructions, professional knowledge of disassembly/ reassembly procedures and post installation checks must be known. Minimum tool requirements include the following: Assorted metric and standard wrenches, hammer, hydraulic floor jack and a set of jack stands. See the "Special Tools Required" section for additional tools needed to complete this installation properly and safely.

#### » PRODUCT SAFETY WARNING

Certain Zone Suspension Products are intended to improve off-road performance. Modifying your vehicle for off-road use may result in the vehicle handling differently than a factory equipped vehicle. Extreme care must be used to prevent loss of control or vehicle rollover. Failure to drive your modified vehicle safely may result in serious injury or death. Zone Offroad Products does not recommend the combined use of suspension lifts, body lifts, or other lifting devices.

You should never operate your modified vehicle under the influence of alcohol or drugs. Always drive your modified vehicle at reduced speeds to ensure your ability to control your vehicle under all driving conditions. Always wear your seat belt.

#### Difficulty Level

easy 1 2 **3** 4 5 difficult

Estimated installation: 4-6 hours

#### Special Tools Required

T50 and T55 Torx Bit

1/4" bit/drill

Air Chisel, Cut-off tool or equivalent for rear bumper bracket removal

#### » PRE-INSTALLATION NOTES

1. Special literature required: OE Service Manual for model/year of vehicle. Refer to manual for proper disassembly/reassembly procedures of OE and related components.
2. Adhere to recommendations when replacement fasteners, retainers and keepers are called out in the OE manual.
3. Larger rim and tire combinations may increase leverage on suspension, steering, and related components. When selecting combinations larger than OE, consider the additional stress you could be inducing on the OE and related components.
4. Secure and properly block vehicle prior to installation of Zone Offroad Products. Always wear safety glasses when using power tools.
5. Zone Offroad Products body lifts are designed to be used on vehicles in good operating condition. It is not recommended that body lifts be used on vehicles in poor physical shape. This includes rusted body mounts, damaged or worn frame-to-body mounting brackets, and poor mechanical condition. Perform a visual inspection of the vehicle before beginning installation.

## Kit Contents

Qty	Part
16	3" Body Blocks (3" Lift Only)
16	2" Body Blocks (2" Lift Only)
1	Bolt Pack-Body Bolts (#224 - 3" Lift Only)
1	Bolt Pack - Body Bolts (#227 - 2" Lift Only)
1	Bolt Pack - Rear Bumper (#229)
1	Bolt Pack - Front Bumper, Etc (#211)
2	Radiator Drop Bracket
4	Metal Bed Spacer
2	Front Bumper Bracket
1	Rear Bumper Bracket (drv)
1	Rear Bumper Bracket (pass)
1	Transmission Cable Bracket
1	Lower Fan Shroud Bracket
1	1-1/2" x 5" Filler Extension
2	5/8" O.D. 3/8" I.D. x 2 5/8" sleeve
1	Steering Extension
2	#28 Hose Clamp
2	#10 Hose Clamp
1	1/2" x 13" Fuel Vent Hose
2	Zip ties
1	Loctite



## INSTALLATION INSTRUCTIONS

1. Remove negative battery cable, then positive battery cable from the battery. If equipped, the Supplemental Restraint System will be deactivated when the battery is disconnected.

### » STEERING

2. Lock the steering wheel so it can not turn.
3. Located under the dash, remove the bolt that connects the steering shaft universal joint to the steering column and separate the steering shaft from the steering column. **Figure 1** Save bolt.

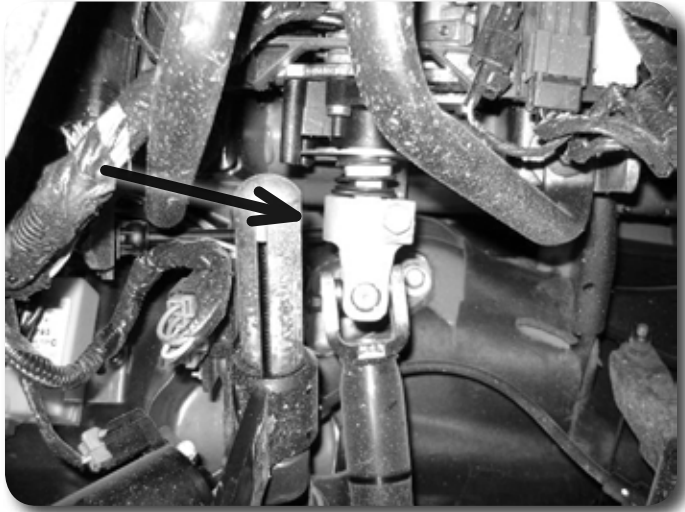

Figure 1

4. Locate the provided steering extension and install the provided 1/4" set screw. **Figure 2A** Only start the screw into the side of the extension. Install the steering extension on the steering column. **Figure 2B** Install the provided 3/8" Allen head bolt in the extension. Make sure the bolt goes through the retaining groove on the steering column. Tighten the Allen head bolt to 40 ft-lbs. The extension will be attached to the steering shaft after lifting operation is complete.

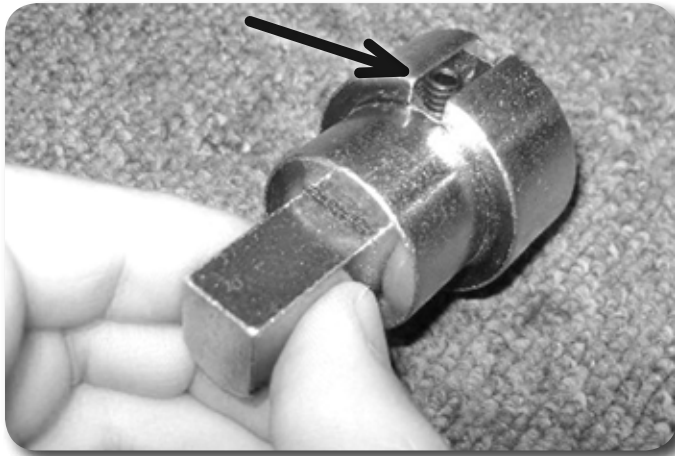

Figure 2A

#### Step 4 Note

Steering extension hardware is located in hardware pack #211.



Figure 2B

---

### » INTERIOR REMOVAL

5. Remove the doorjamb scuff plates by pulling up on them to release the retaining clips. Pull the kick panels back toward the door to release them from the retaining clips.
6. Pull the carpet back to gain access to the front cab mounting bolts **Figure. 3**. The bolt head is located under the rubber cap. Pull on the cap to remove. Save cap.

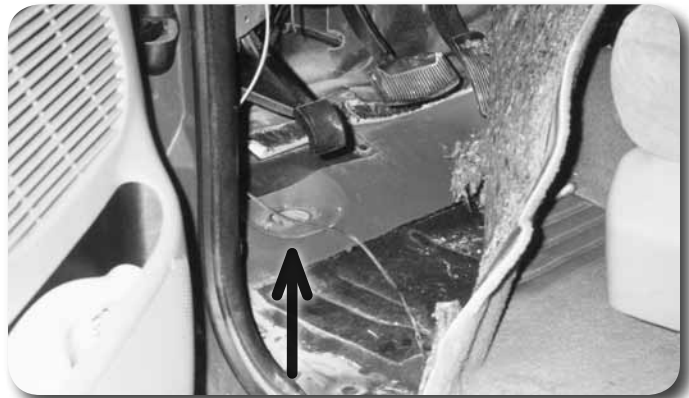

Figure 3

#### *Super Cab Models Only*

7. The rear seat must be removed to gain access to the four rear cab mounts. Fold the seat forward and remove the two bolts mounting the seat to the floorboard. Fold the seat back. Remove the three bolts and three nuts that hold the seat legs to the floorboard. Lift the seat off the studs and remove it from the vehicle. Save all hardware.
8. Pull the carpet back behind the front seat to expose the rear cab mounting bolts **Figure. 4**. There are four on super cabs and two on standard cabs.

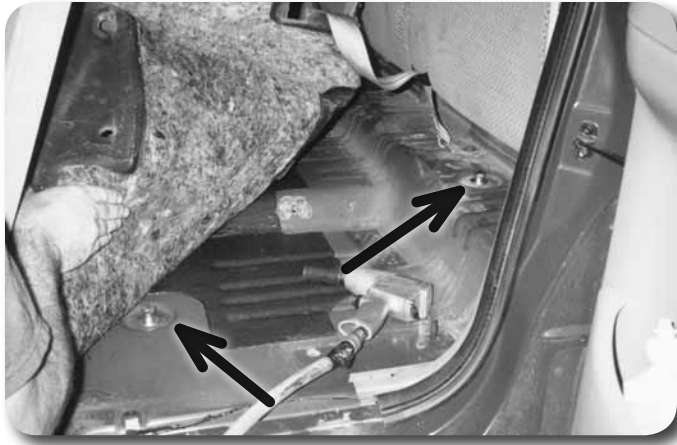

Figure 4

***Super Crew models only***

9. The rear seats must be removed to gain access to the four rear cab mounts. Remove the rear door scuff plates. Remove the covers from the feet of the seat legs to expose the seat mounting bolts. Remove the mounting bolts from the front legs. Save all hardware
10. Fold the seat back forward to expose the rear seat mounting bolts. Remove the bolts. Remove the bolt mounting the outer seat belts to the floorboard. Remove the rear seats from the vehicle. Save hardware.
11. Remove the nuts from the four studs holding the rear plastic cover to the floorboard. Save hardware.
12. Pull the carpet back to expose the mounting bolts behind the front seats.
13. Open the two storage doors in the rear panel to access the rear cab mounting bolts. The jack will have to be removed from the passenger's side of the storage area. The plastic panel can be pulled forward to aid in accessing the mounting bolts.

**» UNDER THE HOOD**

14. Relocate the ground strap (if equipped) that runs from the upper firewall to the passenger's side of the intake manifold. Remove the wire that is mounted on the intake manifold and relocated it to the rear fuel rail mount **Figure. 5 shows relocated position.**

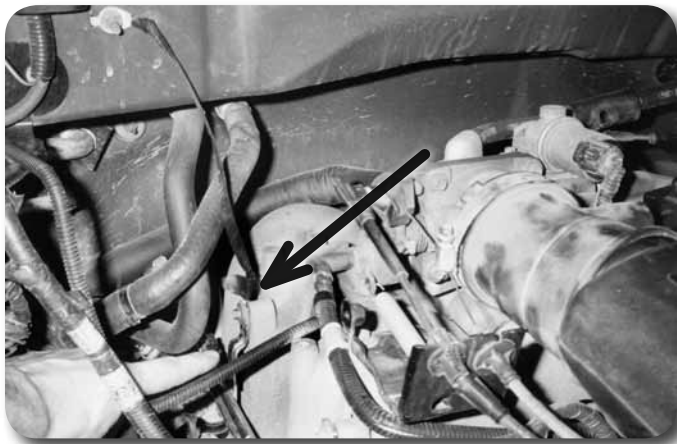

Figure 5

15. Remove the throttle body cover. Loosen and remove the air intake tube from the throttle body. **Figure 6A** Release the clamp holding the two halves of the air filter box together **Figure 6B** and move the air intake assembly back out of the way.



Figure 6A



Figure 6B

16. Remove the two plastic push-in fasteners holding the fan shroud to the upper shroud covering the area between the radiator and the grill. **Figure 7**

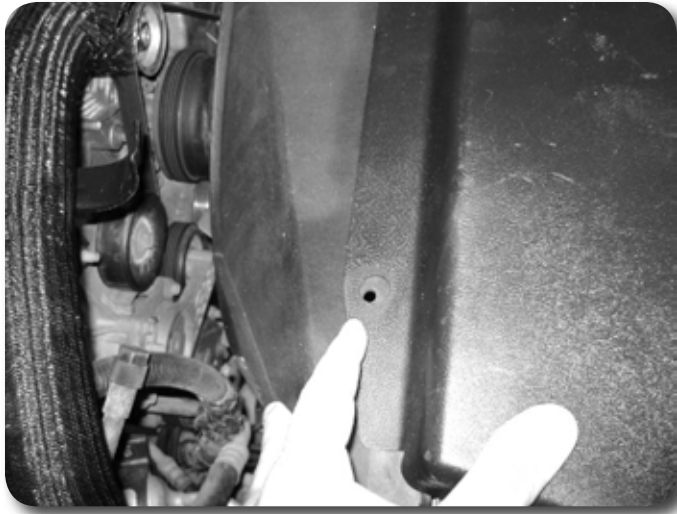

Figure 7

17. Remove the two bolts that mount the fan shroud to the radiator. **Figure 8** Pull up on the fan shroud to release it from the lower retaining clips. Set the shroud over the fan, away from the radiator. Save bolts.

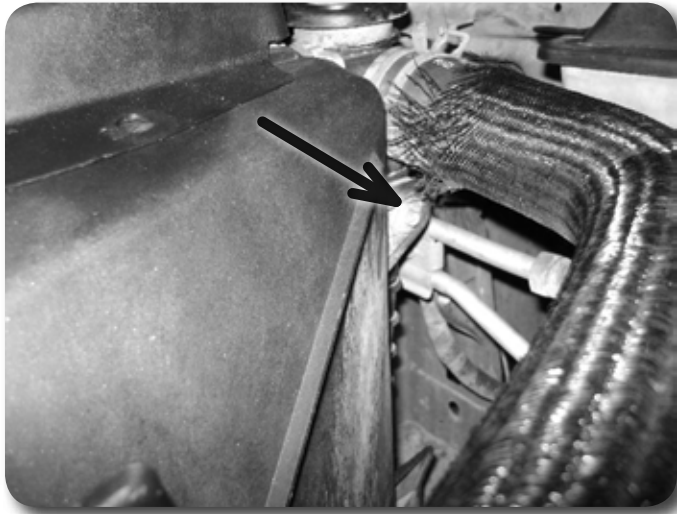

Figure 8

18. Remove the plastic push-in fastener that holds the battery cables to the bottom of the battery box. It may also be necessary to bend battery cable bracket on passenger side frame to gain adequate wire slack after lifting.

---

## » FRONT BUMPER REMOVAL

19. Carefully remove the plastic push-in fasteners that hold the air flap located between the bumper and the bottom of the core support from the core support only. **Figure 9** Allow the flap to swing down and hang from the bumper to gain access to the bumper mounting bolts. Save plastic fasteners.

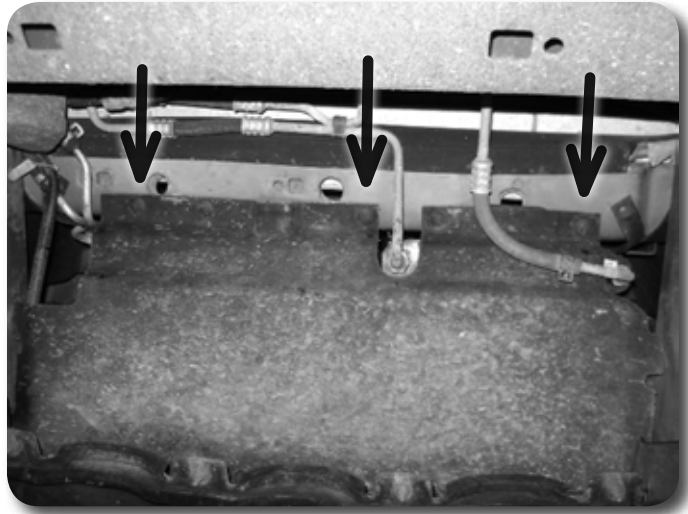

Figure 9

20. Disconnect driving light wires along with any other wires attached to the front bumper.
21. Remove the four nuts (two per side) mounting the bumper to the frame and remove the bumper from the vehicle. **Figure 10** Save hardware.

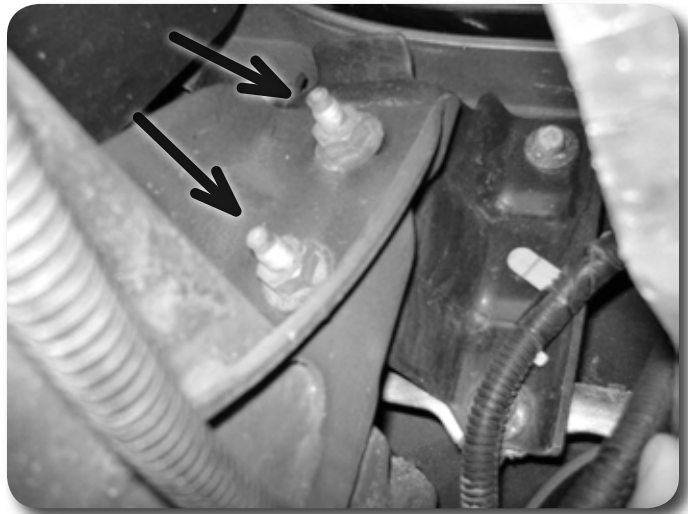

Figure 10

22. Remove the tow hooks from the vehicle. Remove the front mounting bolt and loosen but do not remove the rear bolt because it is in a slotted hole. **Figure 11** Slide the hook back and remove it from the rear bolt. Save hooks and hardware.





Figure 11

---

» **ON THE FRAME**

23. Remove the bolt that attaches the cab safety cables to the frame located under the driver's and passenger's doors. **Figure 12** They will be relocated after lifting. Save bolts.

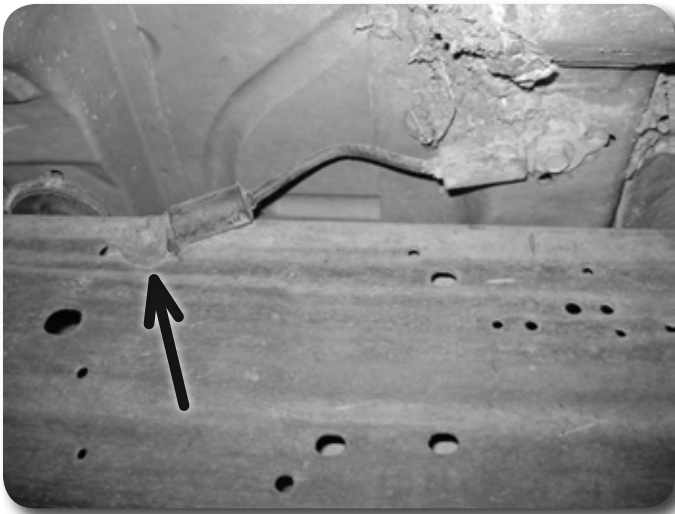

Figure 12

24. Disconnect the ground wire running from the body to the frame located under the passenger side door. **Figure 13** Disconnect the wire at the frame end. It will be relocated after lifting.



Figure 13

25. Remove the large steel line that runs on the outside of the driver's side frame rail from its front two retaining clamps. **Figure 14**
26. Check to see that the large wire loom on the driver's side frame rail has enough slack for three inches of lift. **Figure 14** Relocate as necessary.

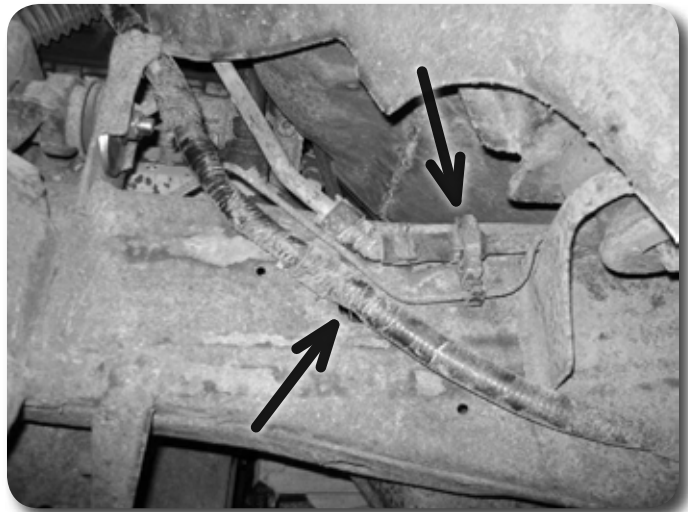

Figure 14

27. Remove the rubber rear axle breather tube from the bed cross member by pulling down on it, releasing the plastic fastener from the hole. The breather tube will be relocated after lifting.

---

## » OIL COOLERS

28. Remove the transmission and power steering oil coolers from the core support. **Figure 15** Allow them to hang out of the way so they are not damaged during lifting. Save hardware.

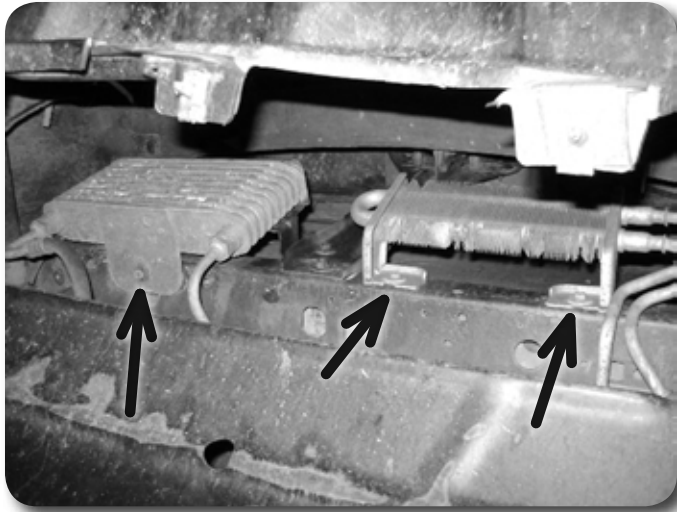

Figure 15

---

## » TRANSMISSIONS

29. **Automatic Transmissions:** Remove the two bolts that mount the shift cable to the driver's side of the transmission. Save bolts. **Figure 16A** A relocation bracket will be attached after lifting. The 5.4 liter engine is equipped with a different transmission that does not use the relocation bracket. The cable for this transmission must be removed from the stud located under the dash and then slid through the floor of the cab. **Figure 16B**

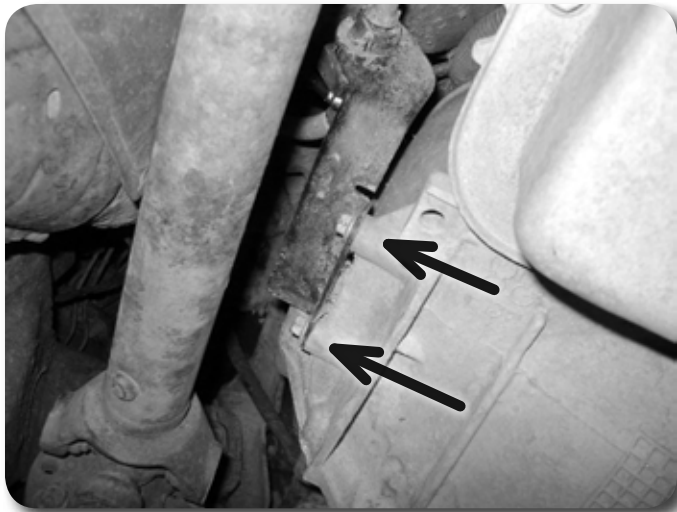

Figure 16A

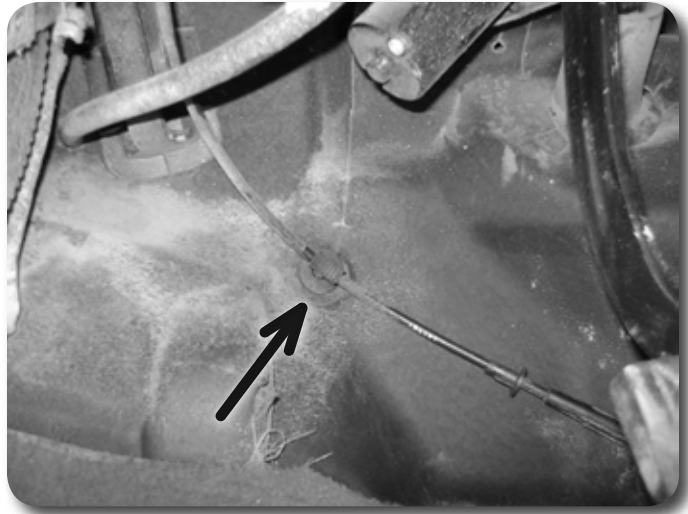

Figure 16B

30. **Manual Transmissions:** Make sure that the transmission is in neutral before lifting the vehicle. No modifications to the shift lever are needed

---

### »» **TRANSFER CASE**

31. The transfer case shift lever should require no modification. As the cab is lifted the lever will fall through the floor .

---

### »» **REAR BUMPER**

32. Remove the license plate lights and any other wires attached to the rear bumper.
33. Remove the four nuts that mount the rear bumper to the frame and separate the bumper from the vehicle. **Figure 17** Save hardware.

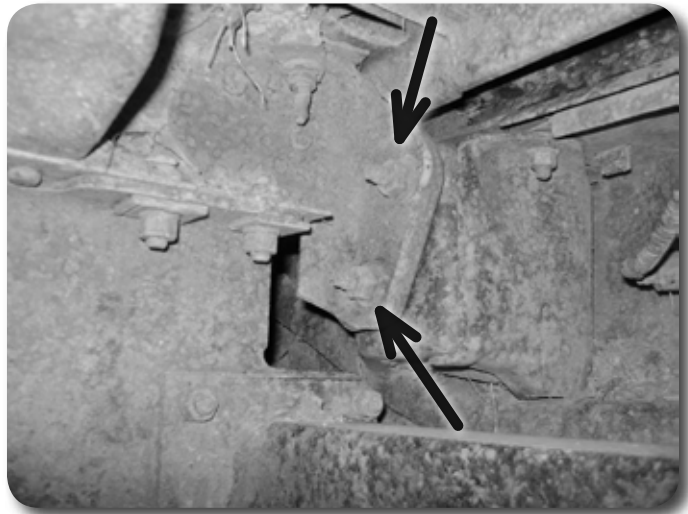

Figure 17

### **Warning**

Gasoline is flammable. Use extreme caution when working around fuel lines and tanks. Any sparks could ignite fuel or fuel vapor, causing an explosion or fire resulting in personal injury or death. Clean up all fuel spills.

---

### »» **FUEL FILLER NECK**

34. Remove the fuel cap. Remove the three screws that mount the fuel filler neck to the body. Save screws.

35. Remove the clamp that holds the fuel filler tube to the bod . **Figure 18** The filler tube will clear everything during the lifting operation and will be removed and extended after the vehicle is lifted.



Figure 18

## » BODY LIFT

36. Loosen but do not remove all of the cab and bed mounting bolts (A T-50 torx socket is required to loosen the bed mounting bolts—Super Crew models require a T-55).
37. Remove the cab and bed mounting bolts on the passenger's side of the vehicle. Using two hydraulic jacks and two wooden blocks slowly lift the cab and bed together just high enough to install the new body spacers. Check for any wires that may be binding or stretching.
38. Remove the front body bushings (near radiator) from the frame mounts. Drill out the threads of the bushing with a 1/2" drill. Reinstall the bushings in the frame and set the new body spacers in place on top of them.
39. Install new mounting bolts with 7/16" USS flat washers in conjunction with factory bushing/washer in the following locations (2" kit length in parentheses): 12mm x 180mm (160mm) in front mount, 12mm x 140mm (120mm) in front floorboard and behind front seat, 12mm x 200mm (180mm) in rear mount of super/crew cabs. Use 12mm x 180mm (160mm) in all bed locations with the provided heavy 1/2" washers. Leave hardware loose.
40. Repeat lifting procedure for driver's side of vehicle. Pay special attention to see that the fuel neck falls through the body. Check bed and cab alignment then tighten cab bolts only. Use Loctite® on all mounting bolts. Torque bolts to 60 ft-lbs.
41. Remove the rear-most driver's and passenger's bed bolts. Remove the factory nut clip from the frame.
42. Locate the three rivets mounting the factory rear bumper brackets to the frame. **Figure 19**

### Step 36 Note

Cab and bed must be lifted simultaneously. Failure to comply could result in significant body damage to both the cab and bed.

The factory body bolts are coated with very strong thread lock. It may not be possible to use air tools to loosen the bolts,

### Step 39 Note

Body bolts are locating in hardware pack #224 or #227. Washers are located in hardware pack #211.

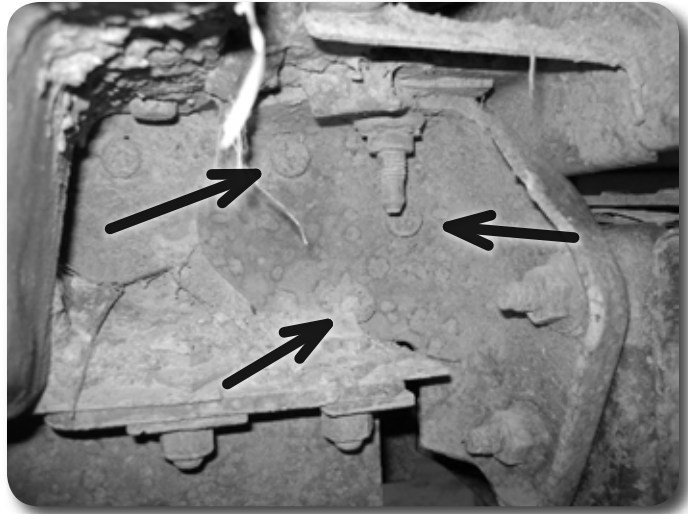

Figure 19

43. Remove the heads of the rivets on the outside of the frame with an air chisel, drill or grinder while taking care not to damage the frame rail. Use a hammer and punch to drive the rivets through the frame and remove the brackets from the vehicle.
44. Install the new driver's and passenger's rear bumper brackets using the provided 7/16" x 1" bolts, nuts and 7/16" USS washers in the factory mounting holes. Do not tighten the hardware at this time.
45. Reinstall the factory nut clips and rear bed bolts. The bed may need to be lifted slightly to reinstall the clip over the frame/bumper bracket and under the body block.
46. Align the bed to the cab and tighten all the bed mounting bolts. The remainder of the bumper installation will be done later.
47. Install the metal body spacers at the four points where the bed cross members rested on the frame. Remove the rubber pads from the frame at the four contact points. Install the metal spacers and align the holes in the spacers with the holes in the frame where the pads were located. Use 3/8" x 1" bolts, 3/8" USS washers, and lock nuts to secure the spacers to the frame **Figure 20**.
48. Check to see that the parking brake cable (driver's side) has enough slack and pulled through the rubber grommet in the floor properly. Make sure that the grommet is still mounted in the floorboard secure.

### Step 44 Note

Rear bumper bracket hardware is located in hardware pack #229.

It may be necessary to drill out the factory mounting holes to accept the 7/16" hardware.

### Step 47 Note

Metal spacer mount hardware is located in hardware pack #211.

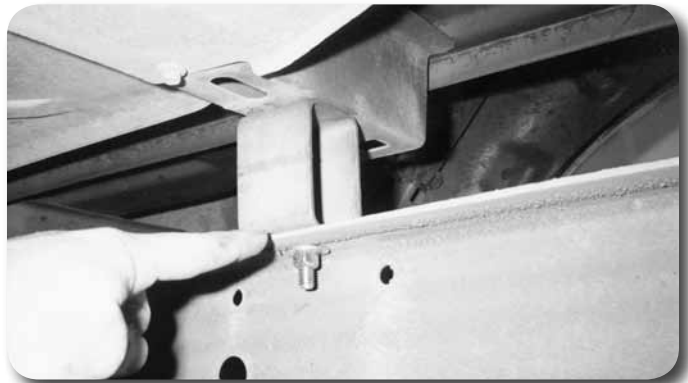

Figure 20

---

## » INTERIOR REINSTALLATION

49. Reinstall the rubber caps over the front cab mounting bolt access holes. Replace carpet to the original position. Install scuff plates and kick panels in reverse of removal.
50. **Super Cab:** Replace carpet to original position. Install the rear seats, scuff plates and kick panels in reverse of removal.
51. **Super Crew:** Replace carpet to original position. Replace jack to original location. Fasten back panel using four stock nuts. Install rear seats, scuff plates, seat belts, and seat mounting bolt covers.

---

## » STEERING

52. Connect the steering extension to the steering shaft (It only goes on one way). Make sure the steering wheel and steering shaft have not moved from their original positions. Using the stock steering bolt tighten the steering extension to the steering shaft (Make sure the bolt runs through the slot in the steering extension).
53. **Vehicles equipped with adjustable pedal option:** Check clearance between the steering shaft and the pedal assembly when the pedals are adjusted all the way to the firewall. If there is contact between the shaft and the pedal assembly CAR - FULLY bend the pedal mounting bracket slightly to the left to provide adequate clearance.

---

## » SHIFT CABLE RELOCATION

### 4.6 Liter Engine

54. Using stock bolts, mount the transmission shift cable relocation bracket to the original cable bracket mounting holes Figure 21.



Figure 21

55. Mount the stock cable bracket to the relocation bracket using two 5/16" x 1" bolts, four 5/16" USS washers, and two 5/16" lock nuts. Tighten all hardware securely.
56. It may be necessary to make some adjustments to the transmission cable to ensure that it operates properly. The transmission shift lever may need to be bent to better align with the new angle of the cable. The shift indicator can be adjusted using the adjustment wheel located under the dash.

### 5.4 Liter Engine

57. Slide the nut up the cable and reattach to the original stud on the firewall. The 5.4 liter transmission does not require any adjustment.

### Step 55 Note

Shift cable bracket hardware is located in hardware pack #211

---

## » SAFETY CABLE RELOCATION

58. On the frame, about 8" forward of the original mounting hole is an existing hole (on both frame rails) where the safety cable can be relocated **Figure 22**.
59. Insert the stock bolt from the inside of the frame. As the bolt is tightened, the locating tab on the cable will flatten out and the cable end will mount flush to the frame.

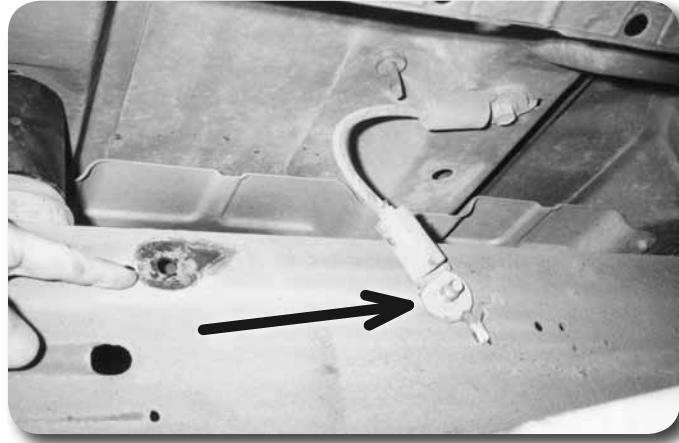

Figure 22

---

## » GROUND WIRE RELOCATION

60. Allow for some slack, locate and drill a 1/4" mounting hole for the ground wire located on the passenger's side frame. Drill the new hole in the metal body mount as shown in **Figure 23**. Attach the ground wire to the new location using a 1/4" x 1" bolt, lock nut and washers.



Figure 23

---

## » FAN SHROUD RELOCATION

*In order to lower the fan shroud the lower mounting tabs must be removed. On some models it may be necessary to remove the radiator to allow for the removal of the fan shroud. In most cases it is possible to remove the mounting tabs without removing the shroud from the vehicle.*

61. Cut the lower fan shroud mounting tabs off flush with the side of the shroud

### Step 60 Note

Ground wire hardware is located in hardware pack #211



62. Mount the fan shroud relocation brackets to the (2) original top shroud mounting points with stock hardware.
63. Mount the shroud on the new studs and secure with 1/4" lock nuts and washers. Attach the lower fan shroud relocation bracket to the core support using the existing bolt that secures the cross member in the center of the support Figure 24A.



Figure 24A

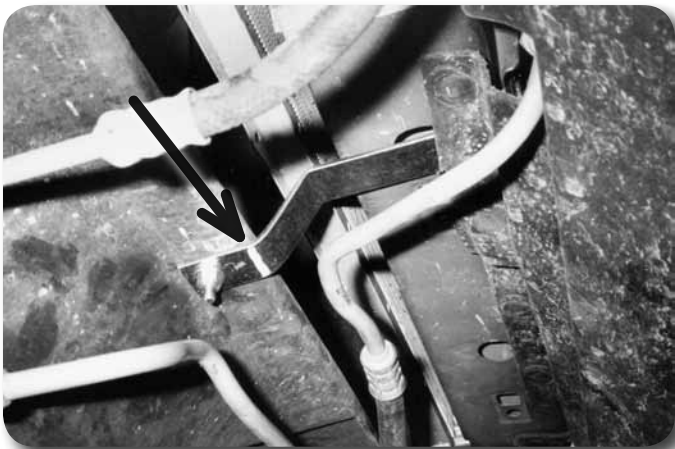

Figure 24B

64. Hold the fan shroud in place and using the lower relocation bracket as a template, mark the hole location on the shroud. Drill a 5/16" hole in the shroud. Attach the fan shroud to the relocation bracket using a 1/4" bolt, nut, and washers.
65. Check for fan-to-shroud clearance.

## » OIL COOLERS

66. Reattach oil coolers to original locations on core support using stock hardware.
67. Carefully bend oil cooler lines as needed to adequately clear the fan shroud.

## » FRONT BUMPER INSTALLATION

68. Mount the front bumper relocation brackets (long, flat bracket with 3 holes) to the stock bumper location with 7/16" x 1-1/2" bolts, lock nuts, and 7/16" USS washers in the lower holes in the frame and bracket.

### Step 63-64 Note

Fan shroud hardware is located in hardware pack #211.

### Step 64 Note

Some models are equipped with fan shrouds that have a lip which wraps around the bottom of the radiator. In this case, measure up 1-1/4" and mark the shroud end of the relocation bracket. Bend the bracket at the mark so the end is parallel to the bottom of the core support Figure 24B.

### Step 68 Note

Bumper hardware is located in hardware pack #211. Do not tighten bumper hardware until the bumper is mounted and adjusted to desired position.

69. Using the stock nuts mount the bumper to the middle and upper holes in the relocating brackets. The lower bumper stud now mounts through the relocating bracket and the frame **Figure 25**.



Figure 25

70. Adjust the bumper to the proper position and tighten all hardware.
71. Reconnect all wires removed from bumper and replace the rubber air flap to its original location.

---

### »» **TOW HOOK INSTALLATION**

72. The front valance must be trimmed if the tow hooks are to be reattached to the frame. Set the tow hook up to the frame, against the valance and mark the valance for trimming.
73. Trim the valance where marked **Figure 26**. The valance can be “sandwiched” in between the frame and the tow hook.
74. Install tow hook in reverse of disassembly.

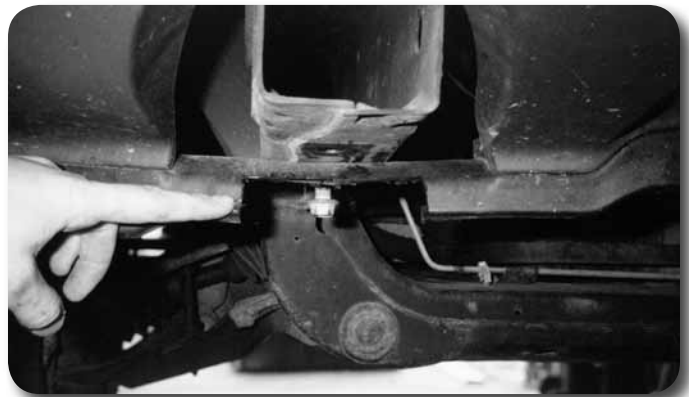

Figure 26

#### **Step 73 Note**

It may be desirable to leave the portion of the valance that is against the frame intact

---

### »» **FUEL FILLER EXTENSION**

75. Loosen the clamps holding the fuel filler and vent hoses to the fuel tank. Remove the filler assembly from the vehicle
76. Loosen the clamp securing the vent hose to the metal vent tube and replace with the new one provided.

77. Cut the fuel filler hose in half below the bottom bend. Using the provided metal extension and two hose clamps, reassemble the fuel filler tube **Figure 27**. Do not tighten clamps at this time.
78. Reinstall the fuel filler assembly in the vehicle. Attach the filler neck to the body with the stock screws. Remount the steel filler tube to the tab on the body using the stock hose clamp. Attach the vent and filler hoses to the fuel tank and adjust the filler extension. Tighten all clamps.



Figure 27

---

## » SPARE TIRE WINCH RELOCATION

79. Lower the spare tire from its stowed position and remove it from the winch. Remove the two bolts securing the winch to the frame cross member.
80. Disconnect the plastic winch crank guide tube and pull it free from the frame. **Figure 28**

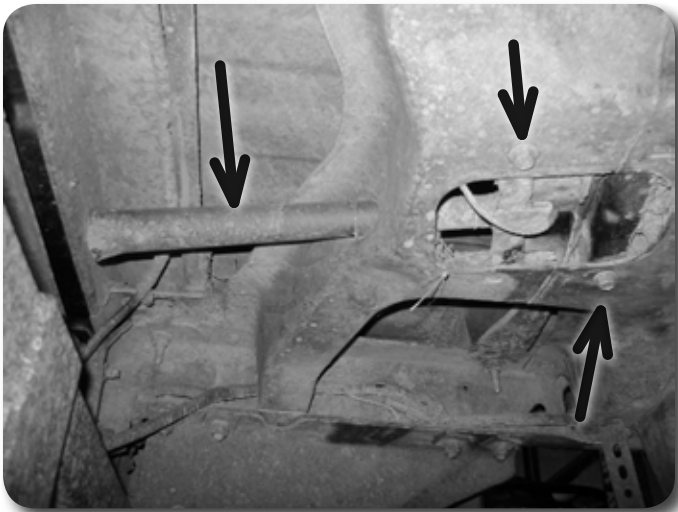

Figure 28

81. Lift the winch from its original position using two 2-1/2" long steel spacers **Figure 29**. Run 3/8" x 3-1/2" bolts with 3/8" washers through the stock mounting holes, through the spacers, and thread into the hoist. Use 3/8" lock nuts on the top side of the hoist to secure the bolts.

**Step 81 Note**  
Spare tire winch hardware is located in hardware pack #211.

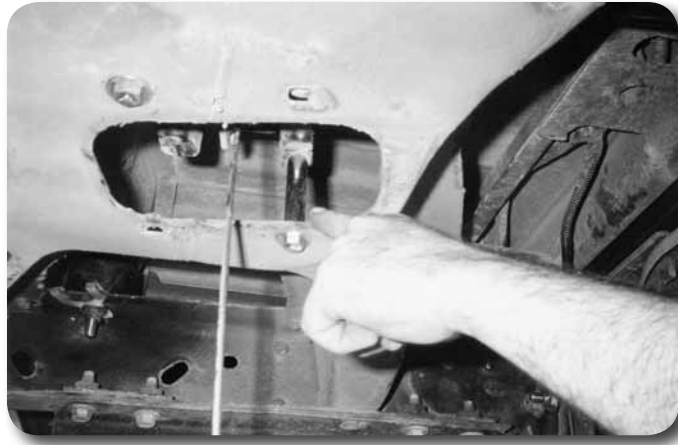
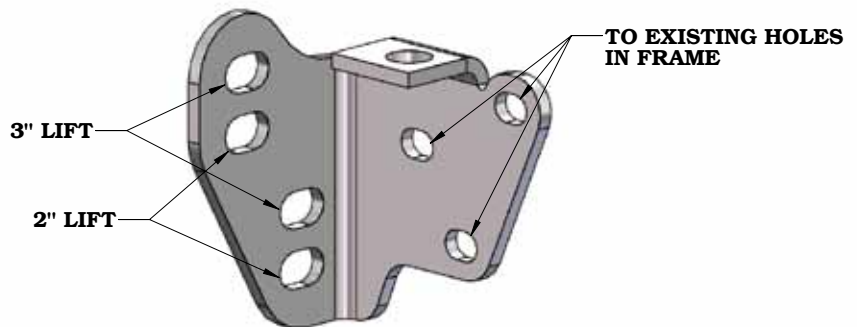

Figure 29

82. Reattach the plastic winch crank guide tube to the winch.

### » REAR BUMPER RELOCATION

83. Mount the rear bumper to the new bumper brackets using the factory nuts. Use the top set of holes for the 3" lift and the lower set for the 2" lift. Leave bumper loose. Figure 30



DRIVER'S SIDE SHOWN

Figure 30

84. Adjust the bumper to the appropriate location and tighten all bracket and bumper mounting hardware.
85. Return spare tire to stowed position.
86. If possible, reattach axle breather in original location. If not, relocate breather to an appropriate location using zip ties provided.
87. Reattach the air intake to the throttle body and secure the hose clamp. Reassemble the air filter box. Replace the throttle body cove .
88. Reconnect the battery cables. Connect positive cable first and then negative cable.

*Note: Check all fasteners for proper torque. Check all fasteners again after 100 miles.*

### Post-Installation Warnings

1. Check all fasteners for proper torque. Check to ensure for adequate clearance between all rotating, mobile, fixed, and heated members. Verify clearance between exhaust and brake lines, fuel lines, fuel tank, floor boards and wiring harness. Check steering gear for clearance. Test and inspect brake system.

2. Perform steering sweep to ensure front brake hoses have adequate slack and do not contact any rotating, mobile or heated members. Inspect rear brake hoses at full extension for adequate slack. Failure to perform hose check/replacement may result in component failure. Longer replacement hoses, if needed can be purchased from a local parts supplier.

3. Perform head light check and adjustment.

4. Re-torque all fasteners after 100 miles. Always inspect fasteners and components during routine servicing.