



**#F9383 Installation Instructions**  
**2004-2005 F-150 5dr/5.4L**  
**3" Body Lift without Factory Receiver**

**Read and understand all instructions and warnings prior to installation of product and operation of vehicle.**

Zone Offroad Products recommends this system be installed by a professional technician. In addition to these instructions, professional knowledge of disassembly/ reassembly procedures and post installation checks must be known. Minimum tool requirements include the following: Assorted metric and standard wrenches, hammer, hydraulic floor jack and a set of jack stands. See the "Special Tools Required" section for additional tools needed to complete this installation properly and safely.

---

**» PRODUCT SAFETY WARNING**

Certain Zone Suspension Products are intended to improve off-road performance. Modifying your vehicle for off-road use may result in the vehicle handling differently than a factory equipped vehicle. Extreme care must be used to prevent loss of control or vehicle rollover. Failure to drive your modified vehicle safely may result in serious injury or death. Zone Offroad Products does not recommend the combined use of suspension lifts, body lifts, or other lifting devices.

You should never operate your modified vehicle under the influence of alcohol or drugs. Always drive your modified vehicle at reduced speeds to ensure your ability to control your vehicle under all driving conditions. Always wear your seat belt.

---

**Difficulty Level**

easy 1 2 **3** 4 5 difficult

Estimated installation: 6-8 hours

**Special Tools Required**

none

**Tire/Wheel Fitment**

33 x 12.50 Tire

---

**» PRE-INSTALLATION NOTES**

1. Special literature required: OE Service Manual for model/year of vehicle. Refer to manual for proper disassembly/reassembly procedures of OE and related components.
2. Adhere to recommendations when replacement fasteners, retainers and keepers are called out in the OE manual.
3. Larger rim and tire combinations may increase leverage on suspension, steering, and related components. When selecting combinations larger than OE, consider the additional stress you could be inducing on the OE and related components.
4. Secure and properly block vehicle prior to installation of Zone Offroad Products. Always wear safety glasses when using power tools.
5. Zone Offroad Products body lifts are designed to be used on vehicles in good operating condition. It is not recommended that body lifts be used on vehicles in poor physical shape. This includes rusted body mounts, damaged or worn frame-to-body mounting brackets, and poor mechanical condition. Perform a visual inspection of the vehicle before beginning installation.

## Kit Contents

**\*Important\* Verify you have all of the kit components before beginning installation.**

Qty	Part	Qty	Part
1	1-1/4" x 0.090 electro weld tube	16	3" x 3" Body Lift Block
2	Rear Bumper Bracket	2	2" x 3" Body Lift Block
2	Front bumper relocation brackets	1	Steering extension
1	Spare tire relocation bracket	4	Hose Clamps #20
1	Emergency brake cable relocation bracket	1	1.00 x 0.05 x 4" Tube
1	Transmission shifter relocation bracket	1	1.313 x .313 x 1.025 sleeve spacer
2	Radiator drop bracket - F 150 - z shaped	2	3" strap w/ 1/4" stud
1	ABS Relocation bracket (with 5/16" studs)	3	2" strap w/ 1/4" stud
2	1/2"-13 x 1-1/2" bolt tabs	1	Bolt Pack
1	1/2" Bolt Fish Wire	4	2" x 3" x 1/8" Steel Bed Spacer
		1	Bolt Pac



## PRE INSTALLATION NOTES

1. The radiator **MUST** be drained and refilled for proper installation. Buy the correct coolant before you begin the installation. Coolant not included in kit.
2. A 9/16" drill bit is needed for installation.
3. T-45 and T-50 torx bits are required in addition to a complete set of sockets, wrenches, and various other tools.
4. Read through all instructions prior to installation.
5. This system will **NOT** work with any suspension system that relocates the rack and pinion.
6. Only fits 2004-2005 model years.

## INSTALLATION INSTRUCTIONS

7. Park the vehicle on a clean, flat surface and block the rear wheels for safety. Leave vehicle in Park.
8. Disconnect the positive and negative battery cables from the battery. The Supplemental Restraint System (airbags) will be deactivated when the battery is disconnected.
9. Measure and recorded the distance between the body and the bed as well as the bumpers to the body. These measures will be used for reference during installation.

---

### »» **INSIDE CAB**

10. Remove the cap from the middle upper seat belt cover to expose the two mounting nuts **Figure 1**. Remove the nuts and the seat belt cover from the top of the seat. Save hardware.



Figure 1

11. Pull up on the seat back to release it from the back wall of the cab and remove it from the vehicle. Use caution: There are sharp edges on the bottom of the seat back that can cause damage.
12. Remove the 4 nuts/bolts that mount the back of the seat frame to the cab floor **Figure 2**. Save hardware.



Figure 2 – pass side shown

13. Flip the seat bottom up and remove the 2 bolts mounting the jack brackets to the floor. Remove jack from vehicle and save hardware **Figure3**.
14. Remove the 3 torx head bolts (T-50) mounting the front of the seat frame to the cab floor. Remove the seat bottom from the vehicle and save hardware.
15. Pull the rear plastic door sill plates up to free the retaining clips and remove them from the vehicle **Figure4**.
16. Remove the plastic rear seat belt covers. They can be pulled off by hand.
17. Remove the rear seat belt mounting bolts (one per side, T-50 socket). Save mounting bolts.



Figure 3



Figure 4

18. Remove the rear middle plastic carpet fastener and save.
19. Pull the carpet up to expose the body mount bolts behind each of the front seats **Figure 5**.
20. Pull the front plastic door sill plates up to free the retaining clips and remove them from the vehicle.
21. Pull the front carpet back to expose the body mount nuts.



Figure 5

---

## » FRONT BUMPER

22. Remove the 3 plastic clips that mount the lower rubber shroud to the front bumper. Allow the shroud to hang down out of the way and save the clips **Figure 6**.



Figure 6

23. Disconnect the fog light wires from the fog lights. Disconnect the wire retaining clip from the bumper Figure 7.



Figure 7

24. Remove the 3 bolts mounting the upper plastic bumper cover to the lower steel bumper. Remove the bolt mounting the hood release to the bumper. Remove the hood cable clip from the passenger's side hood stop bracket. Save all hardware Figure 8.

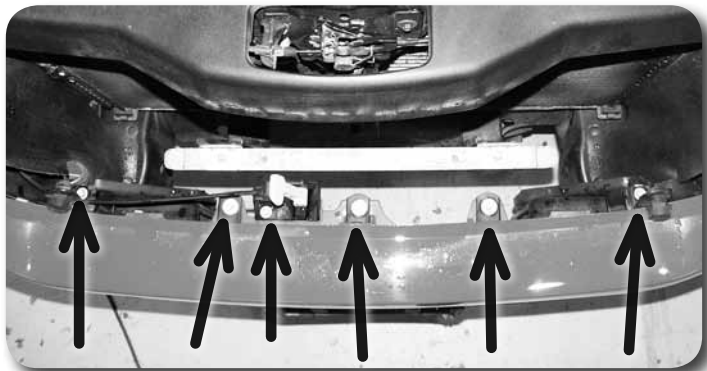

Figure 8

25. Remove the 2 hood stops from the bumper. Save stops and hardware.
26. Remove the 4 nuts mounting the bumper to the frame and remove the bumper from the vehicle Figure 9. Save hardware.



Figure 9 - Drv side shown

---

» **UNDER HOOD**

27. Remove the air intake mounting bolt and remove the intake tube from the vehicle Figure 10.



Figure 10 - shown from drv side

28. Remove the 2 nuts and the intake support bracket from the front of the engine. Save nuts and bracket Figure 11.

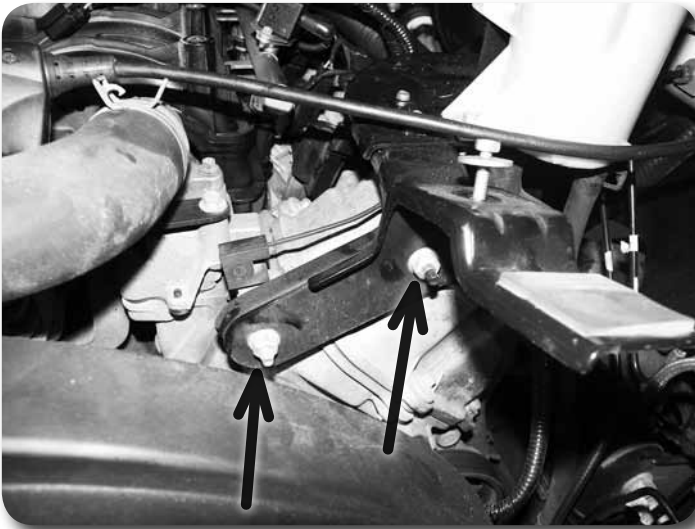

Figure 11

29. Remove the 7 plastic fasteners mounting the plastic core support cover. Remove cover and save along with fasteners Figure 12.



Figure 12

30. Disconnect the side core support rubber shrouds from the frame. There are 2 clips per side Figure 13.

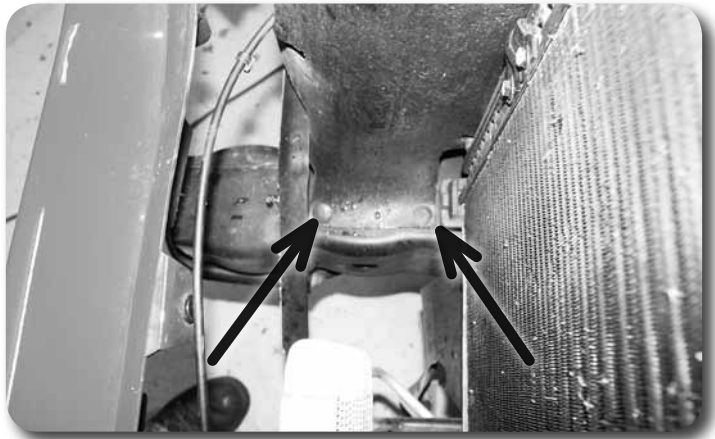

Figure 13 - pass side shown

31. Disconnect the ground wire from the passenger's side firewall Figure 14. Save bolt.

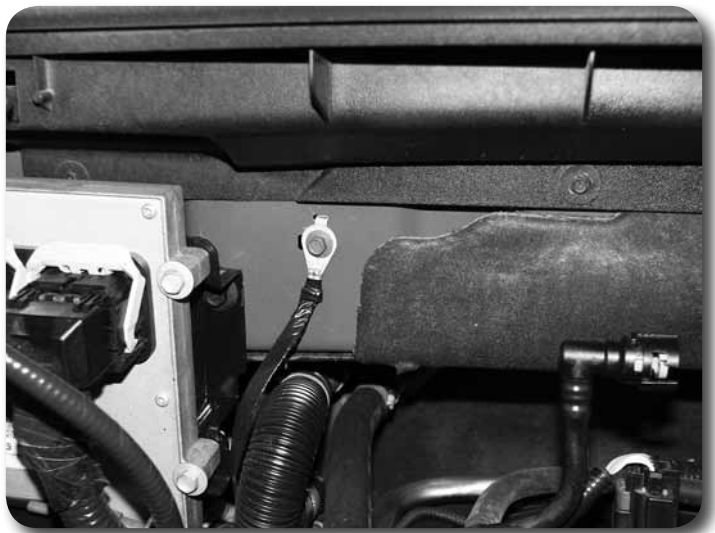

Figure 14



32. Disconnect the 3 wiring harnesses that plug into computer at firewall Figure 15.



Figure 15

33. Disconnect the solenoid from the driver's side firewall Figure 16. Save hardware.



Figure 16

34. Remove the 4 bolts mounting the engine fan to the fan hub Figure 17. Save bolts. Move the fan back against the engine.

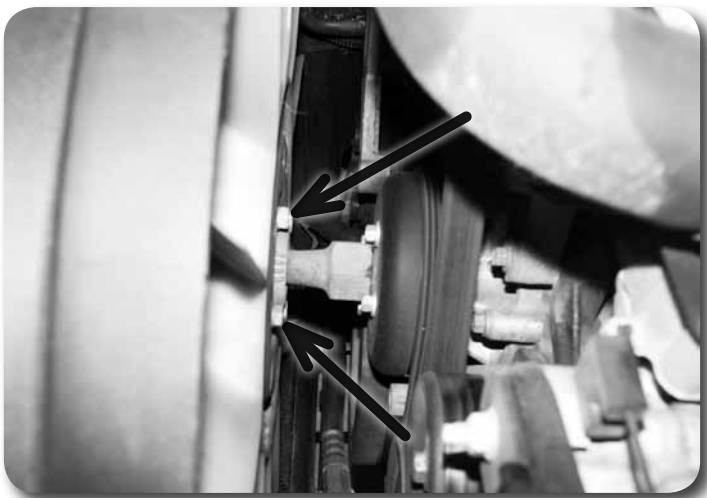

Figure 17

35. Remove the 2 (1 per side) fan shroud bolts **Figure 18**. Save bolts. Pull the shroud up to release it from the lower retaining clips.



Figure 18 – drv side shown

36. Remove the 2 top radiator mounts from the core support **Figure 19**. Save mounts and hardware. Rotate the fan shroud so that driver's side is tilted up while pushing forward on the top of the radiator. Pull the shroud up and out past the fan hub and radiator. Set the shroud aside to be modified later.



Figure 19

37. Drain the radiator into a clean container.
38. Disconnect hose from bottom of coolant reservoir **Figure 20**.
39. Lock the steering wheel. Mark the relationship between the upper and lower portions of the steering shaft at the u-joint **Figure 20**. Remove the pinch bolt and separate the upper and lower shafts. Save hardware.

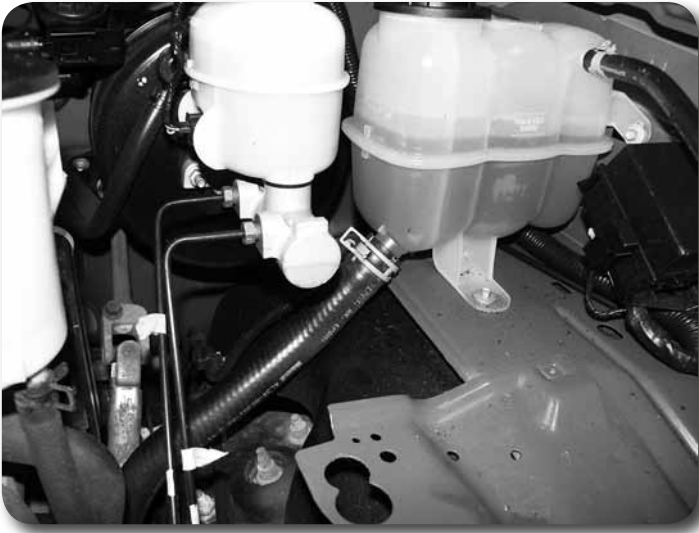

Figure 20

---

» **UNDER BODY**

40. Remove the 3 outer bolts Figure 21 and 1 top bolt Figure 22 mounting the ABS module to the driver's side frame. Save hardware.



Figure 21

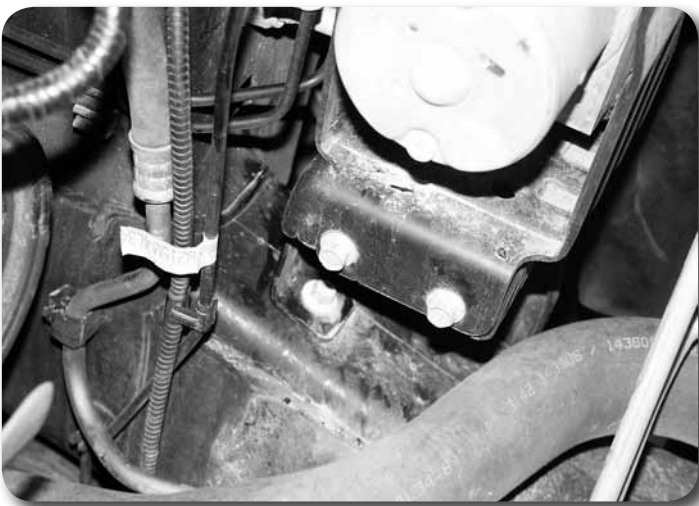

Figure 22

41. Disconnect the ground wire from the body mount located just behind the passenger's side front wheel Figure 34, see lifting body section. Save bolt.
42. Disconnect the shift linkage bracket from the driver's side of the transmission. Save hardware Figure 23.



Figure 23

43. Remove the clips and plastic cover from the driver's side frame rail. Remove the wiring from the clips Figure 24 / 25.



Figure 24



Figure 25

44. Set the parking brake. Clamp the parking brake cable with vise grip pliers at the rear spring hanger and release the brake **Figure 26**. Remove the parking brake cable from the bracket on the frame **Figure 27**.



Figure 26



Figure 27

45. Remove the hose clamp mounting the fuel filler to the bed Figure 28. Save clamp.



Figure 28

46. Remove the three screws mounting the fuel filler neck to the body Figure 29. Save screws.



Figure 29

47. Lower the spare tire and remove it from the vehicle.
48. Compress the retaining tabs on the plastic tube spare tire crank guide and remove the guide from the frame. Save guide.
49. Remove the two bolts mounting the spare tire winch to the frame and remove it from the vehicle Figure 30. Save hardware.

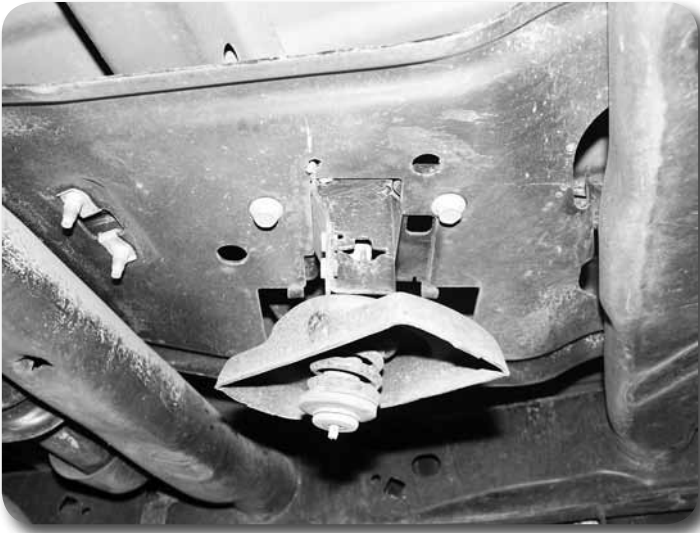

Figure 30

---

» **REAR BUMPER**

50. Disconnect the license plate lights from the rear bumper Figure 31.

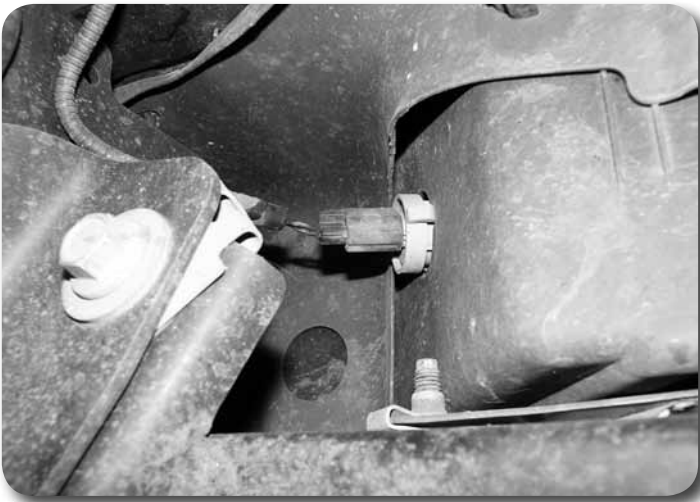

Figure 31

51. Disconnect the trailer wiring from the bumper as well as the wire loom clip if present Figure 32.
52. Remove the bumper from the vehicle Figure 32 / 33. Save hardware.



Figure 32



Figure 33

---

## » LIFTING BODY AND BED

### Lifting Body & Bed Notes

You will NOT be able to unthread the bolts at P-2, D-2, and D-4. They are pressed into the bushings and must be removed by removing the mount and pressing them out.  
Figure 34 / 35 / 36.

### Loctite

Use supplied loctite on all threads during assembly.



Figure 34



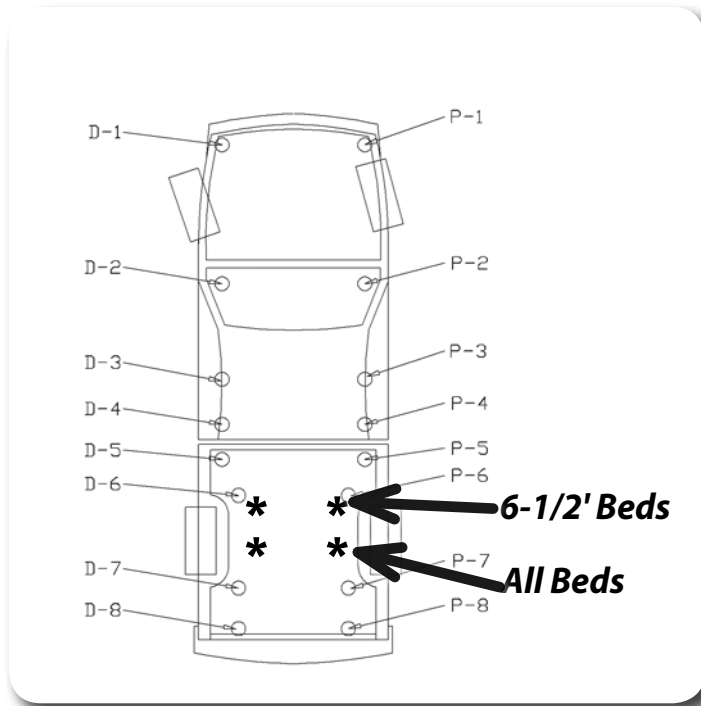

Figure 35

53. Remove torx plus head bolts (P-6, 7, 8, D-6, 7, 8). Note: A specific tool is available to fit these bolts. Spray penetrating oil on all the nuts / nut clips that go to the bed bolts. Do NOT use an impact to break bolts loose.
54. Remove 2 bed mounts that run from bottom up at front of bed (P-5, P-6).
55. Slide bed back 2" to 3" enough to allow cab to be lifted.
56. Remove nut from mount located in front of wheel well on both sides (P-1, D-1). Remove bolt that is threaded into the body mount.
57. Remove nut from mount located at front seat floor board on passenger's side (P-2), and loosen the driver's side (D-2).
58. Remove nut from P-3, loosen nut at D-3.
59. Remove bolt from P-4, remove nut from D-4
60. Lift only one side of body at a time. Check for items that may cause binding, stretching, or interference.
61. Slowly lift passenger's side of body. Remove front mount (P-1) located just in front of wheel well. Remove 2 nuts from bottom of mount just behind the wheel well (P-2). Lift the body enough to allow for removal of both mounts.
62. Put P-1 mount into a vise and drill out to 1/2". It is easiest to drill from the 'top - down' as orientated in vehicle.
63. P-2 bolt must be pressed out of the body mount. Place mount as shown into press to allow bolt to be removed. If plastic cap is present on end of threads, it must be removed first **Figure 36**.

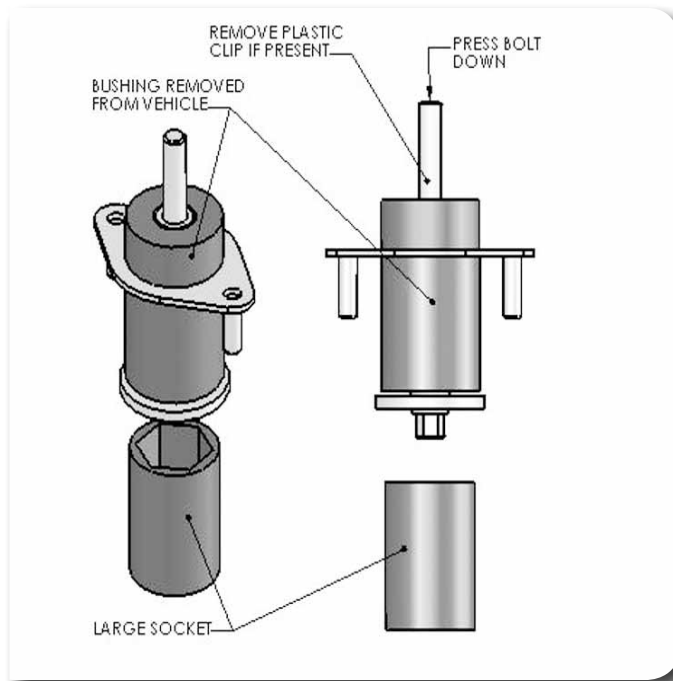

Figure 36

64. Once the two mounts have been modified, reinstall the mounts. The body must be tilted to allow for removal of body mounts with pressed in bolts.
65. Lower passenger's side of body, place bolts through body mounts, but do NOT install hardware at this time, the bolts will be removed again shortly. Remove remaining driver's side bolts.
66. Lift driver's side of body and remove mounts located at D-1, D-2, and D-4.
67. Drill D-1 mount to 1/2", press bolts out of body mounts at D-2 and D-4 locations.
68. Reinstall mounts with 3" tall body lift blocks at all 4 locations.
69. Install bolts as follows:
  - D-1: 1/2" x 9" grade 8 with 1-3/8" OD x 1/2" ID x 3/16" thick washer from top-down
  - D-2: 1/2" x 9" grade 8 from bottom up, use a 1-3/8" OD x 1/2" ID x 3/16" washer on top
  - D-3: 12mm x 220mm bolt from top down
  - D-4: 1/2" x 10" grade 8 bolt from bottom up
70. Lift passenger's side of body. Install lift blocks at P-1, P-2, P-3, and P-4.
71. Install bolts as follows:
  - P-1: 1/2" x 9"
  - P-2: 1/2" x 9"
  - P-3: 12mm x 220mm
  - P-4: 12mm x 240mm
72. Attach frame strap located at P-2 to body with new sheet metal screw.
73. Slide bed forward slightly, have an assistant help lift one side of the bed at a time, place 3" diameter x 3" tall blocks at noted positions (P-5, 6, 7, 8, and D-5,6,7,8). Check body gaps from bed to body, adjust if necessary.

### Step 69,70 Note

All body mount hardware is located in hardware pack #267.

### Step 72 Note

#12 sheet metal screw is located in hardware pack #267.

74. Run 10mm x 100mm bolt with 10mm washer from bottom up at position P-5 and D-5, use loc-tite on threads.
75. Attach 12mm x bed bolts through lift blocks at P-6,7,8 and D-6,7,8 with Loc-tite. Use large diameter (1-3/4" OD) x 3/16" thick washer at each location.
76. Attach metal overload spacers (\*) to bed **Figure35** with 3/8" hardware. Insert bolt with washer as shown **Figure 37a & 37b**.
77. Recheck body gaps and tighten 12mm and 1/2" hardware to 65 ft-lbs, 10mm and 3/8" hardware to 35 ft-lbs.



Figure 37a

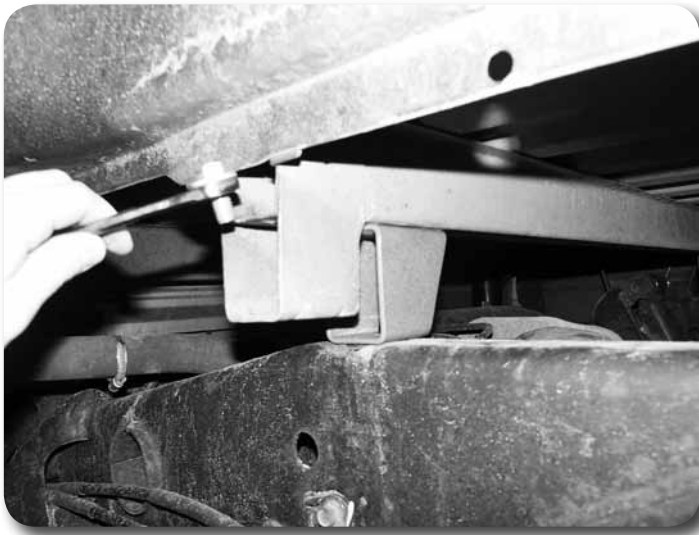

Figure 37b

### Step 74,75 Note

10mm and 12mm bed hardware is located in hardware pack #267.

### Step 76 Note

3/8" bed overload spacer hardware is located in hardware pack #BP123401.

## » REAR BUMPER:

78. Measure 3" above existing lower slot on frame bumper mounting bracket. Drill hole to 9/16".
79. Measure 3" below existing upper slots on bumper bracket. Drill hole to 9/16".  
**Figure 38**
80. Place relocation bracket onto frame bracket, ensure that hole that was just drilled lines up with a slot.
81. Install bumper with OE hardware and new 1/2" x 1-1/2" bolt, washers, and nut.

### Step 81 Note

Rear bumper hardware is located in hardware pack #509.

82. Check gaps as measured before, adjust as necessary.  
*Note: There will be 1/4" more gap due to relocation brackets.*
83. Tighten 1/2" and 12mm hardware to 65 ft-lbs.

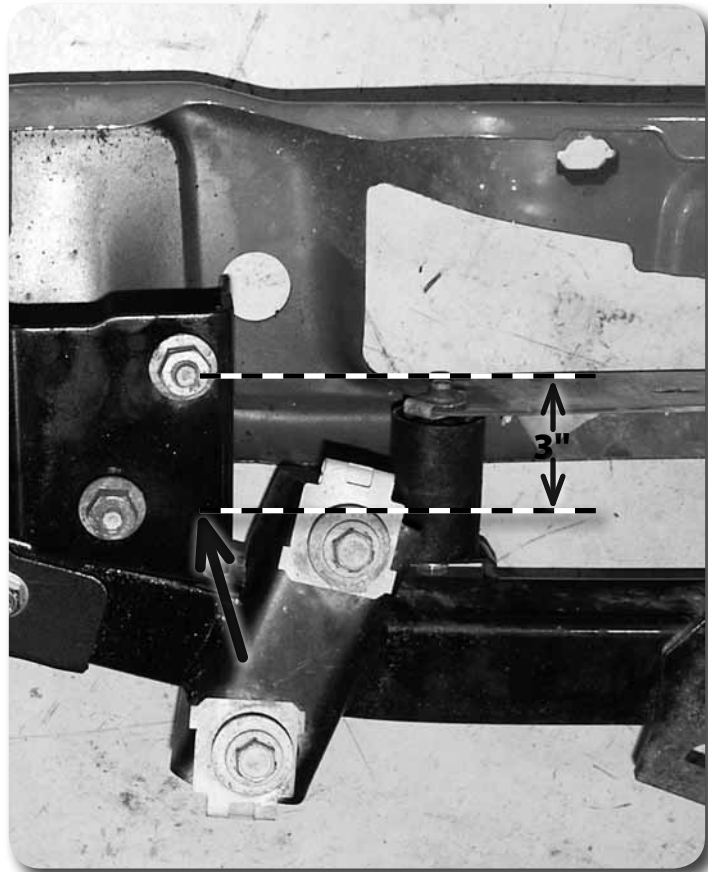

Figure 38

### Step 84-87 Note

Spare tire winch relocation hardware is located in hardware pack #268.

### » SPARE TIRE RELOCATION:

84. Space original winch mount up 3" with 2" diameter x 3" tall blocks and provided 10mm x 100mm bolts and washers **Figure 39a**.
85. Cut the spare tire crank guide tube bracket off flush with the back edge of the winch mount plate. **Refer to Figure 30**.
86. Place the new provided crank guide tube bracket on bottom of spare tire winch mounting plate. Align the new bracket with the cut edge of the original bracket to locate the new mounting hole. Mark hole center and drill to 1/2".
87. Attach relocation bracket to the top of the winch mounting plate with 1/2" x 1" bolt with nut and washers. Check alignment of bracket by installing guide tube **Figure 39b**. Once alignment is good, tighten 1/2" hardware to 65 ft-lbs.
88. Reinstall spare tire.



Figure 39a



Figure 39b

---

» **EMERGENCY BRAKE CABLE RELOCATION BRACKET:**

89. Position bracket over OE mount. Align holes with bracket and attach with  $\frac{1}{2}$ " x 1" bolt, nut and washers through old cable position **Figure 40**.
90. Attach bottom hole to OE mount with  $\frac{5}{16}$ " x  $\frac{3}{4}$ " self tapping bolt, tighten to 20 ft-lbs. Torque  $\frac{1}{2}$ " hardware to 65 ft-lbs.
91. Install cable into relocation bracket.

**Step 89-91 Note**

E-Brake bracket hardware is located in hardware pack #298.

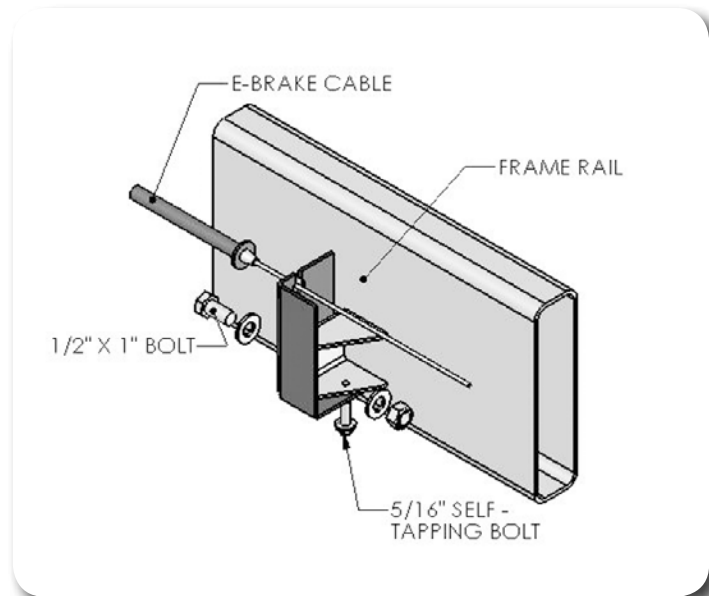

Figure 40

### » FUEL FILL EXTENSION:

92. Cut fuel fill rubber hose 2~3" from end where it meets the metal extension Figure 41.
93. Insert 1-1/4" OD sleeve into tube. Attach with #20 hose clamps.
94. Reattach fuel fill to bed with OE hardware.

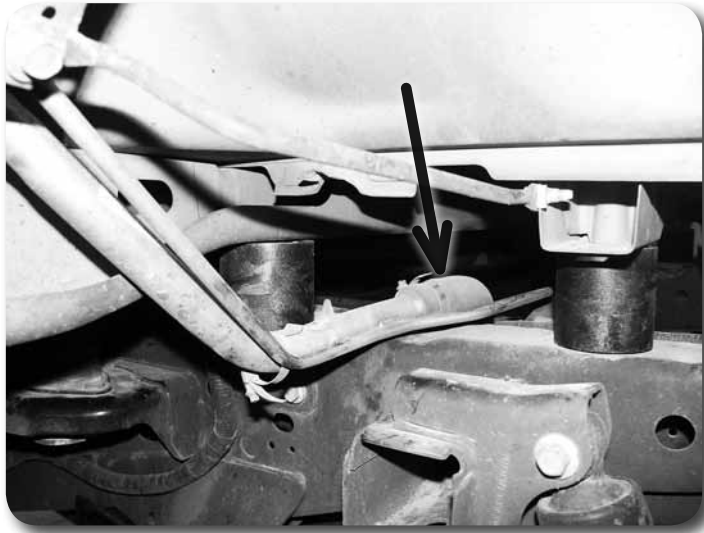

Figure 41

### » TRANSMISSION CABLE RELOCATION BRACKET

95. Place transmission relocation cable to side of transmission, such that studs face out. Figure 42a / b Attach with OE bolts.
96. Attach cable bracket to relocation bracket using the studs in the bracket. Secure with 5/16" nuts and washers.
97. There should be no tension on the cable when the vehicle is in park. Slight adjustment of bracket may be needed to defeat the neutral start safety switch.

#### Step 96 Note

Transmission cable bracket hardware is located in hardware pack #268.



Figure 42a



Figure 42b

---

### » ABS MODULATOR:

98. Place relocation bracket with studs aligned with top 2 holes. Mark 2 hole centers to be drilled through the OE bracket. This will shift the bracket up 1-1/2" **Figure 43.**
99. Drill holes to 7/16", these holes will be exactly 1-1/2" below the top 2 holes. Note: it may be easier to drill by removing the OE bracket from bottom of ABS modulator, disconnect the 3 bolts that connect top to bottom bracket.
100. Attach lower hole of relocation bracket to frame rail with OE bolt.
101. Place OE bracket on top of relocation bracket. Attach studs to existing holes with 5/16" nuts and washers. Attach lower 2 holes to OE frame rail holes with OE bolts.
102. The bolt that ran from top-down will no longer be reused.

#### **Step 101 Note**

ABS bracket hardware is located in hardware pack #268.



Figure 43

---

» **RADIATOR SHROUD:**

103. Radiator must be drained (see service manual).
104. Disconnect upper radiator hose from radiator.
105. Trim edges on radiator shroud as shown in figure. Notch passenger's side of mount to clear relocation bracket as shown Figure 44 a / b.

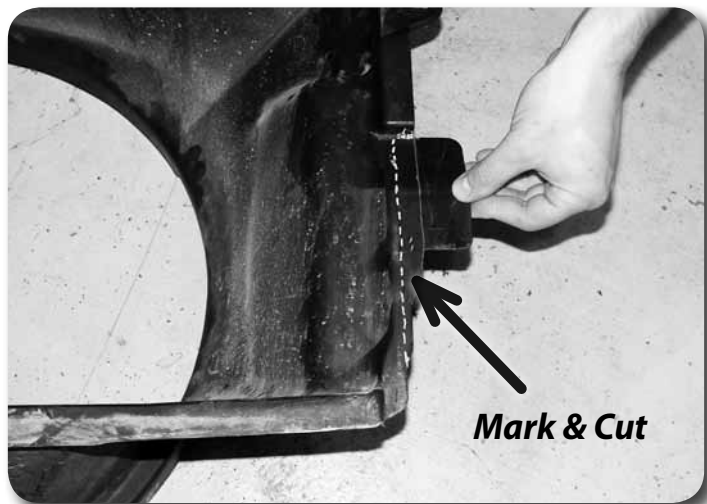

Figure 44a



Figure 44b



106. Remove transmission cooler lines from retaining clip. Form transmission cooler lines to clear radiator shroud by bending them towards the driver's side. Use caution not to kink the lines.
107. Install 3" drop straps onto top mounts **Figure 45**, do not attach with nuts and washers. Note: Make sure the correct OE bolt is used.



Figure 45

108. Test fit radiator shroud to make sure it will clear transmission cooler lines. Re-form lines if necessary **Figure 46**.
109. Attach z-shaped brackets to existing holes where OE clips used to be, below radiator, as shown. Attach with 5/16" self tapping bolts and fender washer. Make sure that the original air deflector guard is pinched between fender washer and bottom of radiator bracket **Figure 46**.
110. Mark slot centers on inside of radiator shroud, remove shroud and drill holes to 3/8".
111. Reinstall radiator shroud, do not attach to brackets, the shroud may need to be moved slightly to attach the fan
112. Attach fan to hub with OE bolts.
113. Attach radiator shroud to z-shaped brackets with 1/4" x 1-3/4" bolts, with fender washers between bolt head and plastic. Use 1/4" USS washer between z-shaped bracket and 1/4" nut **Figure 46**.

### Step 109-113 Note

Fan shroud mount hardware is located in hardware pack #268.



Figure 46

---

### » STEERING EXTENSION:

114. Install steering extension onto male part of shaft, attach with 3/8" x 1" allen head bolt. *Figure 47*
115. Align previous marks and attach female OE shaft to steering extension. Attach with OE bolt.
116. Install 1/4" set screw into steering extension and snug tight.
117. Tighten 3/8" and 10mm bolt bolts to 30 ft-lbs

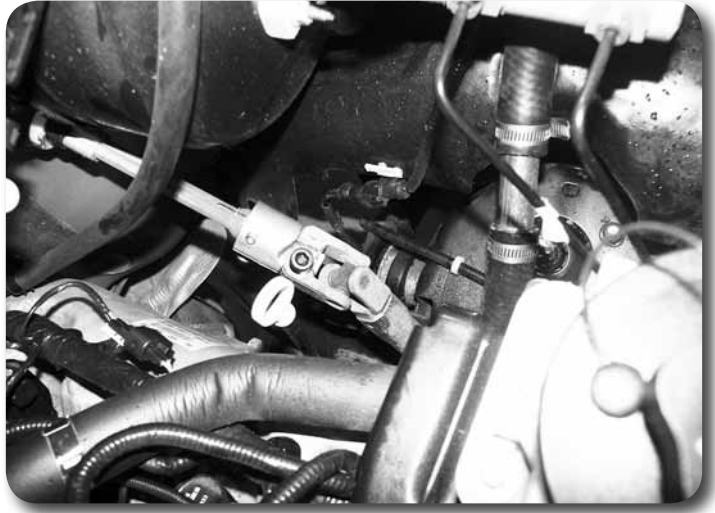

Figure 47

---

### » RESERVOIR HOSE

118. Cut reservoir hose 4" from reservoir end *Figure 47*.
119. Install 1" OD sleeve and attach with #20 hose clamps.
120. Reattach to reservoir.

---

### » FIREWALL

121. Reattach the 3 plugs that go into the computer *Figure 48*.
122. Install 2" drop bracket for the ground strap on the passenger's side with OE bolt and new 1/4" nut and washer Use serrated edge washer as shown to bite into the strap. Failure to do so may result in a poor ground. *Figure 48a, 48b*.

#### **Step 122,123 Note**

Ground strap and solenoid relocation hardware is located in hardware pack #268.



Figure 48



Figure 48b

123. Relocate driver's side solenoid with 2" long straps with studs Figure 49.
124. Attach bracket with OE bolts and new 1/4" nuts and washers.



Figure 49

» **FRONT BUMPER:**

125. Measure on inside of bumper mounting bracket 2-3/4" and mark a vertical line. Measure and mark a line 2" up from center of slot. Cut area out with sawzall, cutoff wheel, or plasma cutter **Figure 50**.
126. Mark holes 3" above OE slot. Drill to 9/16" **Figure 50**

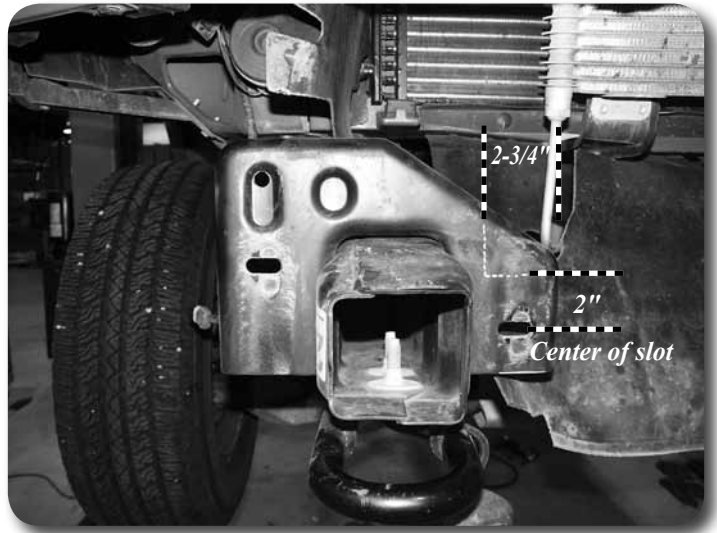

Figure 50

127. Attach relocation bracket to backside of mounting bracket. Attach with 1/2" x 1-1/4" grade 8 bolt, washers, and nut. Run the bolt from front to back **Figure 51**.

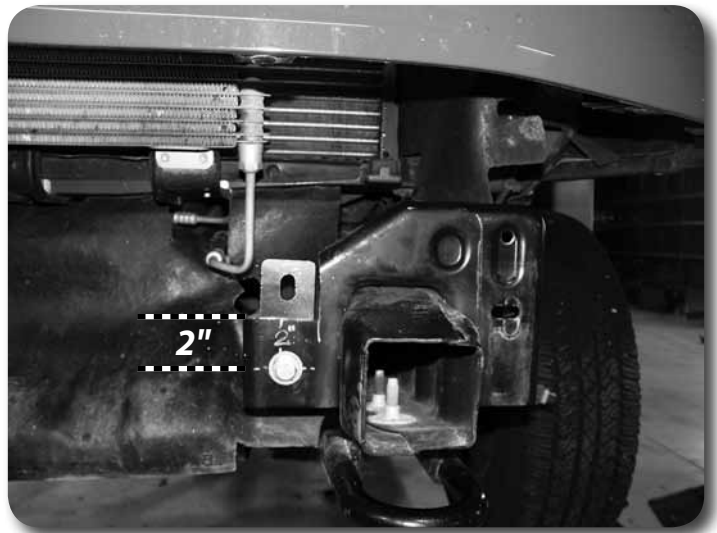

Figure 51

128. Temporarily install bumper and mark slot center onto inner bumper plate that is mounted to bumper. Remove bumper and drill holes to 9/16". **Figure 52a & Fig 52b**

**Step 128 Note**

The lower plastic valance will now be between the tow hook and frame rail.



Figure 52a -bumper bracket shown

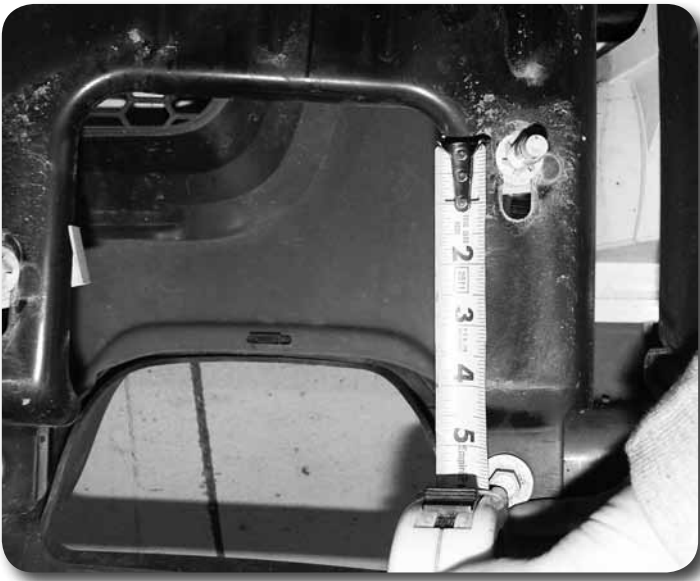

Figure 52b

129. Reinstall bumper after drilling holes with 3/16" thick spacer washers between bumper and relocation plate. Attach with OE hardware.
130. Thread 'fish wire' bolt puller through lower slot and hole drilled in bumper bracket. The head of the bolt will be on the inside of the bumper (where a wrench will not fit.) Figure 53 a / b

### **Step 129-131 Note**

Front bumper hardware is located in hardware pack #268.



Figure 53a



Figure 53b

131. Attach a supplied 1/2" bolt tab to the fish wire and pull from front to back through hole drilled and slot in bumper bracket. Unthread fish-wire and attach with 1/2" washer, lock washer and regular nut.
132. Check bumper gaps and adjust if necessary. Tighten hardware to 65 ft-lbs.
133. Reconnect fog lights – if equipped.
134. Reconnect bumper to grill by installing OE bolts Figure 54.
135. Reattach hood release Figure 54.
136. Reinstall lower hood stops.
137. Reattach the front of the lower air deflector to the backside of bumper cross member using OE push pins. (See radiator shroud steps).

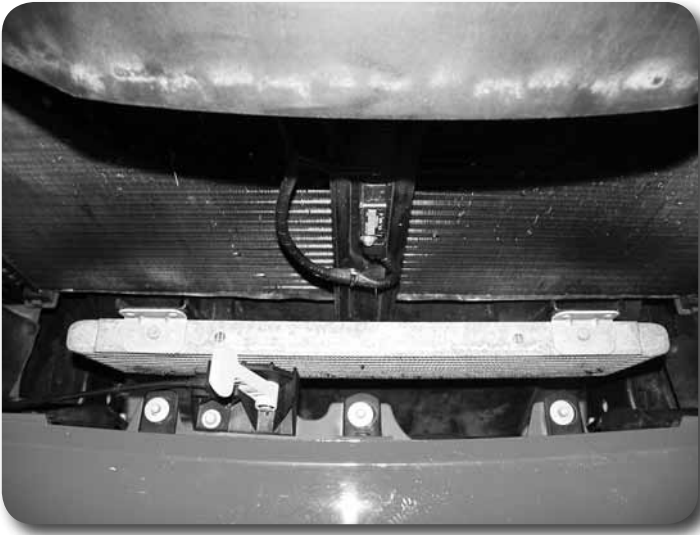

Figure 54

---

» **FINAL STEPS:**

138. Reinstall air intake duct support bracket on front-side of engine with OE nuts  
See disassembly – Fig 11
139. Install upper radiator plastic cover with push pins. Note 2 of these that attached to the radiator shroud will NOT be reused Figure 55.



Figure 55

140. Reinstall air intake duct. Use new 6mm x 50mm bolt with ¼" USS washer and 1" spacer between intake and support bracket. Figure 56

**Step 140 Note**

Air duct hardware is located in hardware pack #268.

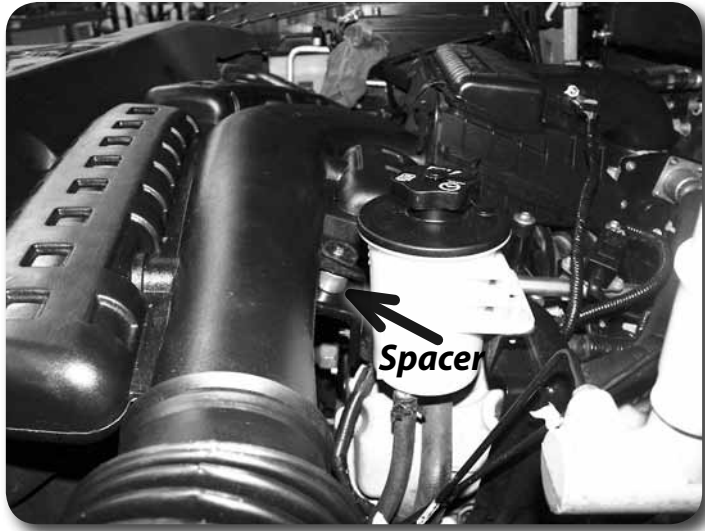

Figure 56

## Post-Installation Warnings

1. Check all fasteners for proper torque. Check to ensure for adequate clearance between all rotating, mobile, fixed, and heated members. Verify clearance between exhaust and brake lines, fuel lines, fuel tank, floor boards and wiring harness. Check steering gear for clearance. Test and inspect brake system.
2. Perform steering sweep to ensure front brake hoses have adequate slack and do not contact any rotating, mobile or heated members. Inspect rear brake hoses at full extension for adequate slack. Failure to perform hose check/replacement may result in component failure. Longer replacement hoses, if needed can be purchased from a local parts supplier.
3. Perform head light check and adjustment.
4. Re-torque all fasteners after 100 miles. Always inspect fasteners and components during routine servicing.

141. Reconnect radiator hose, refill radiator per manufacturer's standards. Make sure the correct coolant type is used, do not mix coolants.
142. Reconnect battery
143. Start vehicle to confirm that transmission relocation bracket is in correct position. If not, adjust until neutral start safety switch allows vehicle to start. There should be no tension on cable when vehicle is in park.
144. Follow coolant refill procedure according to service manual.
145. Recheck all fasteners for proper torque.
146. Check all cables, hoses, and wires for clearance and they are properly connected.
147. Turn steering wheel from lock to lock to verify no interference.
148. Test drive vehicle and check transmission through all gear options.
149. Recheck all fasteners after 500 miles and at regularly scheduled maintenance intervals.