

CONTENTS

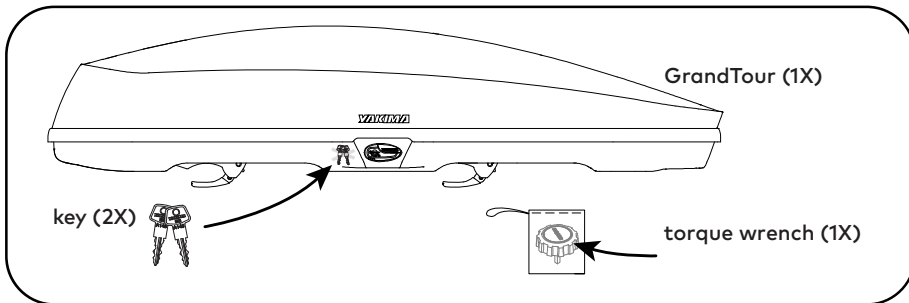

CROSSBAR SPREAD

GrandTour 16 24-36"
GrandTour 18 24-38"

LOAD CAPACITY

box weight



GrandTour 16 = 51 lbs. (23.1 kg)
GrandTour 18 = 58 lbs. (26.3 kg)



rack weight

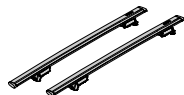

box contents
contenu de la caisse

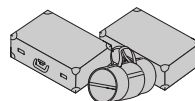

**Not more than 165 lbs. (75 kg)
unless otherwise noted.**

INSTALLATION

1 POSITION THE BOX ON YOUR CROSSBARS.

- Open the cargo box.
- The keys are taped to box. Remove them, insert a key, and turn it counter-clockwise.
- Rotate the handle and lift the lid to open the box—you will hear a “pop”.
- The lid will open both ways for ease of installation but the box should only be opened one side at a time.

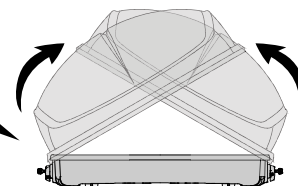
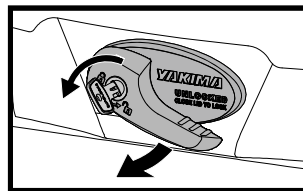

NOTE: The opposite side of the box must be fully closed (listen for a “click”) with the key removed in order to open the other side.

Note: This bolt is not related to installation.

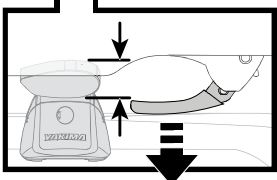
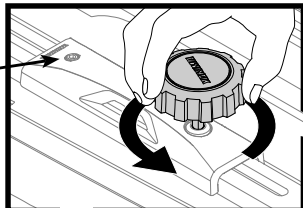

- Remove the wrench from the bag and loosen the bolt on each of the clamps until the clamps are open just enough to fit around your crossbar.
- Reach under the box to move the clamps and slide them all the way forward.
- Close the lid of the box.

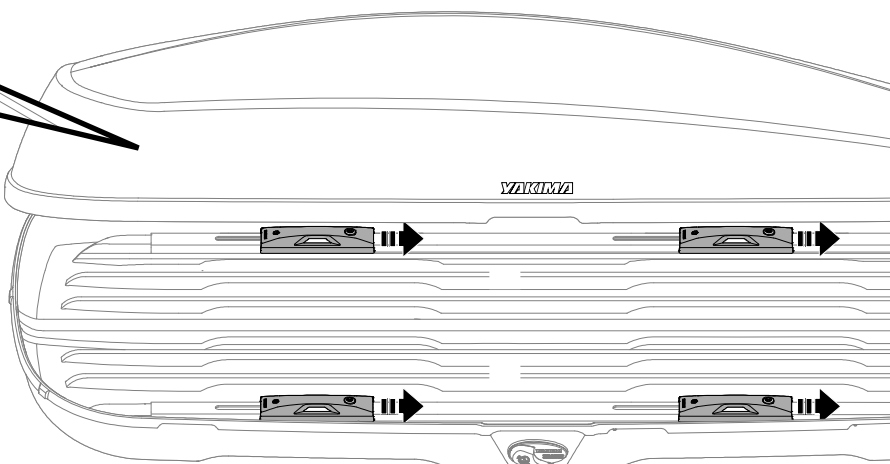

- With the assistance of a friend, lift the box onto your crossbars. Place the box so that the clamps are just a little forward of the crossbars.

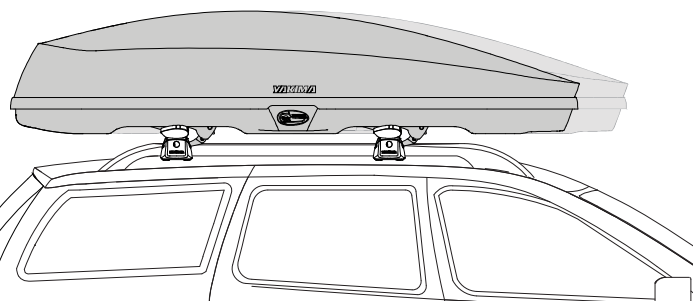
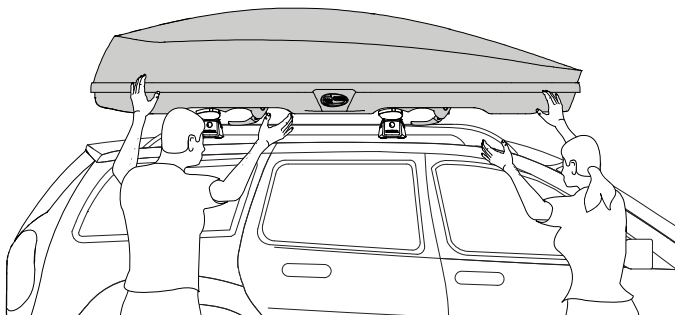

- Slide the box back so that the box is centered on your crossbars.
- Be sure the box is on straight and that your rear hatch does not interfere with its placement.

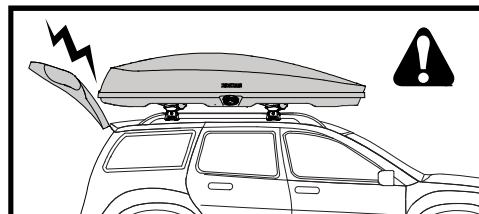
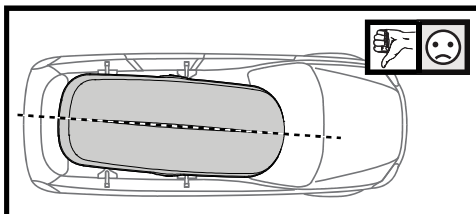
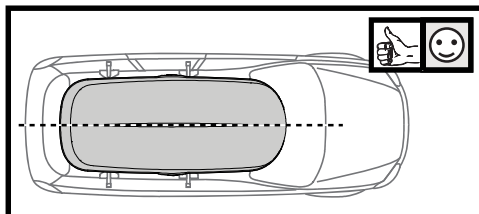

- Slide each clamp backward into position over your crossbars.
- Align the front clamps to each other, and the rear clamps to each other.

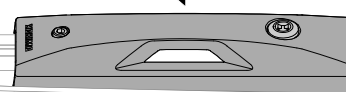
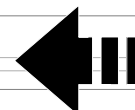
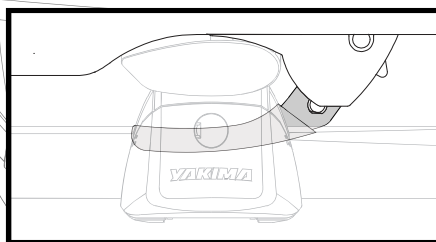

2 TIGHTEN THE CLAMPS.

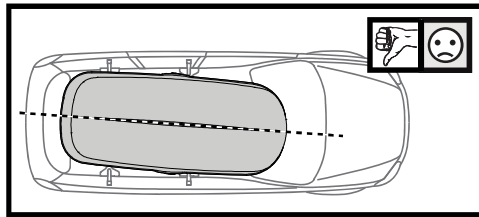
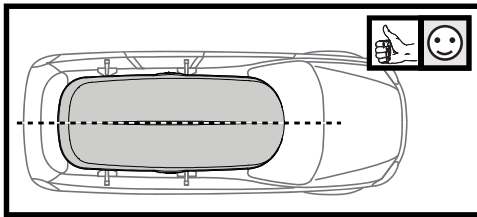
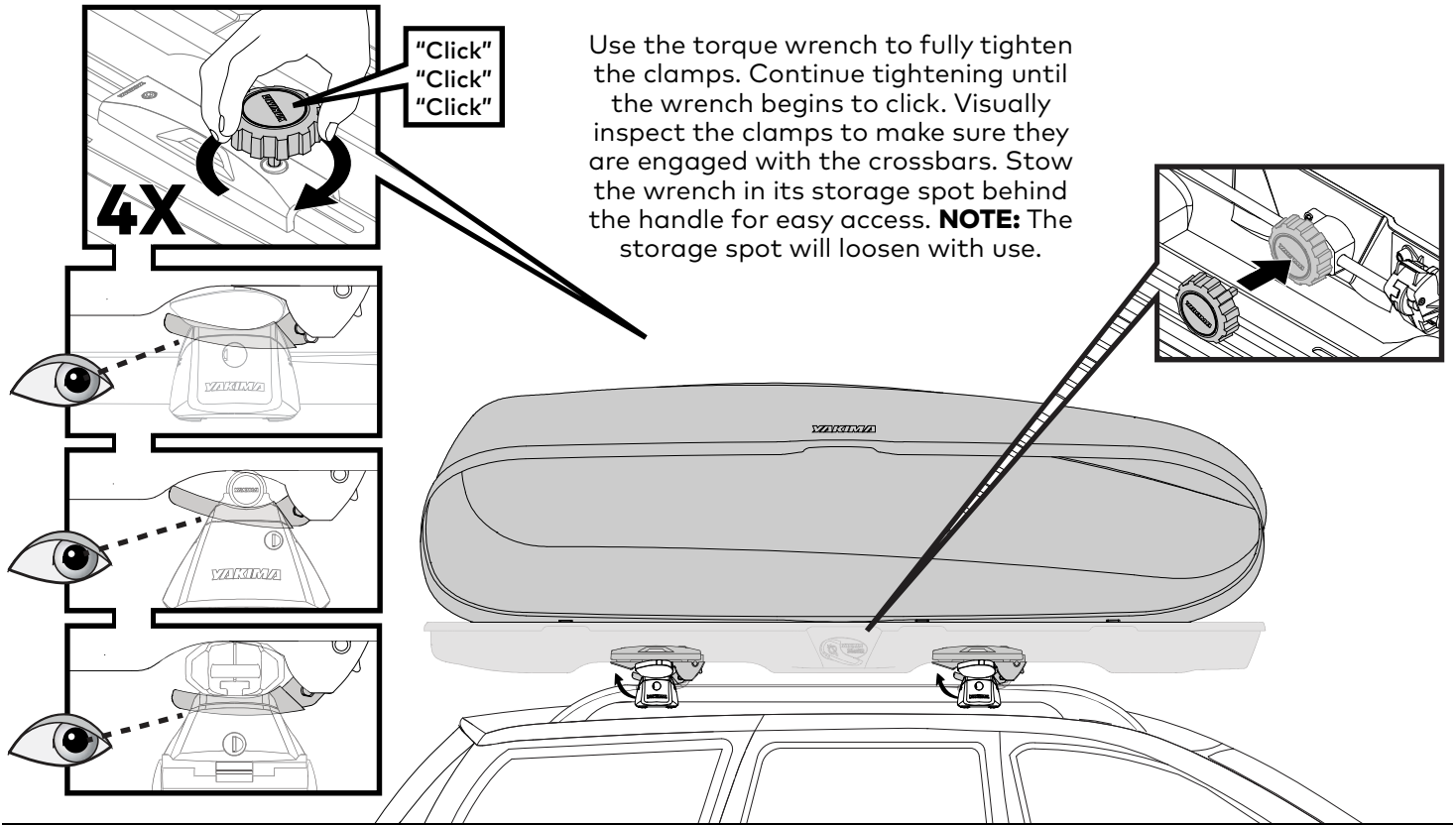

3 CLOSE THE BOX.

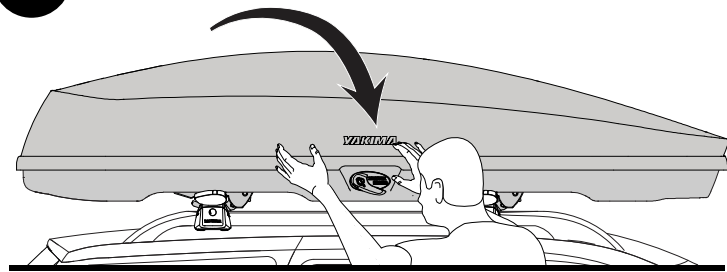

Push the lid down until the handle returns to a horizontal position and you hear a "click". The handle must return to the horizontal position to lock the box and remove key.

Verify closure by pushing up on lid at both ends.

Note: The key cannot be removed unless lid is fully closed.

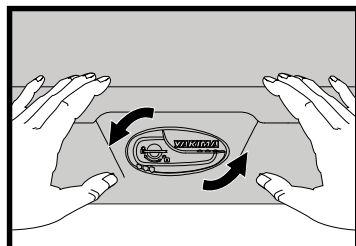
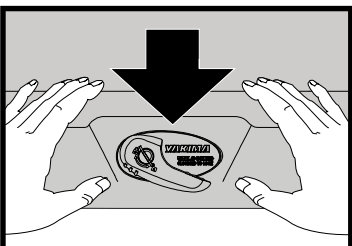

4 TEST THE INSTALLATION.

Test that the box is securely installed by tugging at it in all directions. The box should not slide on the crossbars. Repeat installation step 2 if necessary.

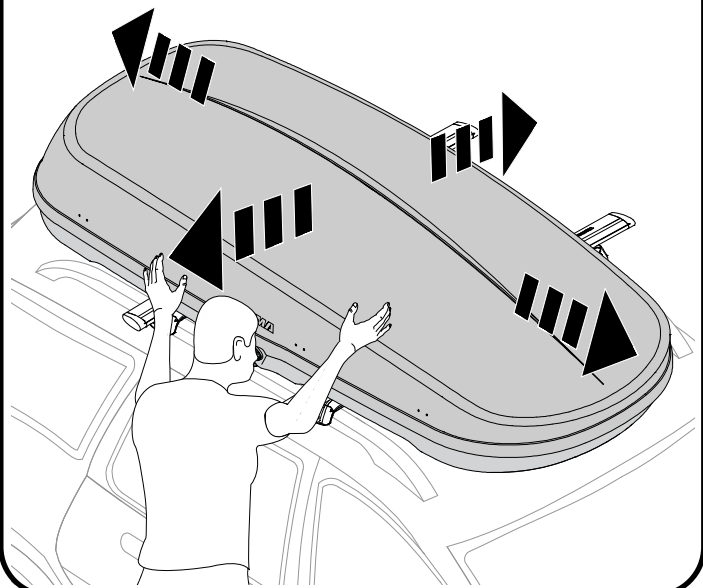

LOADING

1 LOAD YOUR GEAR.

- Unlock and open the box.
- Load your gear.
- Position heavier items in the center of the box.
- Do not overfill the box.
- There are tie-down points on each of the clamps. Use straps (sold separately) for additional load security.

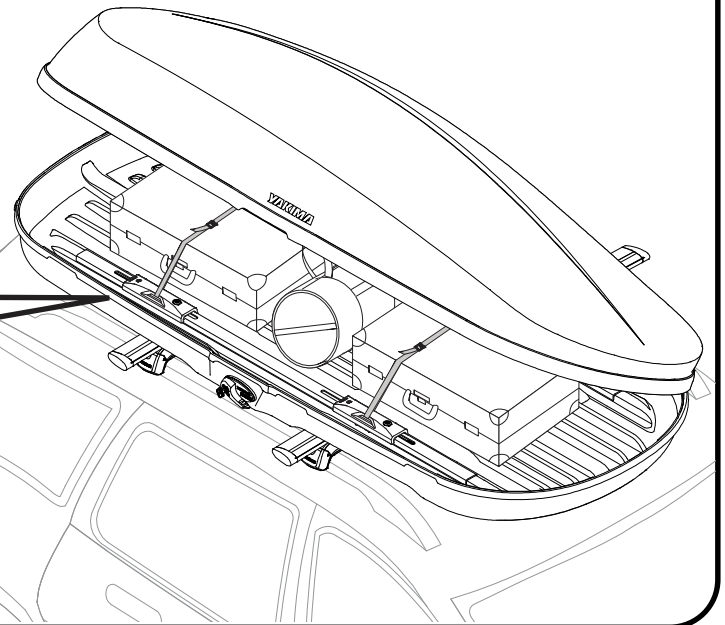
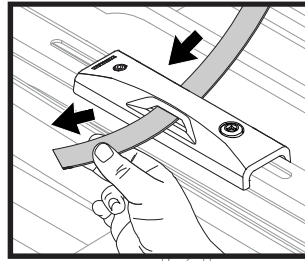
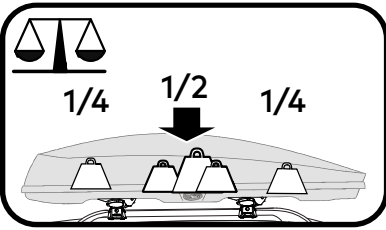

REMOVAL

1 LOOSEN THE CLAMPS.

Note: This bolt is not related to installation.

First, unlock and unload the box. Then use the included wrench to loosen the clamps. Stop when the the clamp nut raises slightly and the clamp is fully open as shown. Do not remove the clamp nut.

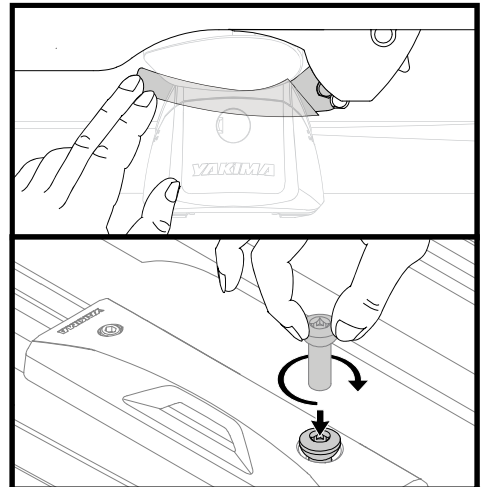
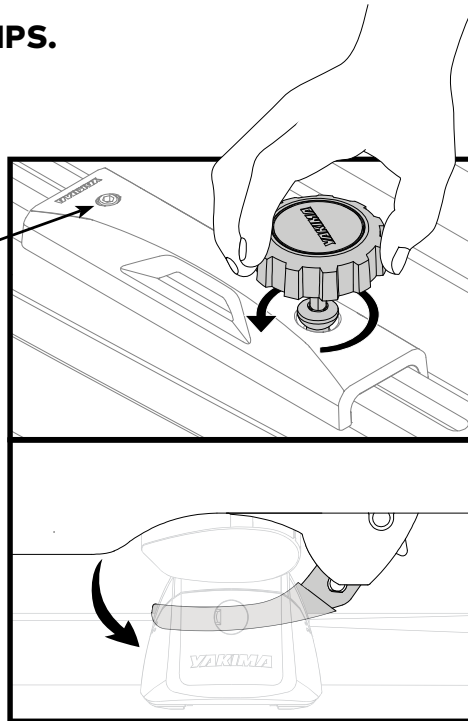

Note: If you accidentally remove the clamp nut, compress the clamp and thread the nut back onto the threaded post.

4X

2 REMOVE THE BOX.

With help from a friend, carefully remove the box from your vehicle.

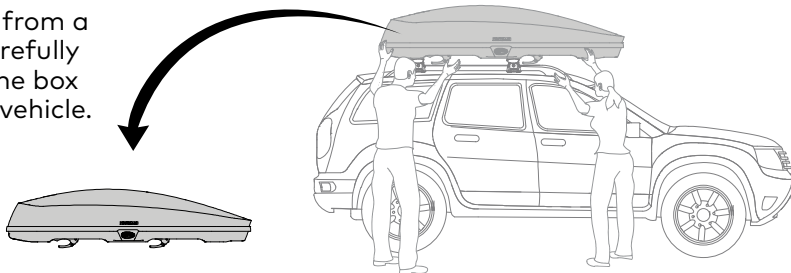

Store the box inside on a flat surface or hang the box by the clamps. Do not store the box by leaning it against a wall.

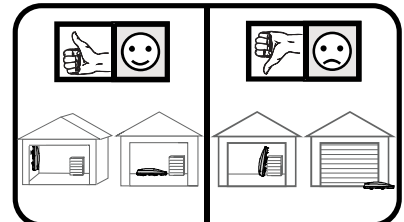



It is important to note the height of your vehicle with the GrandTour installed. Record the height here and be aware of this limitation when passing under low overhead clearance situations such as parking garages. Do not enter if your vehicle's total height is taller than the height listed.

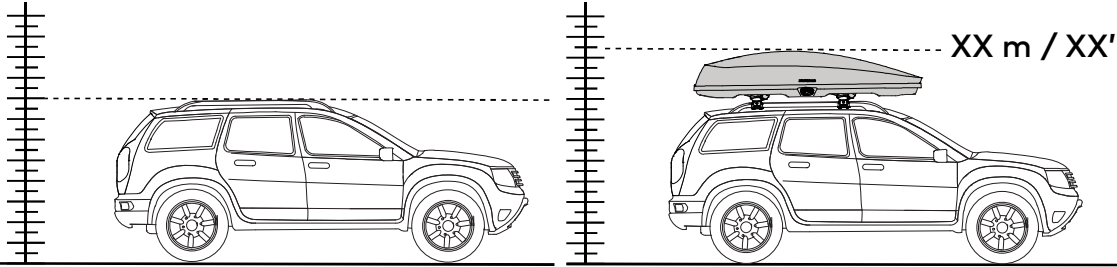

Record Height

Hauteur avec la caisse
Registro de altura



IMPORTANT!

Be sure to read all the warnings and warranty information contained in the insert accompanying these instructions!

READ THESE WARNINGS!

- Attachment hardware can loosen over time. Check and tighten if necessary, before each use.
- Be sure all hardware is secured according to instructions. Failure to perform safety checks before driving away can result in property damage, personal injury, or death.

CARE AND MAINTENANCE

YAKIMA cargo boxes should be cared for and maintained.

- To clean, use only mild detergents. Harsh detergents could damage the cargo box surface.
- Protect your cargo box from extreme temperatures, (heat or cold) during prolonged storage.
- Remove cargo box before entering an automatic car wash.
- Hardware such as locks should be lubricated with graphite or other dry-lubricants.

TIP: Use a hair dryer to warm up the point of purchase sticker and remove it. Dispose of the sticker.

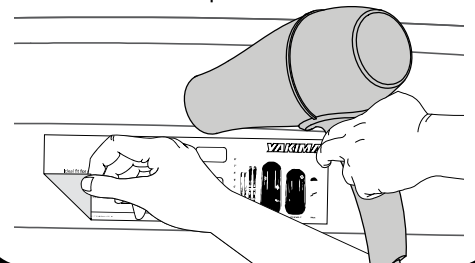

TO REPLACE SKS LOCK CORE

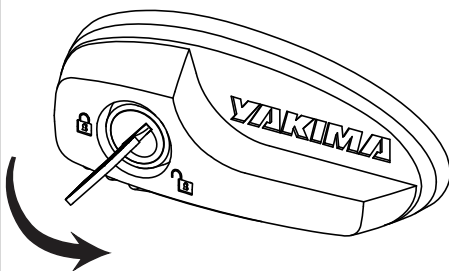

- Close the box.
- Insert key, turn it 45° counter-clockwise, then remove the key.

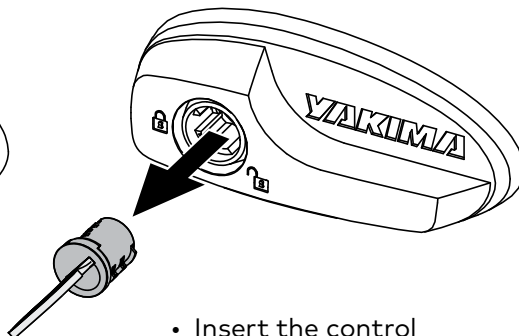

- Insert the control key and remove the core along with the control key.

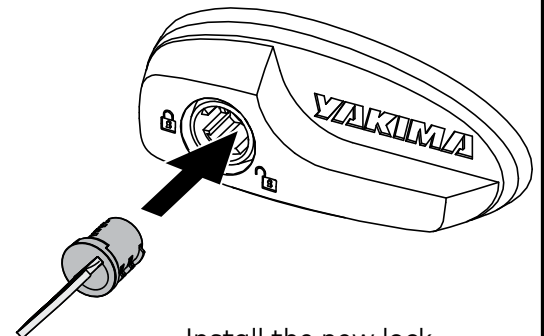

- Install the new lock core. Follow the instructions that came with your lock core purchase.

AVAILABLE ACCESSORIES: Yakima SKS™ Lock Cores with Keys. SKS stands for Same Key System™. These lock cores enable you to lock all of your Yakima products with just one key.

2-Pack SKS™ Locks
#8007202

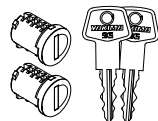

4-Pack SKS™ Locks
#8007204

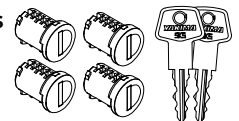

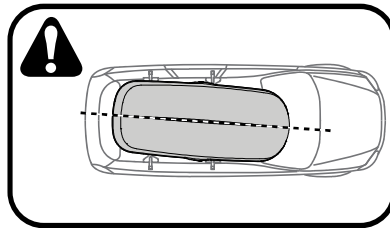
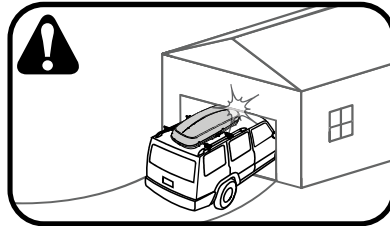
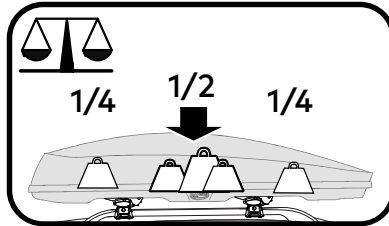
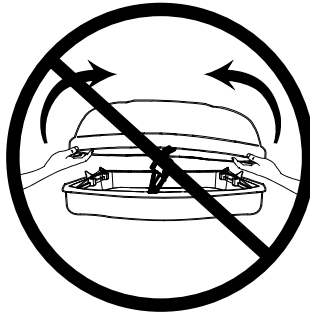
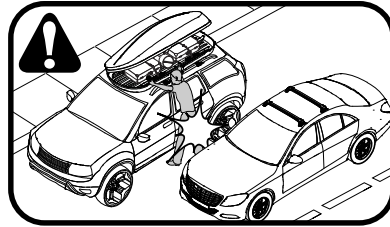
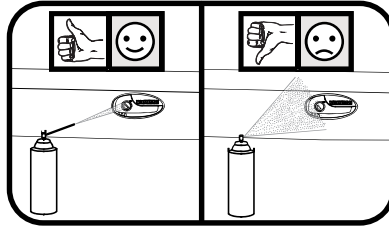
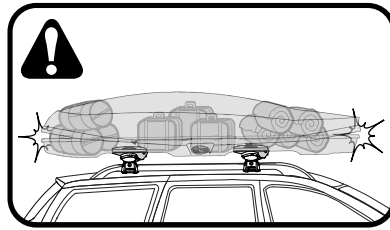
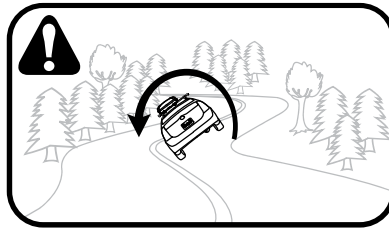
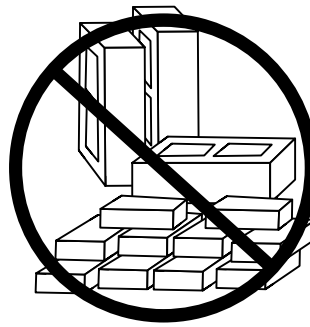
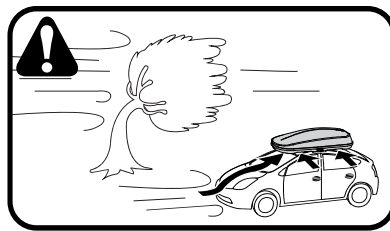
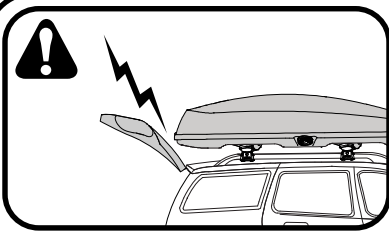

IMPORTANT WARNINGS

Rack Installation

Inadequately secured loads and incorrectly mounted roof racks and accessory racks can come loose during travel and cause serious accidents! Therefore, installation, handling and use must be carried out in accordance with product and vehicle instructions.

In addition to these instructions, review the mounting instructions for the roof rack and the operating instructions of the vehicle.

These instructions should be kept together with the vehicle's operating instructions and carried in the vehicle when in use and en route.

For your own safety, you should only use roof racks that are authorized for use with your vehicle.

For roof racks that do not specify the distance between the front and rear crossbars, the distance shall be at least 700 mm or as large as possible. Please note that changes (e.g. additional drill holes) to the accessory rack's attachment system are not permissible.

Check attachment hardware and load for tight fit and function:

- Before the start of any journey.
- After driving a short distance following rack or load install.
- At regular intervals on longer journeys.
- More frequently on rough terrain.
- After interruption of a journey during which the vehicle was left unsupervised (check for damage due to outside intervention).

Rack Loading

Do not exceed the maximum load specified for the roof rack, accessory rack or the maximum load recommended by the vehicle manufacturer.

Max Roof Load = weight of roof rack + weight of accessory racks + weight of load.

Load shall be uniformly distributed with the lowest possible center of gravity.

Load should not substantially extend beyond the loading surface of the roof rack.

Vehicle Driving and Regulations

The speed driven must be suited to the load transported and to official speed limits. In the absence of any speed limits, we recommend a maximum speed of 80 mph (130 km/h).

When transporting any load, the speed of the vehicle must take into account all conditions such as the state of the road, the surface of the road, traffic conditions, wind, etc. Vehicle handling, cornering, braking and sensitivity to side winds will change with the addition of roof top loads.

If this product is off-road certified, it is designed and intended to be used on forest service roads, access roads or other non-technical terrains at moderate speeds. It is not to be used while rock-crawling, jumping, bogging, or other technical off-road terrains. When using off-road certified products with non-off-road certified products, always follow the warnings and restrictions stated in the non-off-road certified product instructions.

Maintenance

The accessory rack should be carefully cleaned and maintained, particularly during the winter months. Use only a solution of water and standard car wash liquid without any alcohol, bleach or ammonium additives.

For reasons of fuel economy and the safety of other road users, the accessory rack and roof rack should be removed when not in use.

Periodically inspect accessory rack for damage. Replace lost, damaged or worn parts. Use only original spare parts obtained from a stocking specialist, dealer or manufacturer.

Any changes made to the roof racks and accessory racks as well as the use of spare parts or accessories other than those supplied by the manufacturer will lead to the lapsing of the manufacturer's warranty and liability for any material damage or accidents. You should observe these instructions to the letter and only use the original parts supplied.

Record Your Key Number:

(located on the set of locking keys)

--	--	--	--