



Controller

Touch button.

- Tap to switch between onboard presets.
- Hold for 3s to turn off the lights, tap again to turn on.
- Hold for over 6s to reset controller to factory mode.



Download app
"XKchrome"

LED indicator.

- When indicator fades in&out with 50% brightness: It means controller is ON but not connected to any phone.
- When is solid with 100% brightness: It means it's connected to the app.

Multi zone control:

Each controller has multiple output zones. Those zones can be controlled independently via the app. And multiple controllers can be connected to the app at the same time.

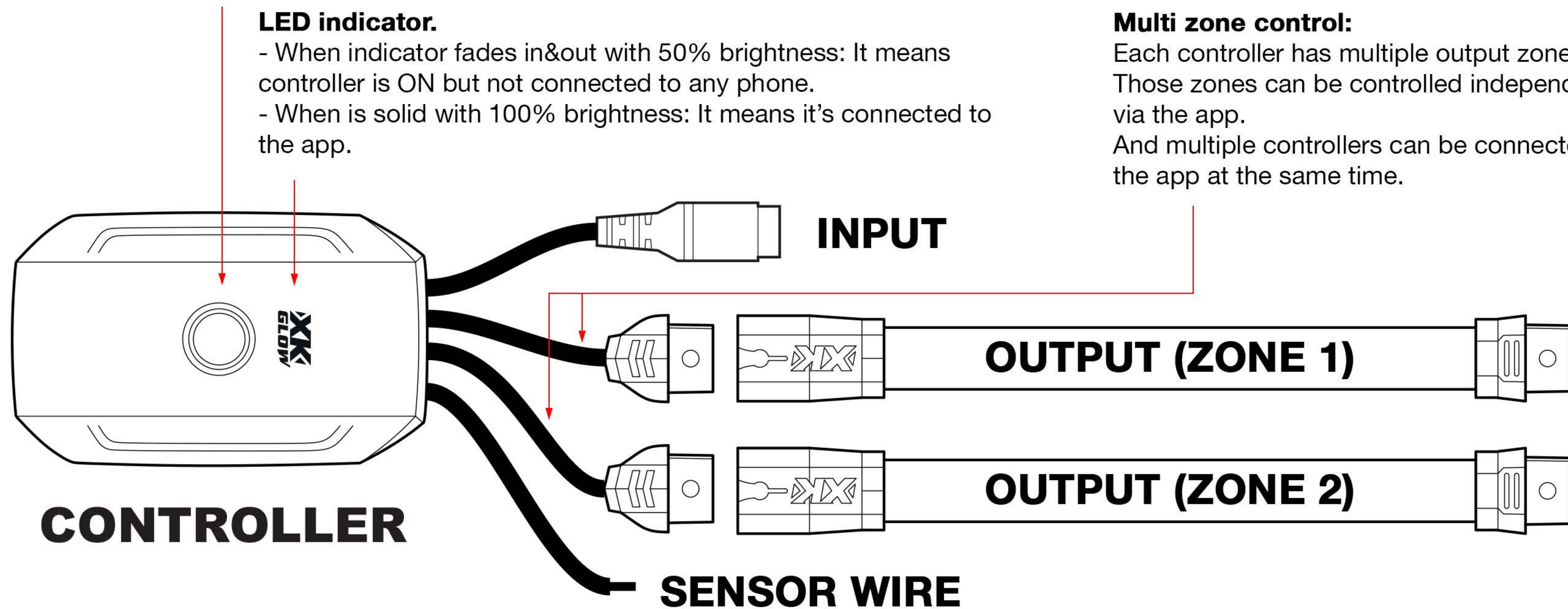

Sensor Wire:

- It's usually connected to certain wire in the vehicle, such as brake wire, turn signal wire and etc.
- It's an optional function. user can choose not to use it.
- When the sensor senses attached wire is getting power, it triggers the controller. User can define what action will the lights do (Such as turn to certain color, or strobe and etc) when this wire is triggered.



Device Setting

How to pair the controller

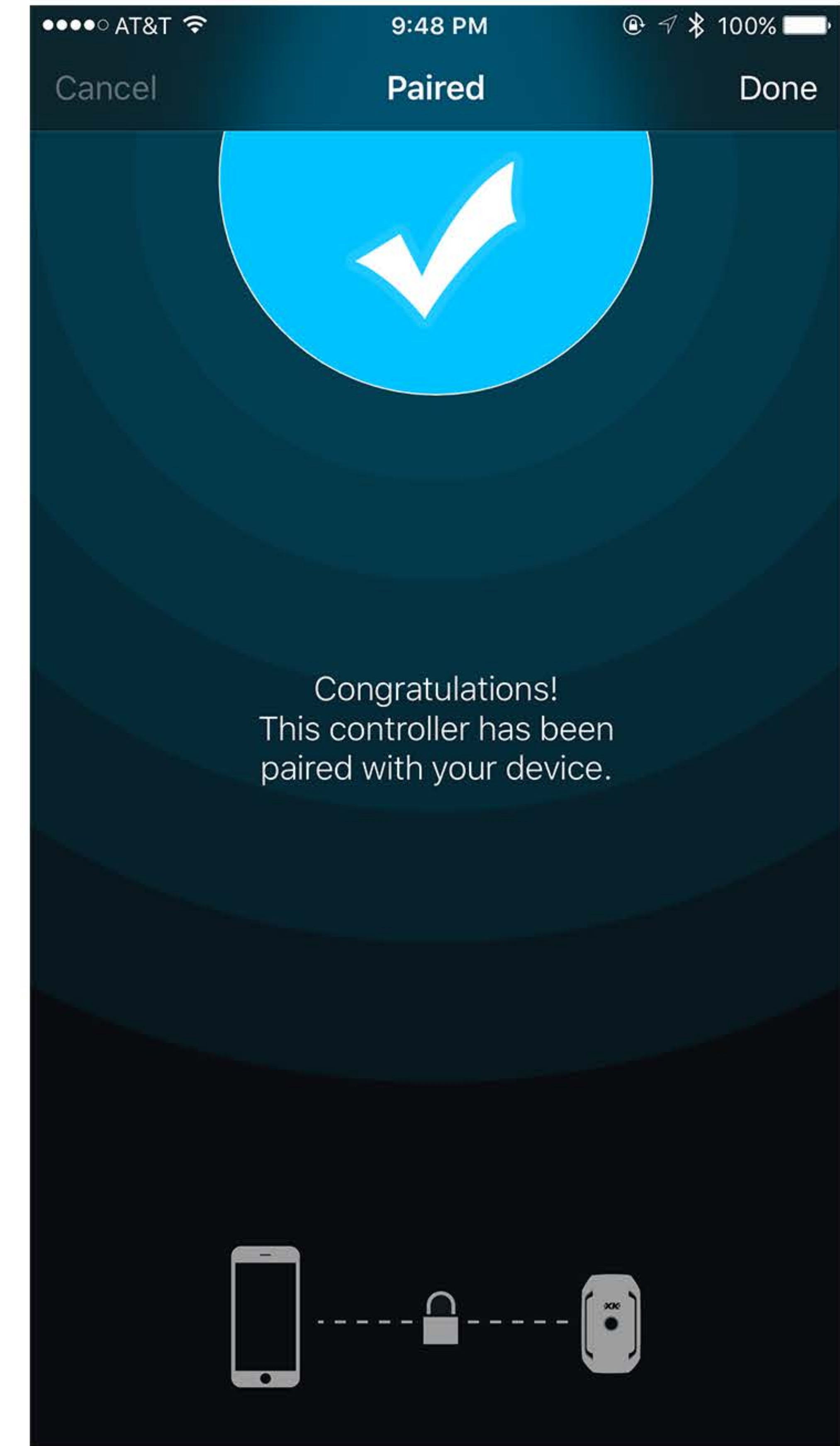
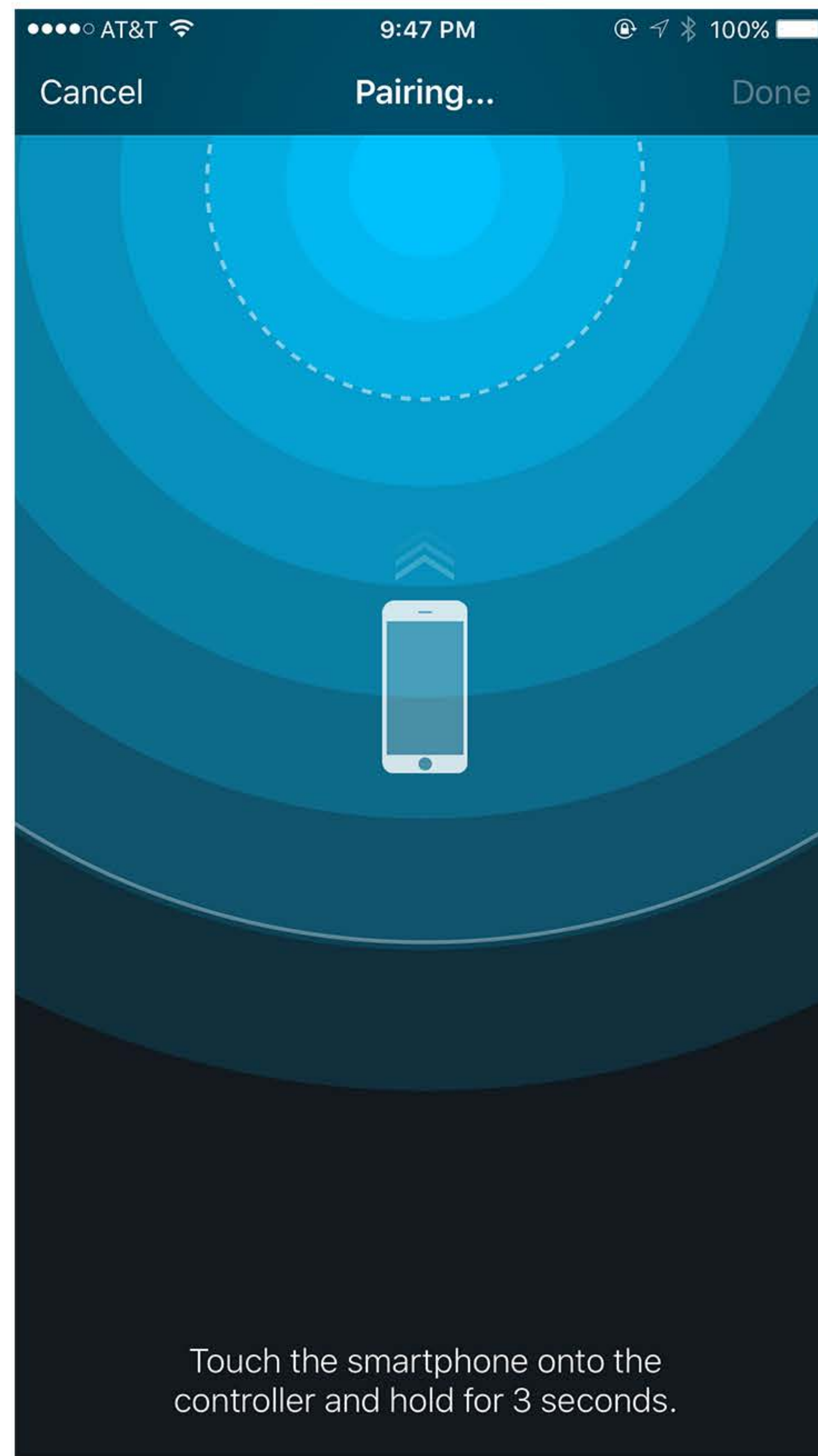
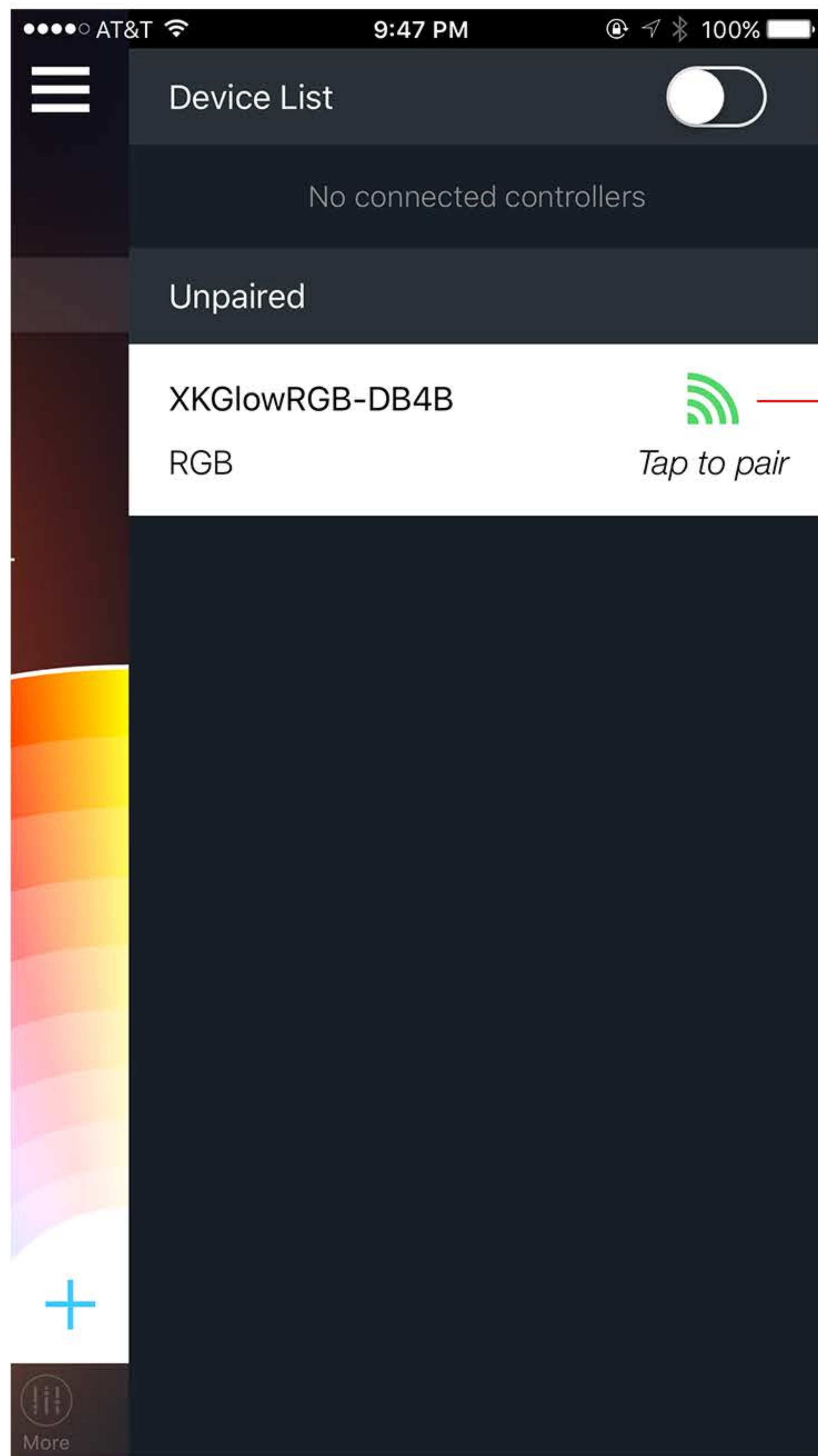

Once the controller is paired, it will appear on the top of device list

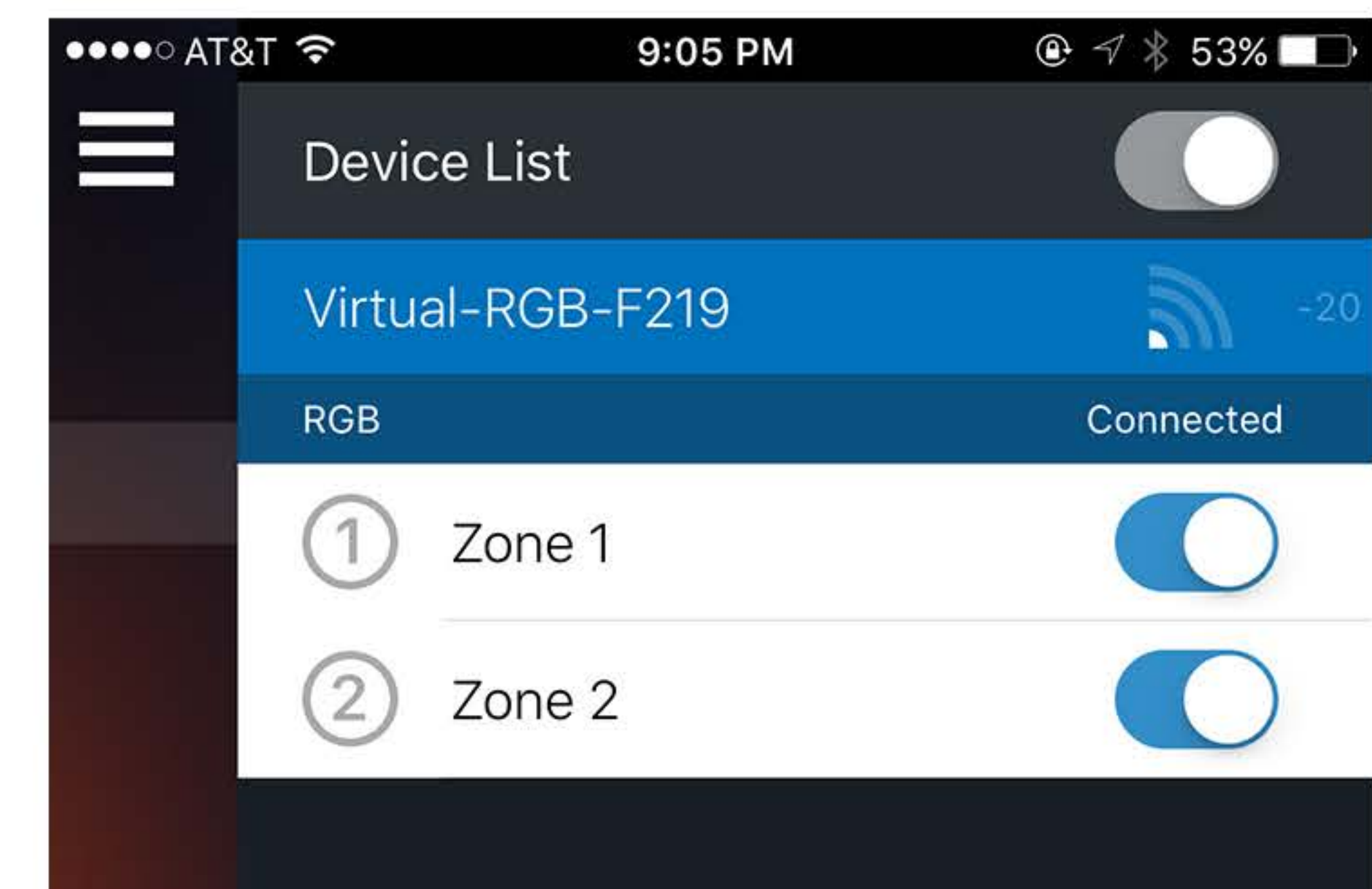



Palette

This page is used to to select a color and apply it to each zone. In addition, user can change a few settings associate with the color.

2- Group

To control multiple zones at the same time, drag one zone towards the other zone (or an existed zone). The group is presented with a double-circle round marker as shown.



3- Ungroup

Tap the group marker to expand all zones in that group, drag a zone marker out of the group.

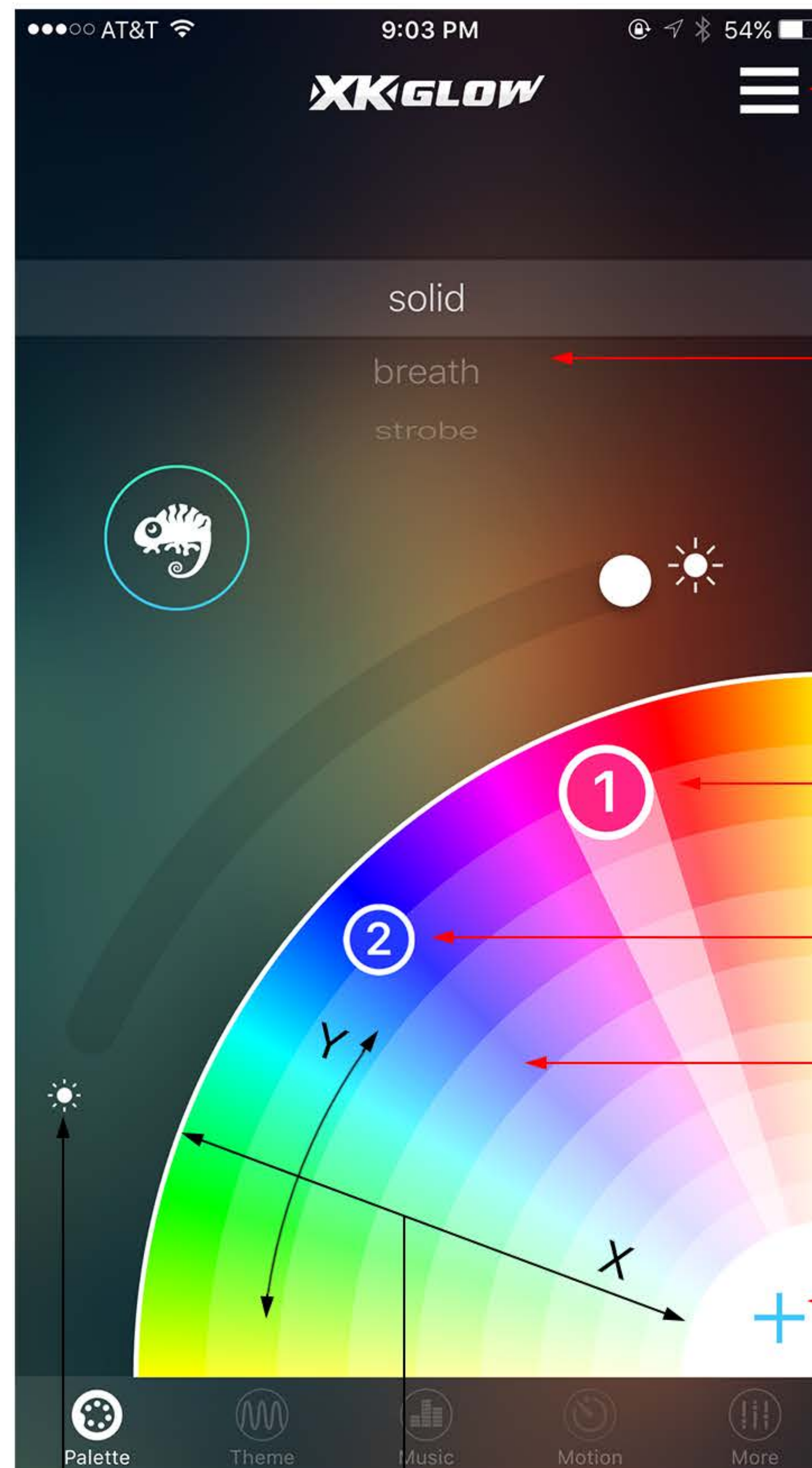

Device setting: Pair/unpair controllers; Edit settings of each paired controller

A scroller that includes three most commonly used patterns: solid, breath(fade in/out), and strobe. The selected pattern will be applied to current zone.

1- Multi zone control

Each controller contains multiple zones. Each zone is represented with a round marker with number inside.

The currently selected zone marker is slightly bigger. To change colors, drag the marker on palette.

Unselected zone is slightly smaller.

This 1/4 circle palette contains all available colors.

Click "+" to other supporting functions for Palette page.

In this app, colors are defined using HSV method:

- **H: Hue.** As shown in Y axis direction.

- **S: Saturation.** As shown in X asix direction. The closer to the cernter, the "whiter" it gets, until it bcomes pure white when marker is touching the central ring.

- **V: Value.** (Brightness) The brightness is adjusted by this arc-shaped scrolling bar.

XK GLOW

Palette

Present selected zone

If the environment is too dark, app will automatically turn on the flash light.



Click "Chameleon" button to activate camera to capture color from real world.

The captured and processed color is displayed at the bottom bar in realtime.

The color within the central circle will be captured.

If user likes the captured color, tap the chameleon button. It will go back to the Palette page and the zone marker will move to the captured color. This color will stay on the selected zone.

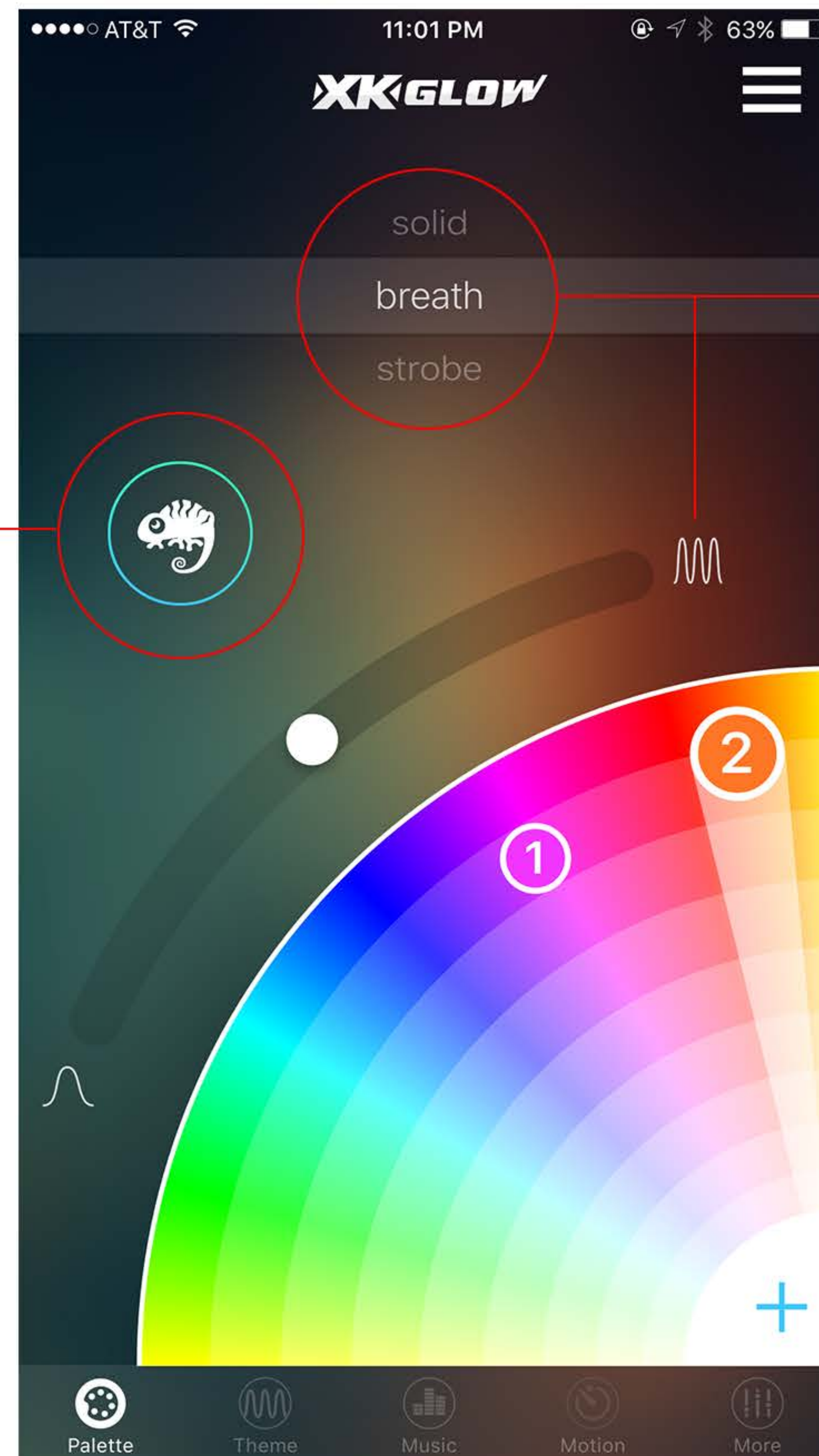

If the pattern is **solid**, the slide bar is used for adjusting brightness.

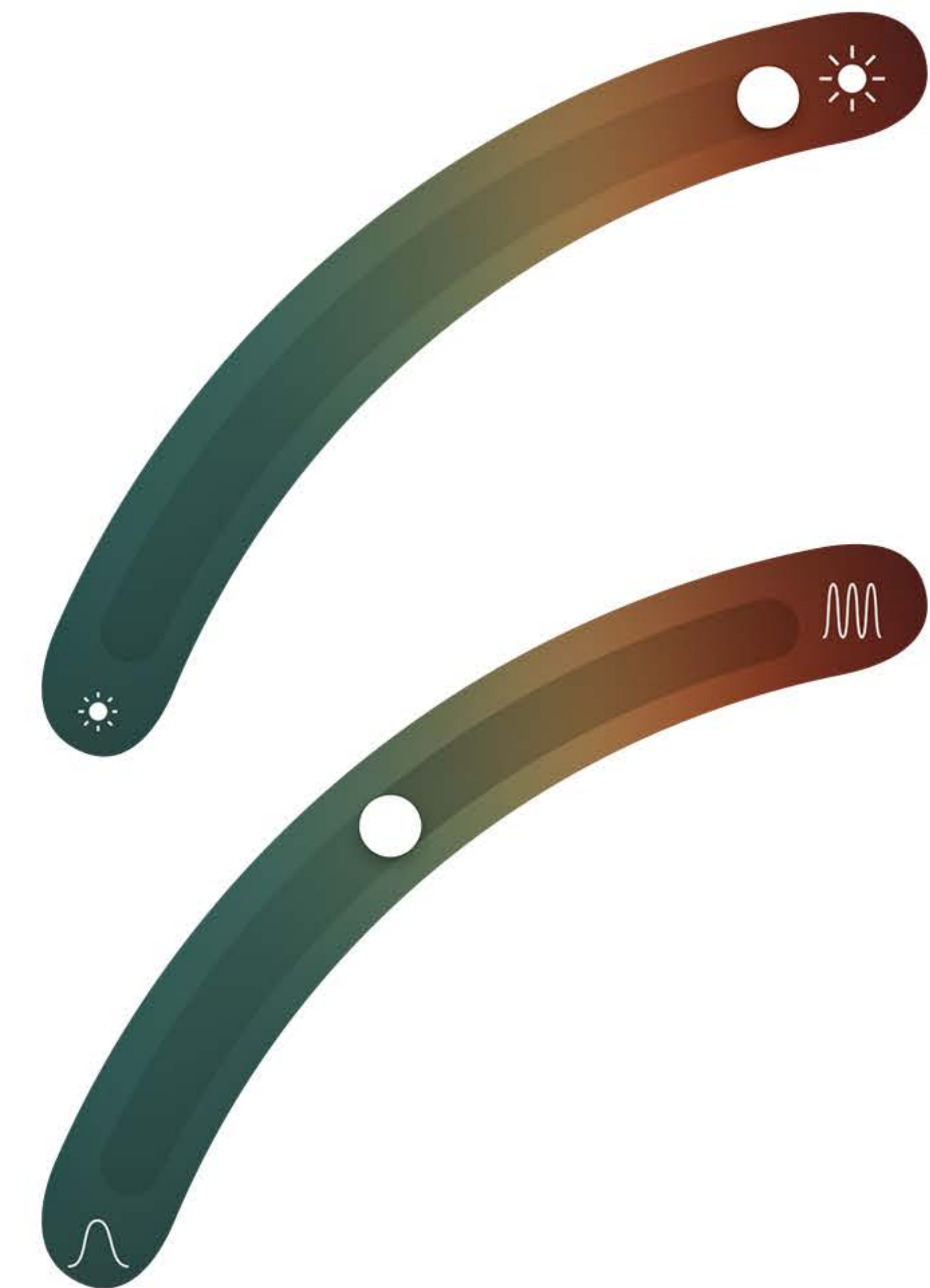

If the pattern is **breath or strobe**, the slide bar is used for adjusting the pattern changing speed.

As you can see. The interface in this app is designed for single hand use. Most buttons are within the range of the thumb.

In the future we will also design "left hand" mode that mirrored the current "right-handed" design.



Palette



Click the “+” button at the right bottom corner to access the supporting page.

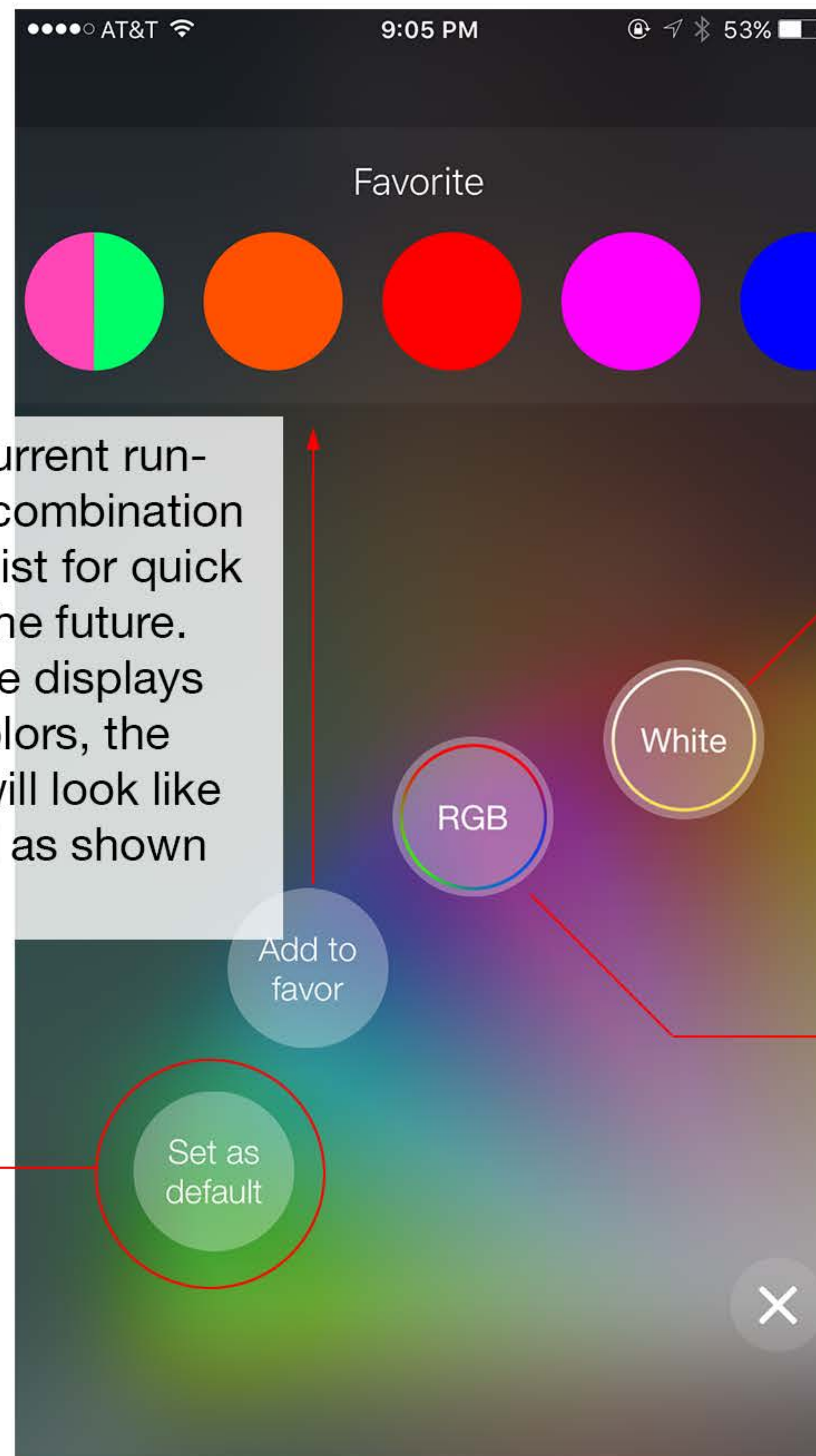

Save the current running color combination to favorite list for quick access in the future. If each zone displays different colors, the color ball will look like the 1st ball as shown above.

Add to favor

Set as default

Click to save the current running theme as the startup default theme when controller is powered on. This allows user to perform certain simple functions without using the app.

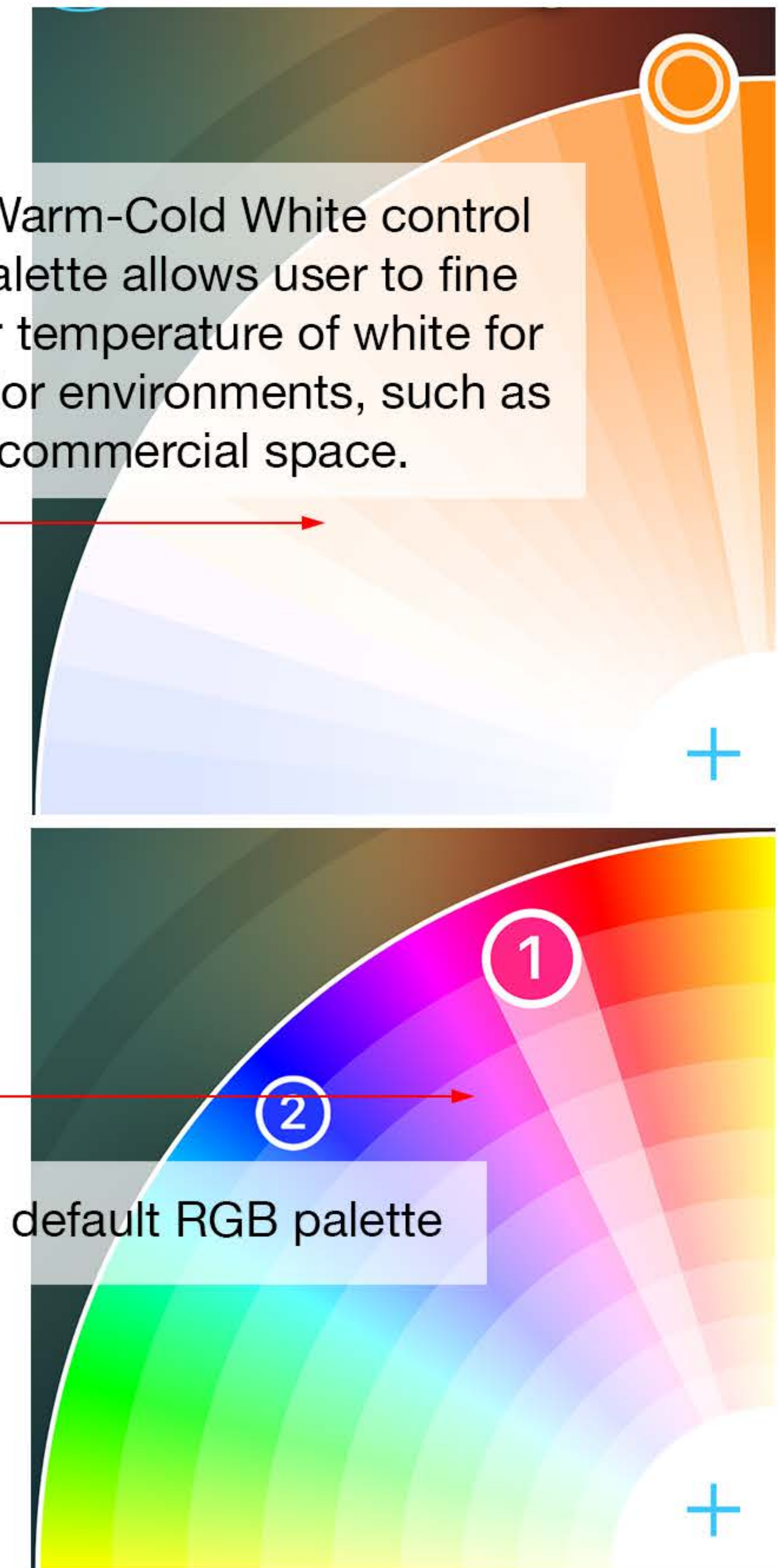

Tap to go to Warm-Cold White control mode. This palette allows user to fine tune the color temperature of white for different interior environments, such as residential or commercial space.

Tap to go to default RGB palette



Theme

Theme page allows user to play more complicated changing patterns. It comes with 15 presets, and allows user to edit them or create new ones.

Create New Theme

The small zone marker indicates what theme is each zone current running.

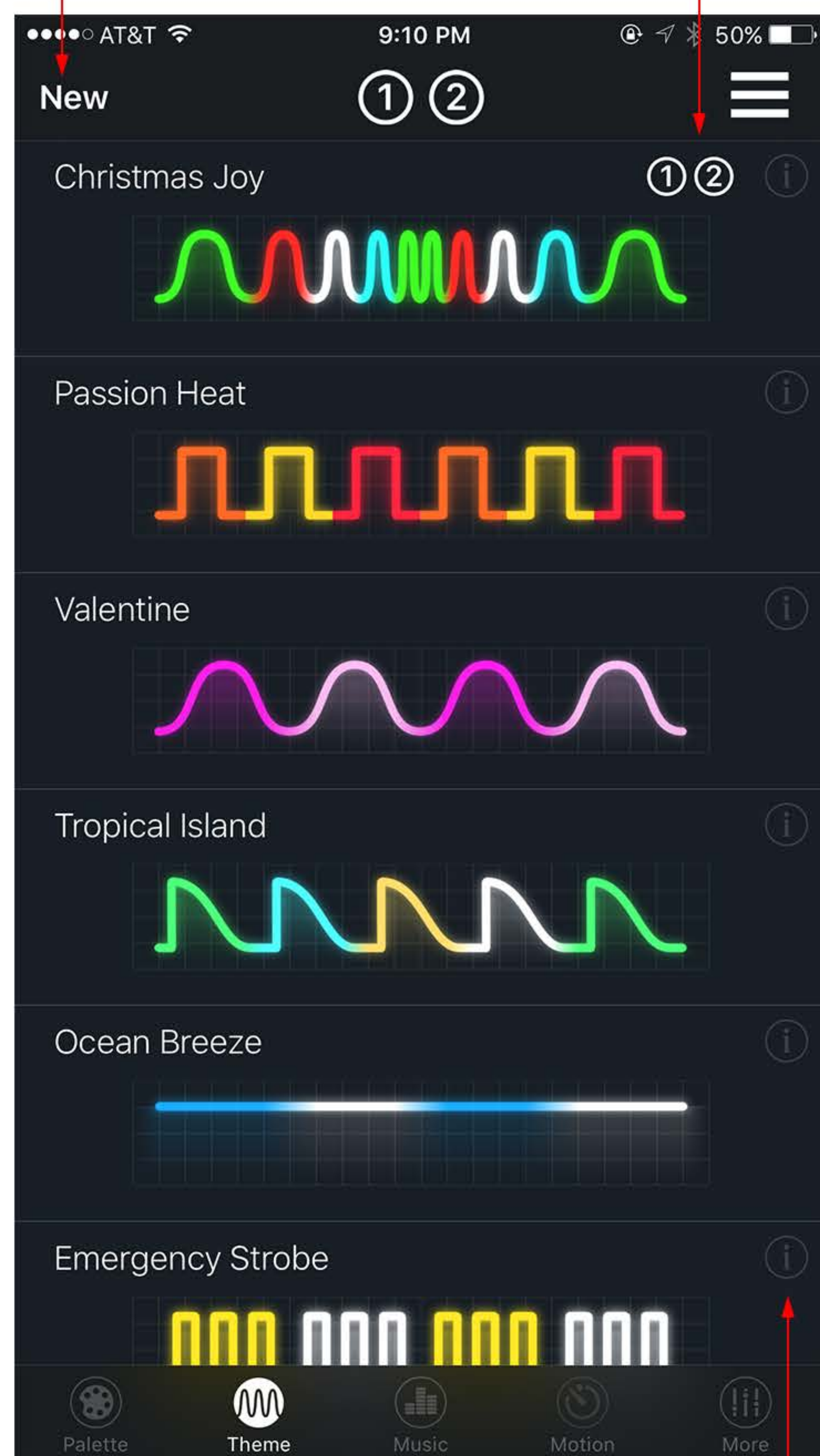

Click to edit existing theme
(As the long screen show on the right)

Each theme is defined by following elements:

1- Name

2- Colors
User can assign up to 10 colors within a group.

3- Pattern

These wave patterns represents how the light changes, the X axis is time, Y axis is brightness of the light.

4- Speed

How fast the pattern changes.

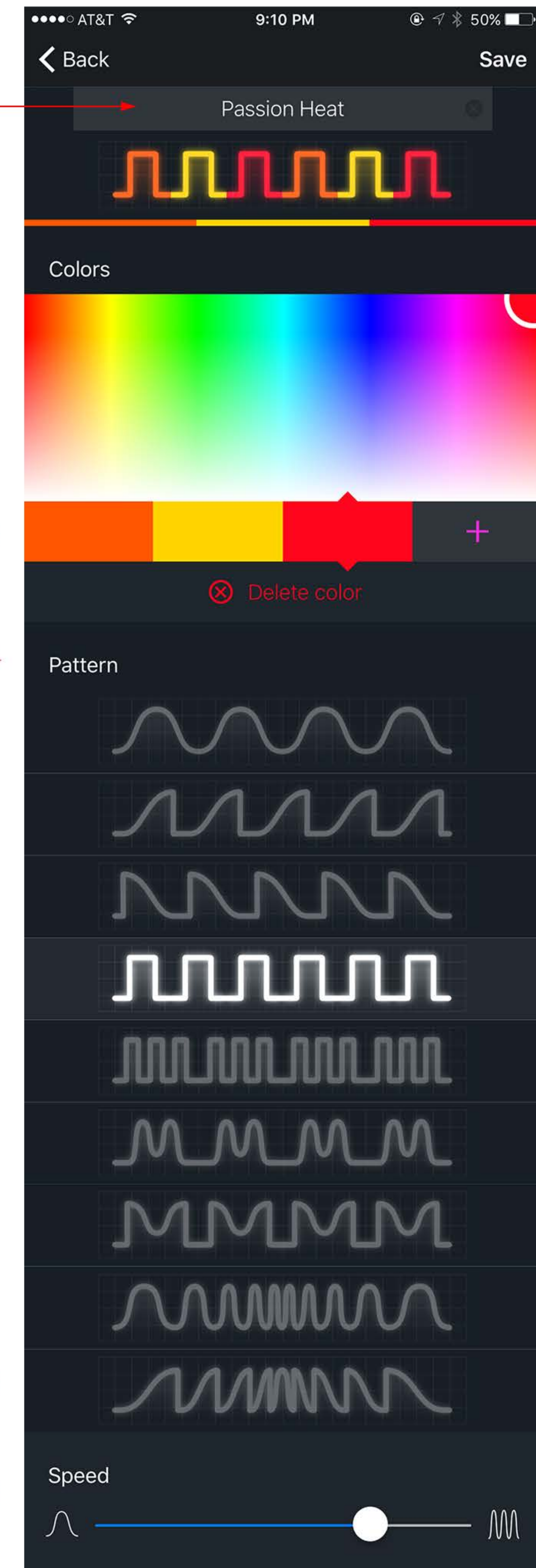

XK GLOW

Theme

Each theme is represented with a diagram.

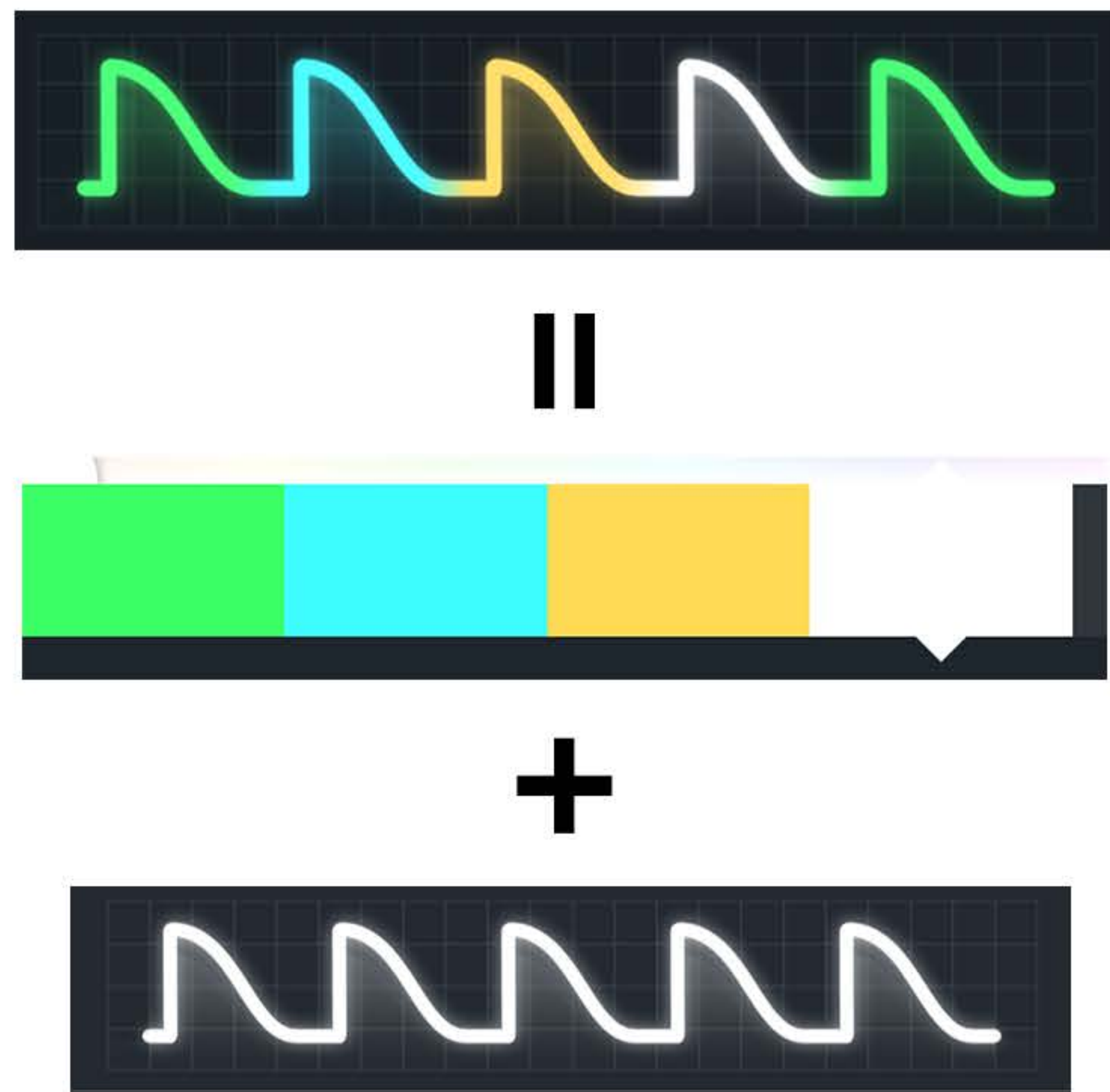

Each zone can display theme different from others.
The top zone markers serve as check-box.
As shown below, click "2" to uncheck zone 2. then click the second theme, now only zone 1 is assigned to the

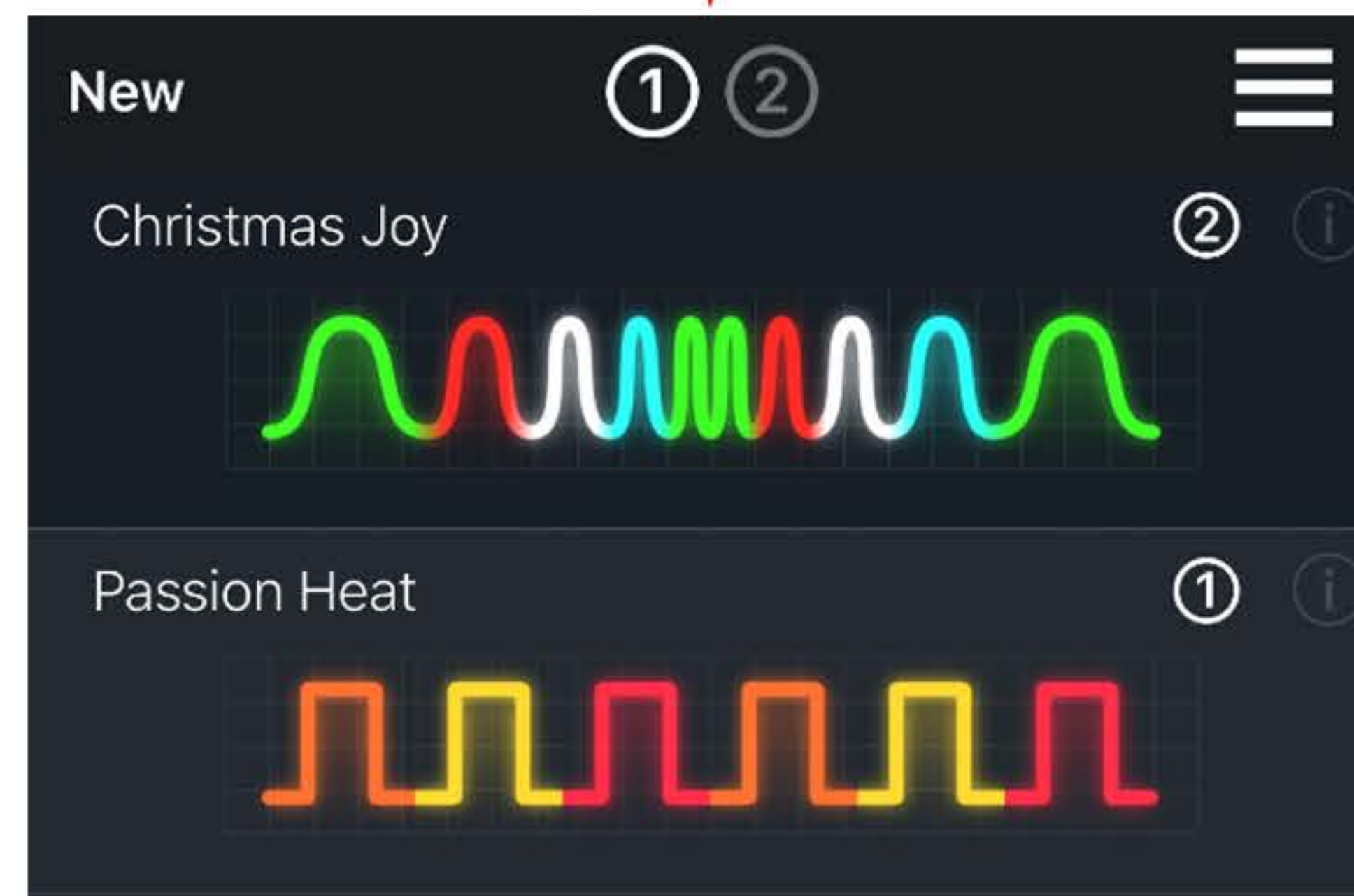

When a theme is being applied to a zone, user can set this theme as Start-up theme and etc to current assigned zone(s), similar as Palette page.

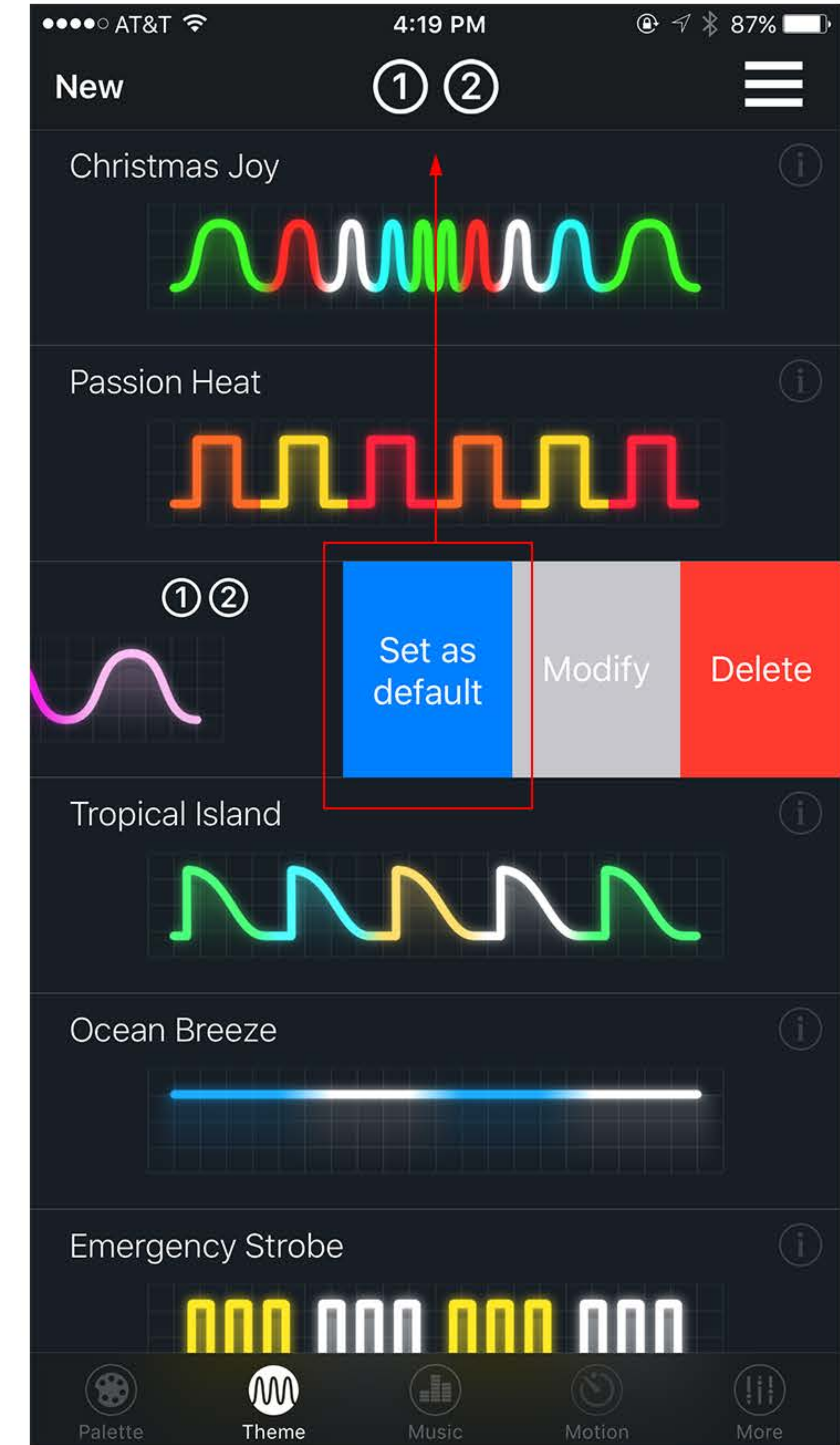



Music

This function controls the light to respond to various sound sources in several ways.

Mic Mode:

Light changes according to sound picked up by mic.

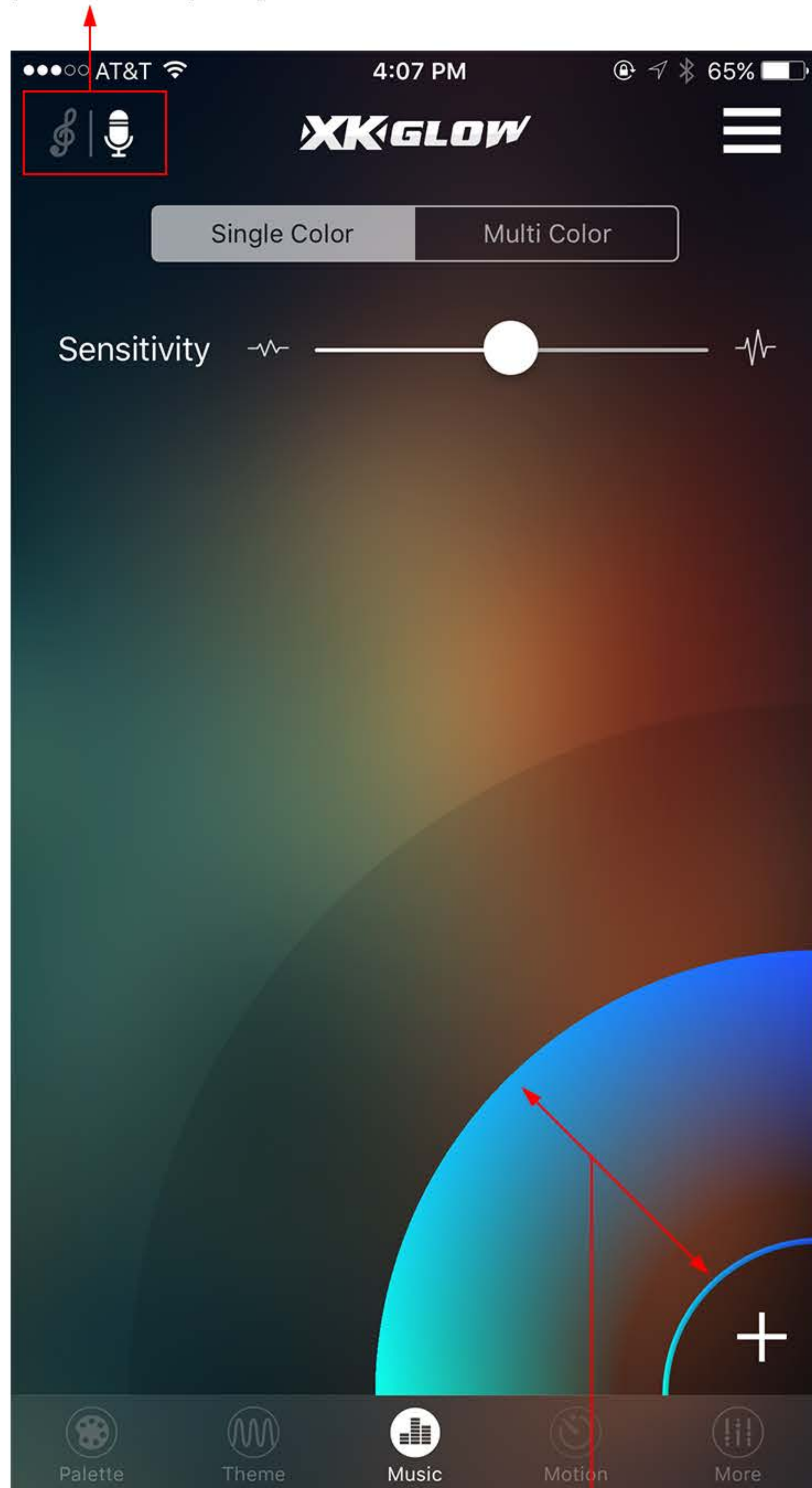

Music Mode:

Light changes according to music downloaded in the app.

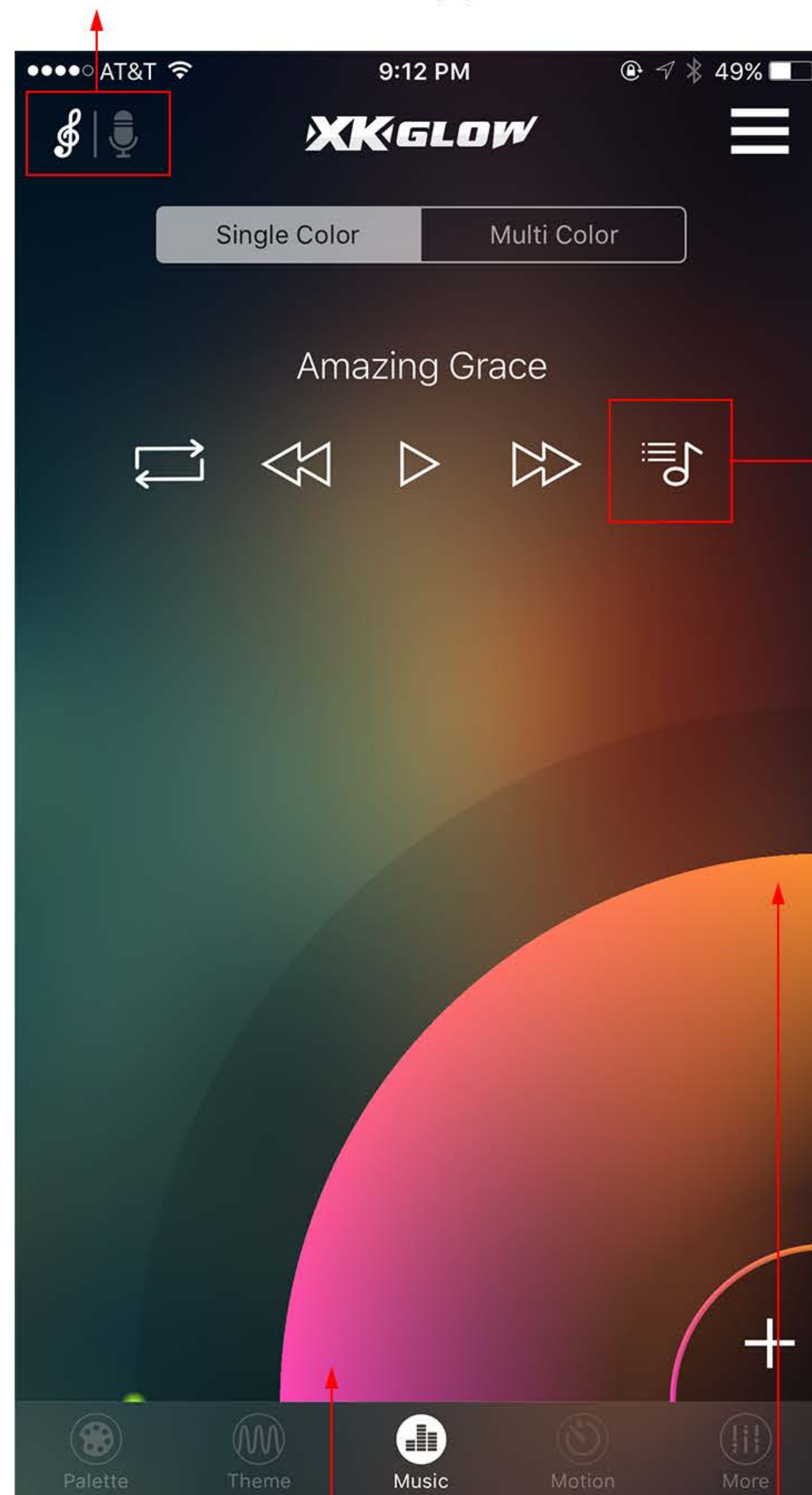

User can add, remove, rearrange songs in the playlist in this page. This is a fully functional music player.

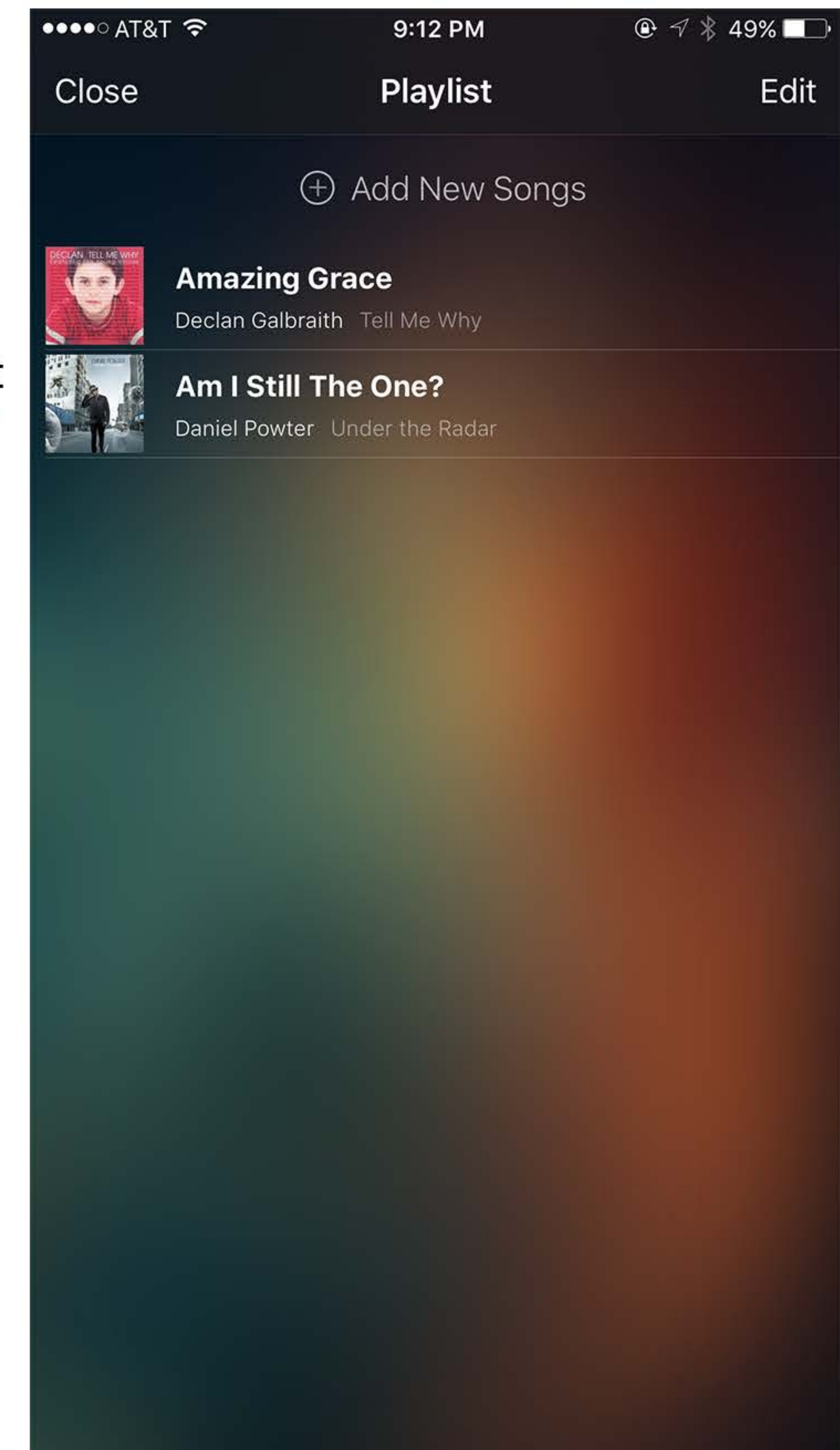

1- The size of the sector will change based on the volume of the music in real time.

2- The color of the sector indicates the current color of each zone. If each zone is displaying different color, they will be blended as shown above.



Music

In **single color mode**, user can only assign 1 color to each zone.
The brightness of that color will be mapped to the volume.

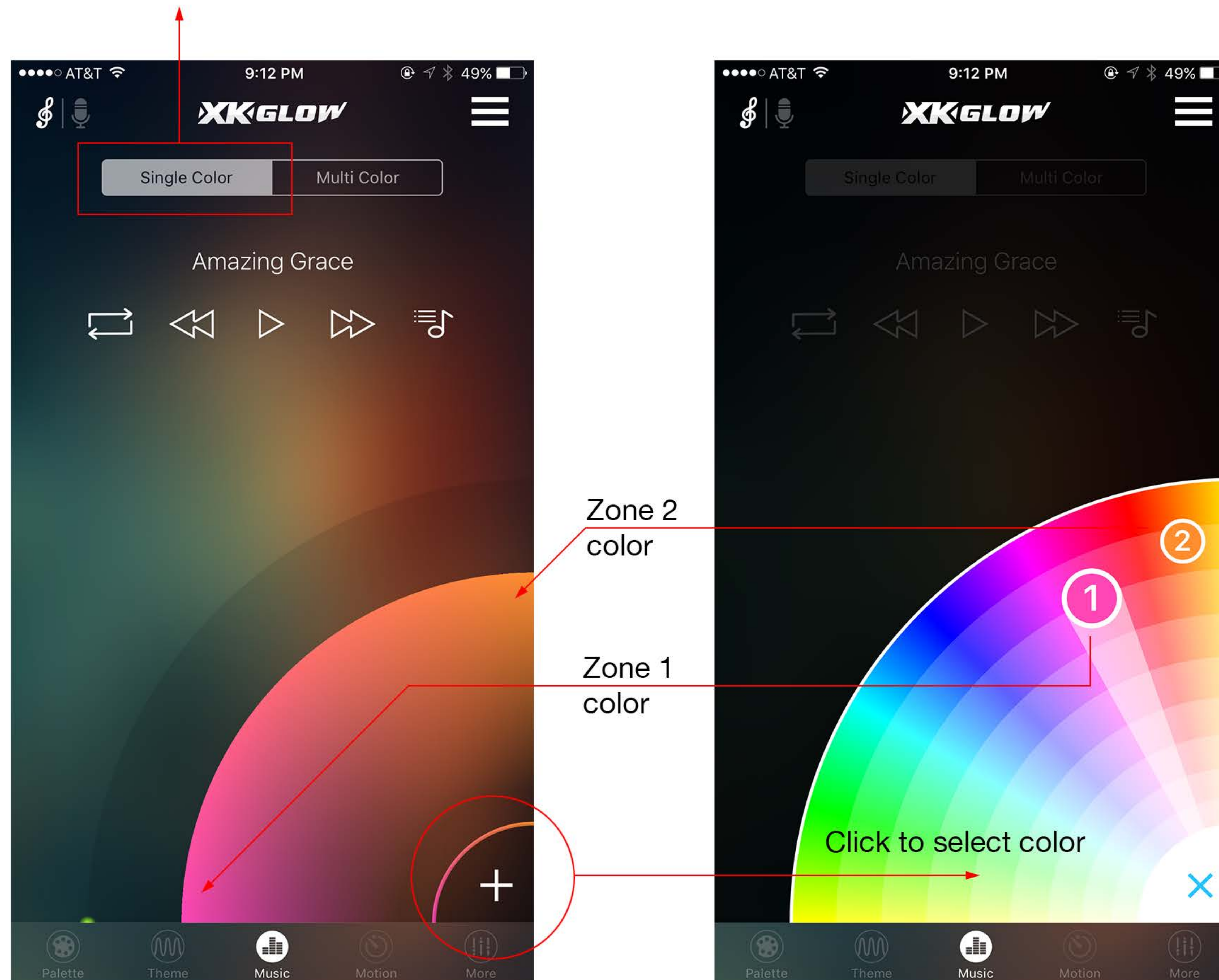

In entire music page (including single/multi color modes, and mic/music modes), we used a dynamic analysis algorithm to analyze the sound/music. Every 5s, the program adjust its color mapping scope based on the volume changing scope of the sound/sound within this 5s. This way, the app automatically adjusted its sensitivity to maximize the visual effect of the music mode.



Music

In multi **color mode**, user can assign a group of colors to both zones. Both zones do the something in this mode.

The colors of that group will be mapped to the volume along with the sequence of the colors in that group.

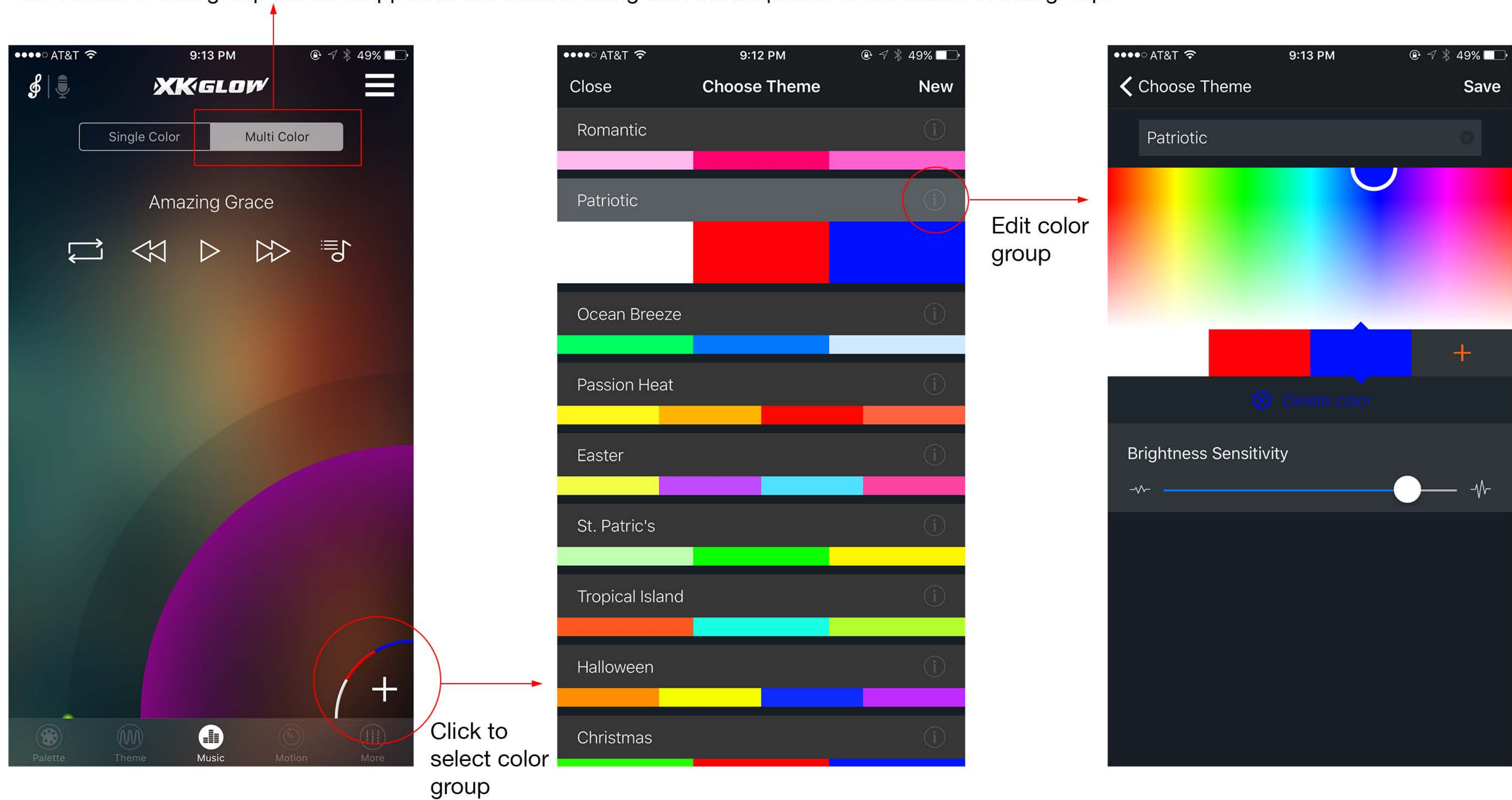



Location

This function helps driver find where their car is parked.

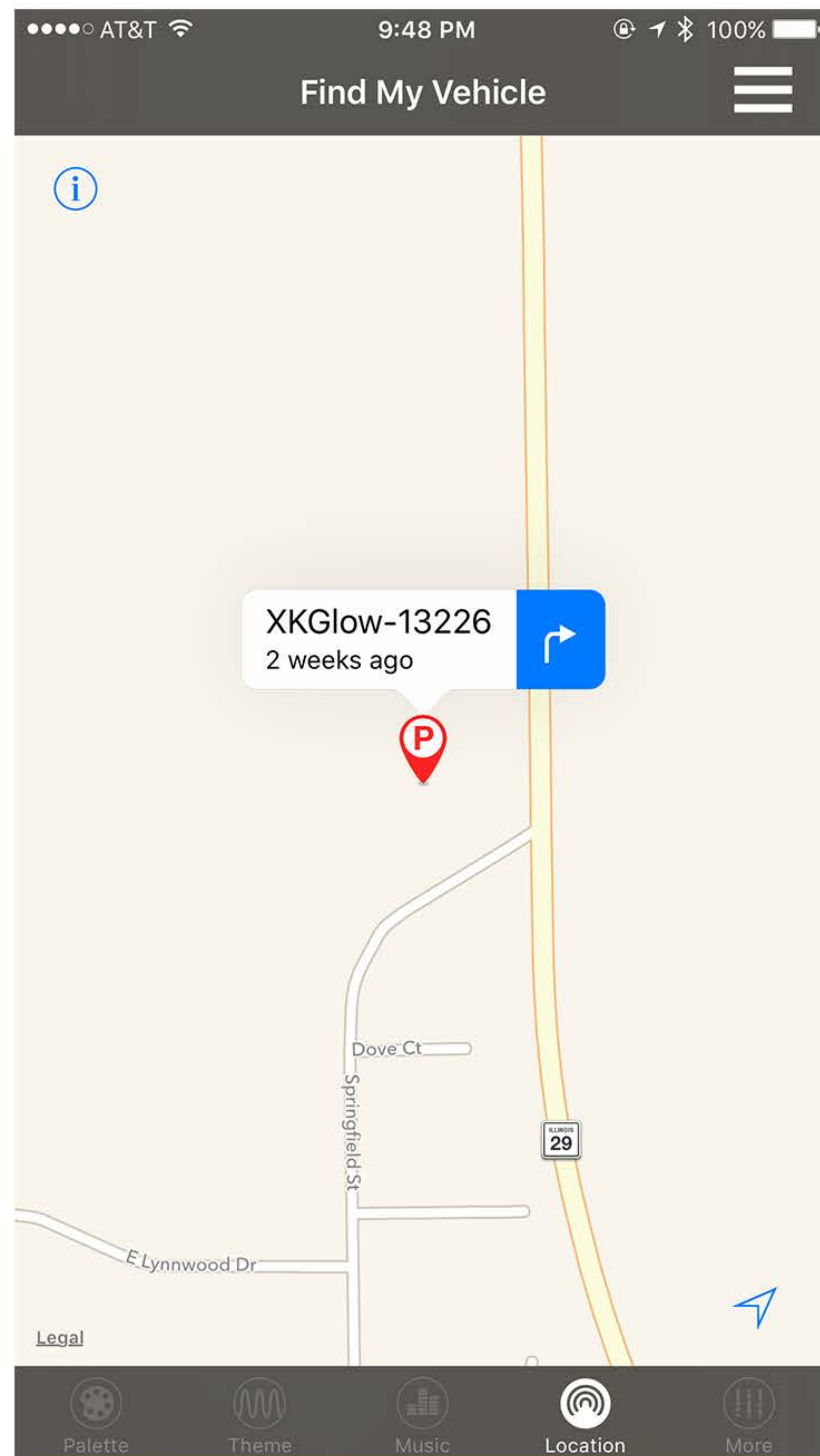

This is the work flow of the **Find My Vehicle** function.

- When user parks the vehicle and leaves their car, as the distance between the phone and controller gets longer, the bluetooth connection eventually gets lost at about 30-80ft.

- When the connection is lost, the app will automatically pin down its GPS location as vehicle's parking location and display it on the map as shown on the left.

- User can click  to use navigation app for directional guidance if needed.

- Once the user walks back to the spot and reconnect to controller, the icon will show as Connected as shown on the right. If user still doesn't see the car, he can tap  to turn on the lights.

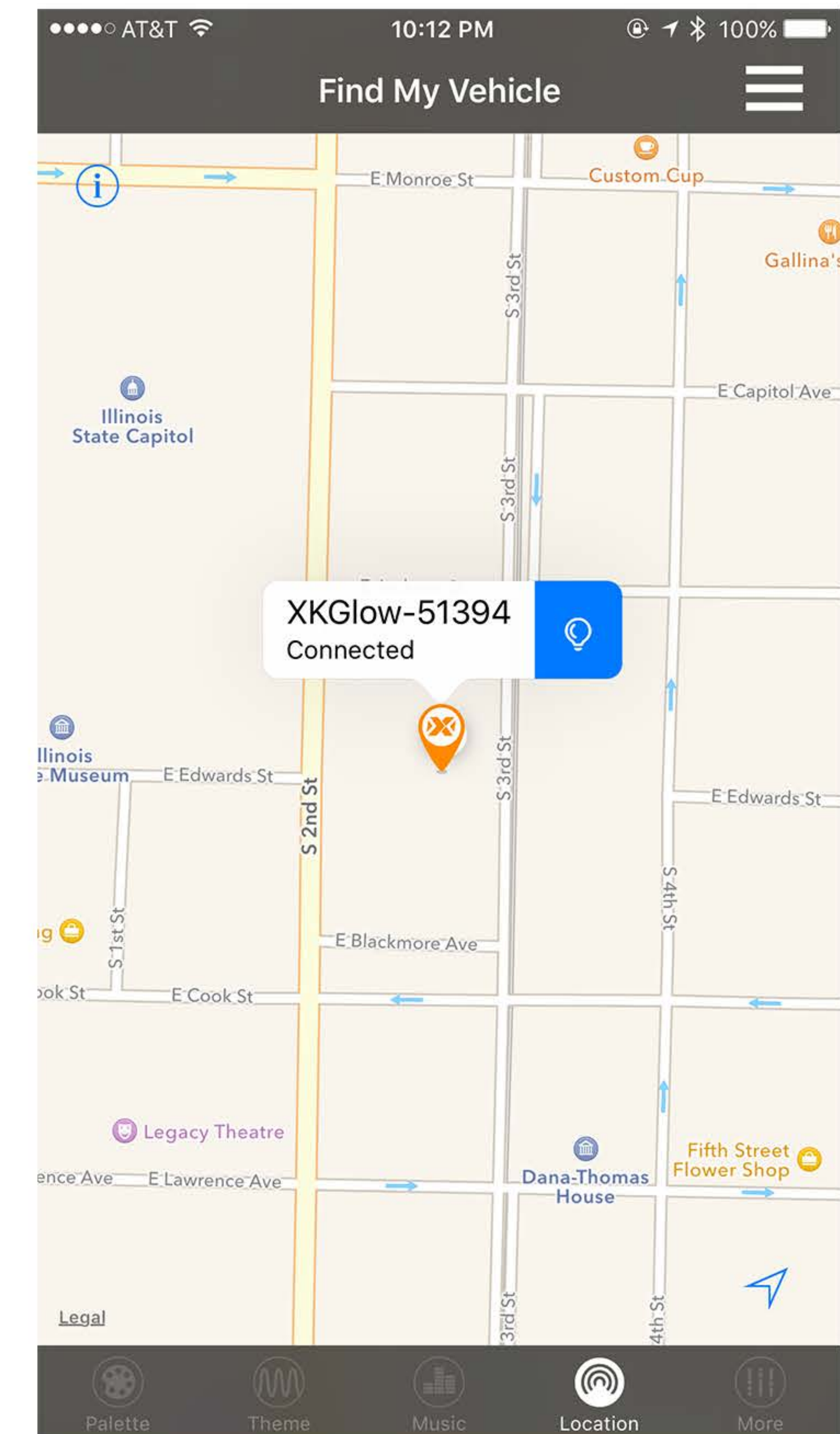



Device Setting

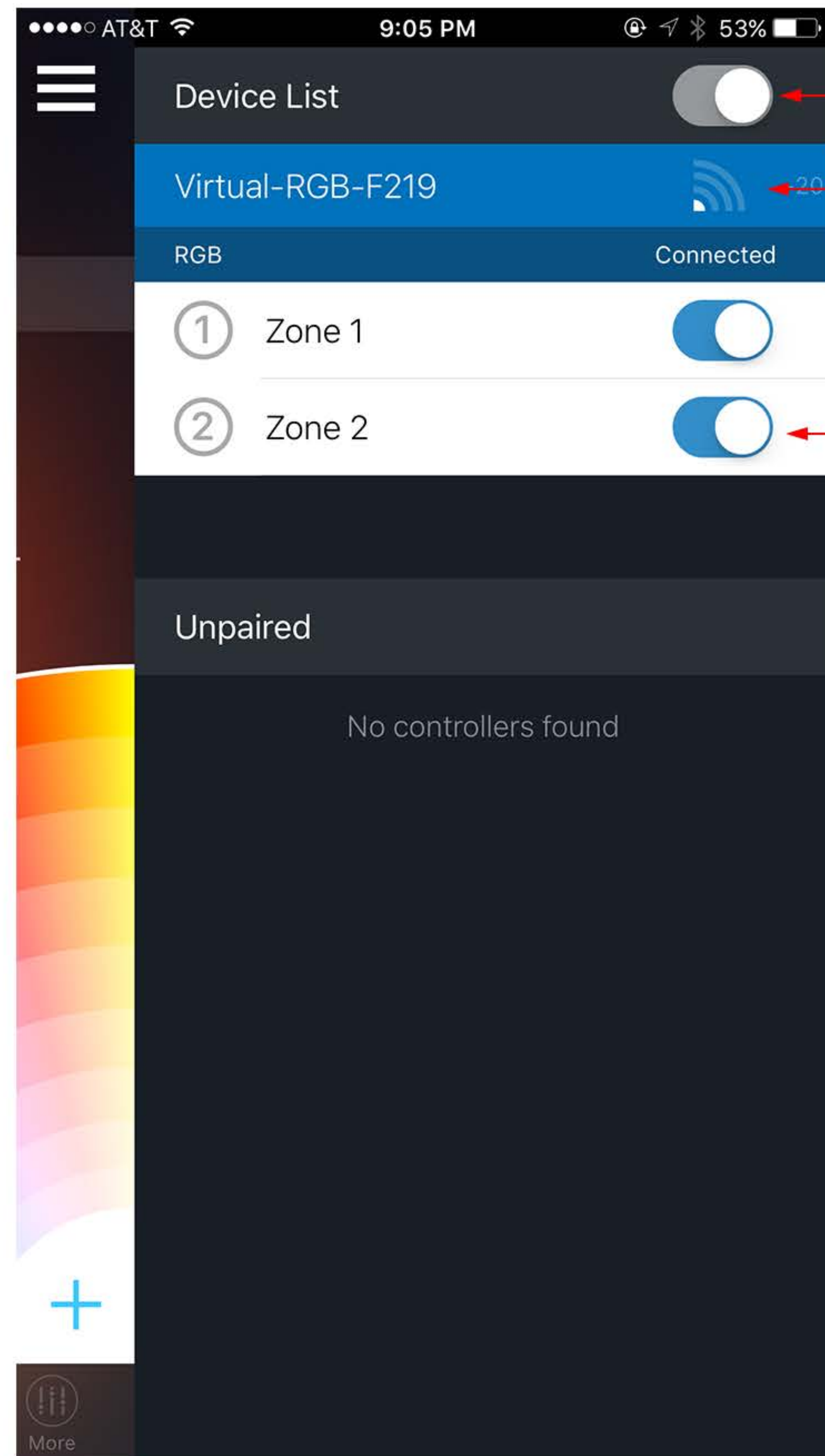

Turn on/off all zones.

Current signal strength.

Turn on/off individual zone.

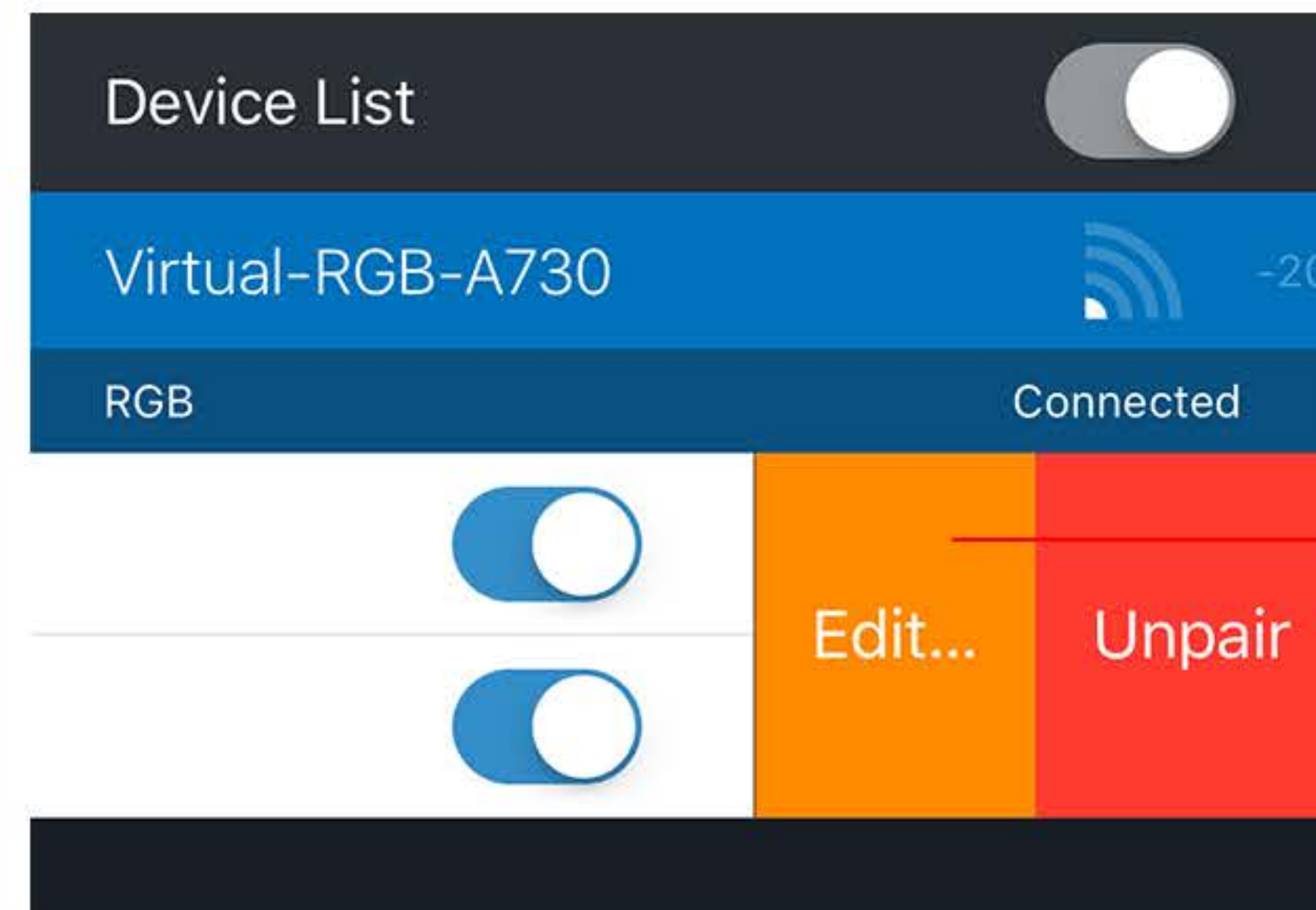

Tap Edit to edit detailed setting of selected controller.

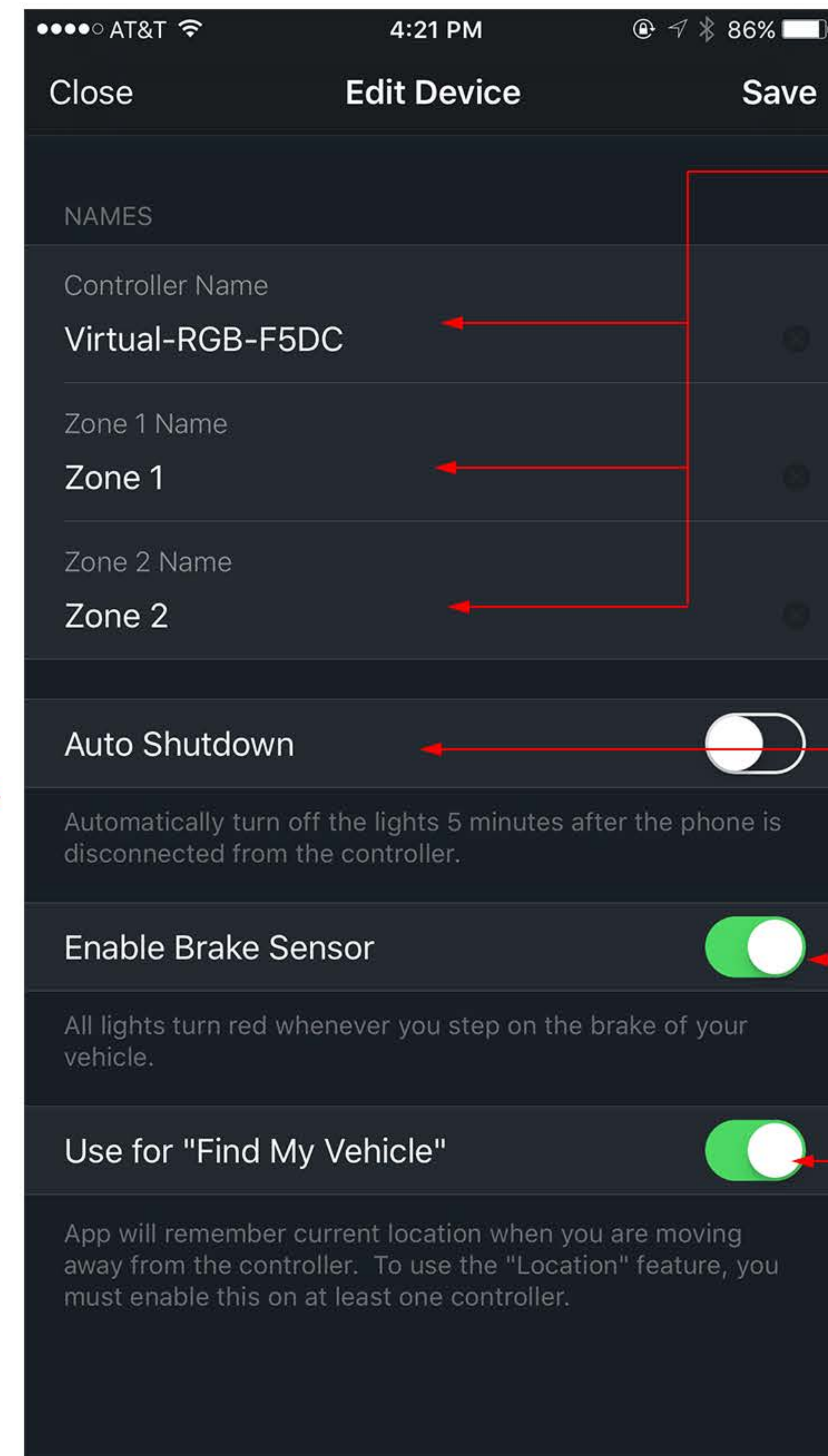

Edit names of the controller or zones.

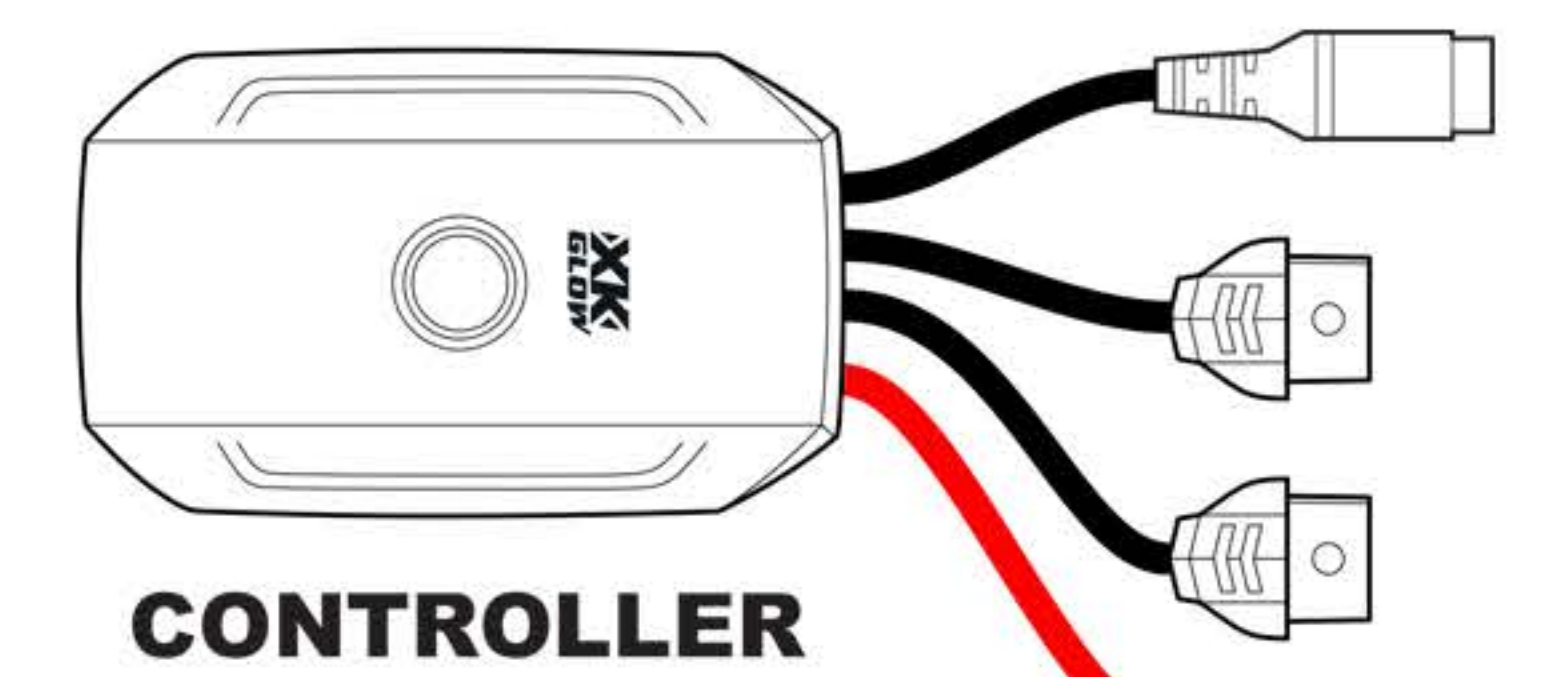

All lights automatically shut off 5min after the connection between app and controller is lost.

If this switch is off, this zone will keep doing whatever it is doing and will not run the SMART SENSOR ACTION.

if turned off, the controller will not be used/triggered by Find My Vehicle function.

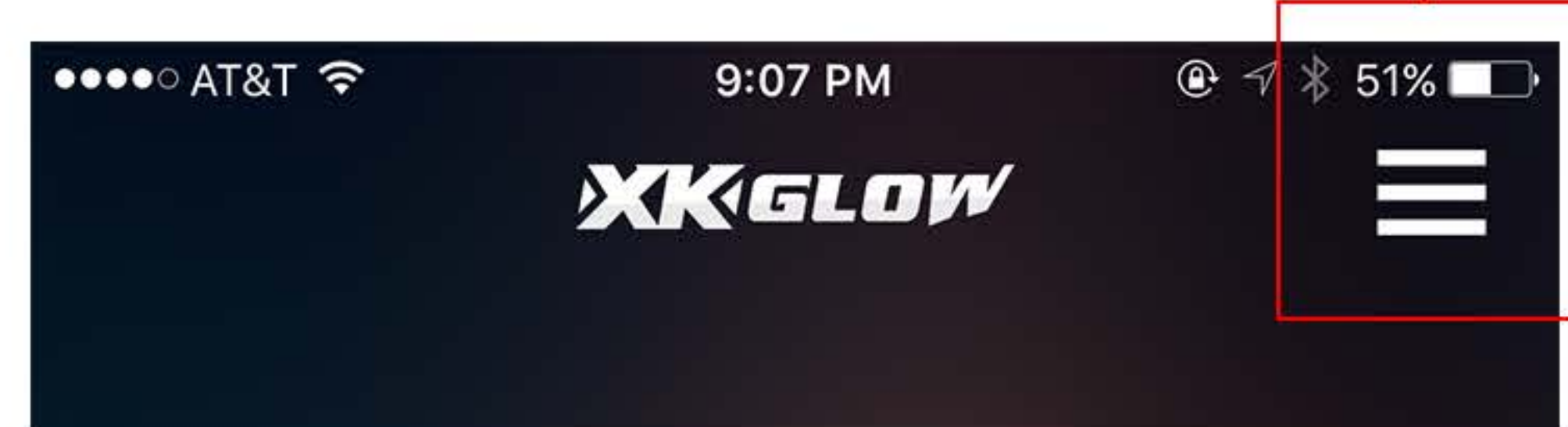

Click  button to open device list. All paired and unpaired controllers that are currently in range are listed here.

Discover various accessory lighting in our online store.