

ASSEMBLY INSTRUCTIONS
FOR
1997 - 2004 CHEVROLET C-5 CORVETTE
2005 - PRESENT CHEVROLET C-6 CORVETTE*

**SUPERLITE 4 REAR BRAKE KIT FOR OE PARKING BRAKE
WITH 12.90" DIAMETER VENTED ROTOR**

BASE PART NUMBER

140-8032

**DISC BRAKES SHOULD ONLY BE INSTALLED BY
SOMEONE EXPERIENCED AND COMPETENT IN THE
INSTALLATION AND MAINTENANCE OF DISC BRAKES**

READ ALL WARNINGS



Photographic Tip

Important and highly recommended: Take photos of brake system before disassembly and during the disassembly process. In the event, trouble-shooting photos can be life savers. Many vehicles have undocumented variations, photos will make it much simpler for Wilwood to assist you if you have a problem.

Exploded Assembly Diagram

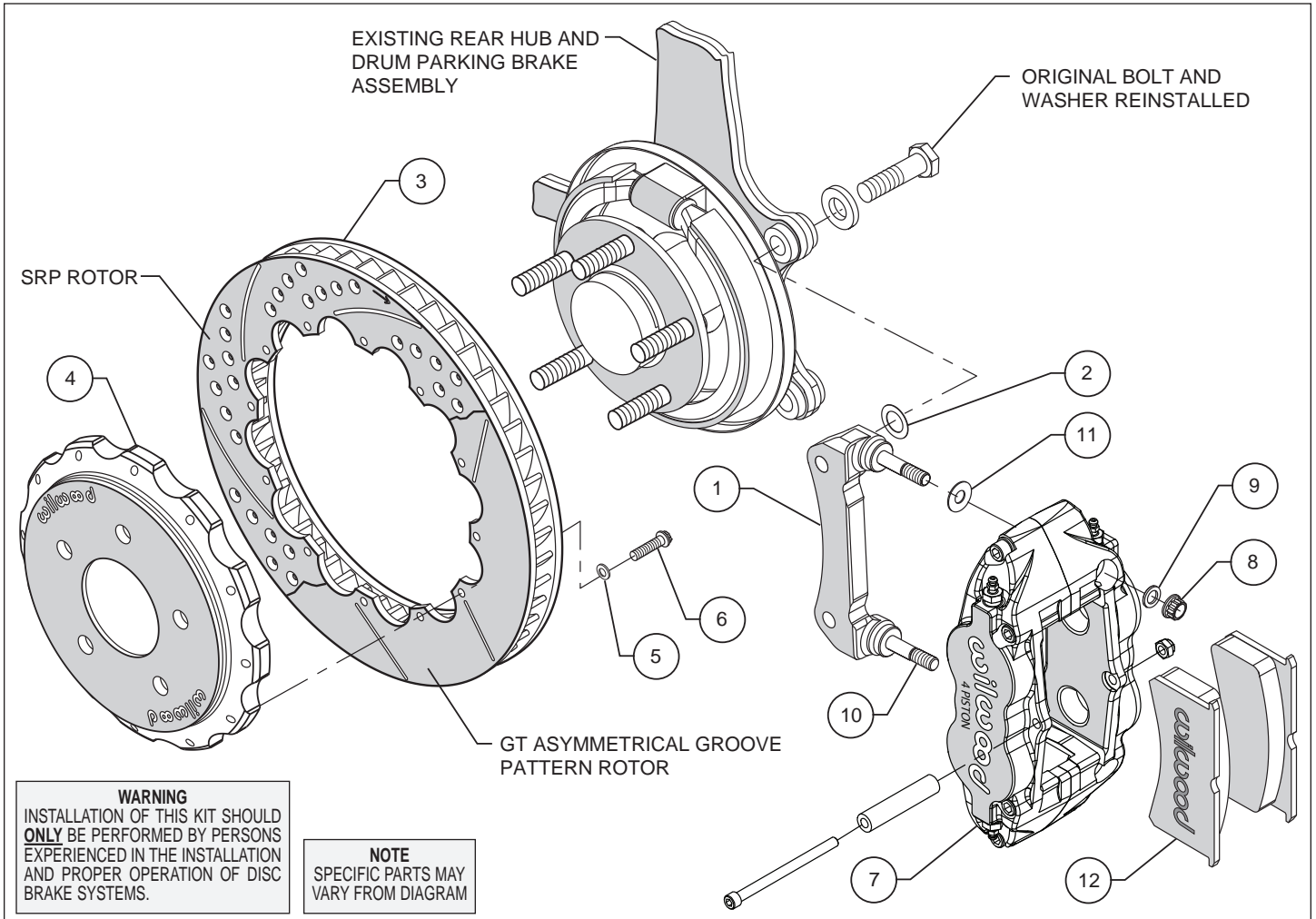

Figure 1. Typical Installation Configuration

Parts List

ITEM NO.	PART NO.	DESCRIPTION	QTY
1	250-8167	Bracket, Caliper Mounting	2
2	240-8127	Shim, .015 Thick	16
3	160-13356/57	GT Rotor - 1.00" X 12.90" Dia, 12 x 8.75" Bolt Circle (one each, right and left)	2
3A	160-13358/59-BK	Rotor, SRP Drilled and Slotted (one each, right and left)	2
4	170-8169	Hat / Drum	2
5	240-11240	Washer, .265 I.D. x .500 O.D. x .063 Thick	24
6	230-6738	Bolt, 1/4-28 x .75 Long, 12 Point	24
7	120-11782-BK	Caliper, Billet Superlite 4R	2
8	230-9183	Nut, 3/8-24, Self-Locking 12 Point	4
9	240-10190	Washer, .391 I.D. x .625 O.D. x .063 Thick	4
10	230-9078	Stud, 3/8-16 x 3/8-24 x 2.5 long (pre installed in bracket)	4
11	240-1159	Shim, .035 Thick	16
12	150-8855K	Pad, BP-10 Compound, Axle Set	1
12A	15Q-6828K	Pad, PolyMatrix "Q" Compound, SRP Rotor Kit	1

NOTES:

Part Number 230-8217 Rotor Bolt Kit, includes part numbers 230-6738 and 240-11240

Part Number 250-8168 Caliper Bracket Mounting Bolt Kit, includes p/n's 230-9183, 230-9078, 240-1159, 240-10190, 240-8127, 250-8167, 240-8969 (not used) & 240-10289 (not used)

Item 3A is an optional item and is included with the "-D" drilled rotor kits. Add "-D" to end of part number when ordering

Item 12A is an optional item and is included with the "-D" drilled rotor kits. Add "-D" to end of part number when ordering

Wilwood offers an optional Braided Stainless Steel Hose Kit. Order part number 220-8177 for C-5, 220-9101 for C-6 (not included in kit)

General Information, Disassembly, and Assembly Instructions

- Installation of this kit should **ONLY** be performed by individuals experienced in the installation and proper operation of disc brake systems. Prior to any attempt to install this kit, please check the following to ensure a trouble free installation.
- Inspect the contents of this kit against the parts list to ensure that all components and hardware are included.
- Make sure this is the correct kit to fit the exact make and model year of your axle. This kit is designed for direct bolt-on installation to 1997 through 2003 model year Chevrolet C-5 Corvette hubs. 2000-2004 OE C-5, Z06 or speciality aftermarket wheels. Check wheel clearance diagram.
- Verify your wheel clearance using Figure 2.
- Verify that the factory axle and stud pattern matches the stud hole pattern in the hats supplied with this kit. Axles that have been modified with different size studs or lug patterns may require modifications to the hat that must be performed by a qualified machinist.

Disassembly

- Disassemble the original equipment rear brakes: Raise the rear wheels off the ground and support the rear suspension according to the vehicle manufacturer's instructions.
- Remove the wheel. Remove the two bolts from the backside of the upright that holds the stock caliper mounting bracket and lift off the bracket and stock caliper as one unit. You may have to unbolt the stock caliper from the caliper bracket before removal. Save the stock caliper mounting bracket bolts and washers, they will be utilized during reassembly. Then slide off the rotor.
- Clean, de-grease and remove all nicks or burrs on the upright assembly as well as the stock caliper bracket bolts.

Assembly Instructions (numbers in parenthesis refer to the part list/diagram on the preceding page):

- The caliper mount bracket assembly (1) should be installed first with clean, dry threads on the mounting bolts. Install the bracket using the original caliper mount bolts. The bracket must tighten squarely against the outboard side of the caliper mount bosses on the upright. Inspect for interference from casting irregularities, machining ridges, burrs, etc. Use one thin shim (2) between the bracket and upright during initial trial fitting. Later, after the caliper, pad, and rotor alignment has been checked, and any necessary shims have been put in place, the mount bolts should be coated with red *Loctite*® 271 and torqued to 65 ft-lbs.

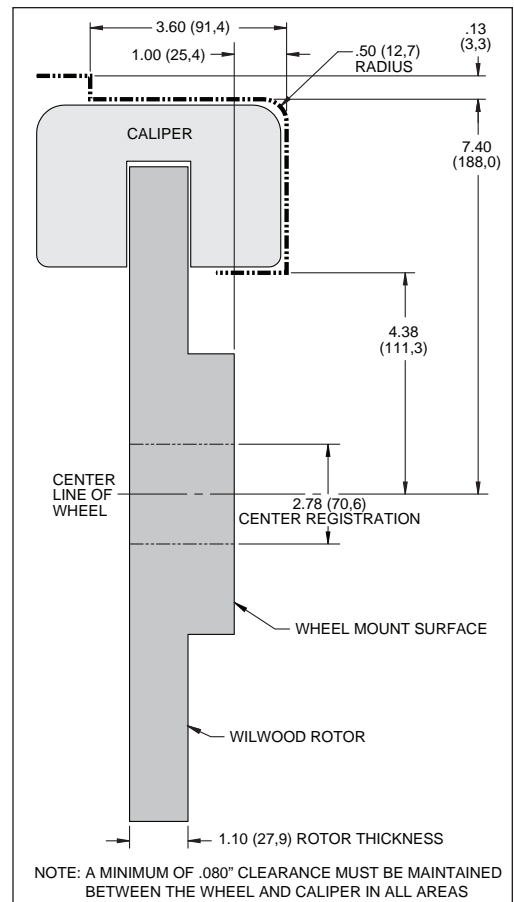

Figure 2. Wheel Clearance Diagram

Assembly Instructions (Continued)

- Assemble the rotor (3) to the hat (4) with the bolts (6) and washers (5) as indicated in the configuration pictured in Figure 1. Using an alternating sequence, apply red *Loctite*® 271 to the threads and torque bolts to 155 in-lb. For an added measure of security, the bolts may be safety wired using standard 0.032 inch diameter stainless steel safety wire as shown in Figure 3. Please refer to Wilwood's data sheet DS-386 for complete safety wire installation instructions.

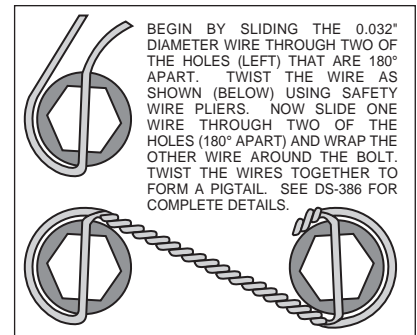

Figure 3. Safety Wire Diagram

instructions.

- Align the hole pattern on the hat and rotor assembly (3 and 4) with the stud pattern on the axle flange. Slide the hat/rotor assembly (3 and 4) over the wheel studs and against the axle flange face. Check to be sure the hat seats squarely against the axle flange face. The axle flange must be free from any rust, debris, casting burrs, machining irregularities, etc. Use several lug nuts to hold the rotor and hat firmly against the axle flange during the next phases of the installation and clearance checking procedures.
- Install one shim (11) over each stud (10) on the radial mount bracket (1). Slide the caliper (7) in place over the studs and rotor and install the washer (9) and lock nut (8) to hold the caliper in place. The caliper bleed screws should be pointing up. Snug the lock nuts (8) and check that the rotor (3) is centered in the caliper (7). Add or subtract .015" shims (2) as necessary between the caliper mount bracket and the caliper mount bosses on the upright assembly to center the caliper.
- Remove the caliper center bridge pad retainer bolt, nut, and tube from the caliper. Slide the brake pads (12) into place. They should install easily without interference. Check that the outside radius of the brake pad is aligned with the outside diameter radius of the rotor face. Add or subtract shims (11) between the caliper and mount bracket to gain the proper alignment. Reinstall the center bridge pad retainer tube, bolt, and lock nut. The locknut should be snug without play in the bolt or tube. Be cautious not to over tighten.
- Remove the lug nuts that were holding the hat in place. Install the wheel and torque the lug nuts to specification. Check to see that the wheel rotates freely without interference.
- Once all clearances have been checked, remove the wheel, caliper, hat, and rotor from the axle flange. Secure the caliper mounting bracket (1) to the axle flange body using red *Loctite*® 271. Torque the bolts to 65 ft-lbs. Reinstall the hat and rotor assembly and again use several lug nuts to hold it in place. Lubricate caliper mounting studs and nuts with lightweight oil, reinstall the caliper, torque the caliper nuts (8) to 30-35 ft-lbs.
- Install the wheel and torque the lug nuts to specification.
- If necessary, adjust the parking brake shoes to factory specifications.

- Install Wilwood's optional stainless steel braided flexline hose kit, part number 220-8177 for C-5, 220-9101 for C-6 (NOT included in kit), see Figure 4. **NOTE:** OEM rubber brake hoses generally cannot be adapted to Wilwood calipers. The caliper inlet fitting is a 1/8-27 NPT. The preferred method is to use steel adapter fittings at the caliper, either straight, 45 or 90 degree and enough steel braided line to allow for full suspension travel and turning radius, lock to lock. **Carefully route lines to prevent contact with moving suspension, brake or wheel components.** Wilwood hose kits are designed for use in many different vehicle applications and it is the installer's responsibility to properly route and ensure adequate clearance and retention for brake hose components.

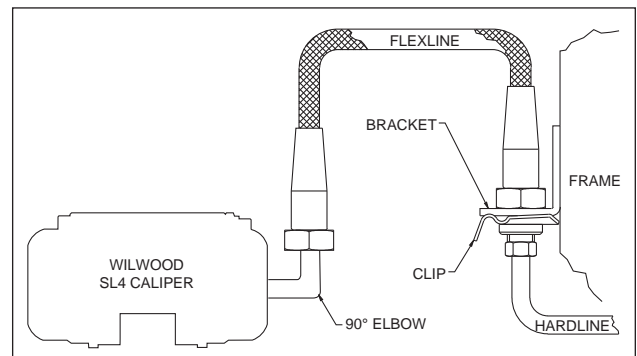

Figure 4. Brake Line Diagram

- Specified brake hose kits may not work with all Years, Makes and Models of vehicle that this brake kit is applicable to, due to possible OEM manufacturing changes during a production vehicle's life. It is the installer's responsibility to ensure that all fittings and hoses are the correct size and length, to ensure proper sealing and that they will not be subject to crimping, strain and abrasion from vibration or interference with suspension components, brake rotor or wheel.
- In absence of specific instructions for brake line routing, the installer must use his best professional judgment on correct routing and retention of lines to ensure safe operation. Test vehicle brake system per the 'minimum test' procedure stated within this document before driving. After road testing, inspect for leaks and interference. Initially after install and testing, perform frequent checks of the vehicle brake system and lines before driving, to confirm that there is no undue wear or interference not apparent from the initial test. Afterwards, perform periodic inspections for function, leaks and wear in a interval relative to the usage of vehicle.
- Bleed the brake system. Reference the general information and recommendations on page 5 for proper bleeding instructions.

Additional Information and Recommendations

• Fill and bleed the new system with Wilwood Hi-Temp[®] 570 grade fluid or higher. For severe braking or sustained high heat operation, use Wilwood EXP 600 Plus Racing Brake Fluid. Used fluid must be completely flushed from the system to prevent contamination.
NOTE: *Silicone DOT 5 brake fluid is **NOT** recommended for racing or performance driving.*

• To properly bleed the brake system, begin with the caliper farthest from the master cylinder. Bleed the outboard bleed screw first, then the inboard. Repeat the procedure until all calipers in the system are bled, ending with the caliper closest to the master cylinder.
NOTE: *When using a new master cylinder, it is important to bench bleed the master cylinder first.*

• Test the brake pedal. It should be firm, not spongy and stop at least 1 inch from the floor under heavy load.
If the brake pedal is spongy, bleed the system again.

If the brake pedal is initially firm, but then sinks to the floor, check the system for fluid leaks. Correct the leaks (if applicable) and then bleed the system again.

If the brake pedal goes to the floor and continued bleeding of the system does not correct the problem, a master cylinder with increased capacity (larger bore diameter) may be required. Wilwood offers various lightweight master cylinders with large fluid displacement capacities.

• **NOTE:** *With the installation of after market disc brakes, the wheel track may change depending on the application. Check your wheel offset before final assembly.*

• If after following the instructions, you still have difficulty in assembling or bleeding your Wilwood disc brakes, consult your local chassis builder, or retailer where the kit was purchased for further assistance.

Brake Testing

WARNING • DO NOT DRIVE ON UNTESTED BRAKES BRAKES MUST BE TESTED AFTER INSTALLATION OR MAINTENANCE MINIMUM TEST PROCEDURE

- Make sure pedal is firm: Hold firm pressure on pedal for several minutes, it should remain in position without sinking. If pedal sinks toward floor, check system for fluid leaks. **DO NOT** drive vehicle if pedal does not stay firm or can be pushed to the floor with normal pressure.
- At very low speed (2-5 mph) apply brakes hard several times while turning steering from full left to full right, repeat several times. Remove the wheels and check that components are not touching, rubbing, or leaking.
- Carefully examine all brake components, brake lines, and fittings for leaks and interference.
- Make sure there is no interference with wheels or suspension components.
- Drive vehicle at low speed (15-20 mph) making moderate and hard stops. Brakes should feel normal and positive. Again check for leaks and interference.
- Always test vehicle in a safe place where there is no danger to (or from) other people or vehicles.
- Always wear seat belts and make use of all safety equipment.

Pad and Rotor Bedding

BEDDING STEPS FOR NEW PADS AND ROTORS – ALL COMPOUNDS

Once the brake system has been tested and determined safe to operate the vehicle, follow these steps for the bedding of all new pad materials and rotors. These procedures should only be performed on a race track, or other safe location where you can safely and legally obtain speeds up to 65 MPH, while also being able to rapidly decelerate.

- Begin with a series of light decelerations to gradually build some heat in the brakes. Use an on-and-off the pedal technique by applying the brakes for 3-5 seconds, and then allow them to fully release for a period roughly twice as long as the deceleration cycle. If you use a 5 count during the deceleration interval, use a 10 count during the release to allow the heat to sink into the pads and rotors.
- After several cycles of light stops to begin warming the brakes, proceed with a series of medium to firm deceleration stops to continue raising the temperature level in the brakes.
- Finish the bedding cycle with a series of 8-10 hard decelerations from 55-65 MPH down to 25 MPH while allowing a proportionate release and heat-sinking interval between each stop. The pads should now be providing positive and consistent response.
- If any amount of brake fade is observed during the bed-in cycle, immediately begin the cool down cycle.
- Drive at a moderate cruising speed, with the least amount of brake contact possible, until most of the heat has dissipated from the brakes. Avoid sitting stopped with the brake pedal depressed to hold the car in place during this time. Park the vehicle and allow the brakes to cool to ambient air temperature.

COMPETITION VEHICLES

- If your race car is equipped with brake cooling ducts, blocking them will allow the pads and rotors to warm up quicker and speed up the bedding process.
- Temperature indicating paint on the rotor and pad edges can provide valuable data regarding observed temperatures during the bedding process and subsequent on-track sessions. This information can be highly beneficial when evaluating pad compounds and cooling efficiencies.

POST-BEDDING INSPECTION – ALL VEHICLES

- After the bedding cycle, the rotors should exhibit a uniformly burnished finish across the entire contact face. Any surface irregularities that appear as smearing or splotching on the rotor faces can be an indication that the brakes were brought up to temperature too quickly during the bedding cycle. If the smear doesn't blend away after the next run-in cycle, or if chatter under braking results, sanding or resurfacing the rotors will be required to restore a uniform surface for pad contact.

PRE-RACE WARM UP

- Always make every effort to get heat into the brakes prior to each event. Use an on-and-off the pedal practice to warm the brakes during the trip to the staging zone, during parade laps before the flag drops, and every other opportunity in an effort to build heat in the pads and rotors. This will help to ensure best consistency, performance, and durability from your brakes.

DYNO BEDDED COMPETITION PADS AND ROTORS

- Getting track time for a proper pad and rotor bedding session can be difficult. Wilwood offers factory dyno-bedded pads and rotors on many of our popular competition pads and **Spec 37** GT series rotors. Dyno-bedded parts are ready to race on their first warm up cycle. This can save valuable time and effort when on-track time is either too valuable or not available at all, Dyno-bedding assures that your pads and rotors have been properly run-in and are ready to go. Contact your dealer or the factory for more information on Wilwood Dyno-Bedding services.

NOTE:

NEVER allow the contact surfaces of the pads or rotors to be contaminated with brake fluid. Always use a catch bottle with a hose to prevent fluid spill during all brake bleeding procedures.

Parking Brake

WARNING • PARKING BRAKE

- Parking brake must be properly adjusted before use and must be manually readjusted for wear if parking brake handle or foot lever travel becomes excessive.
 - The holding ability of the brake should be tested by stopping on a sloping surface and applying the parking brake while holding car with the hydraulic foot brake. This should be accomplished both facing up and down hill.
 - Do not rely exclusively on the parking brake to hold the car; Curb wheels as recommended by the applicable diagram and put gear selector in park, or shift into first gear or reverse with a manual transmission.
-
- Diagram A - When parking facing downhill, turn front wheels towards the curb or right shoulder. This will keep from rolling into traffic if the brakes become disengaged.
 - Diagram B - Turn the steering wheel to the left so the wheels are turned towards the road if you are facing uphill with a curb. The tires will catch the curb if the car rolls backward.
 - Diagram C - When facing uphill without a curb, turn the wheels sharply to the right. If the vehicle rolls, it will go off the road rather than into traffic.
 - When parking on a hill, always set the parking brake and move the gear selector into park, or shift into first or reverse gear if your vehicle has a manual transmission.

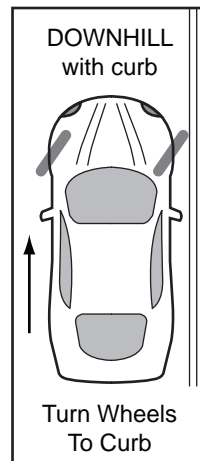

Diagram A

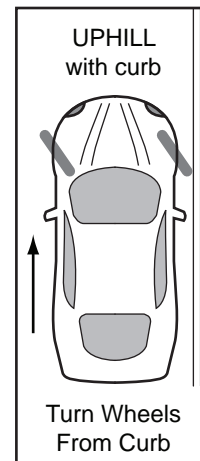

Diagram B

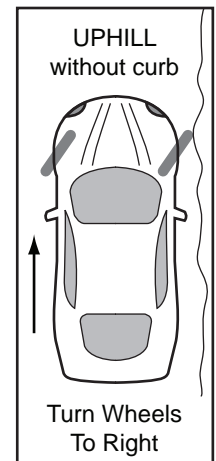

Diagram C