



AUTOMOTIVE PRODUCTS,

INSTALLATION INSTRUCTIONS

PRO TRAX[®] 5 WHEEL-TO-WHEEL

APPLICATION:

2007-2015 Toyota Tundra D-Cab 6.5 ft Bed

PART NUMBER: 21-534170, 21-534175

| ITEM | QUANTITY | DESCRIPTION | TOOLS NEEDED |
|------|----------|---|---------------|
| 1,2 | 2 | STEP BAR ASSEMBLY DRIVER/PASSENGER | 13MM SOCKET |
| 3 | 2 | FRONT MOUNTING BRACKET | TORQUE WRENCH |
| 4 | 2 | MIDDLE MOUNTING BRACKET | RATCHET |
| 5 | 2 | REAR MOUNTING BRACKET | 12MM SOCKET |
| 6 | 12 | M8 HEX HEAD CAP SCREW (YELLOW ZINC) | 19MM SOCKET |
| 7 | 12 | M8 FLAT WASHER (YELLOW ZINC) | HEX KEY |
| 8 | 12 | M8 SPRING LOCK WASHER (YELLOW ZINC) | |
| 9 | 12 | M10 HEX BUTTON HEAD SOCKET CAP SCREW (BLACK ZINC) | |
| 10 | 12 | M10 FLAT WASHER (BLACK ZINC) | |
| 11 | 12 | M10 INTERNAL TOOTHED LOCK WASHER (BLACK ZINC) | |

ANTI-SEIZE LUBRICANT MUST BE USED ON ALL STAINLESS STEEL FASTENERS TO PREVENT THREAD DAMAGE AND GALLING

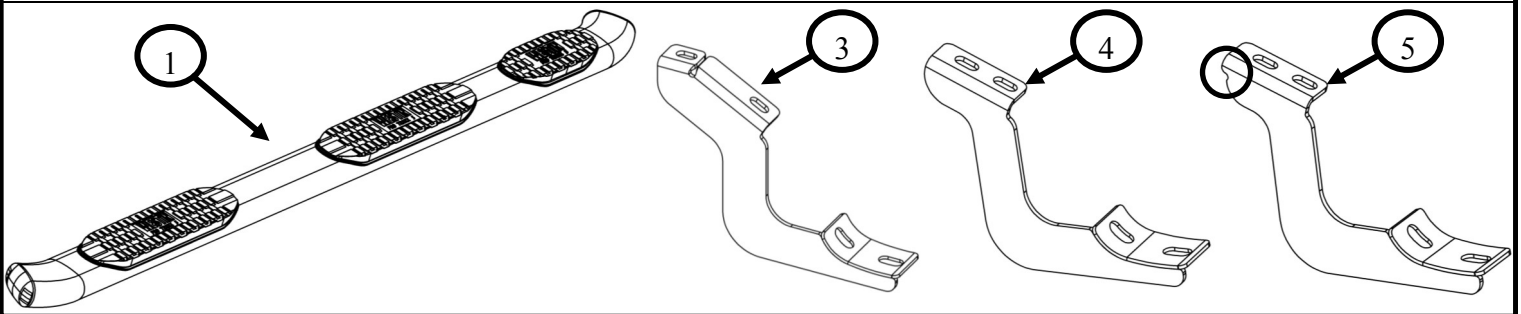

PROCEDURE

1. Remove contents from box, verify if all parts listed are present and free from damage. Carefully read and understand all instructions before attempting installation.
Failure to identify damage before installation could lead to a rejection of any claim.
2. Start installation on the driver's side. On the rocker panel, find locations of factory bolts. Remove factory hardware and discard. (Note: Brackets will be installed in these locations with provided hardware.) **See Fig. 1 & 2.**
3. Locate Front, Middle, and Rear Mounting Brackets (Items 3, 4, 5). Using the supplied M8 hardware, loosely install the brackets to the rocker panel. **See Fig. 3, 4, & 5.** (Note: Item 5 has a notch to differentiate from Item 4. See image above.)
4. Locate the Driver Step Bar Assembly (Item 1) and align it with the brackets. **See Fig. 6.**
5. Loosely install the Driver Step Bar Assembly using supplied M10 hardware. **See Fig. 7.**
6. Align and adjust the step bar and brackets as necessary then tighten and torque all fasteners as follows: M8 to 20 ft-lbs, M10 30 ft-lbs.
7. Repeat for the passenger side.

Location for Item 3

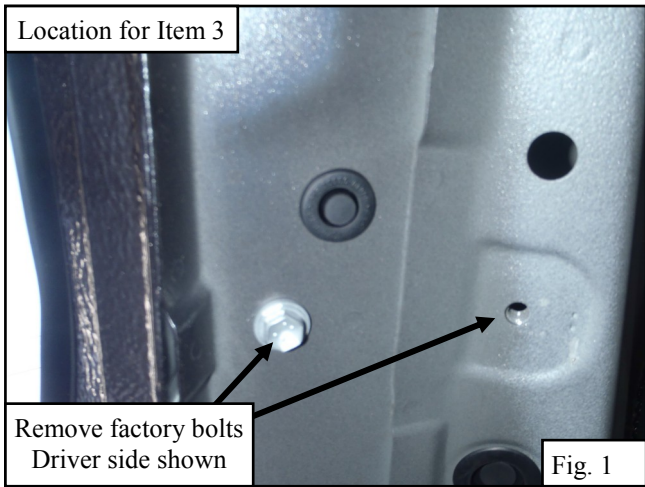

Remove factory bolts
Driver side shown

Fig. 1

Location for Item 4 & 5

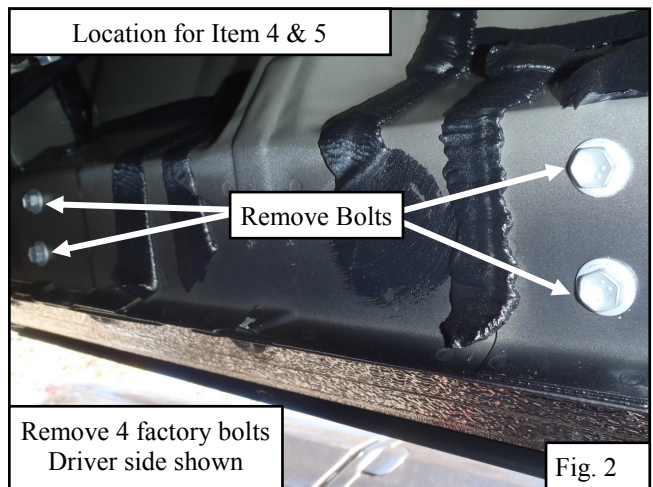

Remove Bolts

Remove 4 factory bolts
Driver side shown

Fig. 2

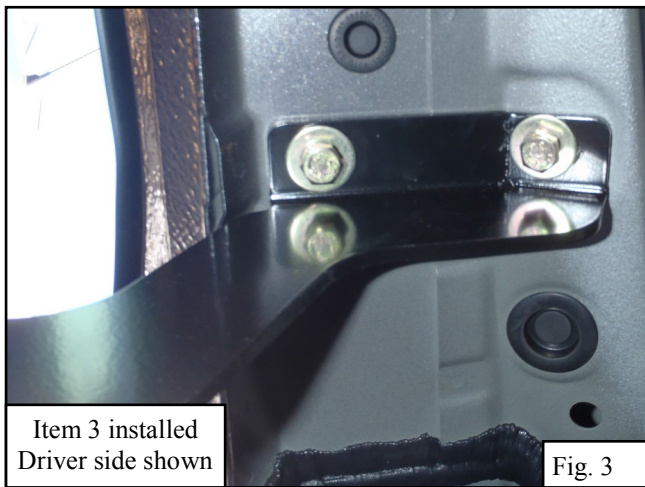

Item 3 installed
Driver side shown

Fig. 3

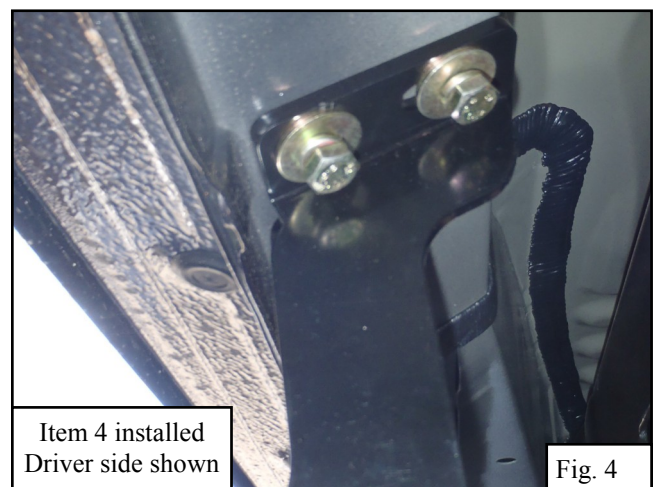

Item 4 installed
Driver side shown

Fig. 4

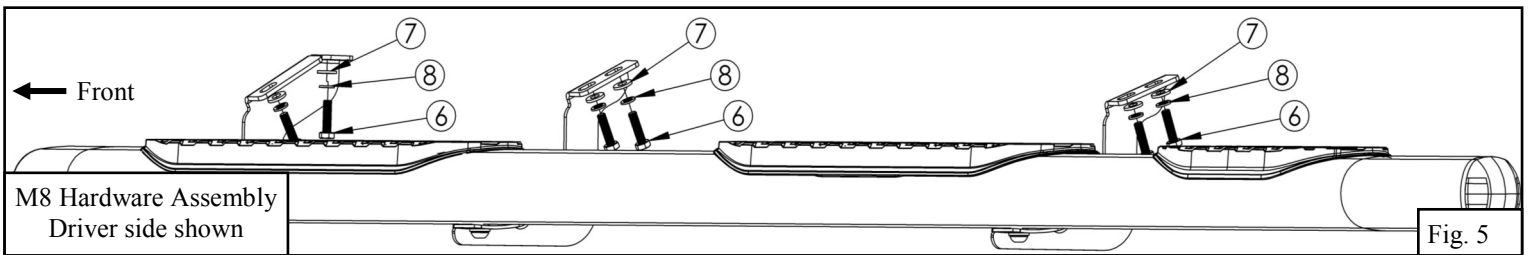

M8 Hardware Assembly
Driver side shown

Fig. 5

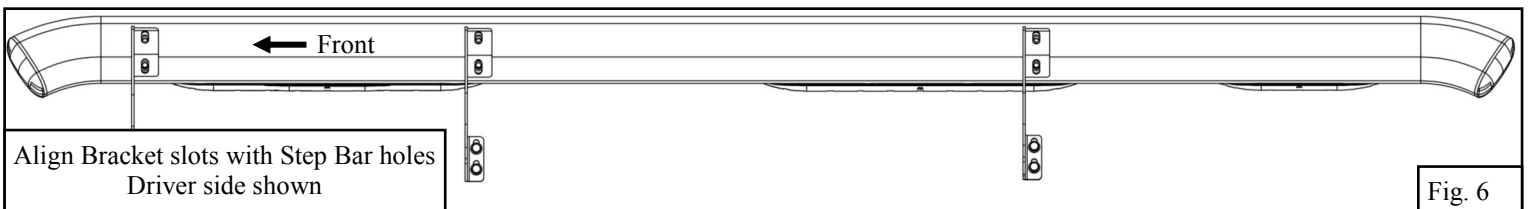

Align Bracket slots with Step Bar holes
Driver side shown

Fig. 6

M10 Hardware Assembly
Driver side shown

Fig. 7

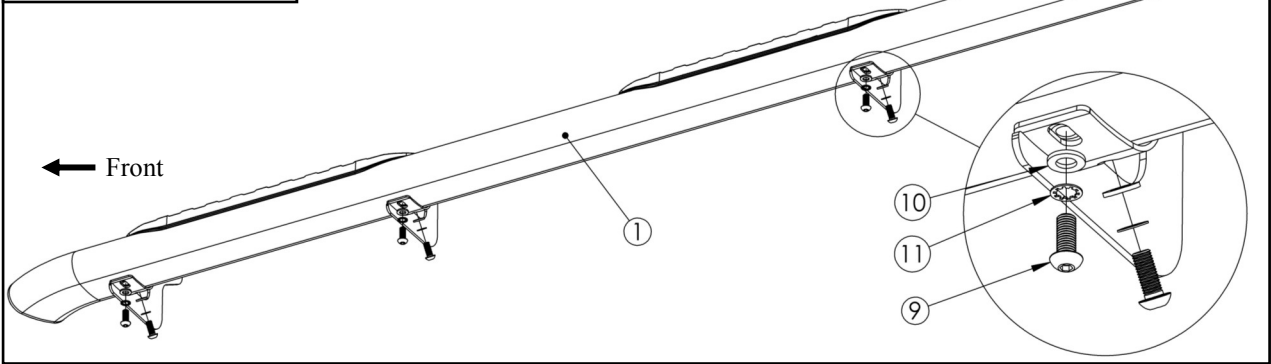

CARE INSTRUCTIONS

- REGULAR WAXING IS RECOMMENDED. DO NOT USE ANY TYPE OF POLISH OR WAX THAT MAY CONTAIN ABRASIVES.
- STAINLESS STEEL PRODUCTS CAN BE CLEANED WITH MILD SOAP AND WATER. STAINLESS STEEL POLISH SHOULD BE USED TO POLISH SMALL SCRATCHES.
- GLOSS BLACK FINISHES SHOULD BE CLEANED WITH MILD SOAP AND WATER.

When it comes to quality side steps and nerf bars, Westin is the brand you can depend on.