



SIGNATURE OF QUALITY

AUTOMOTIVE PRODUCTS, INC.

INSTRUCTIONS

APPLICATION: 2006-2008 DODGE RAM QUAD CAB
PART NUMBER: 21-2310, 21-2315

ITEM	QUANTITY	CONTENTS	TOOLS
1,2	2	STEP BAR (DRIVER & PASSENGER SIDE)	3/4" SAE SOCKET
2	2	FRONT BRACKET	17MM SOCKET
3	2	REAR BRACKET	RATCHET
4	2	FRONT SUPPORT STRAP (A)	
5	2	REAR SUPPORT STRAP (B)	
6	8	PLASTIC RETAINER	
7	8	10MM LOCK WASHER	
8	8	10MM X 30MM BOLT PLATE	
9	8	10MM FLAT WASHER	
10	8	10MM HEX NUT	
11	4	1/2" X 2" HEX HEAD BOLT	
12	4	1/2" LOCK WASHER	
13	4	1/2" FLAT WASHER	
14	4	M12 X 110MM HEX BOLT	
15	4	M12 LARGE O.D. FLAT WASHER	

- Remove contents from box and check for damage. Verify all parts are present. Read and understand instructions before beginning.
- Inside the driver side rocker panel underneath the vehicle will be four factory mounting locations for running boards. The slots are covered by pieces of tape that must be removed for installation. (FIGURE 4)
- Attach the plastic retainers to the 10mm bolt plates by threading them halfway on. (FIGURE 5)
- Insert the bolt plates into the front driver factory running board slots, The plastic retainer will keep the bolt plate from falling into the rocker panel. (FIGURE 6)
- Thread the retainer until they are flush with the sheet metal. (FIGURE 7)
- Secure the front driver side mounting bracket with the single slot facing the front tire using the supplied 10MM lock washers, flat washers, and hex nuts. (FIGURE 8)
- Repeat steps 1-5 for the driver side rear mounting bracket.
- Remove the driver side body/frame mount bolt. Using the supplied M12 bolt and large washer, secure the front support strap to the body mount. Repeat for the rear. (FIGURE 9)
- Using the supplied 1/2" hardware, attach the drive side bar to the mounting brackets, at the same time attaching the support strap behind the mounting bracket. (FIGURE 10)
- Tighten all remaining hardware.
- Repeat steps 1-9 for passenger side.
(It is recommended to recheck and tighten hardware occasionally)

FINISH PROTECTION

Westin products have a high quality finish that must be cared for like any other exposed finish on the vehicle. Protect the finish with a non-abrasive automotive wax, (e.g. Pure Carnauba) on a regular basis. The use of any soap, polish or wax that contains an abrasive is detrimental, as the compounds scratch the finish and open it to corrosion.



SIGNATURE OF QUALITY

Westin

SIGNATURE OF QUALITY

AUTOMOTIVE PRODUCTS, INC.

INSTRUCTIONS

APPLICATION: 2006-2008 DODGE RAM QUAD CAB
PART NUMBER: 21-2310, 21-2315

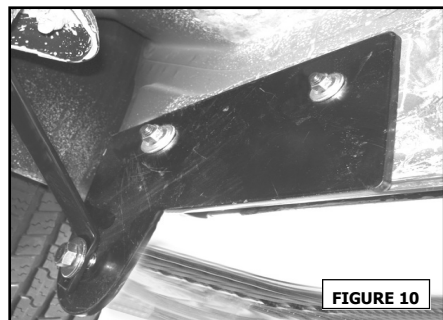
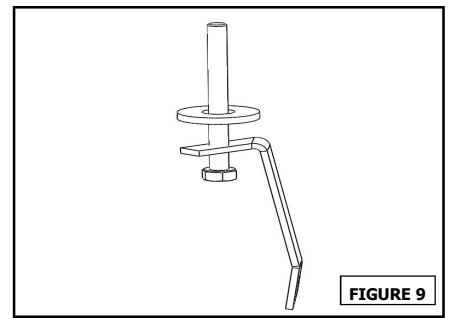
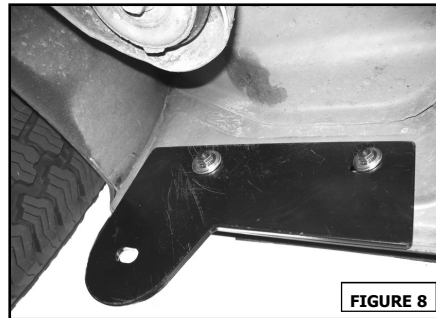
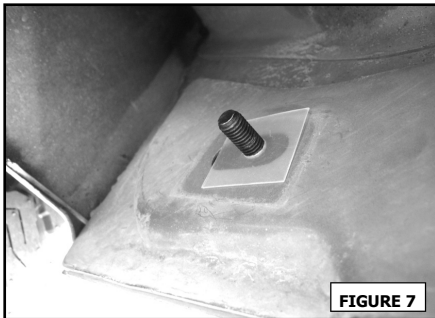
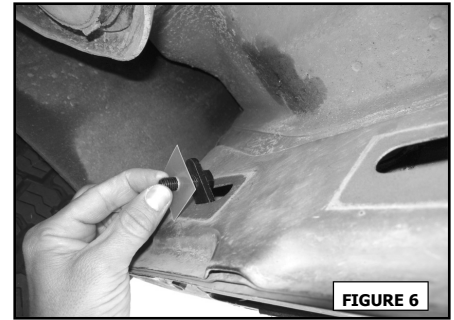
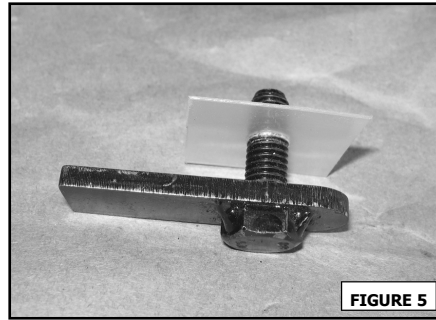
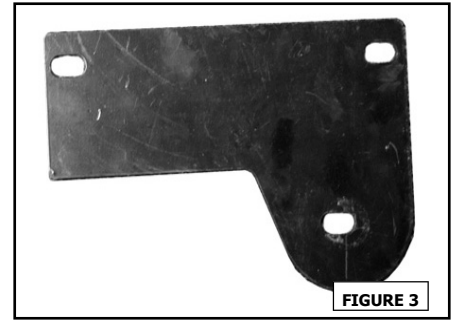
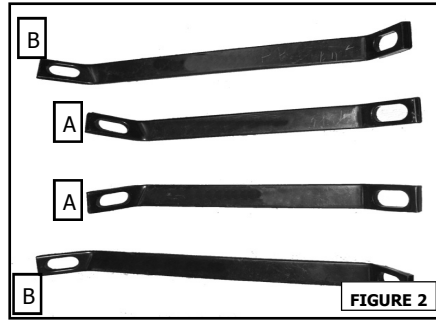
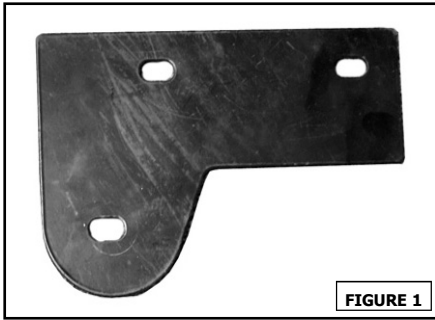

Feel the difference with Westin.

Check out the collection of side steps and nerf bars we offer.