



AUTOMOTIVE PRODUCTS, INC.

INSTALLATION INSTRUCTIONS

APPLICATION: 2011-UP DODGE DURANGO
 APP. PART # 23-3620, 23-3625, 21-3620, 21-3625
 E-SERIES STEP BARS/ 4" OVAL STEP BARS

ITEM	QUANTITY	DESCRIPTION	TOOLS NEEDED
1	2	STEPBARS	18MM SOCKET
2,3	2	FRONT MOUNTING BRACKET (2) DRIVERS SIDE, (3) PASSENGER SIDE	16MM SOCKET
4	1	DRIVER FRONT INNER SUPPORT BRACKET (4WD W/ SKID PLATE)	13MM SOCKET
5	1	DRIVER FRONT INNER SUPPORT BRACKET (2WD/4WD W/O SKID PLATE)	10MM SOCKET
6,7	2	PASSENGER (RIGHT) OUTER SUPPORT BRACK- ETS (FITS PASSNGER FRONT AND REAR ONLY)	RATCHET
8	1	PASSENGER INNER SUPPORT BRACKET (ALL)	TORQUE WRENCH
9,10	2	REAR MOUNTING BRACKETS (9) DRIVERS SIDE, (10) PASSENGER SIDE	
11	2	REAR INNER "L" SUPPORT BRACKET	
12	4	M12 X 40MM BOLT PLATES	
13	4	M10 X 35MM LONG BOLT PLATES	
14	2	M10 X 35MM SHORT BOLT PLATES	
15	2	M12 X 35MM HEX HEAD BOLTS	
16	4	M12 LARGE FLAT WASHERS	
17	4	M12 SMALL FLAT WASHERS	
18	6	M12 LOCK WASHERS	
19	6	M12 HEX NUTS	
20	1	M10 X 40MM HEX HEAD BOLTS	
21	2	M10 X 35MM HEX HEAD BOLTS	
22	4	M10 X 30MM HEX HEAD BOLTS	
23	16	M10 FLAT WASHERS	
24	6	M10 LOCK WASHERS	
25	6	M10 HEX NUTS	
26	5	M10 NYLOCK NUTS	
27	8	M8 X 25MM HEX HEAD BOLTS	
28	8	M8 FLAT WASHERS	
29	8	M8 LOCK WASHERS	
30	2	M6 X 30MM HEX HEAD BOLT	
31	6	M6 X 25MM HEX HEAD BOLTS	
32	16	M6 FLAT WASHERS	
33	8	M6 NYLOCK NUTS	

1. Remove contents from box, verify all parts listed are present and free from damage. Carefully read and

understand all instructions before attempting installation

2. Starting at the driver side front, remove the rubber plug filling the oval hole in the bottom of the rocker panel, **(Figure 1)**. Insert (1) M12 x 40mm Bolt Plate into the hole and rotate 90-degrees to the slot, **(Figure 2A & 2B)**. **NOTE:** Repeat instructions for all Bolt Plate installations. Select (1) Driver Side Outer Support Bracket and secure it to the Bolt Plate with (1) 12mm Lock Washer, (1) M12 x 24mm Small Flat Washer and (1) M12 Hex Nut, **(Figure 3)**. Do not tighten hardware at this time.

3. Next, select the Driver Side Front Mounting Bracket. Bolt the Mounting Bracket to the back of the pinch weld with (2) M6 x 25mm Hex Bolts, (4) M6 Flat Washers and (2) M6 Nylock Nuts, **(Figure 4)**.

4. Select the correct driver side Inner Support Bracket for your application, **For 2wd vehicles or 4WD without optional factory transfer case skid plate:** Locate the oval hole in the bottom of the frame channel. Insert (1) M10 x 35mm Short Bolt Plate into the hole and rotate it 90-degrees, **(Figure 5A & 5B)**. Select the Driver Side Front Inner Support Bracket. Bolt the Bracket to the previously installed Bolt Plate with (1) M10 Flat Washer, (1) M10 Lock Washer and (1) M10 Hex Nut, **(Figure 6)**. Line up the remaining hole in the Support Bracket with the hole in the center of the Front Mounting Bracket. Bolt the two Brackets together with (1) M12 x 35mm Hex Bolt, (2) M12 x 32mm OD Large Flat Washers, (1) M12 Lock Washer and (1) M12 Hex Nut, **(Figure 6)**. Line up the hole in the Outer Support Bracket with the hole in the Front Mounting Bracket. **Note:** The Outer Support Bracket will line up on the forward facing side of the Mounting Bracket. Bolt the two Brackets together with (1) M10 x 30mm Hex Bolt, (2) M10 Flat Washers and (1) M10 Nylon Lock Nut, **(Figures 5A & 6)**. Do not tighten hardware at this time. **For 4WD vehicles with optional transfer case skid plate. Step below applies to driver side Inner Support Bracket installation only. Use Step above for passenger side Inner Support Bracket installation.** On the driver side, locate the hex bolt securing the rear of the skid plate to the bottom of the frame channel, **(Figure 7A)**. Remove the factory hex bolt. Select the Driver Side Front Inner Support Bracket for models **W/Factory Skid Plate**, **(Figure 7B)**. Place the Bracket over the skid plate and bolt it in place with (1) M10 x 40mm Hex Bolt, (1) M10 Flat Washer and (1) M10 Lock Washer. Leave hardware loose at this time. Line up the (2) holes in the outer end of the Support Bracket with the holes in the Front Mounting Bracket. Line up the hole in the Outer Support Bracket, (See Step 1), with the hole in the Mounting Bracket and Support Bracket, **(Figure 7A)**. **Note:** The Outer Support Bracket will line up on the **rear facing** side of the Mounting Bracket, **(Figure 7B)**. Bolt the (3) Brackets together with (2) M10 x 35mm Hex Bolts, (4) 10mm Flat Washers and (2) M10 Nylon Lock Nuts. Do not tighten hardware at this time. **Note:** Use **Step** above for passenger side Inner Support Bracket installation instructions for all vehicles.

5. Move to the driver side rear of the vehicle and remove the rubber plug in the bottom of the rocker panel as described in **Step 1**. Insert (1) M12 Bolt Plate into the oval hole and rotate 90-degrees to the slot, **(Figure 8A)**. Select (1) Driver Side Outer Support Bracket and secure it to the Bolt Plate with (1) M12 Lock Washer, (1) M12 x 20mm Small Flat Washer and (1) M12 Hex Nut. Locate the oval hole in the floor panel on the other side of the pinch weld, forward of this location. Insert (1) M10 Large Bolt Plate into the hole and rotate 90-degrees to the oval hole, **(Figure 8B)**.

6. Next, select the Driver Side Rear Mounting Bracket. Bolt the Mounting Bracket to the back of the pinch weld with (1) M6 x 25mm Hex Bolt, (2) M6 Flat Washers and (1) M6 Nylon Lock Nut installed in the rearmost mounting hole, **(Figure 9)**. Hang the Bracket from the previously installed forward Bolt Plate with (1) M10 Flat Washer, (1) M10 Lock Washer and (1) M10 Hex Nut, **(Figure 10)**. Line up the hole in the Outer Support Bracket with the hole in the Mounting

Bracket. Bolt the Brackets together with (1) M10 x 30mm Hex Bolt, (2) M10 Flat Washers, (1) M10 Nylon Lock Nut, (Figure 10 & 13). Note: The Outer Support Bracket will line up on the forward facing side of the Mounting Bracket. Do not tighten hardware at this time.

7. Locate the oval hole behind the midpoint of the Bracket. Insert (1) M10 Large Bolt Plate into the hole and rotate 90-degrees to the oval hole as described in Step 4, (Figure 10). Select the Rear Inner Support Bracket. Bolt the Support Bracket to the Bolt Plate with (1) M10 Flat Washer, (1) M10 Lock Washer and (1) M10 Hex Nut, (Figure 11). Line up the remaining hole in the Support Bracket with the hole in the middle of the Mounting Bracket. Bolt the Support Bracket to the Mounting Bracket with the longer (1) M6 x 30mm Hex Bolt, (2) M6 Flat Washers and (1) M6 Nylon Lock Nut, (Figure 12). Do not tighten hardware.

8. Select the left Sidebar and carefully place it in position on the (2) Mounting Brackets. Line up the threaded holes in the Sidebar with the slots in the Brackets and bolt it in place with the included (4) M8 x 25mm Hex Bolts, (4) M8 Lock Washers and (4) M8 Flat Washers, (Figure 13). Snug all hardware but do not tighten at this time.

9. Align step bars as needed and fully tighten hardware, torque all M12 to 45-50 ft lbs. M10 to 35-40 ft lbs, M8 to 25-30 ft lbs, and M6 to 15-20 ft lbs

10. Repeat steps 2-9 for passenger side

CARE INSTRUCTIONS

- REGULAR WAXING IS RECOMMENDED. DO NOT USE ANY TYPE OF POLISH OR WAX THAT MAY CONTAIN ABRASIVES
- STAINLESS STEEL PRODUCTS CAN BE CLEANED WITH MILD SOAP AND WATER. STAINLESS STEEL POLISH SHOULD BE USED TO POLISH SMALL SCRATCHES.
- GLOSS BLACK FINISHES SHOULD BE CLEANED WITH MILD SOAP AND WATER

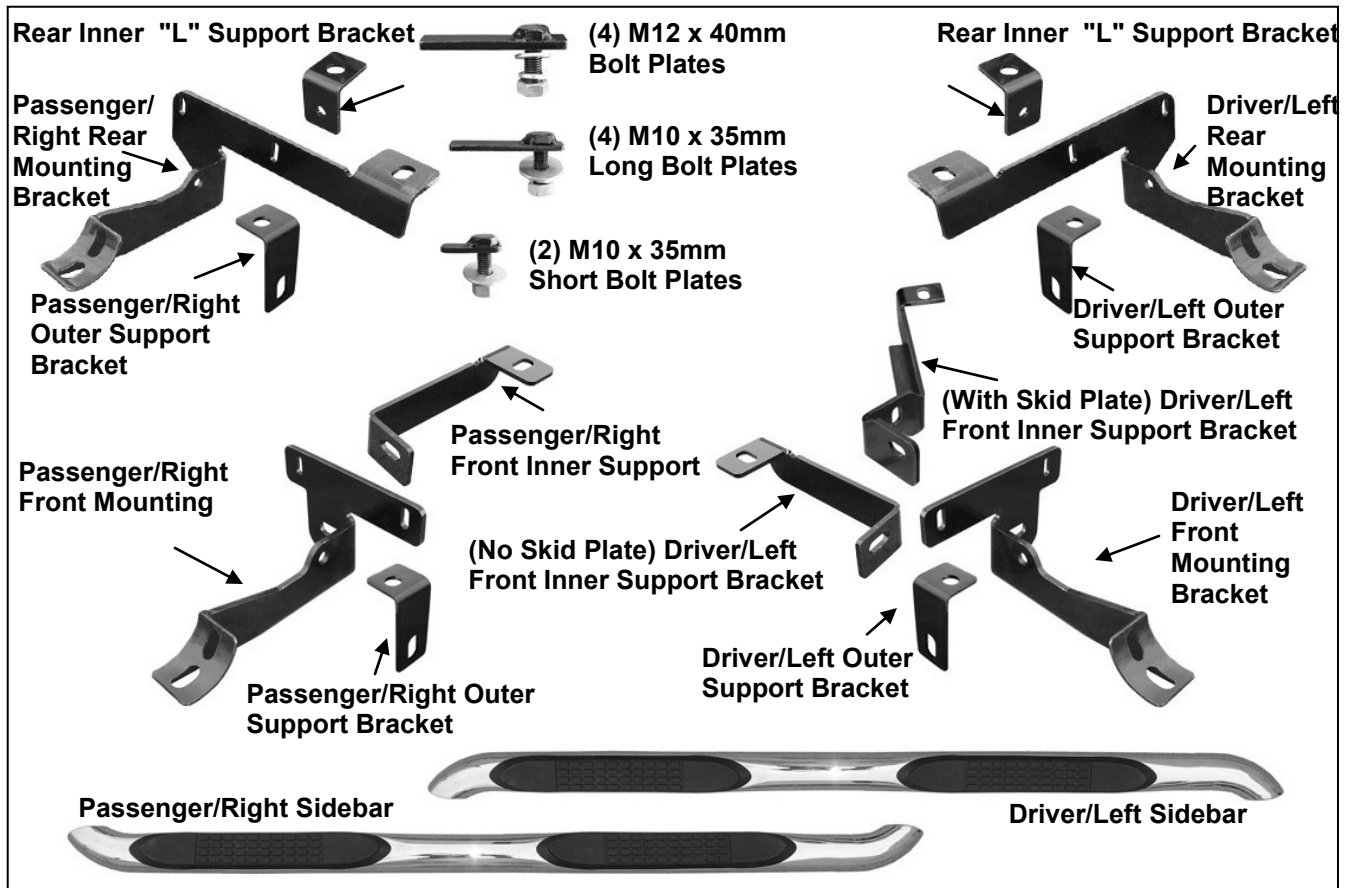



INSTALLATION COMPLETE

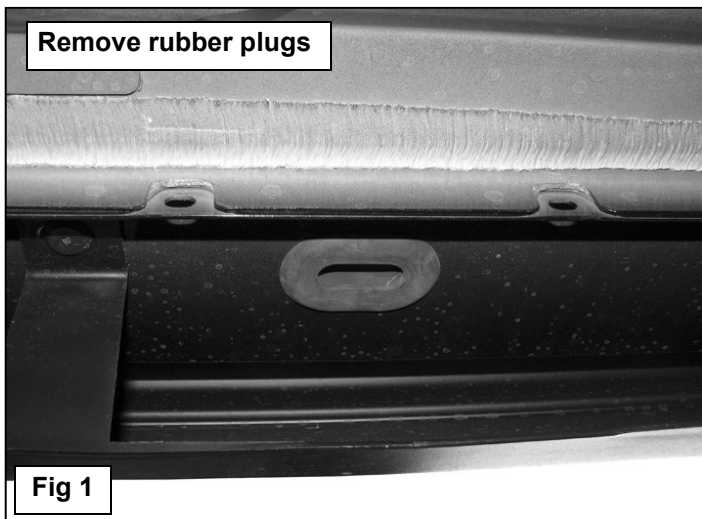

Remove rubber plugs

Fig 1

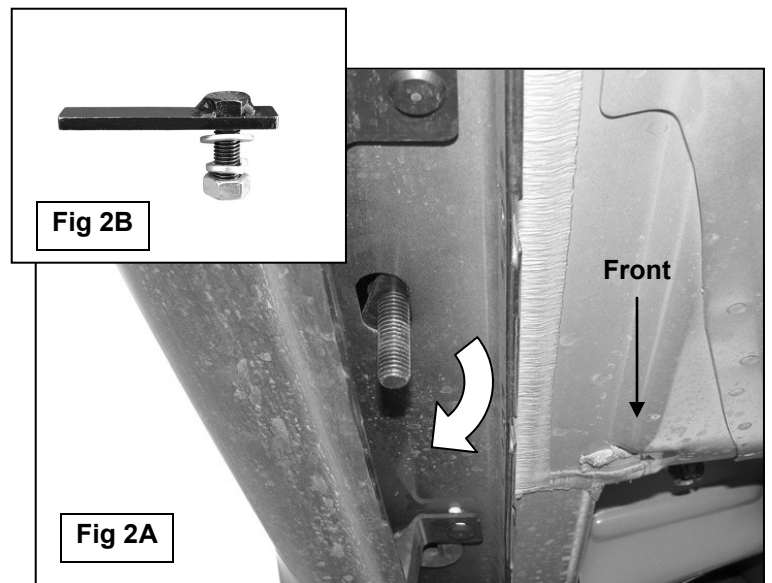
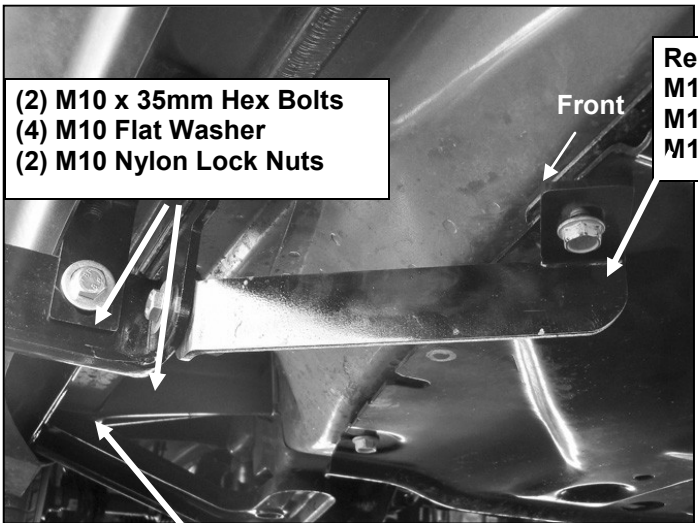
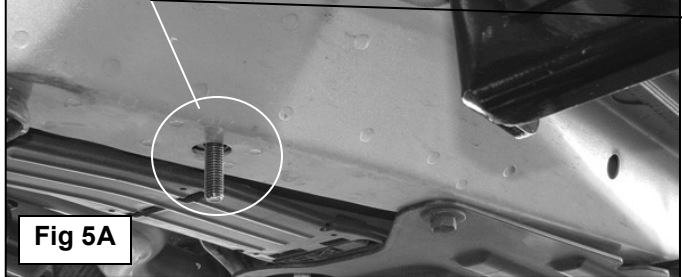
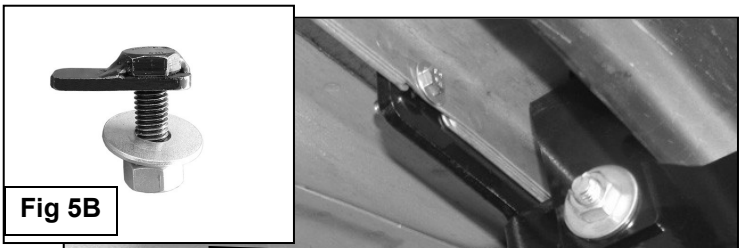
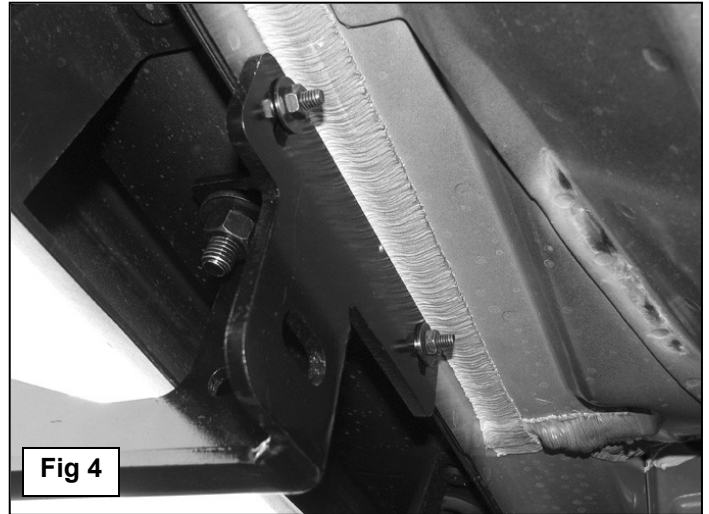
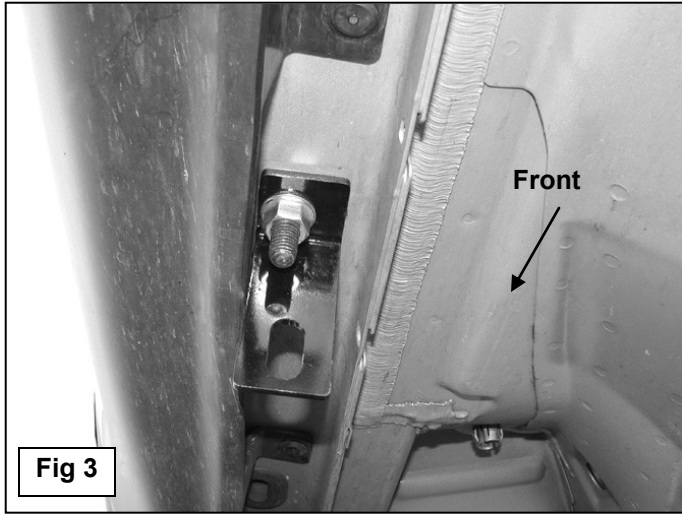

Fig 2B

Fig 2A

Front



Replace factory hex bolt with:
 M10 x 40mm Hex Bolt
 M10 Lock Washer
 M10 Flat Washer

- (2) M10 x 35mm Hex Bolts
- (4) M10 Flat Washer
- (2) M10 Nylon Lock Nuts

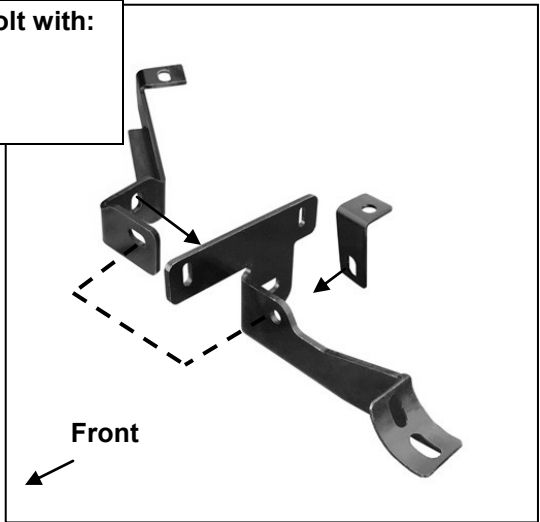

(Fig 7A) Driver side Front Support Bracket Installation for 4WD Vehicles With Transfer Case Skid Plate Only. NOTE: Move Outer Support Bracket to back of Mounting Bracket

(Fig 7B) Driver side Front Support Bracket for 4WD Vehicles With Transfer Case Skid Plate Only

Outer Support Bracket

- (1) M12 x 40mm Bolt Plate
- (1) M12 x 24mm Small Flat Washer
- (1) M12 Lock Washer



- (1) M6 x 25mm Hex Bolt
- (2) M6 Flat Washers
- (1) M6 Nylon Lock Nut

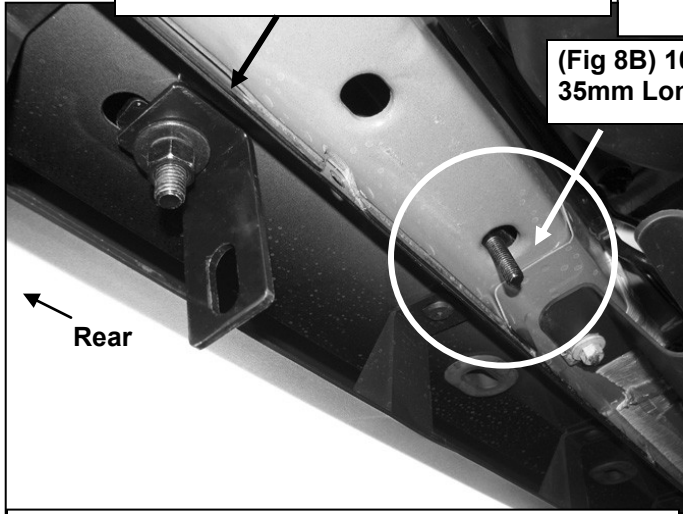

(Fig 8B) 10mm x 35mm Long Bolt

Rear

(Fig 8A) Driver side rear Mounting Bracket location

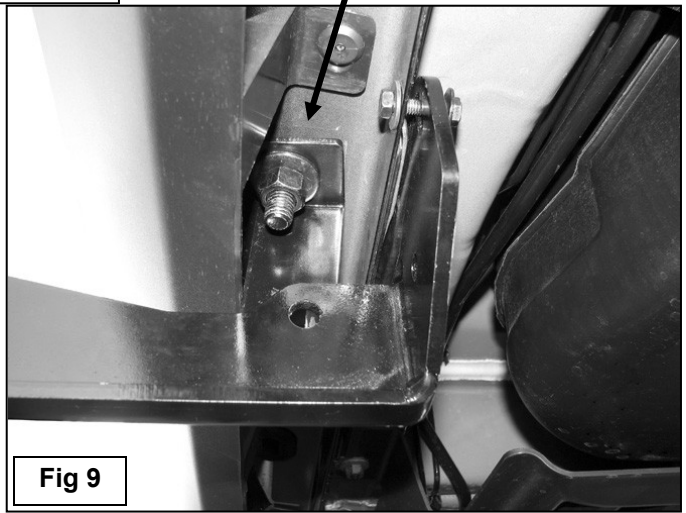

Fig 9

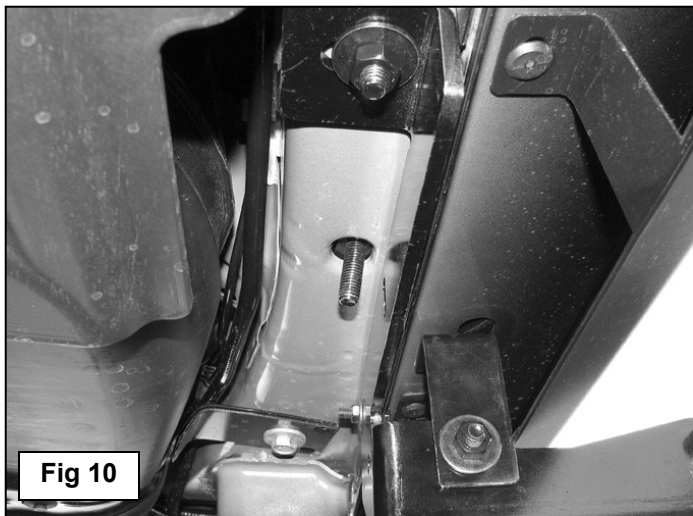

Fig 10

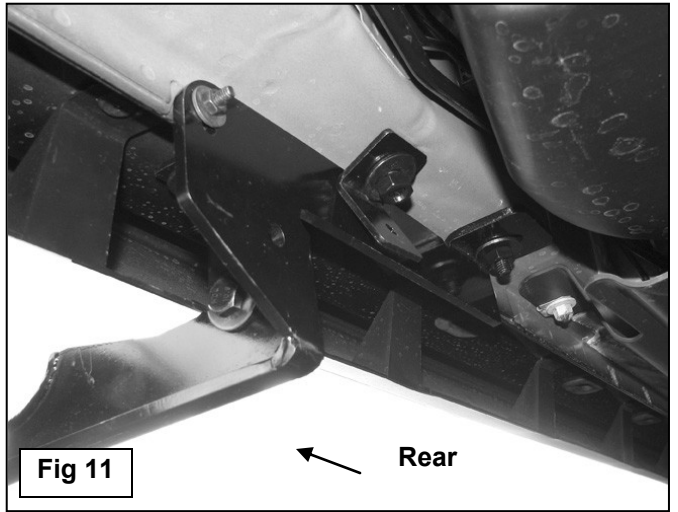

Fig 11

Rear

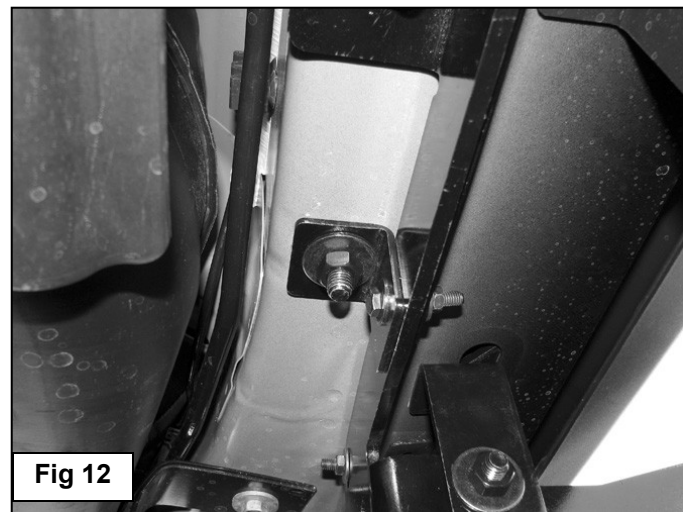

Fig 12

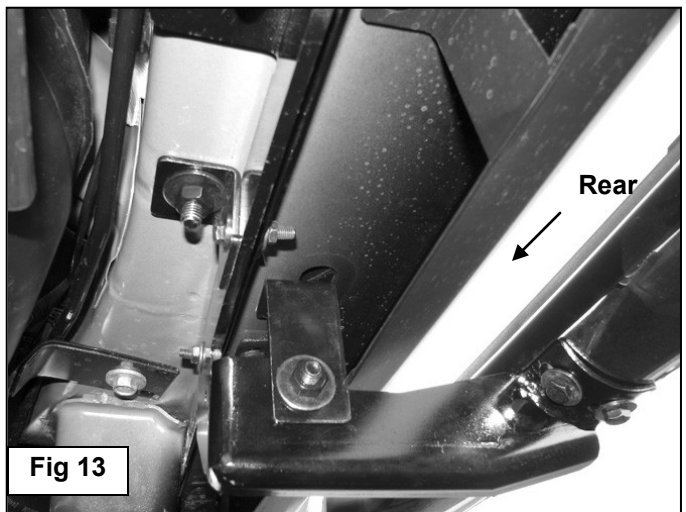

Fig 13

Rear