

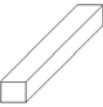

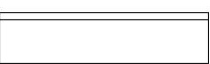







Instruction / Parts Guide "80-TBS-200" Models

This installation should be performed by two people.

View	Qty	Description
	2	2" x 2" x 25" Support Diamond Tread Angle Legs
	4 per drawer	Yellow Drawer Dividers (only for use on Drawer Models)
	2	5/16" x 1 1/4" Hex Cap Bolt
	4	5/16" x 1" Hex Cap Bolt
	2	1/4" Fender Washer
	2	1/4" Lock Washer
	2	1/4" Hex Nut
	2	1/4" 20 x 3" J Bolt
	6	5/16" Nylock Nut
	12	5/16" Flat Washer

Step 1: Balance tool box on bed rail using a support in the bed to steady the box while you are working. Have your helper also hold the box to keep it from rocking.

Step 2: Open lower door or remove lower drawers by pushing down on the right side slide release lever and up on the left side drawer release lever, then pull drawer off and set aside.

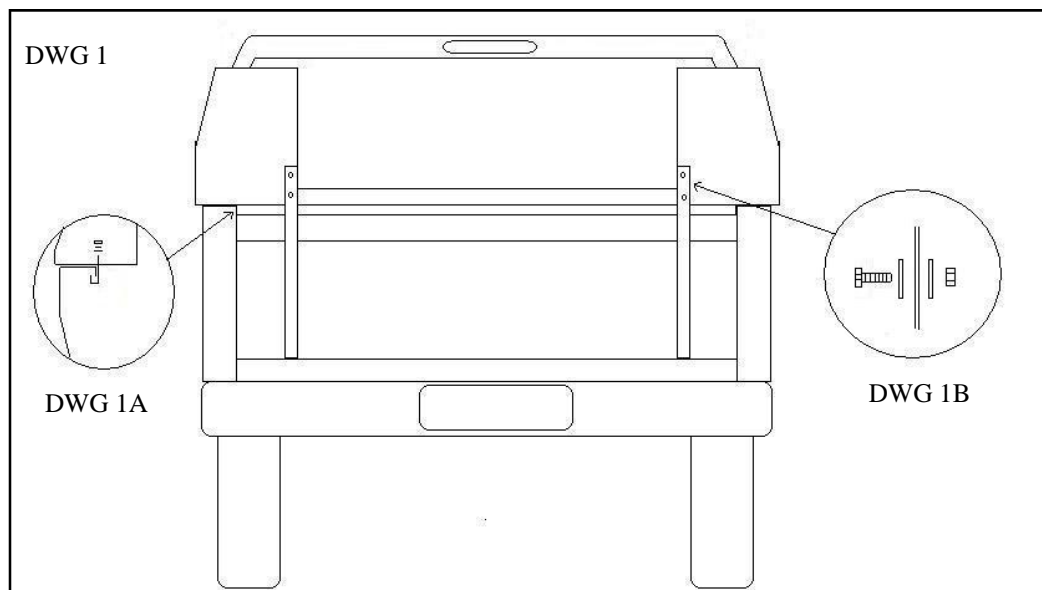

Step 3: On the underside of the tool box and close to the bed rail (rear of truck), drill a 5/16" hole to accept the "J" bolt. Push the "J" bolt thread up into the hole while hooking the bed rail lip. Your helper can then secure it with a fender washer, lock washer and 1/4" hex nut. See DWG 1A. Repeat at the front of the bed rail.

Step 4: Be sure the box is level and install one 2" x 2" x 25" angle leg support at the back inside corner of the box. See DWG 1. You can cut the unwelded end if you need or want to. Drill two 3/8" holes through the legs and into the box then secure with a 5/16" x 1" hex bolt and flat washer, tighten on the inside of the box using a 5/16" flat washer and Nylock nut. See DWG 1B. Repeat at the front of the box.

Step 5: Drill 3/8" hole through the foot of the support leg and through the floor of the truck bed. Before drilling get under the vehicle to be sure no wires or dangerous obstructions are near the area to be drilled. Secure the foot by inserting a 5/16" x 1 1/4" hex bolt and flat washer ; then from under the vehicle install another 5/16" flat washer and secure with a 5/16" Nylock nut.

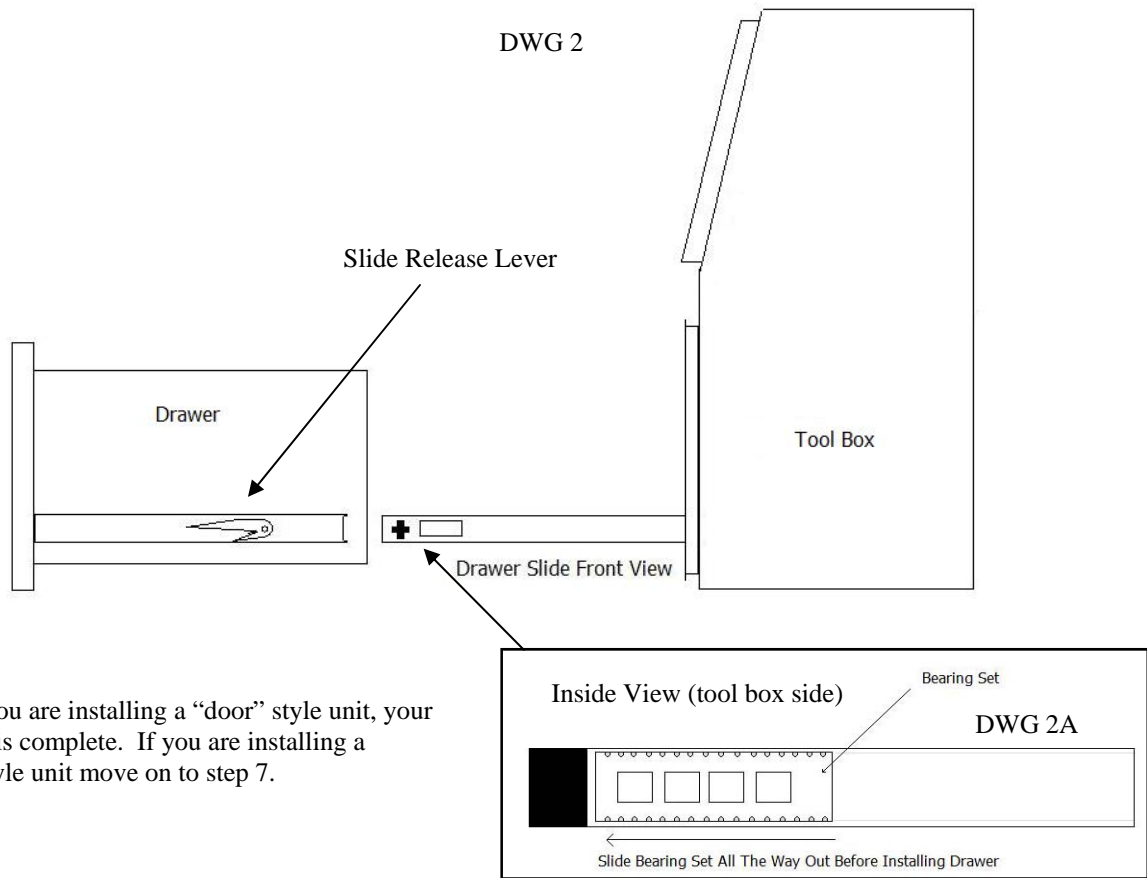

Step 6: If you are installing a "door" style unit, your installation is complete. If you are installing a "drawer" style unit move on to step 7.

Step 7: When installing the drawer first be sure the drawer slide is in full extended position to accept the drawer. See DWG 2. **IMPORTANT:** be sure the bearing set on the drawer slide is also in the full outward position while sliding the drawer into place. Failure to do so will not allow drawer to lock into position.

Once you hear a click sound on both sides of the drawer, you will know the drawer is locked into the slide. Close and latch drawer and your installation is complete.