

# INSTALLATION INSTRUCTIONS

## HDX Bandit Front Bumper



**APPLICATION:**  
2019-2020 Dodge Ram 2500/3500  
**PART NUMBER:**  
58-31195

<b>CONTENT</b>			
<b>ITEM</b>	<b>QUANTITY</b>	<b>DESCRIPTION</b>	<b>TOOLS NEEDED</b>
1	1	HDX BADIT BUMPER	18MM SOCKET
2	2	MOUNTING BRACKET A	18MM WRENCH
3	2	MOUNTING BRACKET B	ALLEN
4	1	MAIN DRIVER BRACKET	TORQUE WRENCH
5	1	MAIN PASSENGER BRACKET	RATCHET
6	1	DRIVER LIGHT COVER (ROUND FOG LIGHTS)	CUTTING TOOL
7	2	PASSENGER LIGHT COVER (ROUND FOG LIGHTS)	21MM SOCKET
8	2	PASSENGER BRACKET (ROUND FOG LIGHTS)	21MM WRENCH
9	2	DRIVER BRACKET (ROUND FOG LIGHTS)	10MM WRENCH
10	6	NYLON SPACER	
11	6	SENSOR PLUG	
12	2	SENSOR L TAB OUTER	
13	4	SENSOR L TAB INNERS	
14	14	M12 HEX HEAD BOLT (YELLOW ZINC)	
15	14	M12 SERRATED FLANGE NUT (YELLOW ZINC)	
16	34	M12 FLAT WASHER (YELLOW ZINC)	
17	24	M12 SPLIT LOCK WASHER (YELLOW ZINC)	
18	10	LONG M12 HEX HEAD BOLT (YELLOW ZINC)	
19	12	M12 HEX NUT (YELLOW ZINC)	
20	12	M6 BUTTON HEAD BOLT (BLACK ZINC)	
21	32	M6 FLAT WASHER (BLACK ZINC)	
22	24	M6 SPLIT LOCK WASHER (BLACK ZINC)	
23	20	M6 HEX NUT (BLACK ZINC)	
24	12	M6 CARRIAGE BOLT (BLACK ZINC)	
25	2	LICENSE PLATE GROMMET	

**ANTI-SEIZE LUBRICANT MUST BE USED ON ALL STAINLESS STEEL FASTENERS TO PREVENT THREAD DAMAGE AND GALLING**



ITEM 1

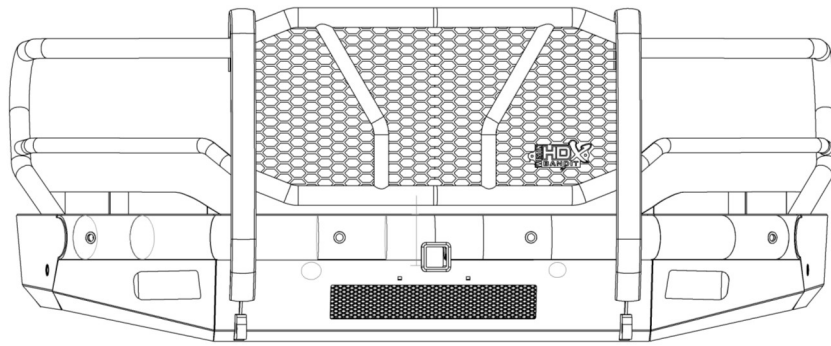

ITEM 2

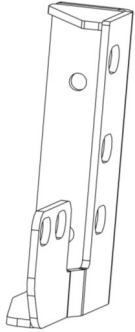

ITEM 3

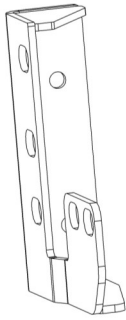

ITEM 4

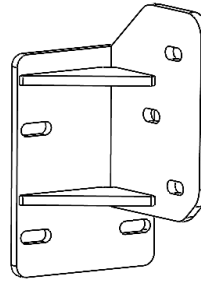

ITEM 6

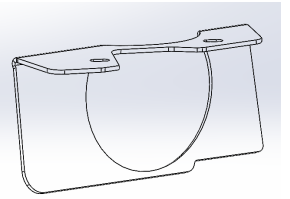

ITEM 9

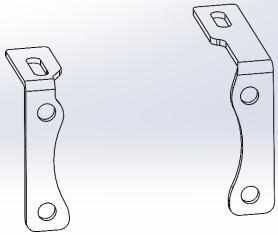

ITEM 11

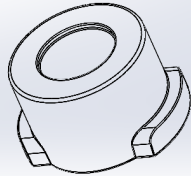

ITEM 12

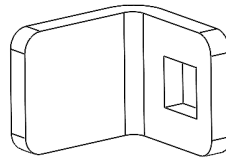

ITEM 13

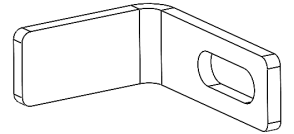

ITEM 10

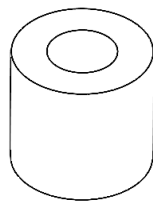

## PROCEDURE

1. Remove contents from box, verify if all parts listed are present and free from damage.  
Carefully read and understand all instructions before attempting installation.

**Failure to identify damage before installation could lead to a rejection of any claim.**

2. Start below the front of the vehicle. Unbolt the two factory bolts (three if tow hooks are equipped) from the bumper bracket on each side. **See Figure 1**

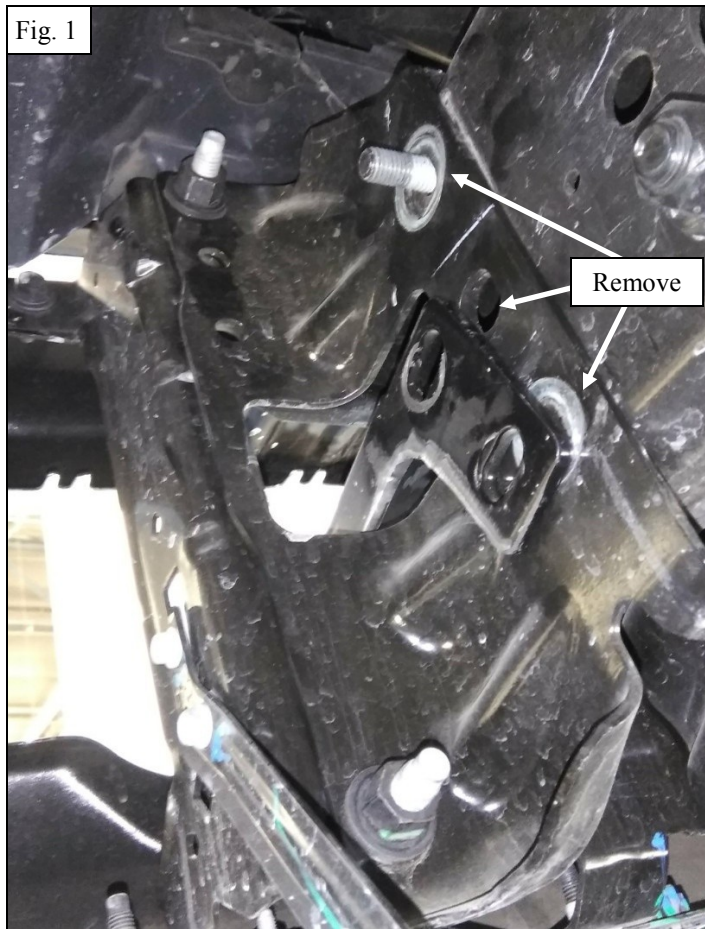

3. Unplug any lights or wiring and remove the bumper.

## PARKING SENSOR INSTALLATION

**\*If not installing sensors, install Hole Plugs into holes on bumper and proceed**

4. Remove the parking sensors from the OEM bumper.
5. Use the Sensor Tab (6) along with the supplied M6 Hardware (26, 27) to install the sensors as shown in **Figure 4**.
6. Make sure to maintain stock sensor orientation.
7. Handle sensors with care as they are fragile.

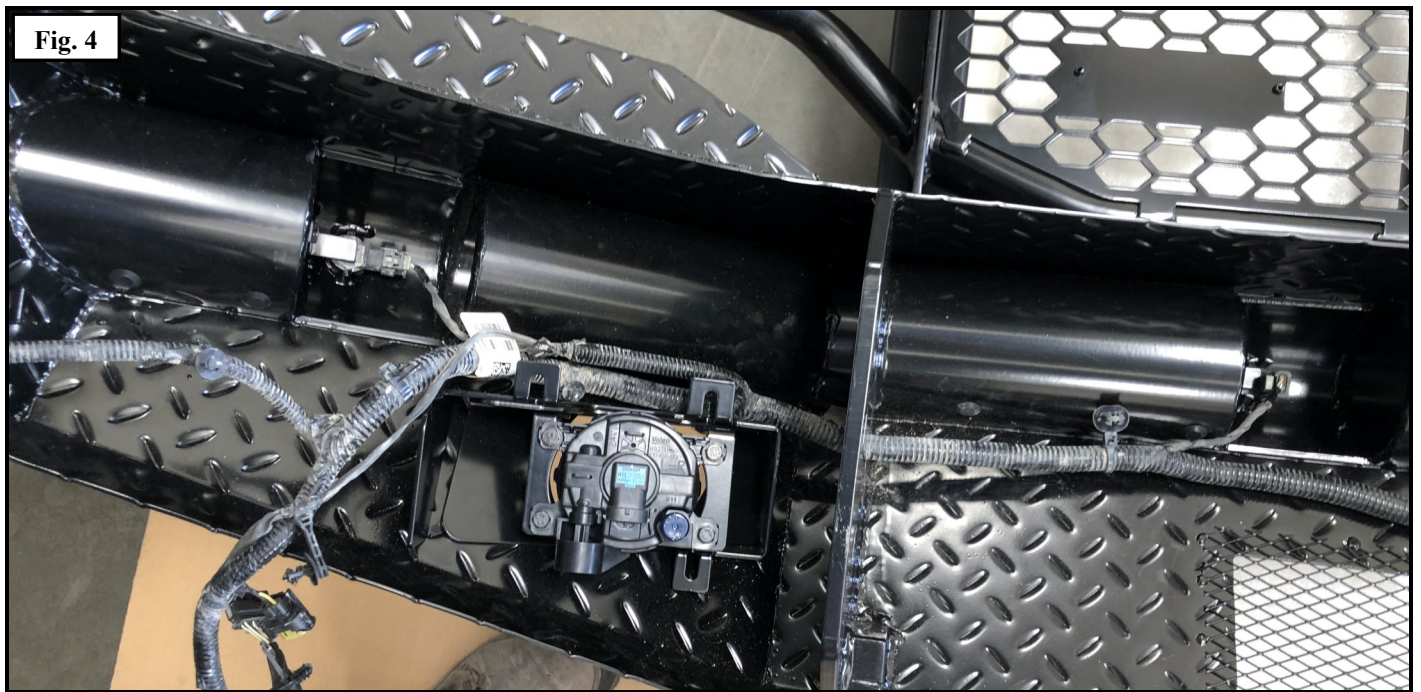
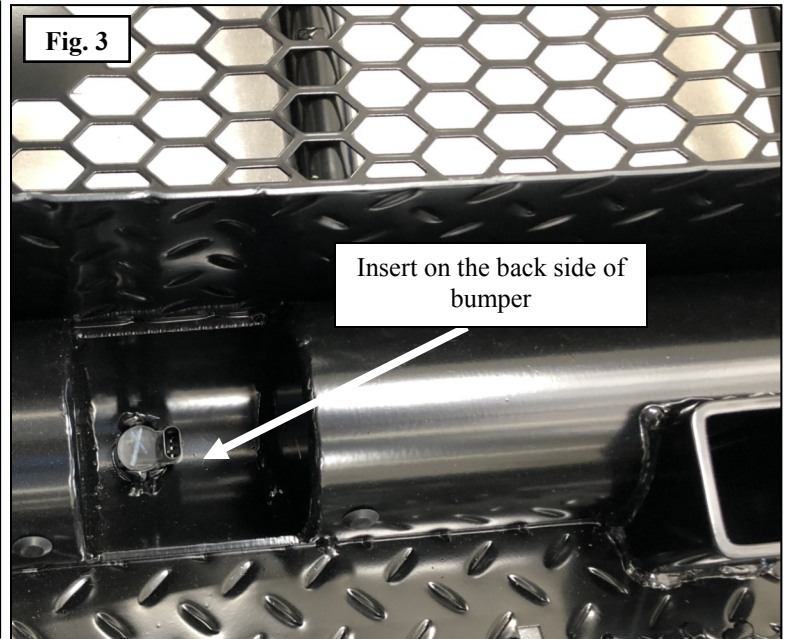
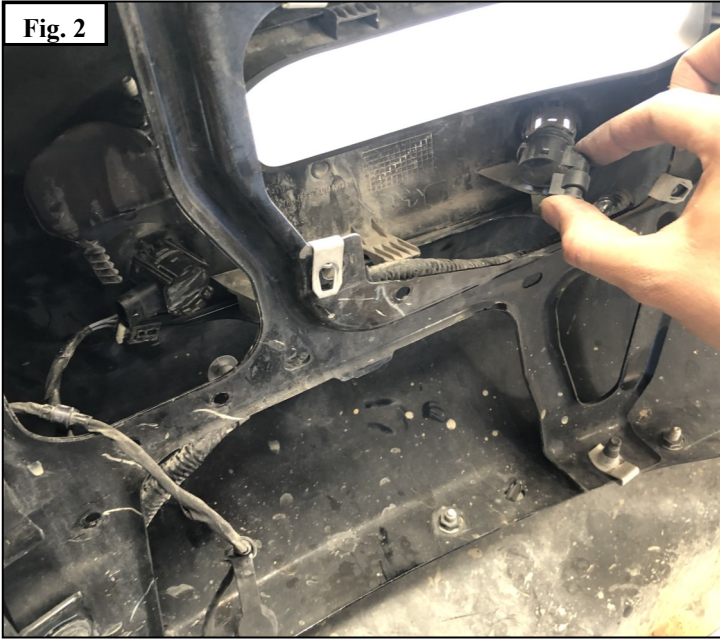

8. You have the option to mount two different styles of fog lights: round or long style (see below).

**Round lights:** Both brackets are supplied to install the round headlights. Insert the light first and then install the brackets using supplied M6 hardware.

**Long lights:** You will not use the supplied brackets. Instead use the nylon spacers on M6 button head bolts for the long style fog light.

Round Light

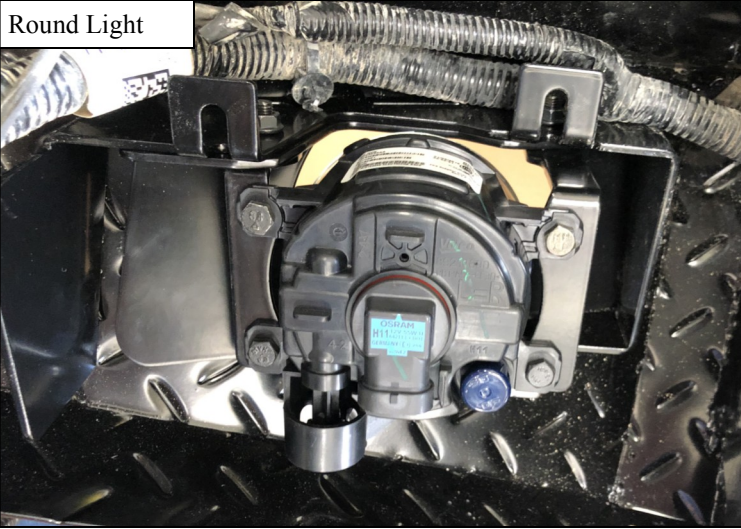

Long Light

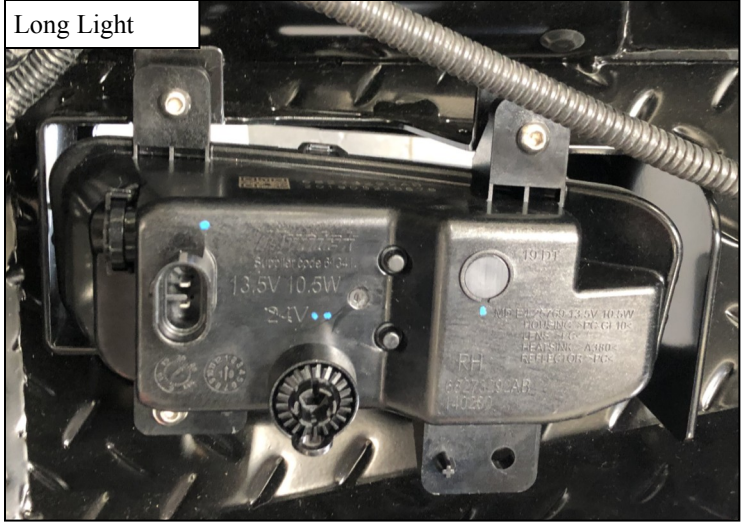

Round Light

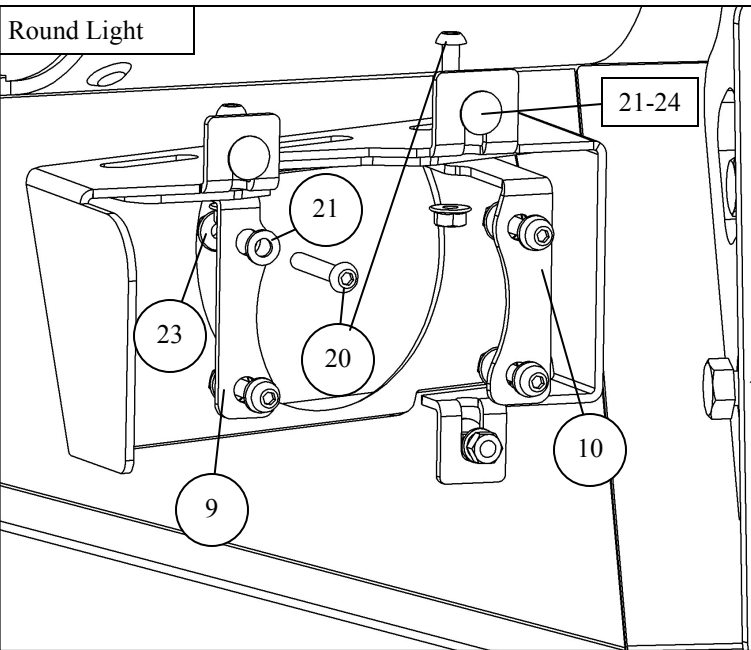

Long Light

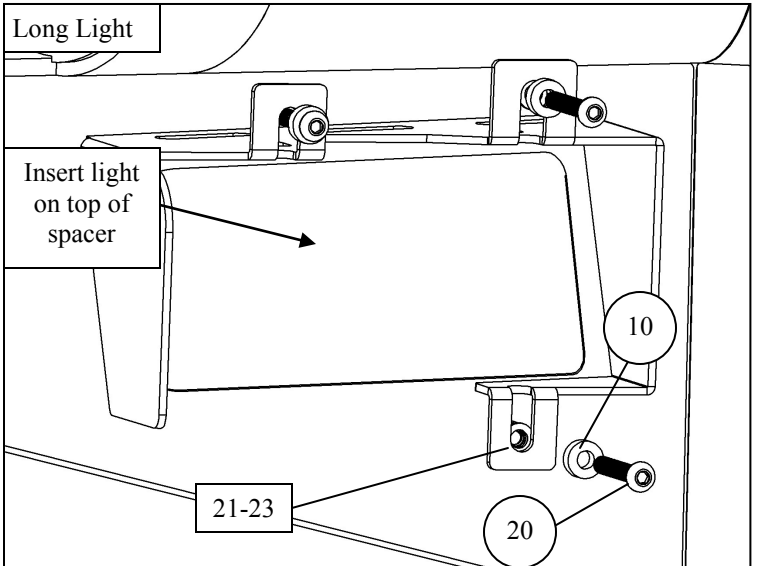

9. Using supplied M12 hardware, loosely assemble bracket A and B to the main frame bracket for each side. See Figure 5.

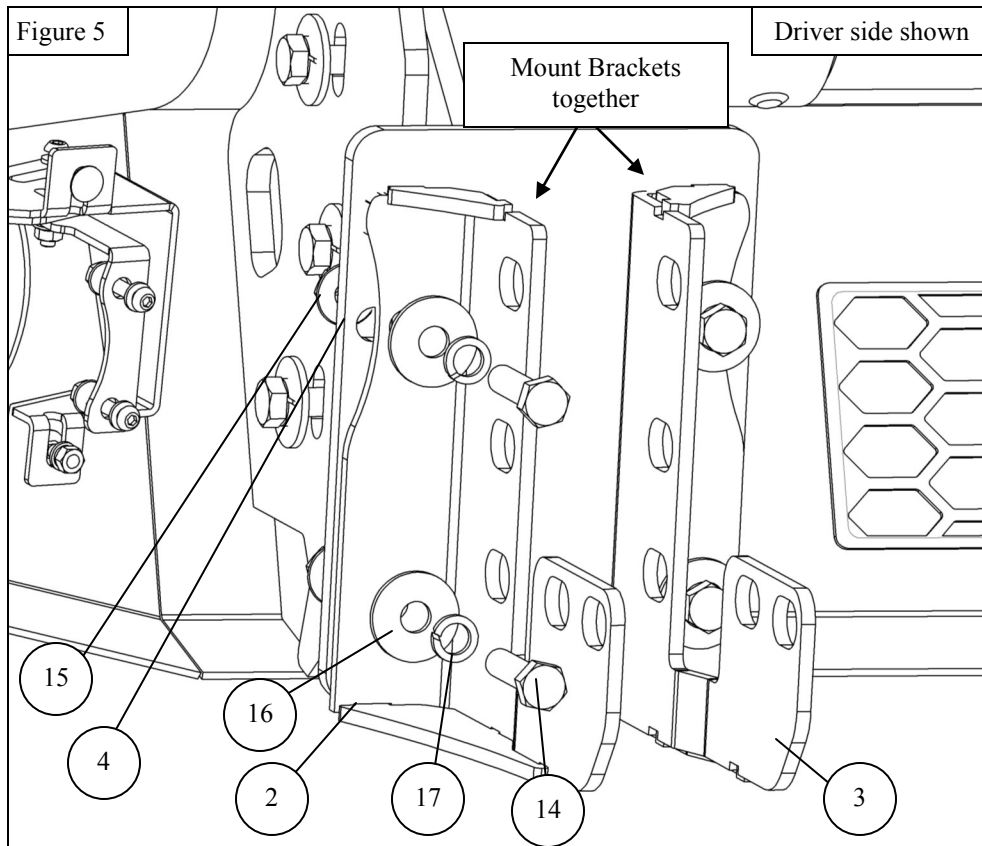

10. Mount the bracket assembly to the frame using the supplied M12 Hardware. See Figure 6-7

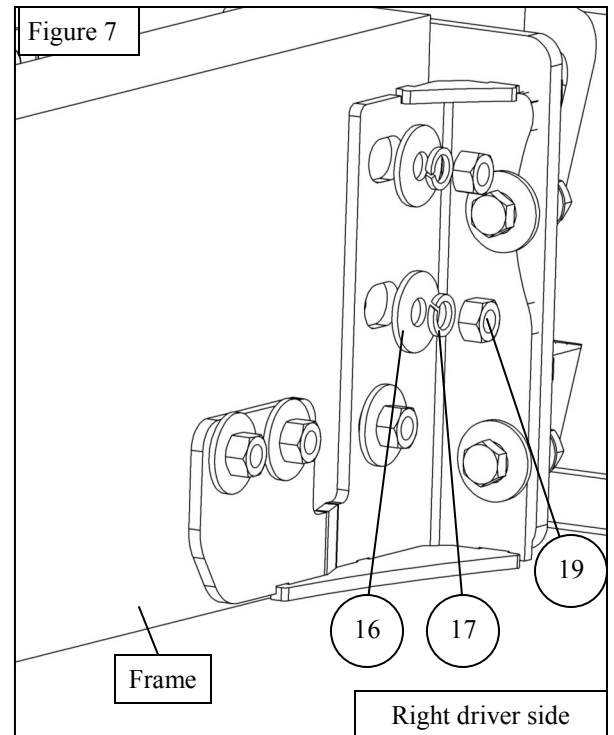
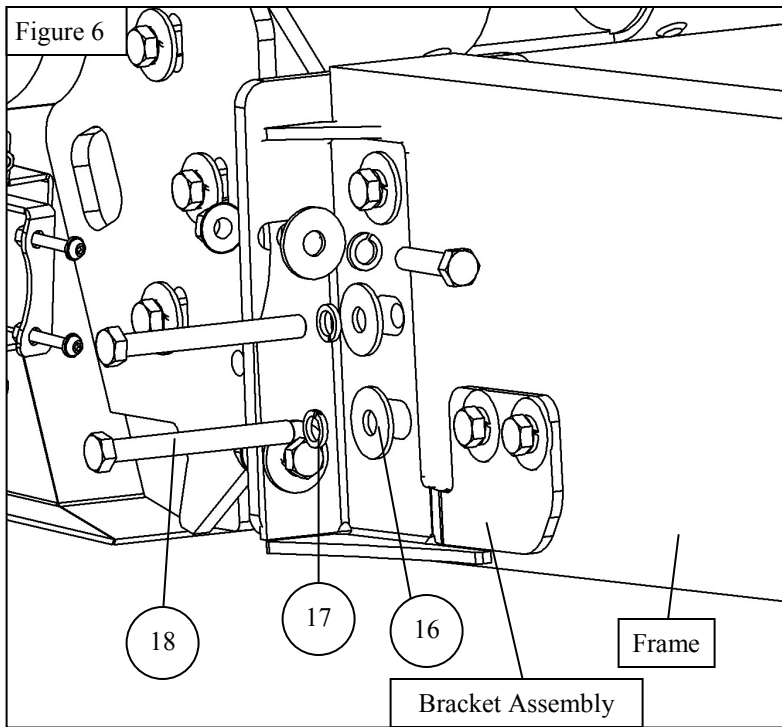

**WARNING: THE BANDIT FRONT BUMPER IS EXTREMELY HEAVY! A LIFT DEVICE MUST BE USED TO HOLD IT IN PLACE WHILE ASSEMBLING.**

11. Lift the bumper up to the bracket assemblies on the truck.

12. Bolt the bracket assemblies to the bumper as shown in **Figure 8** using supplied M12 hardware. Repeat on passenger side.

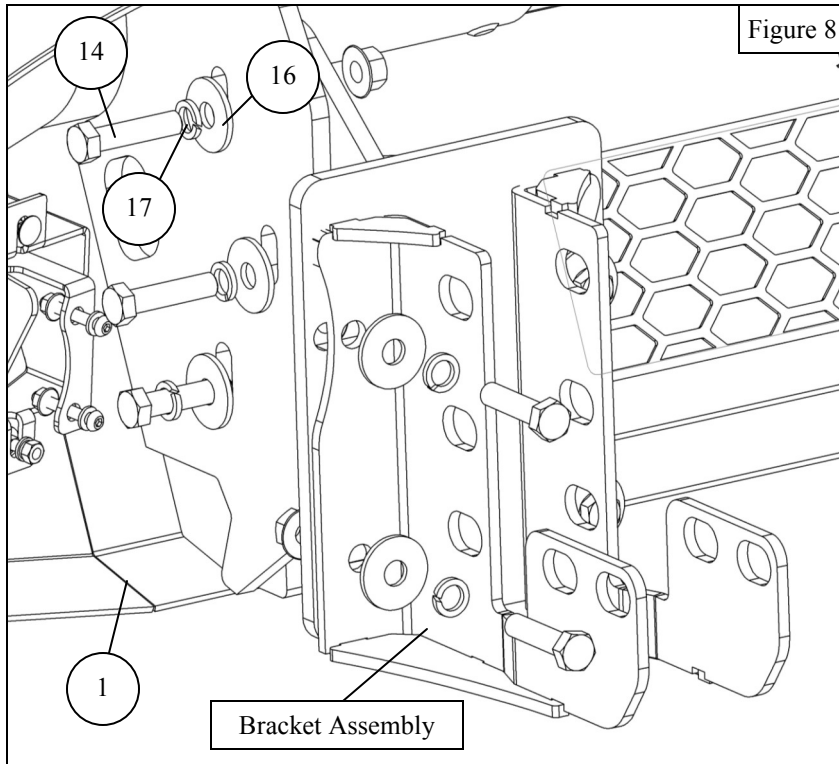

13. Re-attach your license plate using the supplied grommets.

14. Adjust bumper as needed and torque all M12 hardware to 60 ft-lbs.

INSTALLATION COMPLETE



CARE INSTRUCTIONS

- REGULAR WAXING IS RECOMMENDED. DO NOT USE ANY TYPE OF POLISH OR WAX THAT MAY CONTAIN ABRASIVES.
- STAINLESS STEEL PRODUCTS CAN BE CLEANED WITH MILD SOAP AND WATER. STAINLESS STEEL POLISH SHOULD BE USED TO POLISH SMALL SCRATCHES.
- GLOSS BLACK FINISHES SHOULD BE CLEANED WITH MILD SOAP AND WATER.





## WARNING



Failure to follow these instructions could lead to death, personal injury, and / or property damage.

Failure to follow these instructions could lead to death, personal injury, and / or property damage.

### FASTENERS:

All Westin supplied fasteners must be utilized and installed in accordance with the installation instructions and apply torque to the specifications as defined. **DOUBLE CHECK ALL FASTENERS BEFORE INITIAL USE, AND PERIODICALLY IN THE FUTURE TO ENSURE PROPER FUNCTION AND SAFETY.**

### DRILLING:

Most Westin products do not require drilling for installation. If drilling is defined as required, use caution when drilling a vehicle. **FAILURE TO REVIEW AN AREA TO BE DRILLED MAY RESULT IN PERSONAL INJURY AND/OR INJURY TO OTHERS AS WELL AS VEHICLE DAMAGE.**

### EYE PROTECTION:

**ALWAYS WEAR SAFETY GLASSES OR GOGGLES DURING THE INSTALLATION PROCESS TO AVOID PERSONAL INJURY.**

### MAXIMUM TOWING/CARRYING CAPACITY: (if applicable)

The Westin Receiver Hitches will have a visible tow rating label affixed directly on the product. User should never exceed the vehicle manufacturers maximum tow and weight rating regardless of the capacity of the hitch. **FAILURE TO FOLLOW THESE GUIDELINES WILL VOID THE WESTIN WARRANTY AND MAY RESULT IN PERSONAL INJURY AND/OR INJURY TO OTHERS AS WELL AS VEHICLE DAMAGE.**

### FOR CALIFORNIA RESIDENTS ONLY-PROP 65 WARNING:

Some products may contain chemicals such as DEHP, which can cause cancer, birth defects or other reproductive harm.



Learn more about off-road bumpers we have.