

# INSTALLATION INSTRUCTIONS

## HLR TRUCK RACK



**APPLICATION:**  
2017-2018 Ford Super Duty  
**PART NUMBER:**  
57-81055

<b>CONTENT</b>			
<b>ITEM</b>	<b>QUANTITY</b>	<b>DESCRIPTION</b>	<b>TOOLS NEEDED</b>
1	1	Hoop/Screen Assembly	10 mm Wrench
2	1	Mounting Bracket (Driver's Side)	10 mm Socket
3	1	Mounting Bracket (Passenger's Side)	1/4" Drive Ratchet
4	2	M12 Bolt Plate	19mm Wrench
5	4	M8 Hex Head Bolt Long	13mm Wrench
6	4	M8 Hex Nut Nylock	13mm Socket
7	8	M8 Flat Washer Large	
8	2	M12 Hex Nut	
9	2	M12 Lock Washer	
10	2	M12 Flat Washer	
11	2	M12 Fish Wire	
12	2	M12 Plastic Retainers	
13	4	M8 Hex Head Bolt Short	
14	4	M8 Flat Washer Small	
15	4	M8 Split Lock Washer	

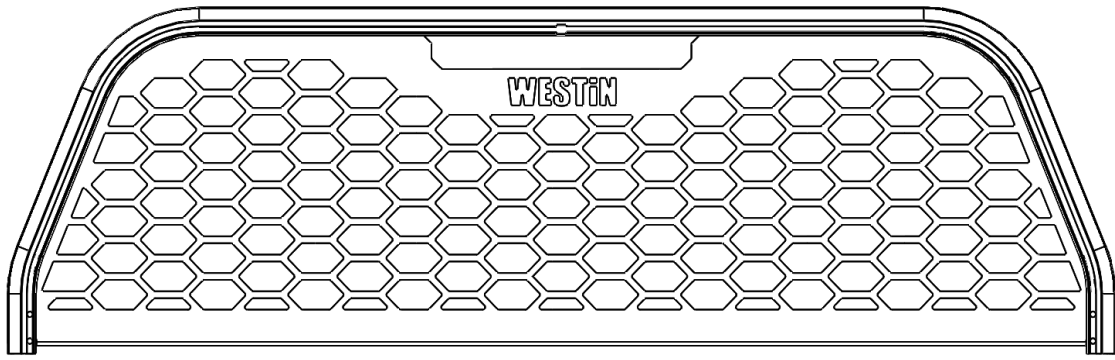

ITEM 1

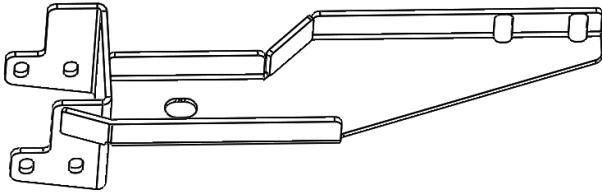

ITEM 2

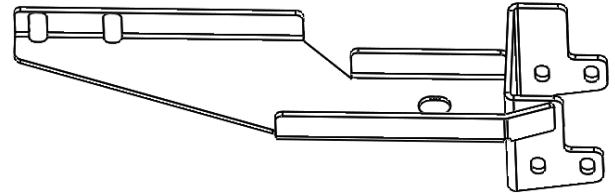

ITEM 3

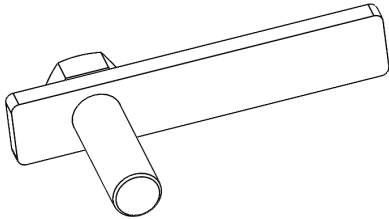

ITEM 4

### PROCEDURE

1. Remove contents from box, verify if all parts listed are present and free from damage.  
Carefully read and understand all instructions before attempting installation.  
**Failure to identify damage before installation could lead to a rejection of any claim.**

2. Insert short M12 bolt plate into side hole of the bed through the stake pocket. Thread one of the supplied M12 plastic retainers on to bolt plate to keep it from falling into the hole. See **Figure 1**.
3. Remove the front factory cargo hook from the bed. See **Figure 2**.
4. Locate mounting bracket **Item 2** and insert hardware according to **Figure 3**.
5. Hand tighten hardware only for now. All hardware will be fully tightened at the end of installation.



Figure 1



Figure 2

Remove

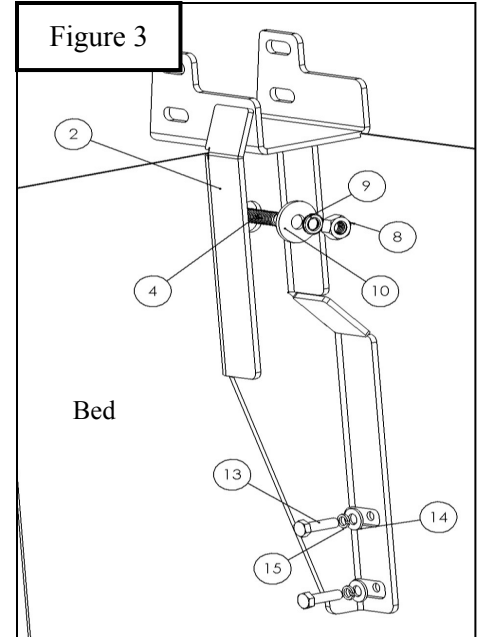

Figure 3

Bed

Driver's Side Shown

6. Repeat steps 2-6 on passenger's side.
7. Position Hoop/Screen Assembly **Item 1** on bracket cradles according to **Figure 4**.

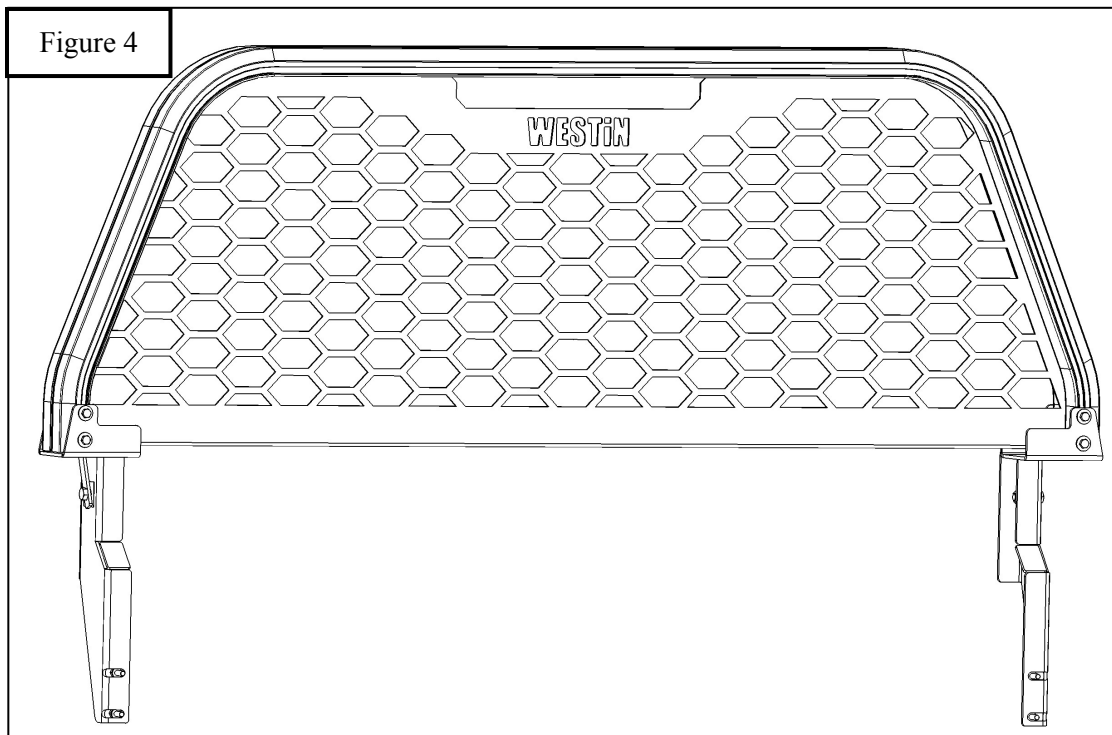
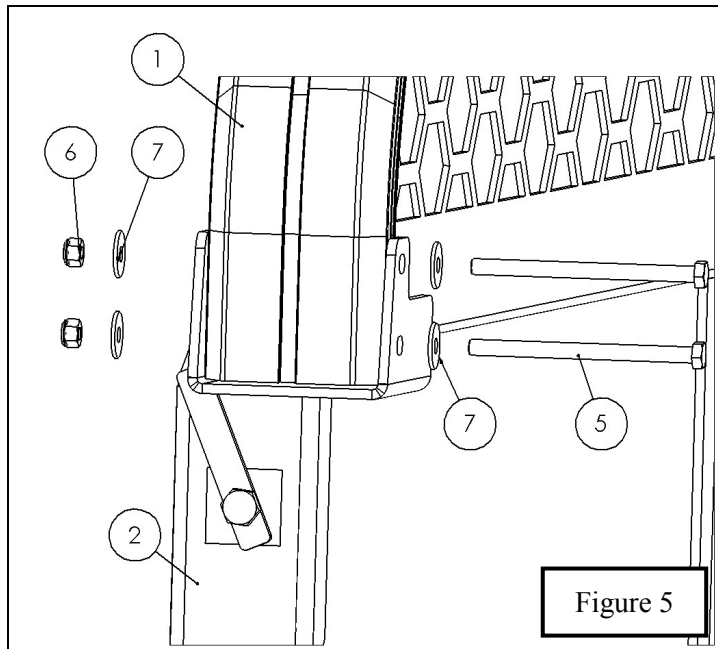

Figure 4

9. Using supplied M8 hardware, fasten **Item 1** on to brackets. See **Figure 5**.  
Tighten all M8 hardware to 15-18 ft-lbs and all M12 hardware to 50-55 ft-lbs.



**INSTALLATION COMPLETE**



**WESTIN**



## WARNING



Failure to follow these instructions could lead to death, personal injury, and / or property damage.

Failure to follow these instructions could lead to death, personal injury, and / or property damage.

### FASTENERS:

All Westin supplied fasteners must be utilized and installed in accordance with the installation instructions and apply torque to the specifications as defined. **DOUBLE CHECK ALL FASTENERS BEFORE INITIAL USE, AND PERIODICALLY IN THE FUTURE TO ENSURE PROPER FUNCTION AND SAFETY.**

### DRILLING:

Most Westin products do not require drilling for installation. If drilling is defined as required, use caution when drilling a vehicle. **FAILURE TO REVIEW AN AREA TO BE DRILLED MAY RESULT IN PERSONAL INJURY AND/OR INJURY TO OTHERS AS WELL AS VEHICLE DAMAGE.**

### EYE PROTECTION:

**ALWAYS WEAR SAFETY GLASSES OR GOGGLES DURING THE INSTALLATION PROCESS TO AVOID PERSONAL INJURY.**

### MAXIMUM TOWING/CARRYING CAPACITY:

The Westin Receiver Hitches will have a visible tow rating label affixed directly on the product. User should never exceed the vehicle manufacturers maximum tow and weight rating regardless of the capacity of the hitch. **FAILURE TO FOLLOW THESE GUIDELINES WILL VOID THE WESTIN WARRANTY AND MAY RESULT IN PERSONAL INJURY AND/OR INJURY TO OTHERS AS WELL AS VEHICLE DAMAGE.**