

INSTALLATION INSTRUCTIONS

HLR Truck Rack



APPLICATION:
2009-2018 Ram 1500/2500/3500
PART NUMBER:
57-81025

CONTENT

ITEM	QUANTITY	DESCRIPTION	TOOLS NEEDED
1	1	Hoop/Screen Assembly	19mm Wrench
2	1	Mounting Bracket (Driver's Side)	Torque Wrench
3	1	Mounting Bracket (Passenger's Side)	1/2" Drive Ratchet
4	2	M12 Bolt Plate Long	13mm Socket
5	2	M12 Bolt Plate Short	13mm Wrench
6	8	M8 Flat Washer	
7	4	M8 Hex Nut Nylock	
8	4	M8 Hex Head Bolt	
9	4	M12 Hex Nut	
10	4	M12 Split Lock Washer	
11	4	M12 Fish Wire	
12	4	M12 Plastic Retainers	
13	2	M12 Flat Washer Large	
14	2	M12 Flat Washer Small	



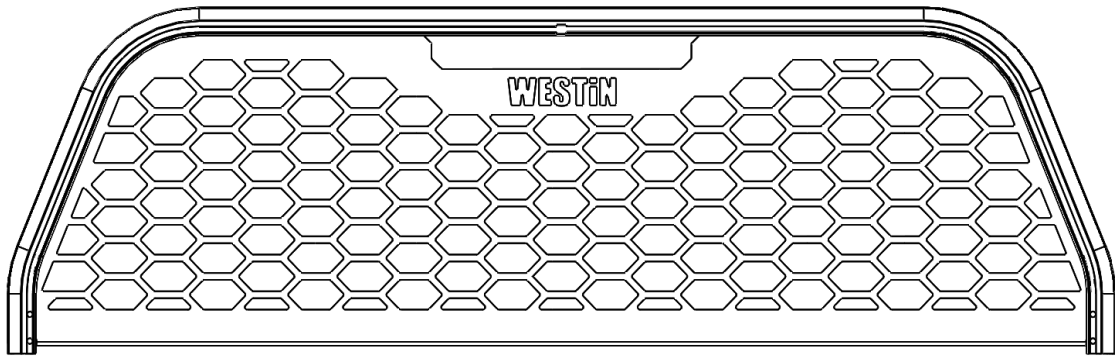

ITEM 1

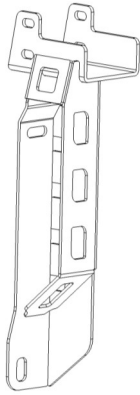

ITEM 2

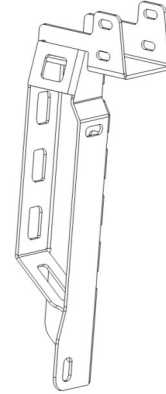

ITEM 3

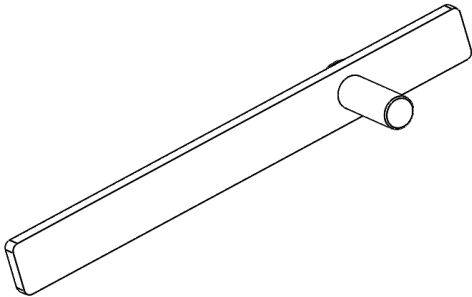

ITEM 4

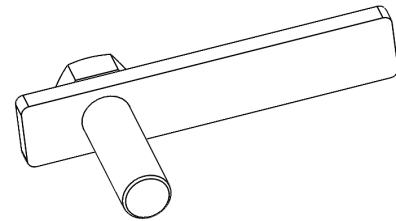

ITEM 5

PROCEDURE

1. Remove contents from box, verify if all parts listed are present and free from damage.
Carefully read and understand all instructions before attempting installation.
Failure to identify damage before installation could lead to a rejection of any claim.

2. Insert short M12 bolt plate into side hole of the bed through the stake pocket. Thread one of the supplied M12 plastic retainers on to bolt plate to keep it from falling into the hole. See **Figure 1**.
3. Thread an M12 Fish Wire onto the Long M12 Bolt Plate and insert it through the bottom of the wheel well into the hole in **Figure 1**. See **Figure 2** for fish wire location.
4. Locate the Mounting Bracket and insert hardware according to **Figure 3**.

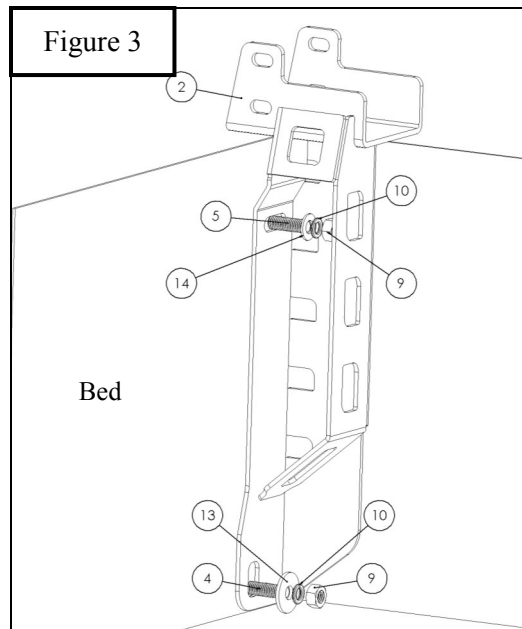
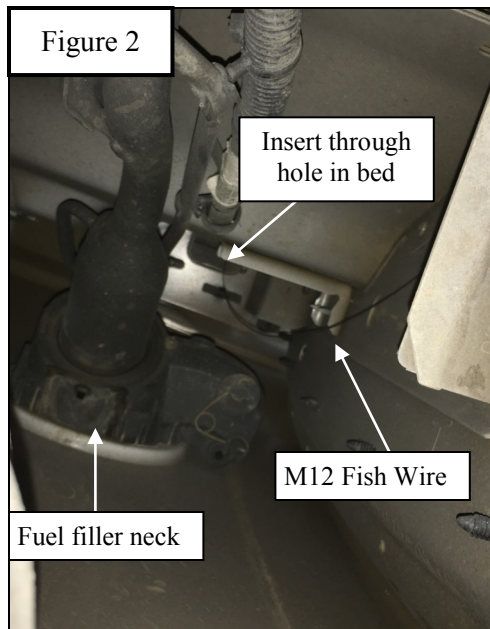

5. Repeat Steps 2-4 on Passenger's Side.
6. Position the Hoop/Screen Assembly into the Mounting Brackets as shown in **Figure 4**.

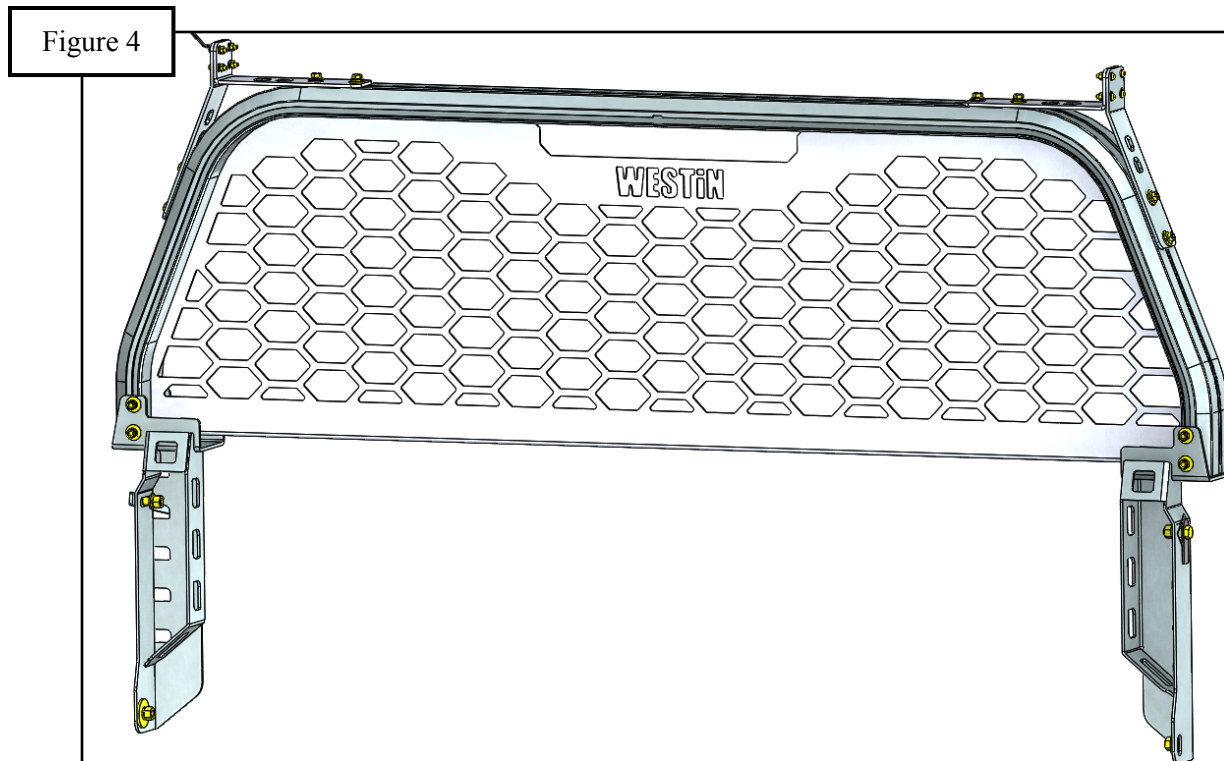

7. Using supplied M8 hardware, fasten **Item 1** on to brackets. See **Figure 5**.

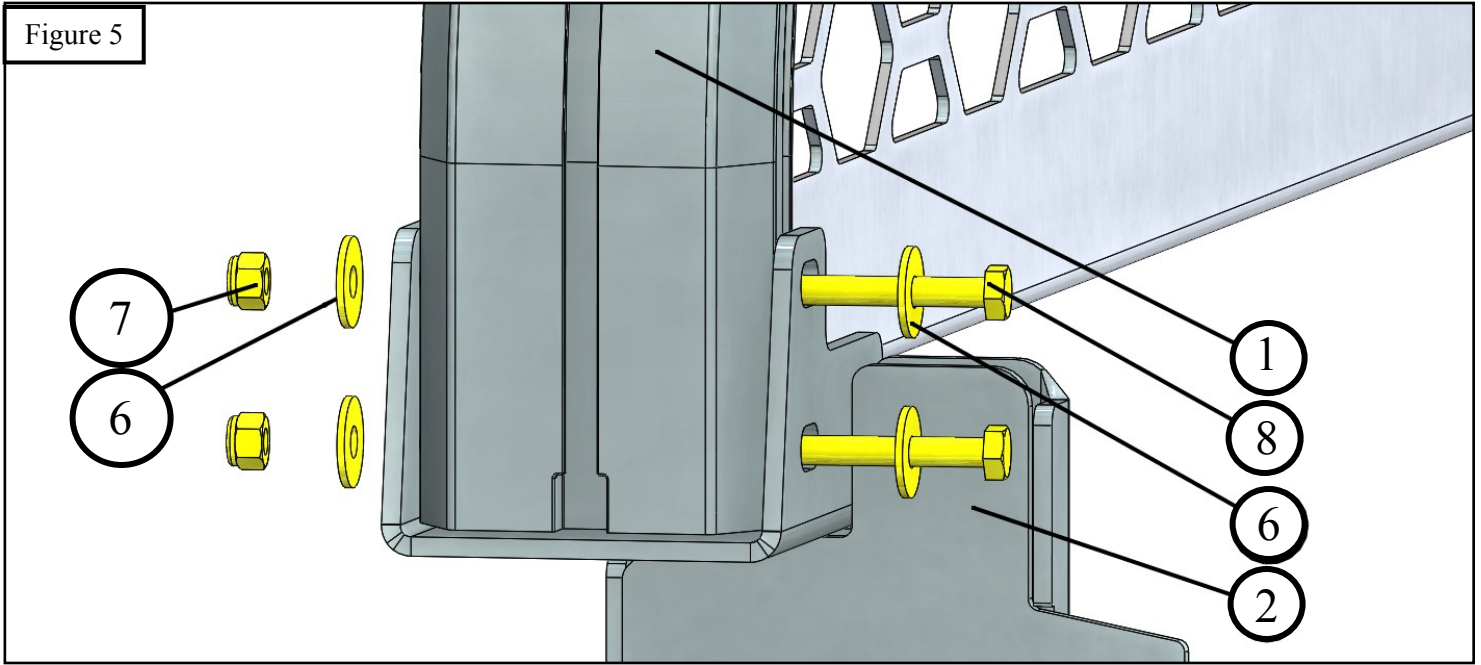

8. Once all components are positioned as desired. Tighten all M8 hardware to 15-18 ft-lbs and all M12 to 50-55 ft-lbs.
Note: When tightening M8 hardware that was used to install hoop and screen assembly on step 7, push the top of the HLR rack towards the cab of the truck to maintain straight while tightening.

Installation Complete



WESTIN



WARNING



Failure to follow these instructions could lead to death, personal injury, and / or property damage.

Failure to follow these instructions could lead to death, personal injury, and / or property damage.

FASTENERS:

All Westin supplied fasteners must be utilized and installed in accordance with the installation instructions and apply torque to the specifications as defined. **DOUBLE CHECK ALL FASTENERS BEFORE INITIAL USE, AND PERIODICALLY IN THE FUTURE TO ENSURE PROPER FUNCTION AND SAFETY.**

DRILLING:

Most Westin products do not require drilling for installation. If drilling is defined as required, use caution when drilling a vehicle. **FAILURE TO REVIEW AN AREA TO BE DRILLED MAY RESULT IN PERSONAL INJURY AND/OR INJURY TO OTHERS AS WELL AS VEHICLE DAMAGE.**

EYE PROTECTION:

ALWAYS WEAR SAFETY GLASSES OR GOGGLES DURING THE INSTALLATION PROCESS TO AVOID PERSONAL INJURY.

MAXIMUM TOWING/CARRYING CAPACITY:

The Westin Receiver Hitches will have a visible tow rating label affixed directly on the product. User should never exceed the vehicle manufacturers maximum tow and weight rating regardless of the capacity of the hitch. **FAILURE TO FOLLOW THESE GUIDELINES WILL VOID THE WESTIN WARRANTY AND MAY RESULT IN PERSONAL INJURY AND/OR INJURY TO OTHERS AS WELL AS VEHICLE DAMAGE.**

