



# INSTRUCTIONS

APPLICATION: CHEVY SILVERADO 1500 HDX & SPORTSMAN GRILLE GUARDS  
(2014 & UP) APPLICATION PART #'S 57-3680, 57-3685, 40-3685, 45-3680

AUTOMOTIVE PRODUCTS, INC.

ITEM	QUANTITY	DESCRIPTION	TOOLS NEEDED
1	1	GRILLE GUARD ASSEMBLY	RATCHET
2,3	2	LOWER MOUNTING BRACKETS (DRV & PASS)	SCREWDRIVER
4,5	2	LOWER SUPPORT BRACKETS (DRV & PASS)	15MM WRENCH
6,7	2	UPPER SUPPORT BRACKETS (DRV & PASS)	15MM SOCKET
8	2	M12 NUTPLATE (YELLOW ZINC)	ALLEN WRENCH
9	2	M12 STUD (YELLOW ZINC)	18MM WRENCH
10	2	M12 THICK WASHER (YELLOW ZINC)	18MM SOCKET
11	2	M12 WIDE WASHER (YELLOW ZINC)	10MM SOCKET
12	2	M12 LOCK WASHER (YELLOW ZINC)	7MM SOCKET
13	2	M12 HEX NUT (YELLOW ZINC)	16MM SOCKET
14	2	M12 POLY BOLT RETAINER	16MM WRENCH
15	8	M12 HEX HEAD BOLT (STAINLESS)	RATCHET EXT.
16	8	M12 LOCK WASHER (STAINLESS)	TORQUE WRENCH
17	16	M12 FLAT WASHER (STAINLESS)	UTILITY KNIFE
18	8	M12 HEX NUT (STAINLESS)	
19	2	M10 BUTTON HEAD BOLT (STAINLESS)	
20	4	M10 FLAT WASHER (STAINLESS)	
21	2	M10 LOCK WASHER (STAINLESS)	
22	2	M10 HEX NUT (STAINLESS)	

**ANTI-SEIZE LUBRICANT MUST BE USED ON ALL STAINLESS STEEL FASTENERS TO PREVENT THREAD DAMAGE AND GALLING**

1. Remove contents from box, verify if all parts listed are present and free from damage. Carefully read and understand all instructions before attempting installation.
2. Remove the front grille and filler panel from the front of the vehicle (Figures 1 - 6).



Fig. 1

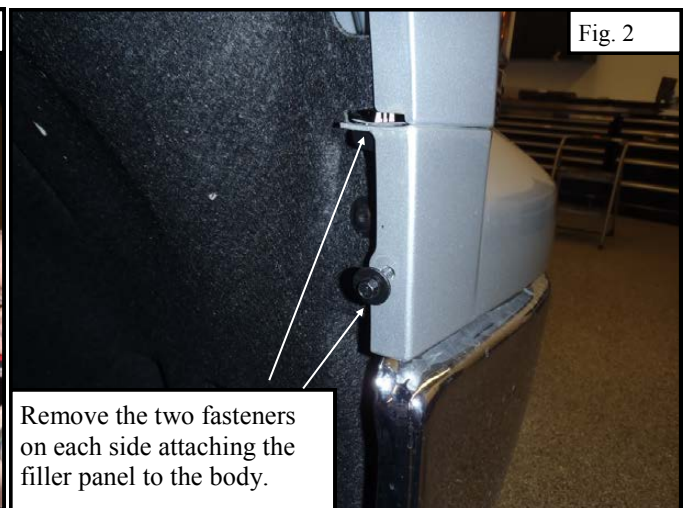

Fig. 2



Thank You for choosing Westin products.

Working from beneath the vehicle use a flathead screwdriver to pop loose the plastic tabs retaining the filler panel to the grille.

Fig. 3

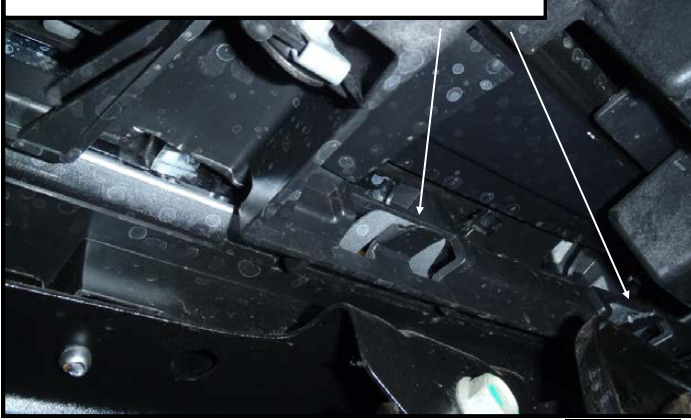

Once all fasteners have been removed and the tabs are popped loose carefully pull the filler panel off of the vehicle.

Fig. 4

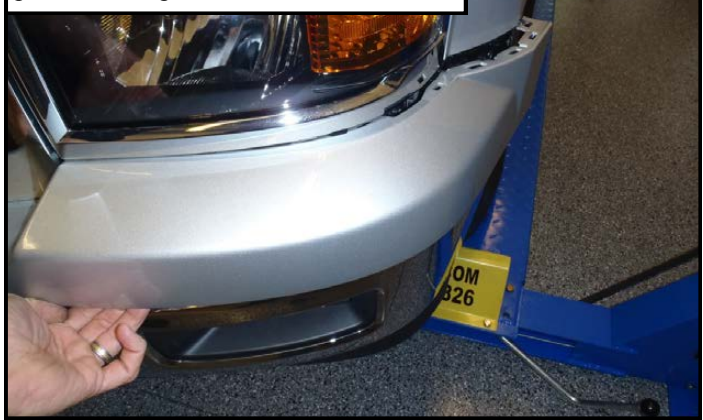

Remove all of the lower screws holding the grille to the radiator support.

Fig. 5



Fig. 6

Remove all of upper the screws holding the grille to the upper radiator support and carefully pull it from the vehicle. Note: there are several inaccessible clips that provide some retention on the grille. They will pop loose when you pull on the grille.

3. Starting on the Driver Side remove the M12 bumper bolt and loosely install the Driver Side upper support strap (Figure 7).
4. Repeat step 3 for the Passenger Side.
5. Measure from the middle ridge of the bumper face channel to the outer edge of the each support bracket. Adjust the brackets to approximately 20-5/8" (Figure 8). Tighten the brackets to 50—55 ft-lbs.
6. Verify that the distance between the tightened upper support straps is less than or equal to the distance between the upper mount points on the grille guard. These brackets cannot be adjusted once the filler panel has been re-installed.

Install the Upper Support Strap as shown.

Fig. 7



Adjust to 20-5/8" from center of bumper to edge of Upper Support Bracket.

Fig. 8

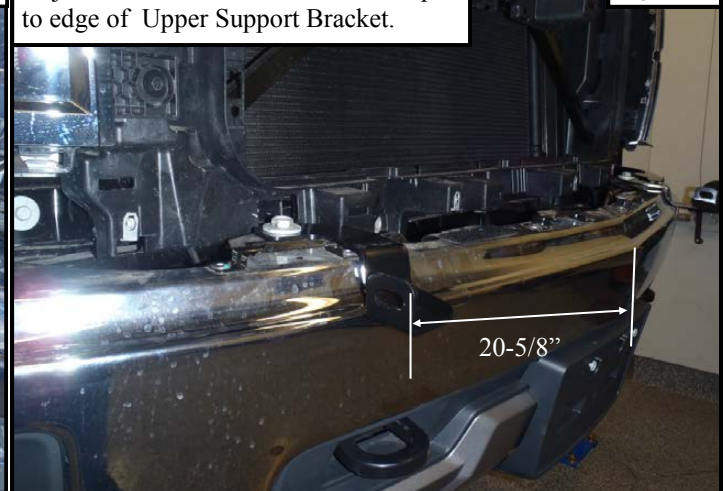

7. Re-install the grille and filler panel in the reverse order that they were removed.
8. From beneath the vehicle slip the supplied M12 nutplates into the large holes in the bottom of the frame as shown (Figure 9). Make sure the flat portion of the nutplate is on the bottom of the frame and center the threaded portion in the middle of the hole.
9. Assemble the thick M12 washer and poly washer on the M12 stud (Figure 10). Partially thread the assembly into the nutplate previously placed inside the frame. The thick washer centers the stud in the middle of the large hole. The poly washer prevents the washer from falling off.

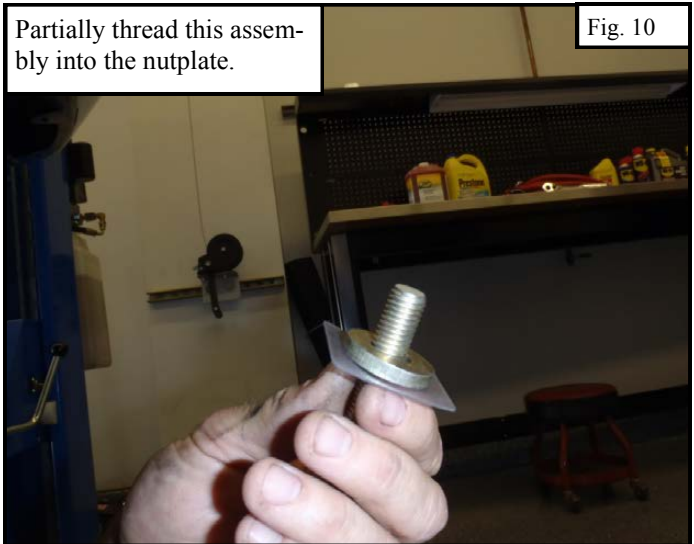

10. Loosely install the Lower Mounting Brackets on the studs using the supplied M12 hardware (Figure 11). Note: The lower plastic valance will either need to be trimmed or permanently removed in order to accomplish this.
11. Remove the lower M10 factory bumper bolts. Re-use them to loosely install the Lower Support Brackets (Figure 12).

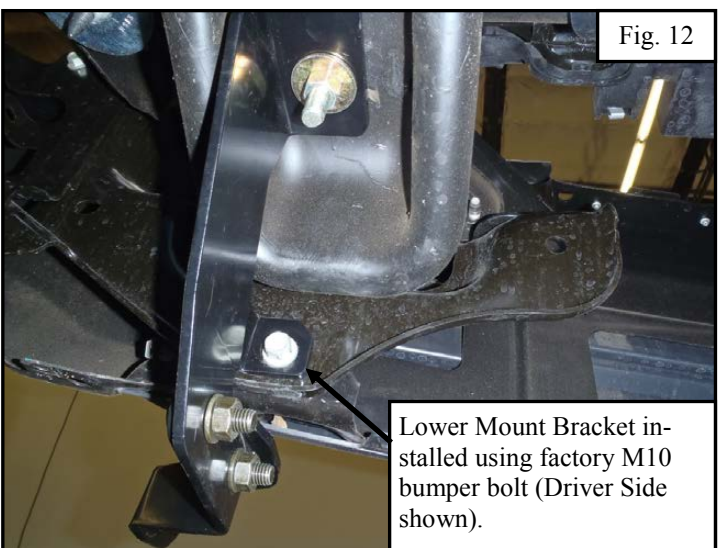
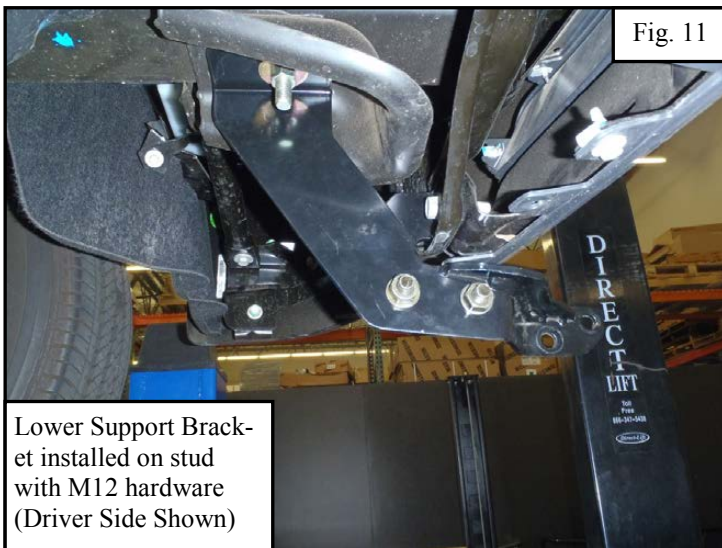

12. Loosely attach the lower support brackets to the lower mount brackets using the supplied M12 hardware.
13. With assistance loosely install the Grille Guard on the lower mounting brackets using the supplied M12 hardware (Figure 13)
14. Loosely bolt the Upper Support Strap to the Grille Guard using the supplied M10 hardware (Figure 14).

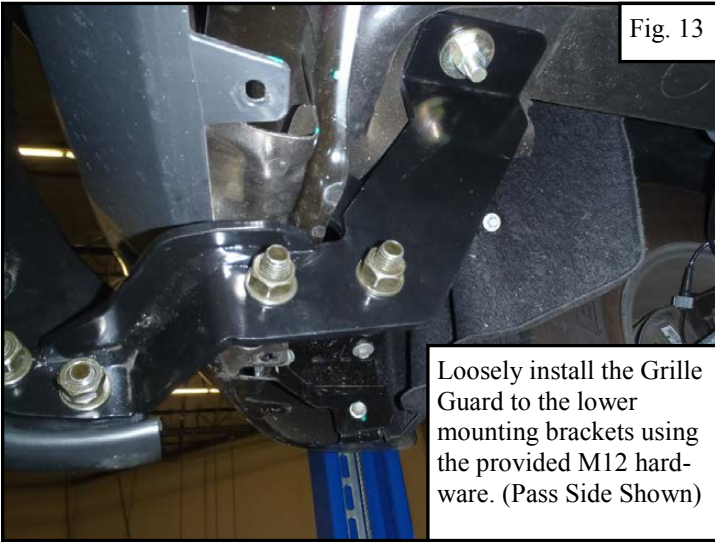

Fig. 13

Loosely install the Grille Guard to the lower mounting brackets using the provided M12 hardware. (Pass Side Shown)



Fig. 14

Loosely attach the Upper Support Strap to the Grille Guard using supplied M10 hardware.

13. Align and adjust the Grille Guard as necessary. Tighten all remaining hardware; M10 to 30-35 ft-lbs., M12 to 50-55 ft-lbs.
14. For the 57-3680 HDX Grille Guard, headlight glare may exist from light reflecting off the wings. If this condition exists use the supplied black anti-reflective tape on the back of the wings to reduce it.



Sportsman GG Installation Complete



HDX GG Installation Complete

**CARE INSTRUCTIONS**

- REGULAR WAXING IS RECOMMENDED. DO NOT USE ANY TYPE OF POLISH OR WAX THAT MAY CONTAIN ABRASIVES
- STAINLESS STEEL PRODUCTS CAN BE CLEANED WITH MILD SOAP AND WATER. STAINLESS STEEL POLISH SHOULD BE USED TO POLISH SMALL SCRATCHES
- GLOSS BLACK FINISHES SHOULD BE CLEANED WITH MILD SOAP AND WATER



Thank You for choosing Westin products.

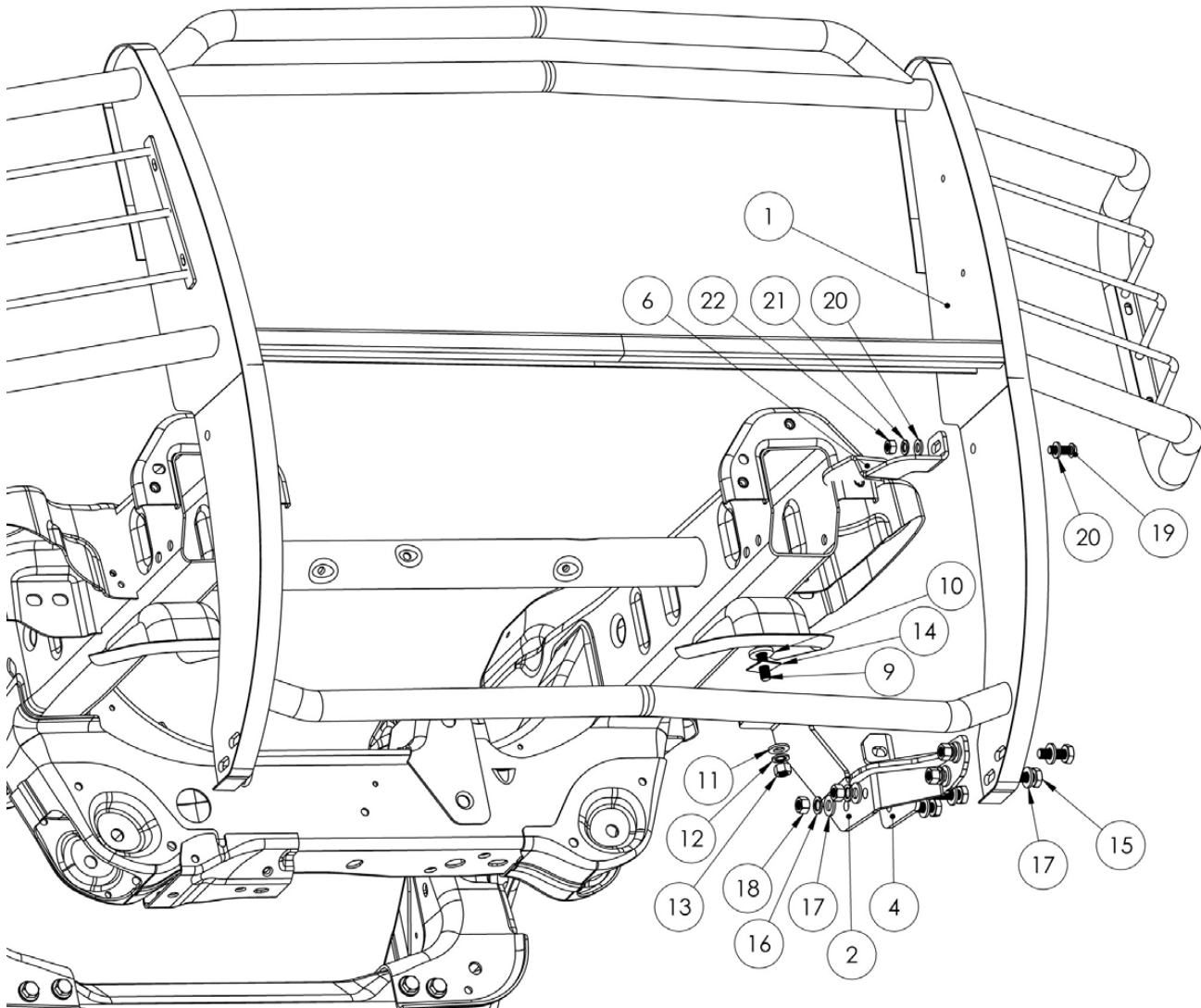

SPORTSMAN GRILLE GUARD EXPLODED VIEW (HDX SIMILAR)



Thank You for choosing Westin products.