

Marine Catalog



Table of contents

Welcome to Webasto marine	4
What's new?	6
We are here to help develop your business	8

Heating products

Heating products 11



Accessories for heating systems 38



Cooling products

Cooling products 70



Accessories for cooling systems 108



Integrated solutions

134



Roof & Shading Solutions

143

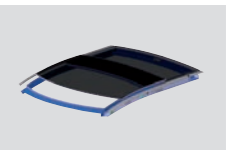

Heating Products

Heating Accessories

Cooling Products

Cooling Accessories

Integrated Solutions

Roof & Shading

Welcome to Webasto Marine



Dear Customers, Dear Partners,

Our Webasto marine team would like to thank you again for your periodical feedback on our products and for sharing your future needs. This unique customer-supplier cooperation brings an immense value to us and is one of the main input for our future product roadmaps. Your ideas to improve comfort on board, your needs to simplify your systems, your suggestions to facilitate installations and ease diagnosis, even from a remote location are indeed systematically studied with high attention. Our engineering teams have the duty to develop innovative technological solutions to match or to surpass your expectations.

Our long-term innovation-based growth strategy is based on this partnership approach. Our commitment to innovation has been making up our great success over the last years and hopefully for many more years to come. We do hope that the numerous new products which are once again being launched in this catalog will match your initial expectations and enhance our complete on board climate solutions with many additional benefits valued by your own customers.

In this new marine catalog 2020, we keep on with our innovation pace not only by introducing several new products in our climate control range but also by launching a complete new range of shading solutions, complementary to our leading roof systems.

You will discover in the following pages our new BlueCool V77T which expands our range of variable speed chillers and opens multiple combination opportunities with our award-winning bestseller BlueCool V50 unit. As with any unit in our standardized BlueCool Air-conditioning solution range, the BlueCool V77T unit benefits from the BlueCool MyTouch customizable display, the CAN bus connectivity and the BlueCool Expert installation/diagnosis tool. All BlueCool A-series Air handlers benefit now from the optional Ultimate Cabin Control combining in one box a high performance silencer and a multiple-device networking capability.

On the heating side, we can highlight the introduction of the Thermo Pro 120/150 water heaters. They come with state-of-the-art technology and unique features to tackle the higher capacity heating segments.

The Folding Shade 2500 and the Rolling Shade 2500 are our first answer to your repetitive requests to get high quality shading solutions from Webasto. Potential is high in combination with our marine roof wide product offering. More will come after we collect your first field experiences next year. Call us!

The purpose of this catalog is not only to give you a complete, practical insight into our large marine product portfolio but also to enable you to build complete climate solutions adapted to the demands of your customers for heating, cooling, light and fresh air on board. Should you require a custom-made solution for a special project, our engineering teams also have the capability to develop customized products to support you. Just get in touch with us!

International service and consistent quality of support are an essential part of our customer excellence programs. The marine catalog is only one element of the complete set of tools and services with which we systematically provide to every Webasto marine partner. Please don't hesitate to register for our technical training sessions, to request access to our dealer portal, to download our diagnosis and calculation tools, our product information and marketing materials. We are here to support your business so that your customers can enjoy the same high quality service with our products worldwide. Our financial strength, our unique product portfolio, our large international dealer network and our understanding of your key strategic challenges for the future have positioned us as your supplier of choice when it comes to complete comfort solutions.

We would like to thank you again for your continuous feedback and your trust in our products. Your success is our success!

Your Webasto Marine Team

What's new?

The new marine catalog provides you with detailed information on our core products as well as on our added-value accessories. You can then build safe applications and deliver fast, professional assistance to your own customers.

Extension of BlueCool V-Series

- Two capacities of 64 and 77 kBTU/h extend the successful V-Series range
- Unique hybrid concept with two independent refrigerant circuits inside
- Innovative hybrid control logic is able to reduce cooling capacity output by 89% down to 8,5 kBTU/h to ensure stable cooling operation.
- Super silent operation with little noise variations and sound cover housing
- Condensate free operation
- 3 ECO modes with adjustable amperage draw allowing the unit to adapt to varying situations, e.g. high amp. consumers active or limited shore power supply
- 230 V/50 Hz or 240 V/60 Hz compatible for worldwide application
- MyTouch as standard user interface with clear text display

New Ultimate Cabin Control for BlueCool A-Series

- Ultra silent blower operation due to PWM control
- Innovative Master-Slave integration allows to connect multiple units together
- Individually adjustable 5 step fan speed
- Compatible to all BlueCool A-Series air handlers
- Meets highest EMC requirements of EN 60945
- One MyTouch display can operate all connected cabin controls

BlueCool MyTouch

- Touch display control unit as standard for all BlueCool A/C series
- Intuitive operation thanks to simple symbols and a clearly organized control menu in ten languages
- Three digital designs allow to customize the user menu
- Upload of own logo or photograph as standby image
- New functions such as a timer, error messages with descriptions, display of operating values and a configuration of the standby display
- Compatible with Vimar Eikon, Eikon Evo and other cover plates



BlueCool V-Series



Ultimate Cabin Control for BlueCool A-Series



BlueCool MyTouch

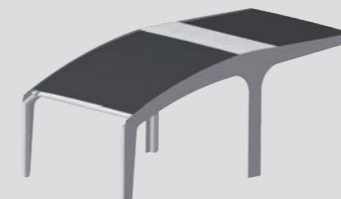

Shading Solutions



Thermo Top Pro 120/150



Thermo Top Evo

NEW

Thermo Top Pro 120/150 water heater

- New generation of water heaters in the high-performance categories of 12 and 15 kW
- Small, light and lean design
- Conventional diesel fuel and 100% paraffinic diesel fuel (incl. renewable fuels, such as HVO)
- ECU and all connections on one side
- Easy to reach plugs for a fast installation
- Low noise emission
- Automatic altitude compensation up to 3,500 m NHN
- More safety and diagnostic functions
- New, powerful coolant pump U4850
- Greater performance and innovation in terms of customer comfort & safety
- Available in 12 and 24 V versions
- Ideally suited for use in marine environment

New Shading Solutions:

Folding Shade 2500 & Rolling Shade 2500

- For application above cockpit, rear deck or fly bridge
- Easy to use, operation of the system by the touch of a button
- Smart & customizable design to perfectly match the style of the boat
- Based on automotive kinematics and drive systems
- Tension & locking system for tensioning the fabric
- Simple and effective installation results in limited installation time

New Thermo Top Evo Marine New Generation

- New efficient water heater with 1.8 up to 5 kW of heating power
- Exhaust temperature sensor for more safety
- Lightweight super compact successor of the Thermo Top C
- Stepless coolant control, regulates the heat output for stable air temperature
- Lower power consumption
- Low noise emission
- Available in 12 V
- MultiControl as standard user interface

New ThermoConnect

- Control your heater from anywhere
- Departure time-based heating
- Custom programming for individual or frequent heating processes
- Control of multiple boats
- Interior temperature display
- Boat position can be located
- Geofencing: alerts customer when ThermoConnect leaves a defined geographical area
- Can be linked to smart home systems (Alexa compatible)

We are here to help develop your business

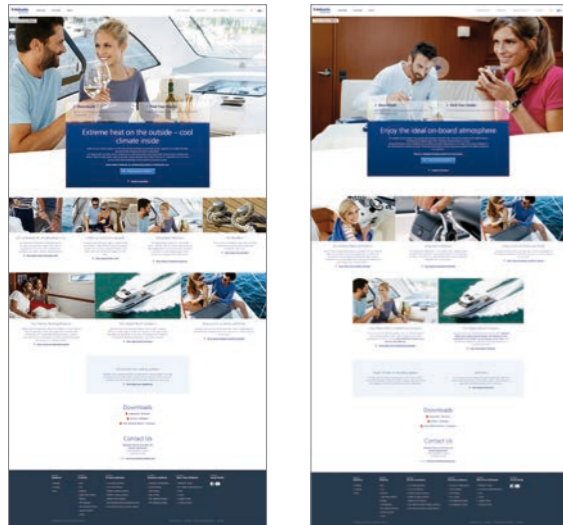

Marine website

- webasto-marine.com
- Quick and appealing product guide
- International dealer locator
- Multi-lingual access
- Marine configurator



Marine training program and technical guidelines

- Powerful product training – also web-training
- Regular updates on new features
- Various modules adapted to audience
- Important guidelines for safe application engineering
- CAD model downloads

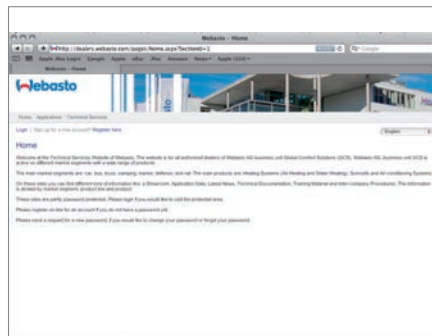

Dealer portal

- <http://dealers.webasto.com>
- Easy access to complete Webasto documentation
- Powerful search and download tools
- Login-protected access to technical data and applications



Marketing documentation and materials

- Marine marketing materials: product brochures, flyers, advertising templates, banners
- Marine animations
- Product data sheets
- Dealer packages

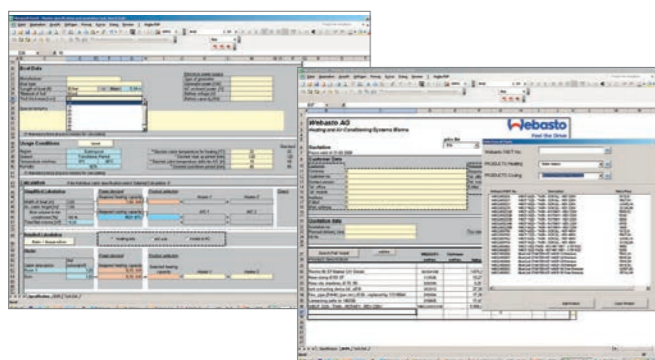

Webasto quote generator

- All the Webasto expertise at your finger tips
- Accurate quotations documented professionally
- Quick response to your customer requests
- Fresh air calculation included
- Accurate calculation of the cooling or heating demand
- The Webasto quote generator also exists for professional roof quotations

This catalog has been designed to help you in defining a complete comfort solution for boats and yachts.

Page header indicates which part and type of information you reached within each product section:
Product overview, scopes of delivery, accessories, etc.

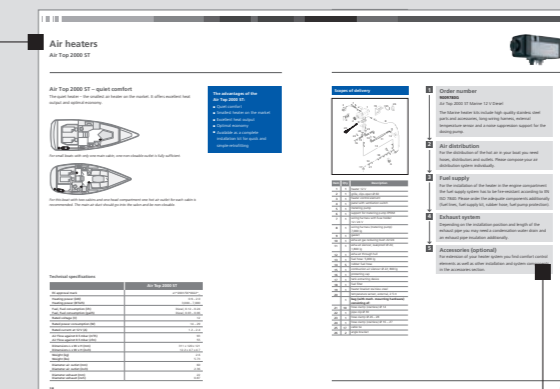

Colored labels give you direct access to the product range

Page indication for fast access to accessories, etc.



Heating products

Which heater for your boat?	12
<hr/>	
Air heaters	14
Product overview	15
Application concept	16
Selection tool	17
Air Top 2000 STC	18
Air Top Evo 40	20
Air Top Evo 55	22
<hr/>	
Water heaters	24
Product overview	25
Application concept	28
Selection tool	29
Thermo Top Evo/Thermo Pro 50 Eco	30
Thermo Pro 90/Thermo Pro 90 Chiller	32
Thermo Top Pro 120/150	34
<hr/>	
Isotemp hot water boilers	36
<hr/>	

Which heater for your boat?



Along with specific marine installation kits we deliver innovative high-quality air and water heaters, which contribute to the enhancement of comfort on board. These two technologies offer economical, powerful and reliable solutions with heating outputs ranging from 2 kW up to 15 kW. Thus, there is a Webasto heating solution for various needs.

Air heaters



- Short heating-up times thanks to effective output
- Available as a complete installation kit for quick and simple retrofitting
- Dehumidification of the cabins
- Silent operation
- Ideal for sailing and motor boats up to 45 feet
- Constant coziness thanks to an electronic thermostat
- Low operating costs
- Practical ventilation function
- Meet current requirements and standards relating to boats
- Simple to install
- Compact, space-saving design

or

Water heaters

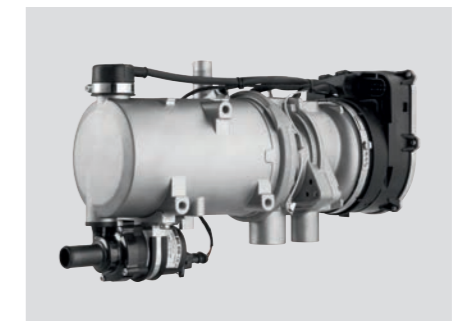

- Heating comfort just like at home
- Even distribution of warmth by means of radiators
- Hot water for the shower and galley
- Silent operation
- Space-saving installation in the engine room
- Excellent possibilities for combining with Webasto BlueCool air-conditioning systems
- Separate temperature control in every cabin
- Low fuel consumption
- Compact design
- Preheating of the engine possible to avoid cold starts
- Meet current requirements and standards relating to boats
- Robust aluminum casing, resistant to high temperature or salt

Air heaters

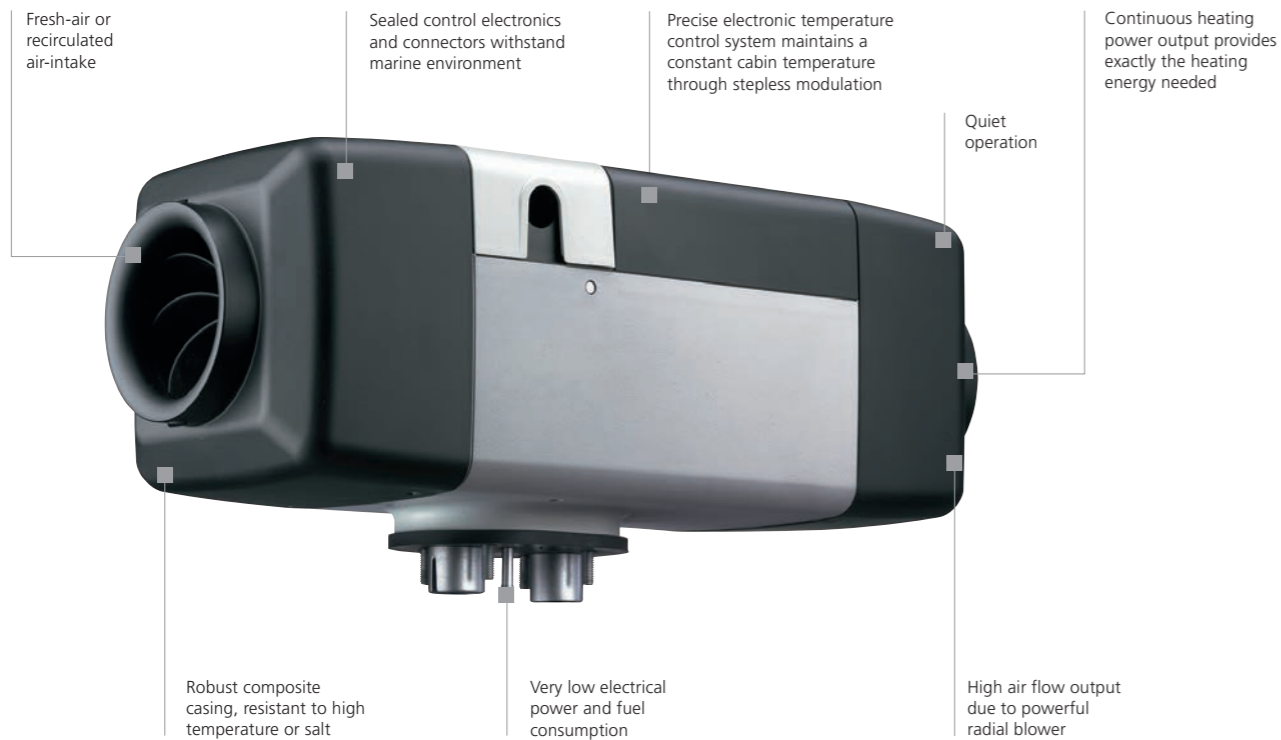

NEW



3 Heaters in 1 with the MultiControl!

- Available as an upgrade on all Webasto Air Top Evo heaters
- Multi mode operation to match your individual heating power demands:
 - ECO mode for reduced electrical power consumption
 - Boost mode for maximum heating power output
 - Ventilation mode to provide fresh and cool air to your cabins on a hot day

New ThermoConnect App

- Our new ThermoConnect app lets you control your water or air heater smarter and more flexibly than ever before. Available for IOS and Android devices.



Air heaters

Product overview



Air Top 2000 STC [SEE PAGE 18](#)



Air Top Evo 40 [SEE PAGE 20](#)

Air Top Evo 55 [SEE PAGE 22](#)

Technical specifications

	Air Top 2000 STC	Air Top Evo 40*	Air Top Evo 55**
ECE R122 (Heater)	E1 122R- 00 0216	E1 122R-00 0385	E1 122R-00 0386
ECE R10 (EMC)		E1 10R-05 5529	E1 10R-05 5529
Heat output (kW)	0.9 – 2.0	1.5 – 3.5 (4.0*)	1.5 – 5.0 (5.5*)
Heat output (BTU/h)	3,000 – 7,000	5,100 – 12,000 (13,600*)	5,100 – 17,000 (18,800*)
Fuel, Fuel consumption (l/h)	Diesel, 0.12 – 0.24	Diesel, 0.18 – 0.43 (0.49)	Diesel, 0.18 – 0.61 (0.67)
Fuel, Fuel consumption (gal/h)	Diesel, 0.03 – 0.06	Diesel, 0.04 – 0.11 (0.12)	Diesel, 0.04 – 0.15 (0.17)
Rated voltage (V)	12	12, 24	12, 24
Rated power consumption (W)	14 – 29	15 – 40 (55)	15 – 95 (130)
Rated current (for 12 V) (A)	1.2 – 2.4	1.3 – 3.3 (4.6)	1.3 – 7.9 (10.8)
Rated current (for 24 V) (A)	–	0.6 – 1.7 (2.3)	0.6 – 4.0 (5.4)
Air Flow against 0.5 mbar (m³/h)	93	max. 132 (140)	max. 200 (220)
Air Flow against 0.5 mbar (cfm)	55	77.7 (82)	117.7 (129.4)
Dimensions L x W x H (mm)	310 x 120 x 118	423 x 148 x 162	423 x 148 x 162
Dimensions L x W x H (inch)	12.2 x 4.7 x 4.7	16.6 x 5.8 x 6.3	16.6 x 5.8 x 6.3
Weight (kg)	2.6	5.9	5.9
Weight (lbs)	5.73	13	13
Diameter air outlet (mm)	60	90	90
Diameter air outlet (inch)	2.36	3.54	3.54
Diameter exhaust (mm)	22	24	24
Diameter exhaust (inch)	0.87	0.94	0.94

* Boost power level for a maximum duration of 6 hrs. ** Boost power level for a maximum duration of 30 min.

Air heaters

Application concept

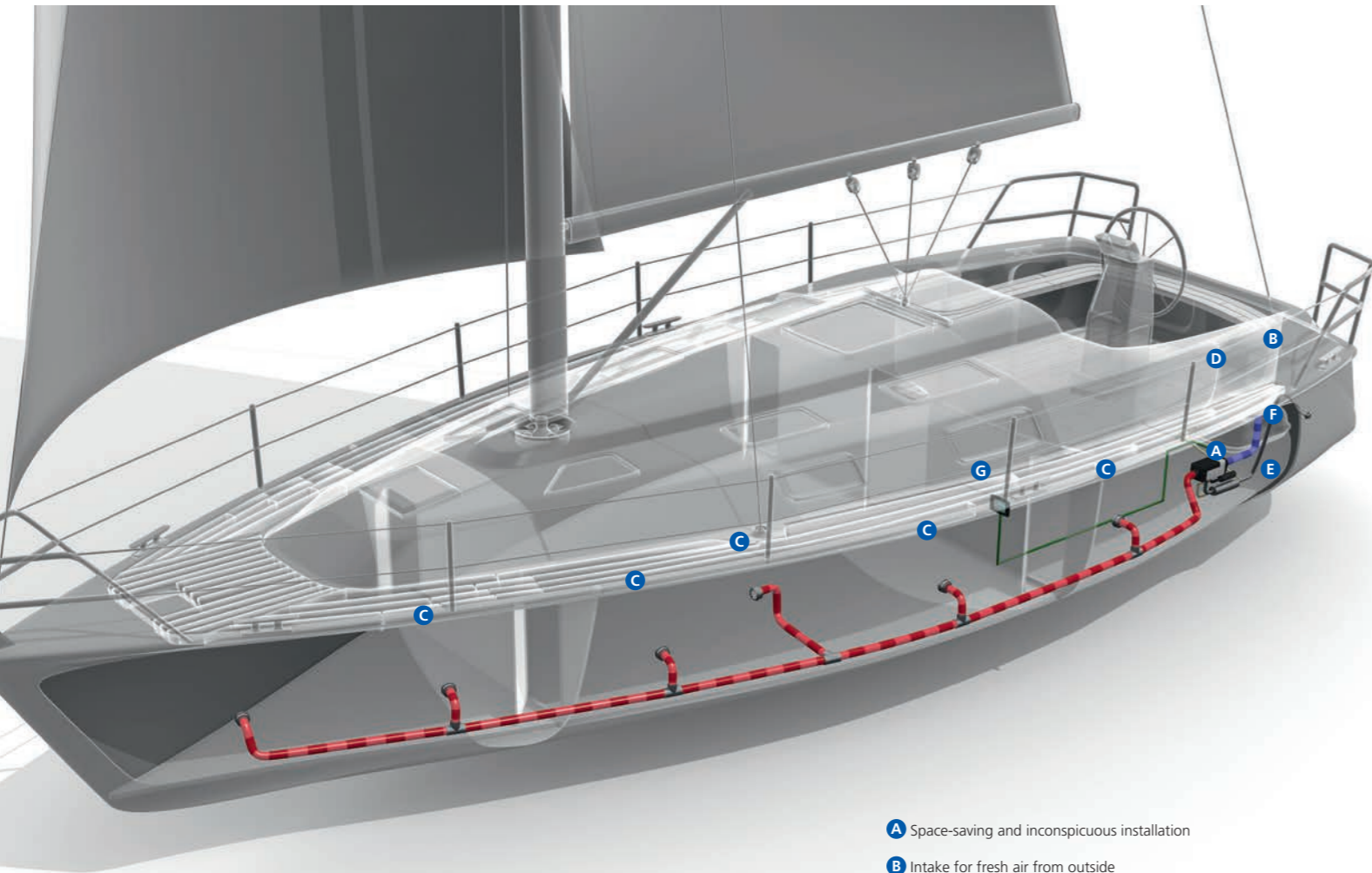

- A** Space-saving and inconspicuous installation
- B** Intake for fresh air from outside
- C** Outlets for even distribution of warm air
- D** Safe and clean: the fuel system
- E** Combustion-air intake
- F** Stainless steel exhaust
- G** Controls – simple and logical to use

Air heaters

Selection tool

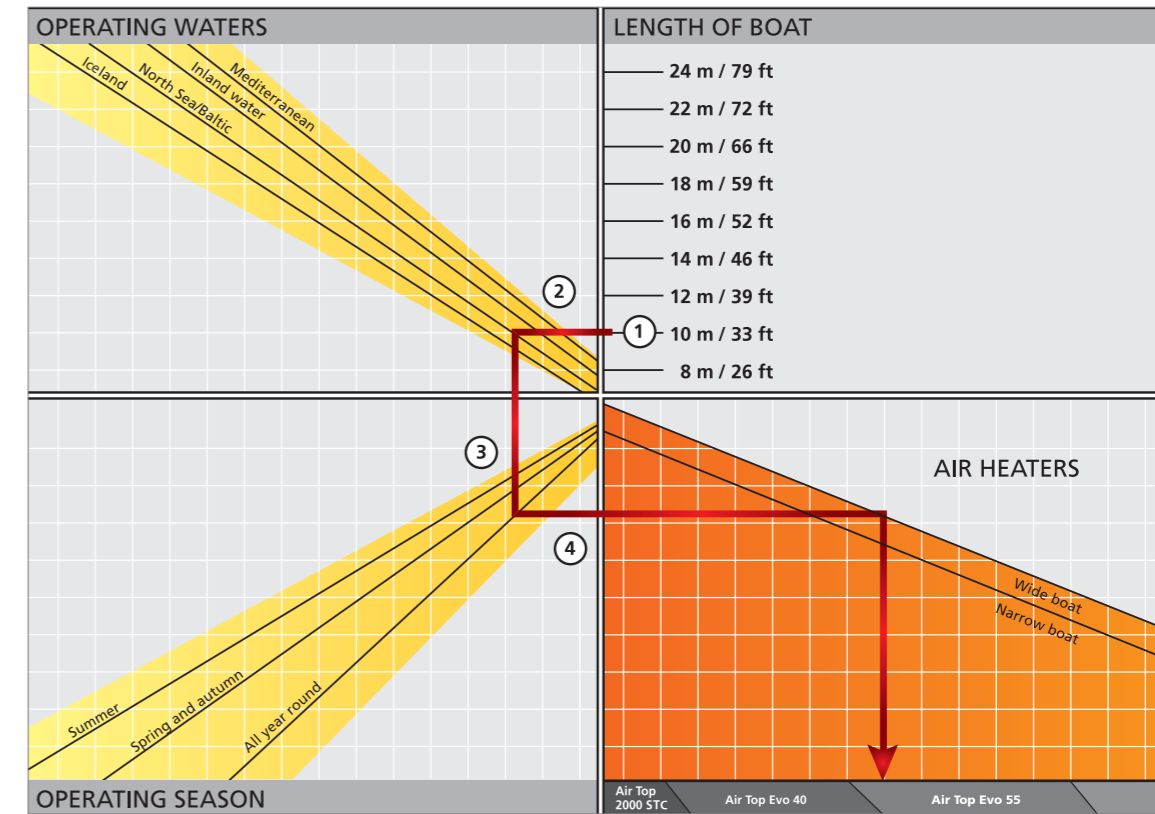

What's the best air heating system for my boat?

1. Select the length corresponding to your boat.
2. From there, trace a line to the left until you come to the line corresponding to the waters in which you plan to operate.
3. From there, trace a line vertically downwards until you come to the line corresponding to the season in which you plan to operate.
4. From there, trace a line to the right: You find the line corresponding to your type of boat in the upper section and then trace a line vertically downwards – that's the recommended system.

Air heaters

Air Top 2000 STC



Air Top 2000 STC – quiet comfort

The quiet heater – the smallest air heater on the market. It offers excellent heat output and optimal economy.

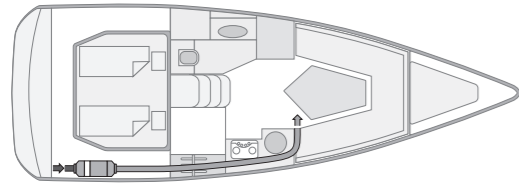

For small boats with only one main cabin, one non-closable outlet is fully sufficient.

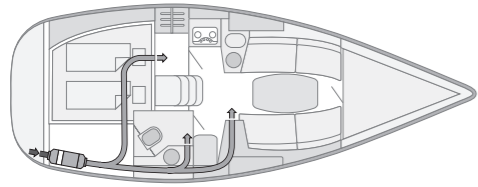

For this boat with two cabins and one head compartment one hot air outlet for each cabin is recommended. The main air duct should go into the salon and be non-closable.

The new advantages of the Air Top 2000 STC marine kits

- New split marine wiring harness with two branches to battery and cabin control
- Two ports for diagnosis and MultiControl
- Low noise dosing pump with PWM operation
- New external temperature sensor with new design
- Transparent fuel hose for easy inspection (not in U.S)
- Easy combination with new MultiControl
- Easy to service and maintain, diagnostic capability
- Full W-bus compatibility of the heater
- Improved combustion air silencer reduces noise level

Technical specifications

Air Top 2000 STC	
EC approval mark	E1 122R- 00 0216
Heating power (kW)	0.9 – 2.0
Heating power (BTU/h)	3,000 – 7,000
Fuel, Fuel consumption (l/h)	Diesel, 0.12 – 0.24
Fuel, Fuel consumption (gal/h)	Diesel, 0.03 – 0.06
Rated voltage (V)	12
Rated power consumption (W)	14 – 29
Rated current at 12 V (A)	1.2 – 2.4
Air Flow against 0.5 mbar (m³/h)	93
Air Flow against 0.5 mbar (cfm)	55
Dimensions L x W x H (mm)	310 x 120 x 118
Dimensions L x W x H (inch)	12.2 x 4.7 x 4.7
Weight (kg)	2.6
Weight (lbs)	5.73
Diameter air outlet (mm)	60
Diameter air outlet (inch)	2.36
Diameter exhaust (mm)	22
Diameter exhaust (inch)	0.87

Scopes of delivery

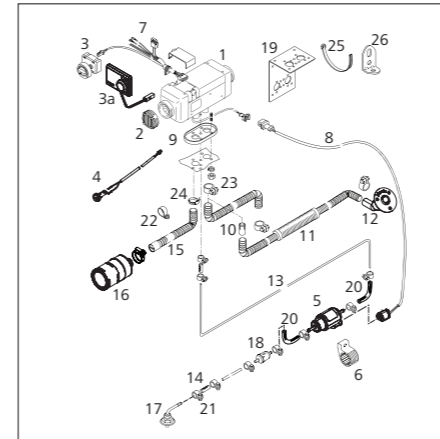

Item	Qty	Description
1	1	Heater 12 V
2	1	Grille, clips open Ø 60
3	1	Heater control element
3a	1	MultiControl
4	1	Temperature sensor, external 2.5 m
5	1	Metering pump
6	1	Support for metering pump EPDM
7	1	Wiring harness with fuse holder 12 / 24 V
8	1	Wiring harness (metering pump) 7,000 lg
9	1	Gasket
10	1	Exhaust gas reducing bush 22/24
11	1	Exhaust silencer, leakproof Ø 24; 1,800 lg
12	1	Exhaust through hull
13	1	Transparent fuel hose: 5,000 lg
14	5	Rubber fuel hose
15	1	Combustion air intake hose 300 lg
16	1	Combustion air intake silencer
17	1	Tank extracting device
18	1	Fuel filter
19	1	Heater bracket stainless steel
20	1	Vibration damper for fuel hose
	1	Bag (with mech. mounting hardware) consisting of:
21	10	Hose clamp (stainless) Ø 14
22	1	Pipe clip Ø 30
23	1	Hose clamp Ø 26 – 28
24	1	Hose clamp (stainless) Ø 16 – 27
25	17	Cable tie
26	2	Angle bracket

1

Order number

9032164C

Air Top 2000 STC Marine 12 V Diesel with standard heater control element

9034777C

Air Top 2000 STC Marine 12 V Diesel with MultiControl

The Marine heater kits include high quality stainless steel parts and accessories, external temperature sensor and effective combustion and exhaust air silencers.

2

Air distribution

For the distribution of the hot air in your boat you need hoses, distributors and outlets. Please compose your air distribution system individually.

3

Fuel supply

For the installation of the heater in the engine compartment the fuel supply system has to be fire-resistant according to EN ISO 7840. Please order the adequate components additionally (fuel lines, fuel supply kit, rubber hose, fuel pump protection).

4

Exhaust system

Depending on the installation position and length of the exhaust pipe you may need a condensation water drain and an exhaust pipe insulation additionally.

5

Accessories (optional)

For extension of your heater system you find comfort control elements as well as other installation and system components in the accessories section.

Air heaters

Air Top Evo 40



Air Top Evo 40 – the smart multi mode heater

High-output, compact and quiet, the heater is ideally suited for the most rigorous requirements. It can be upgraded with the new multi mode control panel to offer additional operation modes depending on individual heating requirements.

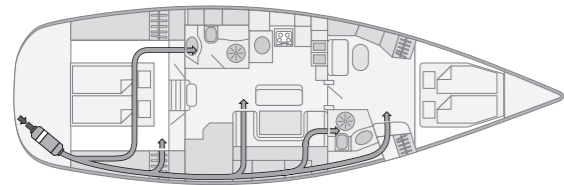

Each cabin and head compartment has its own air outlet. One outlet should be non-closable. The temperature sensor as well as the main air outlet is in the salon. The fresh air is taken in via the rear locker from outside.

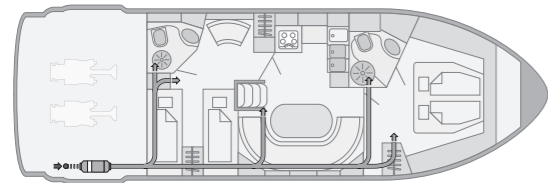

In motor boats, the heater is usually placed in the engine compartment. The fresh air has to be taken in from outside the engine room. Special attention needs to be paid to a fire-resistant fuel supply system. One of the outlets should be non-closable.

Technical specifications

	Air Top Evo 40*
EC approval mark ECE R122 (Heating)	E1 000385
EC approval mark ECE R10 (EMC)	E1 035529
Heating power (kW)	1.5 – 3.5 (4.0*)
Heating power (BTU/h)	5,100 – 12,000 (13,600*)
Fuel, Fuel consumption (l/h)	Diesel 0.18 – 0.43 (0.49)
Fuel, Fuel consumption (gal/h)	Diesel 0.04 – 0.11 (0.12)
Rated voltage (V)	12, 24
Rated power consumption (W)	15 – 40 (55)
Rated current at 12 V (A)	1.3 – 3.3 (4.6)
Rated current at 24 V (A)	0.6 – 1.7 (2.3)
Air Flow against 0.5 mbar (m³/h)	140
Air Flow against 0.5 mbar (cfm)	82.4
Dimensions L x W x H (mm)	423 x 148 x 162
Dimensions L x W x H (inch)	16.6 x 5.8 x 6.3
Weight (kg)	5.9
Weight (lbs)	13
Diameter air outlet (mm)	90
Diameter air outlet (inch)	3.54
Diameter exhaust (mm)	24
Diameter exhaust (inch)	0.94

* Boost power level for a maximum duration of 6 hrs.

The advantages of the Air Top Evo 40:

- 4.0 kW power for fast heating
- Very low electrical power consumption due to new Intelligent Blower Control
- New flame detection through exhaust gas temperature sensor
- Automatic cold start function for quick warm-up
- Improved air intake silencer
- Vibration dampers for fuel line
- Compatible to new MultiControl digital user interface
- Very silent operation due to lower blower speed and silent fuel pump (DP42)

What is the Intelligent Blower Control?

Thanks to the control of more parameters (more sensors), the heating regulation can now disconnect, to a certain extent, the heating output from the blower speed, resulting in:

- A lower electrical consumption and lower noise on regular operation (lower motor speed for same heat output).
- A higher heat output availability for applications with higher back pressure.

Scopes of delivery

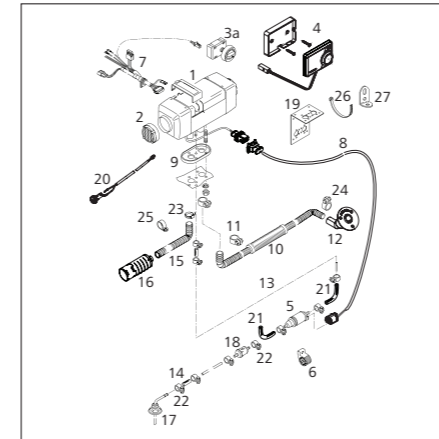

Item	Qty	Description
1	1	Heater 12 or 24 V
2	1	Grille
3a	1	Standard heater control element
4	1	MultiControl
5	1	Metering pump 12 or 24 V
6	1	Support for metering pump EPDM
7	1	Wiring harness (heater); 9,500 lg
8	1	Wiring harness (metering pump) 7,000 lg
9	1	Gasket
10	1	Exhaust silencer leakproof 1,800 lg
11	1	Hose clamp Ø 28 – 35
12	1	Exhaust through hull
13	1	Transparent fuel hose 12 V: 5,000 lg; 24 V: 8,000 lg
14	5	Rubber fuel hose
15	1	Combustion air intake hose 300 lg
16	1	Combustion air intake silencer
17	1	Tank extracting device
18	1	Fuel filter
19	1	Heater bracket stainless steel
20	1	Temperature sensor, external 2.5 m
21	2	Vibration damper for fuel hose
	1	Bag (with mech. mounting hardware) consisting of:
22	10	Hose clamp (stainless steel) Ø 14
23	1	Hose clamp Ø 16 – 27 (combustion air)
24	2	Hose clamp Ø 26 – 28 (exhaust)
25	1	Pipe clip (stainless steel) Ø 30
26	17	Cable tie
27	2	Angle bracket

1

Order number

9029249A

Air Top Evo 40 Marine 12 V Diesel with standard heater control element

9029250A

Air Top Evo 40 Marine 24 V Diesel with standard heater control element

9036994A

Air Top Evo 40 Marine 12 V Diesel with MultiControl

9036995A

Air Top Evo 40 Marine 24 V Diesel with MultiControl

The Marine heater kits include high quality stainless steel parts and accessories, long wiring harness, external temperature sensor and effective combustion and exhaust air silencers.

2

Air distribution

For the distribution of the hot air in your boat you need hoses, distributors and outlets. Please compose your air distribution system individually.

3

Fuel supply

For the installation of the heater in the engine compartment the fuel supply system has to be fire-resistant according to EN ISO 7840. Please order the adequate components additionally (fuel lines, fuel supply kit, rubber hose, fuel pump protection).

4

Exhaust system (optional)

Depending on the installation position and length of the exhaust pipe you may need a condensation water drain and an exhaust pipe insulation additionally.

5

Accessories (optional)

For extension of your heater system you find comfort control elements as well as other installation and system components in the accessories section.

Air heaters

Air Top Evo 55



Air Top Evo 55 – for extreme conditions

Extremely powerful, compact and quiet, this heater ensures a comfortable climate for larger yachts even under the harshest conditions, and satisfies the most demanding requirements. It can be upgraded with the new multi mode user interface to offer additional operation modes depending on individual heating requirements.

Two Air Top heaters can be combined into one system for increased heating demand (up to 11 kW). The whole system can be operated via one central user interface.

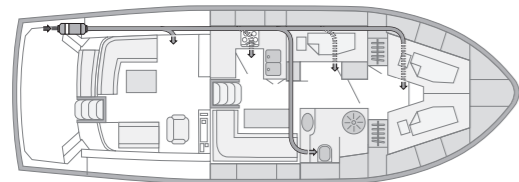

Each of this five cabin yacht has an individual air outlet. The air duct to the salon as well as the front should have at least 80 mm Ø to ensure a good air flow and one of the outlets should be non-closable. The fresh air is taken in via the rear locker from outside.

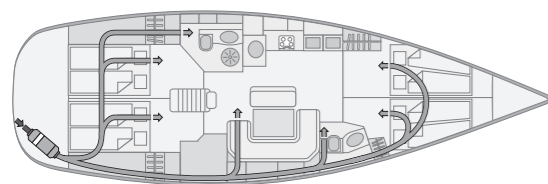

With the heater in the engine compartment, the fuel supply system must be designed to be fire-resistant. The air outlet to the salon has to be non-closable. Air outlets for the other cabins or the head compartment may be closable to enable individual heat regulation.

Technical specifications

	Air Top Evo 55*
EC approval mark ECE R122 (Heating)	E1 000385
EC approval mark ECE R10 (EMC)	E1 035529
Heating power (kW)	1.5 – 5.0 (5.5*)
Heating power (BTU/h)	5,100 – 17,000 (18,800*)
Fuel, Fuel consumption (l/h)	Diesel 0.18 – 0.61 (0.67)
Fuel, Fuel consumption (gal/h)	Diesel 0.04 – 0.15 (0.17)
Rated voltage (V)	12, 24
Rated power consumption (W)	15 – 95 (130)
Rated current at 12 V (A)	1.3 – 7.9 (10.8)
Rated current at 24 V (A)	0.6 – 4.0 (5.4)
Air Flow against 0.5 mbar (m³/h)	220
Air Flow against 0.5 mbar (cfm)	129
Dimensions L x W x H (mm)	423 x 148 x 162
Dimensions L x W x H (inch)	16.6 x 5.8 x 6.3
Weight (kg)	5.9
Weight (lbs)	13
Diameter air outlet (mm)	90
Diameter air outlet (inch)	3.54
Diameter exhaust (mm)	24
Diameter exhaust (inch)	0.94

* Boost power level for a maximum duration of 30 min.

The advantages of the Air Top Evo 55:

- 5.5 kW power for fast heating
- Very low electrical power consumption due to new Intelligent Blower Control
- New flame detection through exhaust gas temperature sensor
- Automatic cold start function for quick warm-up
- Improved air intake silencer
- Vibration dampers for fuel line
- Compatible to new MultiControl digital user interface
- Very silent operation due to lower blower speed and silent fuel pump (DP42)

What is the Intelligent Blower Control?

Thanks to the control of more parameters (more sensors), the heating regulation can now disconnect, to a certain extent, the heating output from the blower speed, resulting in:

- A lower electrical consumption and lower noise on regular operation (lower motor speed for same heat output).
- A higher heat output availability for applications with higher back pressure.

Scopes of delivery

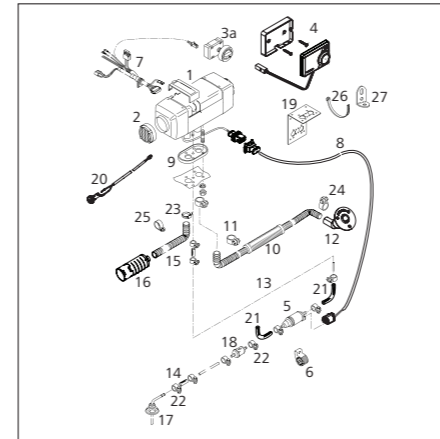

Item	Qty	Description
1	1	Heater 12 or 24 V
2	1	Grille
3a	1	Standard heater control element
4	1	MultiControl
5	1	Metering pump 12 or 24 V
6	1	Support for metering pump EPDM
7	1	Wiring harness (heater); 9,500 lg
8	1	Wiring harness (metering pump) 7,000 lg
9	1	Gasket
10	1	Exhaust silencer leakproof 1,800 lg
11	1	Hose clamp Ø 28 – 35
12	1	Exhaust through hull
13	1	Fuel hose 12 V: 5,000 lg; 24 V: 8,000 lg
14	5	Rubber fuel hose
15	1	Combustion air intake hose 300 lg
16	1	Combustion air intake silencer
17	1	Tank extracting device
18	1	Fuel filter
19	1	Heater bracket stainless steel
20	1	Temperature sensor, external 2.5 m
21	2	Vibration damper for fuel hose
	1	Bag (with mech. mounting hardware) consisting of:
22	10	Hose clamp (stainless steel) Ø 14
23	1	Hose clamp Ø 16 – 27 (combustion air)
24	2	Hose clamp Ø 26 – 28 (exhaust)
25	1	Pipe clip (stainless steel) Ø 30
26	17	Cable tie
27	2	Angle bracket

1

Order number

9029256A
Air Top Evo 55 Marine 12 V Diesel with standard heater control element

9029257A
Air Top Evo 55 Marine 24 V Diesel with standard heater control element

9036996A
Air Top Evo 55 Marine 12 V Diesel with MultiControl

9036998A
Air Top Evo 55 Marine 24 V Diesel with MultiControl

The Marine heater kits include high quality stainless steel parts and accessories, long wiring harness, external temperature sensor and effective combustion and exhaust air silencers.

2

Air distribution

For the distribution of the hot air in your boat you need hoses, distributors and outlets. Please compose your air distribution system individually.

3

Fuel supply

For the installation of the heater in the engine compartment the fuel supply system has to be fire-resistant according to EN ISO 7840. Please order the adequate components additionally (fuel lines, fuel supply kit, rubber hose, fuel pump protection).

4

Exhaust system (optional)

Depending on the installation position and length of the exhaust pipe you may need a condensation water drain and an exhaust pipe insulation additionally.

5

Accessories (optional)

For extension of your heater system you find comfort control elements as well as other installation and system components in the accessories section.

Water heaters

Thermo Pro 90: The renowned

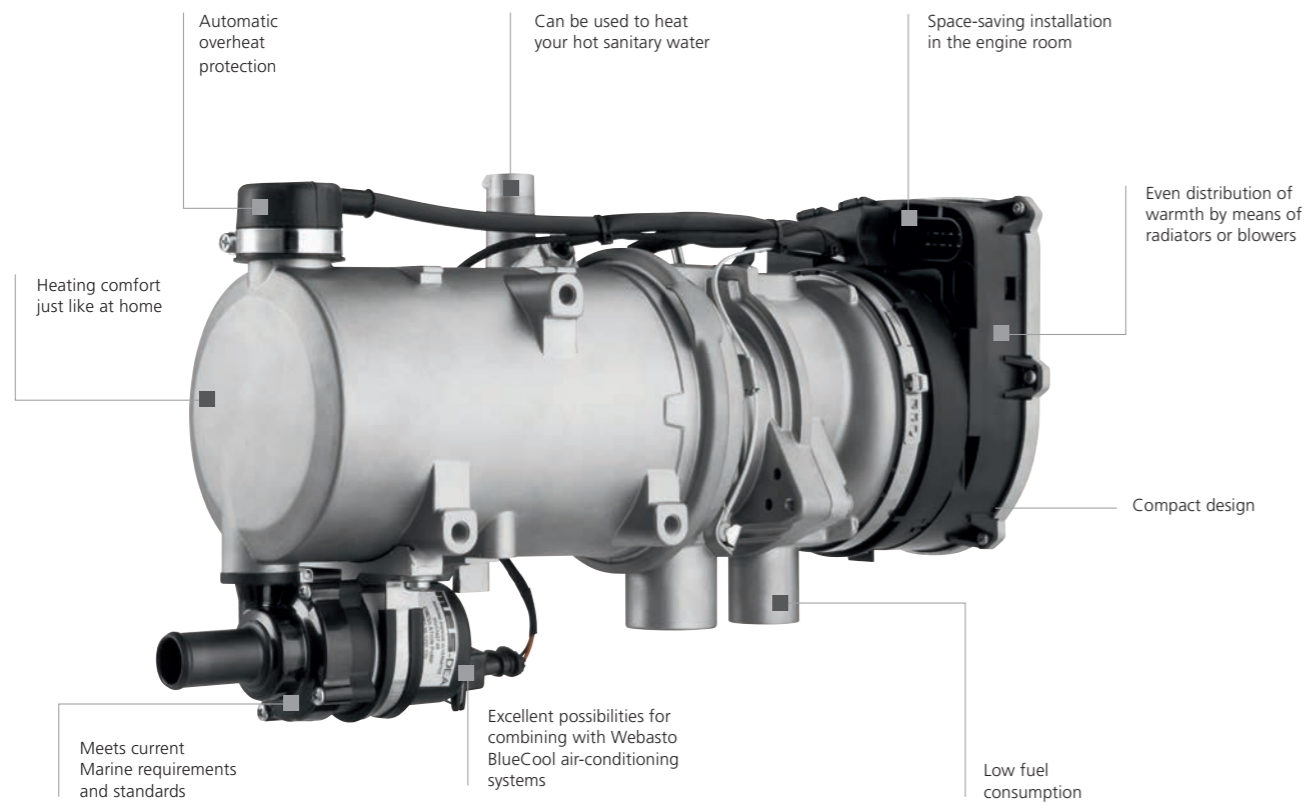

Water heaters

Product overview

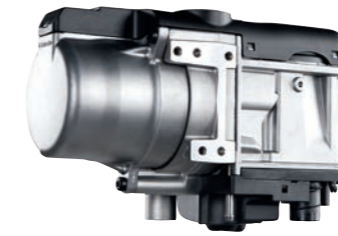

Thermo Top Evo
Thermo Pro 50 Eco

SEE PAGE 30

NEW

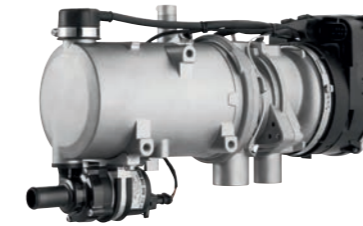

Thermo Pro 90

SEE PAGE 32



Thermo Top Pro 120/150

SEE PAGE 34

NEW

Greater comfort with our innovative Webasto ThermoConnect App. Run your water or air heater easily with a smartphone.



Water heaters

Product overview

	Part no.		EC approval mark	Heat output		Fuel, Fuel consumption	Rated Voltage		Rated power consumption		Flow rate of circulating pumps	Dimensions heater (L x W x H)	Dimensions control unit with mounting (L x W x H)	Weight heater incl. fuel pump
	12 V Diesel	24 V Diesel		part load	full load				part load	full load				
NEW Thermo Top Evo Marine	9038892A	–	E1 00 0258 (ECE R122) E1 04 5627 (ECE R10)	1.8 kW 6,100 BTU/h	5.0 kW 17,100 BTU/h	0.22– 0.62 l/h Diesel, 0.06 – 0.16 gal/h	12 V		10 W 0.8 amps	33 W 2.7 amps	500 l/h against 0.14 bar 2.2 gal/min.	218 x 91 x 147 mm 8.6 x 3.6 x 5.8 inch	68 x 48 x 15 mm 2.7 x 1.9 x 0.6 inch	2.1 kg 4.6 lbs
Thermo Pro 50 E Marine	–	9028080C	E1 00 0334 (ECE R122) E1 03 6271 (ECE R10)	2.5 kW 8,500 BTU/h	5.0 kW 17,100 BTU/h	Diesel, 0.30 – 0.60 l/h Diesel, 0.08 – 0.16 gal/h	24 V		28 W 1.2 amps	46 W 1.9 amps	500 l/h against 0.14 bar 2.2 gal/min.	218 x 91 x 144 mm 8.6 x 3.6 x 5.7 inch	–	2.5 kg 5.3 lbs
Thermo Pro 90 Marine	9029940C	9029941C	E1 00 0320 (ECE R122) E1 04 6196 (ECE R10)	1.8 – 7.6 kW 6,100 – 26,000 BTU/h	9.1 kW 31,000 BTU/h	Diesel 0.18 – 1.08/1.3 l/h Diesel 0.05 – 0.24/0.34 gal/h	12 V, 24 V		20 – 83 W 3.0 – 6.9 amps at 12 V 1.5 – 3.5 amps at 24 V	90 W 7.5 amps at 12 V 3.8 amps at 24 V	700 l/h against 0.3 bar 3.1 gal/min.	352 x 131 x 232 mm 13.9 x 5.2 x 9.1 inch	134 x 53 x 90 mm	5.3 kg 11.7 lbs
Thermo Pro 90 Chiller	9029942C	9029943C	E1 00 0320 (ECE R122) E1 04 6196 (ECE R10)	1.8 – 7.6 kW 6,100 – 26,000 BTU/h	9.1 kW 31,000 BTU/h	Diesel 0.18 – 1.08/1.3 l/h Diesel 0.05 – 0.24/0.34 gal/h	12 V, 24 V		20 – 83 W 3.0 – 6.9 amps at 12 V 1.5 – 3.5 amps at 24 V	90 W 7.5 amps at 12 V 3.8 amps at 24 V	700 l/h against 0.3 bar 3.1 gal/min.	352 x 131 x 188 mm 13.9 x 5.2 x 7.4 inch	134 x 53 x 90 mm	4.9 kg 10.8 lbs
Thermo Top Pro 120	9035585A	9035584A	E1 00 0480, E1 00 0481 (ECER122) E1 05 7735 (ECE R 10)	12.0 kW 40,950 BTU/h		Diesel, 1.6 l/h Diesel, 0.42 gal/h	12 V, 24 V		80 W 6.7 amps at 12 V 3.3 amps at 24 V		1,500 l/h against 0.56 bar 6.6 gal/min.	470 x 200 x 200 mm 18.5 x 7.9 x 7.9 inch	–	11.7 kg 25.7 lbs
Thermo Top Pro 150	9035583A	9035582A	E1 00 0480, E1 00 0481 (ECER122) E1 05 7735 (ECE R 10)	15.0 kW 51,180 BTU/h		Diesel, 1.7 l/h Diesel, 0.45 gal/h	12 V, 24 V		100 W 8.3 amps at 12 V 4.2 amps at 24 V		1,500 l/h against 0.56 bar 6.6 gal/min.	470 x 200 x 200 mm 18.5 x 7.9 x 7.9 inch	–	11.7 kg 25.7 lbs

NEW

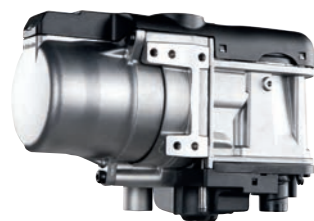

Thermo Top Evo Marine



Thermo Pro 90 Marine



Thermo Top Pro 120/150

Water heaters

Application concept

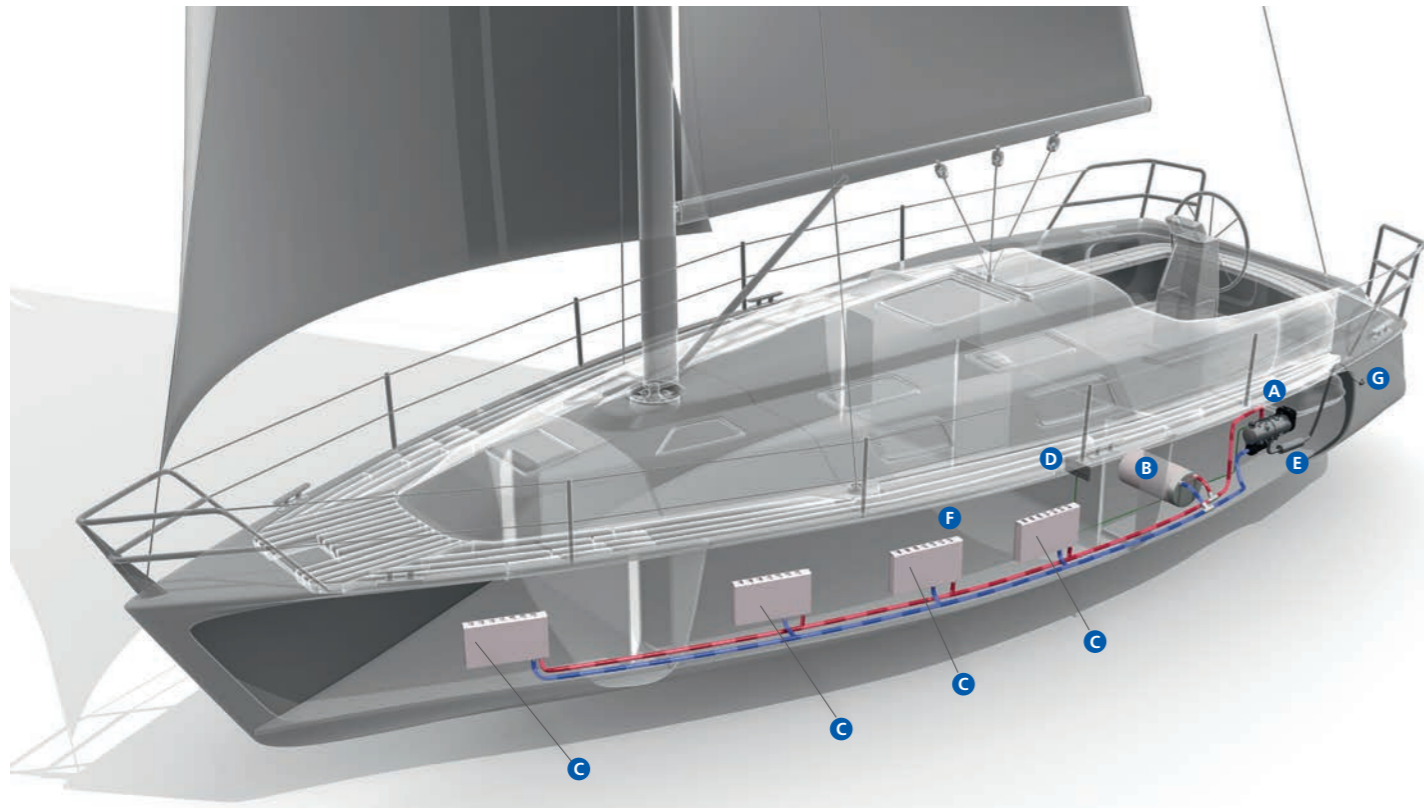

- A** Space-saving and inconspicuous installation in the engine room
- B** Boiler for heating hot water – for extra comfort
- C** One radiator for each cabin allows an individual temperature control
- D** Controls – simple and logical to use
- E** Circulating pump
- F** Fresh water tank
- G** Stainless steel exhaust

Water heaters

Selection tool

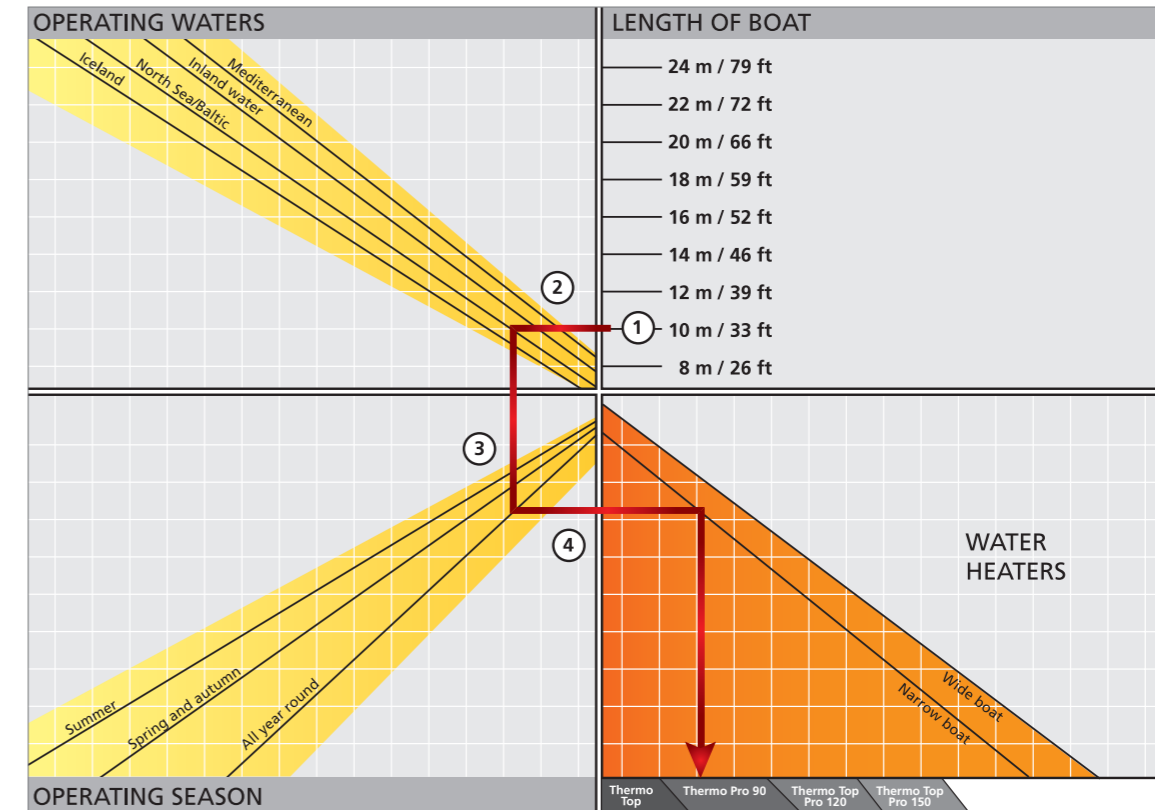

What's the best water heating system for my boat?

1. Select the length corresponding to your boat.
2. From there, trace a line to the left until you come to the line corresponding to the waters in which you plan to operate.
3. From there, trace a line vertically downwards until you come to the line corresponding to the season in which you plan to operate.
4. From there, trace a line to the right: Select the line corresponding to your type of boat in the lower section and then trace a line vertically downwards – that's the recommended system.

Water heaters

Thermo Top Evo/Thermo Pro 50 Eco



Thermo Top water heaters

This compact 5 kW unit is ideal for the majority of marine applications. Compact design, variable temperature control, service friendly technology and low noise levels.

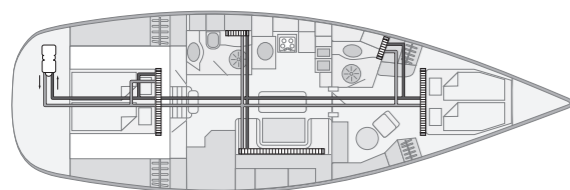

The Thermo Top Evo is placed in the locker compartment of the boat. Radiators are used to heat up the boat, because electrical autonomy in this size of boat is often very important and radiators do not consume electricity of the battery.

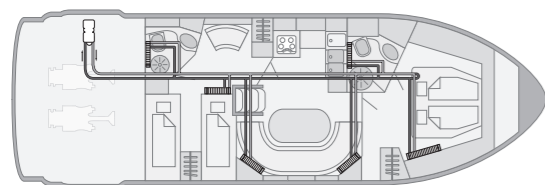

The Thermo Top Evo in the engine compartment is able to heat the entire boat. Each cabin has individually sized convectors to match the heating requirements.

The advantages of water heaters:

- Even distribution of warmth by means of radiators
- Hot water for the shower and galley
- Space-saving installation
- Excellent possibilities for combining with Webasto BlueCool air-conditioning systems
- Separate temperature control in every cabin
- Low fuel consumption
- Preheating of the engine possible to avoid cold starts
- Robust aluminum casing, resistant to high temperature or salt

What is the new generation about?

- Steppless heating power adjustment between 1.8 and 5 kW
- Less start-stops
- Exhaust temperature sensor for more safety
- Mainswitch with blinking code (analog control)

NEW

Technical specifications

	Thermo Top Evo	Thermo Pro 50 Eco
EC approval mark	ECE R122 (Heating) E1 00 0258 ECE R10 (EMV) E1 04 5627	ECE R122 (Heating) E1 00 0334 ECE R10 (EMV) E1 03 6271
Heating power (kW)	5.0	5.0
Heating power (BTU/h)	17,100	17,100
Fuel consumption (l/h)	Diesel, 0.22 – 0.62	Diesel, 0.3 – 0.6
Fuel consumption (gal/h)	Diesel, 0.06 – 0.16	Diesel, 0.08 – 0.16
Rated voltage (V)	12	24
Rated power consumption (W)	10 – 33	28 – 46
Rated power consumption (amps)	2.7 – 3.5	1.2 – 1.9
Flow rate of circulating pump (against 0.14 bar) (l/h)	500	500
Flow rate of circulating pump (against 0.14 bar) (gal/min.)	2.2	2.2
Flow rate of circulating pump (against 0.10 bar) (l/h)	–	900
Flow rate of circulating pump (against 0.10 bar) (gal/min.)	–	4
Dimensions L x W x H (mm)	218 x 91 x 147	218 x 91 x 144
Dimensions L x W x H (inch)	8.6 x 3.6 x 5.8	8.6 x 3.6 x 5.7
Weight (kg)	2.1	2.5
Weight (lbs)	4.6	5.3

Scopes of delivery

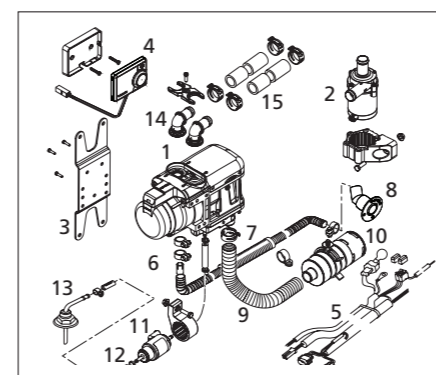

Item	SOD	Description
1	▪	Heater
2	▪	Coolant Pump U4847 with fixation
3	▪	Heater bracket
4	▪	MultiControl with bracket
5	▪	Wiring harness
6	▪	Exhaust reducer
7	▪	Exhaust silencer
8	▪	Exhaust trough hull
9	▪	Combustion air pipe
10	▪	Air Intake silencer
11	▪	Fuel pump DP42 with fixation
12	▪	Fuel hose
13	▪	Tank extracting device
14	▪	Coolant connection piece
15	▪	Coolant hose
	▪	Mounting parts

1 Order number

9038892B
Thermo Top Evo Marine 12 V Diesel

9028080D
Thermo Pro 50 Eco Marine 24 V Diesel

NEW

2 Water system

For the distribution of heat in your boat you may need extra hoses, valves, expansion tank, convectors, air handlers etc. Please compose your water system individually.

3 Fuel supply

For the installation of the heater in the engine compartment the fuel supply system has to be fire-resistant according to EN ISO 7840. Please order the adequate components additionally (fuel lines, fuel supply kit, rubber hose, fuel pump protection).

4 Exhaust system

Depending on the installation position and length of the exhaust pipe you may need a condensation water drain and an exhaust pipe insulation additionally.

5 Accessories (optional)

For extension of your heater system you find comfort control elements as well as other installation and system components in the accessories section.

Water heaters

Thermo Pro 90/Thermo Pro 90 Chiller



Thermo Pro 90 Marine – state-of-the art controller and easy service

This device is ideal for daily use: infinitely variable power adjustment, high heat output, compact dimensions, service-friendly technology and an extremely low noise level.

Thermo Pro 90 Chiller – the heater for integration into an A/C system

If you want to build a BlueComfort system with a Thermo 90 heater, use the Thermo Pro 90 Chiller version. It comes with a special electronic control unit and without the water pump which is not needed.

The advantages of the Thermo Pro 90:

- Ideal for daily use
- Infinitely variable power adjustment
- High heat output
- Compact dimensions
- Service friendly technology
- Extremely low noise level

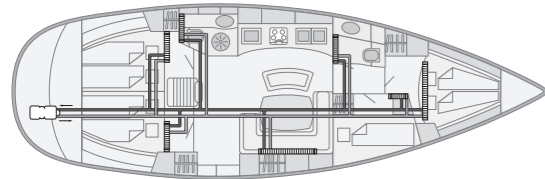

This 44' sailing yacht uses convectors for all cabins to heat the boat. Convectors are noiseless and do not consume any electrical power off the battery, therefore resulting in a very high electrical autonomy.

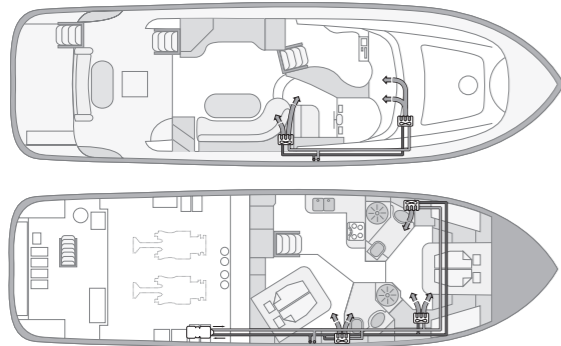

In this 40' motor yacht electrical fan blowers are used to heat up the boat. They are very compact and may be easily installed in small spaces, blowing hot air through air ducts into each cabin. The windscreen has a separate blower to demist and defrost.

Technical specifications

	Thermo Pro 90
Heating power (kW)	1.8 – 7.6 kW; boost mode 9.1
Heating power (BTU/h)	6,100 – 26,000 BTU/h; boost mode 31,000
Fuel, Fuel consumption, partial/full load/boost (l/h)	Diesel 0.18 – 1.08/1.3
Fuel, Fuel consumption, partial/full load/boost (gal/h)	Diesel 0.05 – 0.24/0.34
Rated voltage (V)	12, 24
Rated power consumption (W)	20 – 83 (90 Boost), 3.0 – 6.9 amps (7.5 Boost) at 12 V, 1.5 – 3.5 amps (3.8 Boost) at 24 V
Flow rate of circulating pump (against 0.3 bar) (l/h)	700
Flow rate of circulating pump (against 0.3 bar) (gal/min.)	3.1
Dimensions L x W x H (mm)	352 x 131 x 232
Dimensions L x W x H (inch)	13.9 x 5.2 x 9.1
Weight (kg)	5.3
Weight (lbs)	11.7

Scopes of delivery

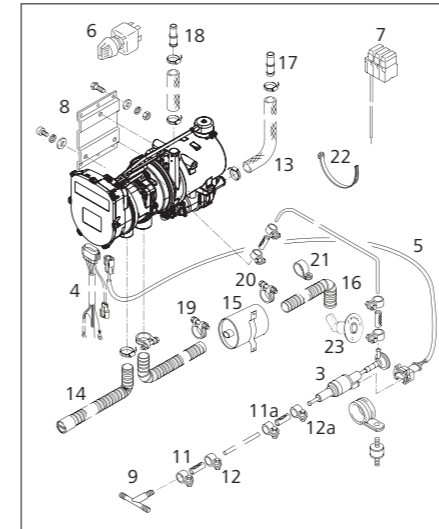

Item	Qty	Description
1	1	Heater 12 or 24 V including circulating pump and electronic control unit (no circulating pump with Thermo Pro 90 Chiller)
2	1	Electronic control unit
3	1	Metering pump
4	1	Wiring harness (heater, 570 lg)
5	1	Wiring harness (metering pump, 5,000 lg)
6	1	Switch with lamp 12 or 24 V (not with 9029942A and 9029943A)
7	1	Fuse holder with wiring harness
8	1	Heater bracket
9	1	T-piece + fuel hoses & hose clamps (8 x 5 x 8)
10	1	Hose Ø 5 x 1.5; 6,000 lg
11	4	Fuel hose Øi 4.5/Øa 10.5; 50 lg
11a	2	Fuel hose Øi 8/Øa 12; 70 lg
12	8	Hose clamp (steel; Ø 10)
12a	4	Hose clamp (steel; Ø 12)
13	1	Bent hose Øi 20 / Øa 29; 2,200 lg
14	1	Air intake silencer PAK Øi 30,5/Øa 38; 1,160 lg
15	1	Exhaust silencer Øa 38
16	1	Flexible pipe (inoxyd.) Øi 38/Øa 42; 1,600 lg (1 x 1,000 mm + 1 x 600 mm)
17	2	Connection pipe Ø 18 x 20
18	2	Connection pipe Ø 20 x 20
19	7	Hose clamp Ø 23 ... 35
20	3	Hose clamp Ø 39 ... 42
21	2	Pipe clip Ø 42
22	15	Cable tie 178 lg
23	1	Exhaust through hull

1 Order number

- 9029940C**
Thermo Pro 90 Marine 12 V Diesel
- 9029941C**
Thermo Pro 90 Marine 24 V Diesel
- 9029942C**
Thermo Pro 90 Chiller 12 V Diesel
- 9029943C**
Thermo Pro 90 Chiller 24 V Diesel

2 Water system

For the distribution of heat in your boat you may need extra hoses, valves, expansion tank, convectors, air handlers etc. Please compose your water system individually.

3 Fuel supply

For the installation of the heater in the engine compartment the fuel supply system has to be fire-resistant according to EN ISO 7840. Please order the adequate components additionally (fuel lines, fuel supply kit, rubber hose, fuel pump protection).

4 Exhaust system

Depending on the installation position and length of the exhaust pipe you may need a condensation water drain and an exhaust pipe insulation additionally.

5 Control element

Please order an adequate control element. For the Thermo Pro 90 Chiller no control element is needed. The heater is activated via the air-conditioning control.

6 Accessories (optional)

For extension of your heater system you find comfort control elements as well as other installation and system components in the accessories section.

Water heaters

Thermo Top Pro 120/150



Greater performance and innovation in terms of customer comfort & safety

The Thermo Top Pro 120 and Thermo Top Pro 150 constitute a new generation of water heaters in the high-performance categories of 12 and 15 kW. The powerful heaters are each available in 12 and 24 V versions and are ideally suited for use in marine environment.

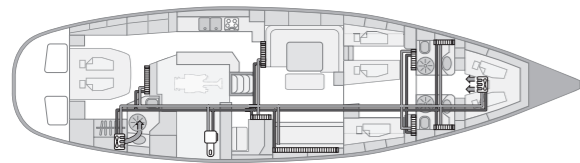

In this 64' sailing yacht the heater is installed in the technical compartment. Mainly convectors are used as heat exchangers. Fan blowers are only used in cabins with space restrictions or where quick heating up or air circulation is required.

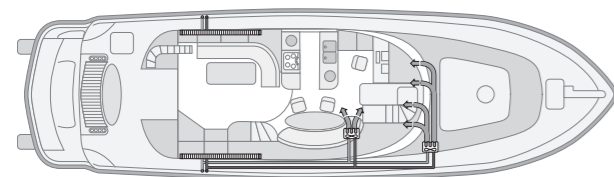

The heater in this 50' motor yacht provides heating for both decks. A combination of convectors and fan blowers is used.

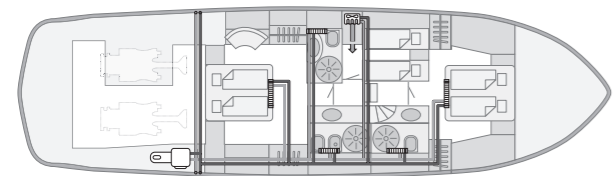

The advantages of the Thermo Top Pro 120/150:

- Small, light and lean design
- Conventional diesel fuel and 100% paraffinic diesel fuel (incl. renewable fuels, such as HVO)
- ECU and all connections on one side
- Easy to reach plugs for a fast installation
- Low noise emission
- More safety and diagnostic functions
- New, powerful coolant pump U4850

Technical specifications

	Thermo Top Pro 120	Thermo Top Pro 150
EC approval mark	E1 00 0480, E1 00 0481	E1 00 0480, E1 00 0481
Heating power (kW)	12.0	15.0
Heating power (BTU/h)	40,950	51,180
Fuel, Fuel consumption (l/h)	Diesel, 1.6	Diesel, 1.7
Fuel, Fuel consumption (gal/h)	Diesel, 0.42	Diesel, 0.45
Rated voltage (V)	12, 24	12, 24
Rated power consumption (W)	80 6.7 amps at 12 V 3.3 amps at 24 V	100 8.3 amps at 12 V 4.2 amps at 24 V
Flow rate of circulating pump (against 0.15 bar) (l/h)	1,500	1,500
Flow rate of circulating pump (against 0.15 bar) (gal/min.)	6.6	6.6
Dimensions L x W x H (mm)	470 x 200 x 200	470 x 200 x 200
Dimensions L x W x H (inch)	23 x 8.1 x 9	23 x 8.1 x 9
Weight (kg)	11.7	11.7
Weight (lbs)	25.7	25.7

Scopes of delivery

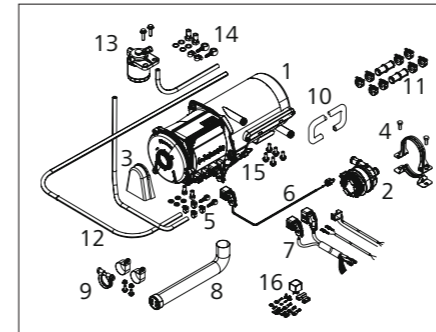

Contents Scope of delivery/Installation kit

Part	SOD	IK	Description
1	■		Heater
2	■		Coolant pump 4850
3	■		Splash guard
4	■		Bracket coolant pump
5	■		Mounting material fuel
6		■	Wiring harness coolant pump
7		■	Wiring harness vehicle, vehicle fan, fuse holder
8		■	Exhaust flex pipe*
9		■	Mounting material exhaust*
10		■	Coolant hose
11		■	Mounting material coolant
12		■	Fuel hose
13		■	Fuel filter
14		■	Mounting material fuel filter
15		■	Mounting material heater
16		■	Mounting material electric

* For marine application additional exhaust system components necessary

1

Order number

- 9035585A**
Thermo Top Pro 120, 12 V Diesel
- 9035584A**
Thermo Top Pro 120, 24 V Diesel
- 9035583A**
Thermo Top Pro 150, 12 V Diesel
- 9035582A**
Thermo Top Pro 150, 24 V Diesel

2

Installation kit

- 9035492A**
Installation kit 12 V Standard
- 9035160A**
Installation kit 24 V Standard

3

Water system

For the distribution of heat in your boat you may need extra hoses, valves, expansion tank, convectors, air handlers etc. Please compose your water system individually.

4

Fuel supply

Please compose the adequate system components for your boat individually. For the installation of the heater in the engine compartment the fuel supply system has to be fire-resistant according to EN ISO 7840.

5

Exhaust system

Please order exhaust hose, the exhaust silencer and skin fitting additionally. Depending on the installation position and length of the exhaust pipe you may need a condensation water drain and an exhaust pipe insulation additionally.

6

Accessories (optional)

For extension of your heater system you find comfort control elements as well as other installation and system components in the accessories section.

Isotemp hot water boilers



Isotemp water heaters

The Isotemp water heaters deliver high water heating performances thanks to thick insulation and smart design. Indeed, the engine water heat exchanger as well as the electrical heat element are positioned in the lowest part of the tank where the water is coldest in order to ensure an equal heating of all the water in the tank. The water in- and outlets are especially designed to minimize the mixture of cold and hot water.

Product specifications:

- Large range from 15 liter to 75 liter
- 4 product lines: Basic, Slim, Square, Spa
- Extra long, corrugated coils for high heat exchange efficiency
- Special 6.0 or 7.0 bar safety valve; simple winter drain
- Ultra-thick insulation for lowest temperature loss
- Electrical plug and play
- Immersion heating element especially designed to heat also the water at the bottom of the tank
- Thermostat mixing valve standard on Basic and Slim; optional on Square and Spa
- Immersion heating element optional available in 750; 1,200; 2,000 W; 2,000 W heating element is compatible on 230 V versions only

Isotemp Double Coil boilers are the perfect option to be integrated into Webasto water heating systems. Select among three models: Basic 24 double coil, Basic 40 double coil or Basic 75 double coil.



Basic



Slim



Spa



Square 16

Type	Order number	Volume (l)	L x diameter D (mm)	Weight (kg)	Max. pressure	Valve			Immersion heater				
						Standard safety without mixing valve	LK safety without mixing valve	LK safety with mixing valve	230 V 750 W	230 V 1200 W	230 V 2000 W	115 V 750 W	115 V 1200 W
Basic													
Basic 24	602431B000003	24	470 x 395	12.5	7	-	-	■	■	-	-	□	-
Basic 30	603031B000003	30	535 x 395	13.5	7	-	-	■	■	-	-	□	-
Basic 40	604031B000003	40	640 x 395	15.5	7	-	-	■	■	□	-	□	□
Basic 50	605031B000003	50	760 x 395	17	7	-	-	■	■	□	□	□	□
Basic 75	607531B000003	75	1,050 x 395	24.5	7	-	-	■	■	□	□	□	□
Basic Double Coil													
Basic 24 Double Coil	602431BD00003	24	470 x 395	13	7	-	-	■	■	-	-	□	-
Basic 40 Double Coil	604031BD00003	40	640 x 395	16	7	-	-	■	■	□	-	□	□
Basic 75 Double Coil	607531BD00003	75	1,050 x 395	25	7	-	-	■	■	□	□	□	□
Slim													
Slim 15	601531S000003	15	520 x 295	9	7	-	-	■	■	-	-	□	-
Slim 20	602031S000003	20	645 x 295	10.5	7	-	-	■	■	□	-	□	□
Slim 25	602531S000003	25	765 x 295	12	7	-	-	■	■	□	□	□	□
Spa													
SPA 15	6P1531SPA0100	15	450 x 310	7.5	6	■	-	-	■	-	-	□	-
SPA 15 LK MV	6P1531SPA0003	15	450 x 310	8	6	-	-	■	■	-	-	□	-
SPA 20	6P2031SPA0100	20	550 x 310	9	6	■	-	-	■	-	-	□	-
SPA 20 LK MV	6P2031SPA0003	20	550 x 310	9.5	6	-	-	■	■	-	-	□	-
SPA 25	6P2531SPA0100	25	650 x 310	10	6	■	-	-	■	□	-	□	□
SPA 25 LK MV	6P2531SPA0003	25	650 x 310	10.5	6	-	-	■	■	□	-	□	□
SPA 30	6P3031SPA0100	30	535 x 390	12	6	■	-	-	■	-	-	□	-
SPA 30 LK MV	6P3031SPA0003	30	535 x 390	12	6	-	-	■	■	-	-	□	-
SPA 40	6P4031SPA0100	40	640 x 390	14	6	■	-	-	■	□	-	□	□
SPA 40 LK MV	6P4031SPA0003	40	640 x 390	14	6	-	-	■	■	□	-	□	□
Square Dimension L x H x W (mm)													
Square 16 LK	601631QX00000	16	400 x 180 x 560	15	5	-	■	-	■	-	-	-	-
Square 16 LK MV	601631QX00003	16	400 x 180 x 560	15.5	5	-	-	■	■	-	-	-	-

■ Standard □ Optional - Not available



Accessories for heating systems

Circulating pumps	40
Control elements	41
Combustion air system	44
Exhaust system	46
Fuel supply	49
Warm air system	51
Blower heat exchangers	57
Water system	59
Mounting parts	64
Electrical accessories	68
Service and diagnosis	69

Circulating pumps

Technical features

These circulating pumps are suitable for hot water circulation. They are not designed for sea water use.

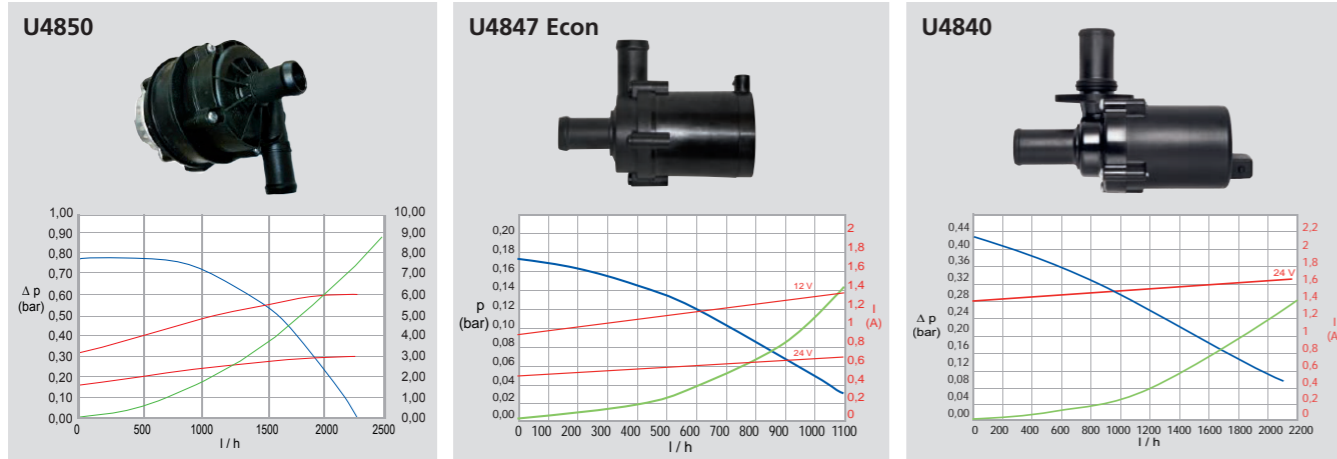

Volume flow with water/glycol mixture (50:50) 20 °C







Flow resistance when the pump is stationary

Rated power consumption

Technical data

Model overview	U4850	U4847 Econ	U4840
Nominal voltage (V)	12/24		
Max rated power consumption (W)	67	28	29
Volume flow (l/h)	1,500 (against 0.56 bar)	500 (against 0.14 bar)	700 (against 0.34 bar)
Dimensions L x W x H (mm)	118 x 80 x 80	95 x 65 x 85 (130° connection piece)	134 x 53 x 90
Water connection, Ø (mm)	20		
Weight (kg)	0.66	0.3	0.4
Pump model	Kit U4850 incl. fastening material	U4847 Econ	U4840
Order number 12 V	Included SOD Thermo Top Pro 120/150	9002514B	1321930A
Order number 24 V	Included SOD Thermo Top Pro 120/150	98237B	1321932A

Control elements

	Air Top 2000 STC	Air Top Evo 40/55	Thermo Top Evo	Thermo Pro 50 Eco	Thermo Pro 90	Thermo Top Pro 120/150	Order number
	Rotary selector switch Standard						
12/24 V – With switch function and light – Cover panel Ø 49 mm – Installation depth including plug: 55 mm	■	■					1322581A
	Installation cover panel with switch for heating and ventilation mode						
– For rotary selector switch 1322581A – Black plastic		■					92240A
	Adapter cable ventilation						
Additional adapter cable harness ventilation for Evo heaters		■					1320829A
	Kit MultiControl Mar RV ATE						
Suitable for permanent heating	■	■					9030910E
	Kit MultiControl Mar RV TT						
Suitable for permanent heating			■	■	■	■	9030911D
	MultiControl holding frame						
– Fastened by screws at the mounting point – MultiControl is clicked into the holding frame	■	■	■	■	■	■	9030077A





■ All listed water heaters can be controlled with Multi Control.

Control elements

	Air Top 2000 STC	Air Top Evo 40/55	Thermo Top Evo	Thermo Pro 50 Eco	Thermo Pro 90	Thermo Top Pro 120/150	Order number
 <p>Kit UniControl W-bus compatible Webasto air- and water heaters – 12/24 V – Downward compatible with pre-selection timer 1531 – Quick start button – Switch input (for analog push button) – Instrument lighting (K1.58) – Ignition plus (terminal 15, for ad hoc continuous heating) – ADR Including wiring harness adapter (10 PIN to 4 PIN) UniControl – 9034555A</p>	■	■	■	■	■	■	9034520C
 <p>Kit UniControl 1531 W-bus compatible Webasto air- and water heaters – 12/24 V – Downward compatible with pre-selection timer 1531 – Quick start button – Switch input (for analog push button) – Instrument lighting (terminal 58) – Ignition plus (terminal 15, for ad hoc continuous heating) – ADR Including adapter cable (10 PIN to 12 PIN) timer 1531 – 9034596A</p>	■	■	■	■	■	■	9034521C
 <p>Wiring harness adapter UniControl Connection cable UniControl – 10-pole (UniControl) to 4-pole standard plug – Cable length 0.13 m</p>	■	■	■	■	■	■	9034555A
 <p>Adapter cable timer 1531 Adapter cable for replacement of pre-selection timer 1531 – 10-pole (UniControl) to 12-pole connector of preselection timer 1531 – Cable length 0.2 m</p>	■	■	■	■	■	■	9034596A
 <p>Expansion kit UniControl Expansion cable for additional wiring (e.g. switching input, terminal 15) – 5 single wires with one-sided crimped flat connector – Flat connectors can be pinned into the still vacant slots of the 10-pole UniControl plug – Including 5 butt connectors – Cable length 3 m</p>	■	■	■	■	■	■	9034597A
 <p>Installation frame kit, short – For UniControl, standard/combination digital timer and space thermostat, 3 position controller – Suitable for Unitimer – With installation materials</p>	■	■	■	■	■	■	474630
 <p>Installation kit, long – For UniControl, standard/combination digital timer and space thermostat, 3 position controller – With installation materials</p>	■	■	■	■	■	■	476404

■ All listed water heaters can be controlled with Multi Control.

Control elements

	Air Top 2000 STC	Air Top Evo 40/55	Thermo Top Evo	Thermo Pro 50 Eco	Thermo Pro 90	Thermo Top Pro 120/150	Order number
 <p>Remote control Telestart T91 Holiday with continuous heating function 12 V – With check-back signal. Incl. 1 handheld transmitter with battery, receiver, self-adhesive window antenna and Y adapter</p>			■	■	■	■	9018150C
 <p>Telestart T 100 HTM radio remote control – Including 1 hand-held transmitter with battery, receiver, self-adhesive window antenna, ESV adapter and temperature sensor HTM – Automatic heating time calculation</p>	■	■	■	■	■	■	1314637A
 <p>ThermoConnect NEW – Control your heater from anywhere – Departure time-based heating – Custom programming for individual or frequent heating processes – Choice between heating and ventilation – Control of multiple boats – Interior temperature display – Battery charge check – Boat position can be located – Geofencing: alerts customer when Thermo Connect leaves a defined geographical area – Location Based Events (IFTTT) – Can be linked to smart home systems (Alexa compatible)</p>	■	■	■	■	■	■	9040223A
 <p>Rocker switch ON / OFF – 12/24 V – Dimensions: 23 x 23 mm (drilling hole 20 mm) – LED to indicate heater operation – Incl. wiring harness and information sheet with installation notes</p>			■	■	■	■	9032550A

* Connection adaptation on request.

Combustion air system

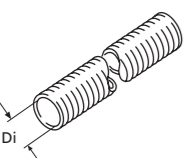
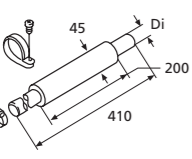
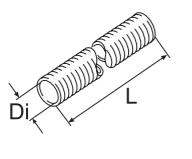
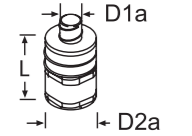
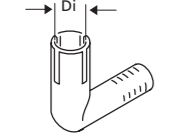
	Air Top 2000 STC	Air Top Evo 40/55	Thermo Top Evo	Thermo Pro 50 Eco	Thermo Pro 90	Thermo Top Pro 120/150	Order number
	Flexible pipe						
				■			Di = 18, L = 1,000, APGA-A 1319593A
	■	■					Di = 22, L = 20,000, PAK 1321565A
		■					Di = 25, L = 5,000, PAK 1321587A
				■			Di = 30, L = 5,000, PAK 1321557A
	Air intake silencer, set						
	■						Di = 22, L = 410, with mounting parts 1313514A
	Air intake silencer						
	■						Di = 22, L = 800, PAK, without penetration protection cap 1322455A
		■					Di = 25, L = 650, AK/PAKL, with penetration protection cap 1319924A
				■			Di = 30, L = 1,160, PAK/PAKL, without penetration protection cap 1319607A
	Air intake silencer						
			■				D1a = 24, D2a = 52, L = 138, plastic, complete with 300 mm flexible pipe, D1a = 24 mm 9025956A
	Combustion air elbow						
		■					Di = 22 1320144A
			■				Di = 25 1320278A
							Plastic

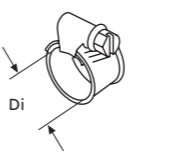
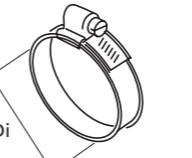
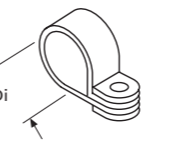

Combustion air system

	Air Top 2000 STC	Air Top Evo 40/55	Thermo Top Evo	Thermo Pro 50 Eco	Thermo Pro 90	Thermo Top Pro 120/150	Order number
	Hose clamp						
		■		■	■		Di = 16 ... 27, 10 pieces 9015918A
			■			■	Di = 23 ... 35, 20 pieces 1320271A
							W = 9, SW = 7, stainless steel, bolt head with hexagon and slot
	Hose clamp						
						■	Di = 40 ... 47 1320158A
							SW = 8, W = 14.3, steel corrosion-resistant, bolt head with hexagon and cross-head slot
	Pipe clip						
		■			■		Di = 25, W = 15, stainless steel 1320045A
			■				Di = 29, W = 15, steel zinc coated/rubber, rubber-coated pipe clip, fastening hole 6.4 mm, 5 pieces 1320235A
					■		Di = 33, W = 15, stainless steel, 6.5 mm fastening hole 1320064A

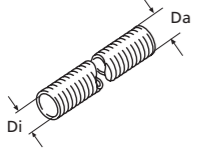
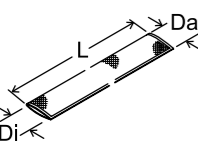
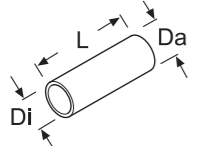
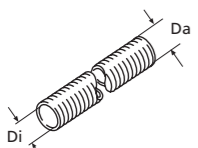
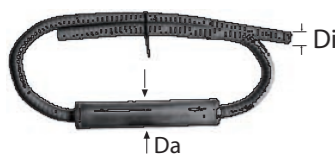
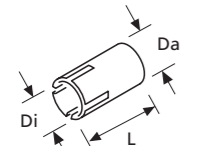
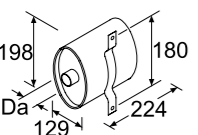

Exhaust system

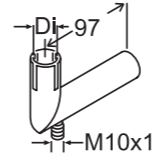
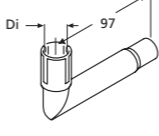
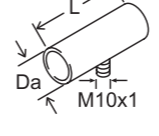
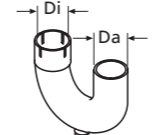
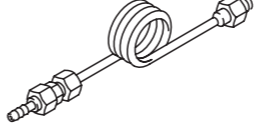
	Air Top 2000 STC	Air Top Evo 40/55	Thermo Top Evo	Thermo Pro 50 Eco	Thermo Pro 90	Thermo Top Pro 120/150	Order number
 <p>Flexible exhaust pipe (INOX), two-ply</p> <p>Di = 22, Da = 26, L = 1,000 with end cap</p> <p>Di = 24, Da = 28, L = 10,000</p> <p>Di = 38, Da = 41, L = 5,000</p> <p>Di = 41, Da = 38, L = 10,000</p> <p>Di = 38, Da = 41, L = 20,000</p> <p>Stainless steel</p>							1322414A
							1321523A
							1321540A
							1321541A
							1321539A
 <p>Heat protection hose</p> <p>Di = 70, L = 1,250</p> <p>Di = 72, L = 1,700</p> <p>Di = 70, L = 1,850</p> <p>Da = 120, fiberglass</p>							9016230B
							9016231B
							1320830A
 <p>Flexible heat protection pipe</p> <p>Di = 28, Da = 32.5, GA-A (aluminium foil and aluminium coated glass fabric)</p> <p>Di = 45, Da = 48.5, GA2-A (aluminium and aluminium coated glass fabric)</p> <p>L = 10,000</p>							1321601A
							1321602C
 <p>Flexible heat protection pipe</p> <p>Di = 28, Da = 38, L = 324, with cover, non-flammable, interior resistant to temperatures up to 500 °C</p>							1319670A
 <p>Exhaust muffler</p> <p>Di = 24, L = 1,800</p> <p>Di = 38, L = 1,000</p> <p>Outside with partial fiberglass insulation</p>							1322001A
							1321823A
 <p>Exhaust gas reducing bush</p> <p>Di = 22, Da = 24, L = 40, stainless steel</p>							1320382A
 <p>Exhaust silencer</p> <p>Da = 38, L = 270, W = 130, stainless steel</p>							1321397A



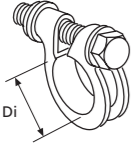
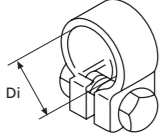

Exhaust system

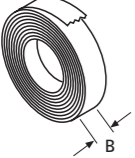
	Air Top 2000 STC	Air Top Evo 40/55	Thermo Top Evo	Thermo Pro 50 Eco	Thermo Pro 90	Thermo Top Pro 120/150	Order number
 <p>Insulation sleeve for exhaust silencer</p> <p>Glas fiber heat protection, 550 x 440 mm, with snap fastener, for part 1321397A</p>							9028104A
 <p>Elbow</p> <p>Di = 24, L = 110, stainless steel, with condensation water drain</p>							1320378A
 <p>Elbow</p> <p>Di = 24, L = 110, stainless steel, without condensation water drain</p>							1320383A
 <p>Connection pipe</p> <p>Da = 24, L = 50, M6, stainless steel, without condensation water drain</p> <p>Da = 24, L = 65, steel, with anti-corrosion protection and condensate drain</p> <p>Da = 38, L = 65, stainless steel, for exhaust muffler 1320841A and 1320895A, with condensation water drain</p>							1319937A
							1319935A
							1320959A
 <p>Exhaust pipe</p> <p>Di = 38, Da = 38, stainless steel</p>							1319380A
 <p>Condensation water drain</p> <p>L = 128, M10 x 1 connection thread, copper, for exhaust connecting pipe 1319935A, with mounting parts</p>							92621A
 <p>Through hull double walled straight</p> <p>Da = 24</p> <p>Da = 38</p> <p>Da = 70</p> <p>Stainless steel</p>							1320363A
							1320983A
							3393270A
 <p>Through hull double walled bended</p> <p>Da = 24</p> <p>Da = 38</p> <p>Stainless steel</p>							1320364A
							1320365A

Exhaust system

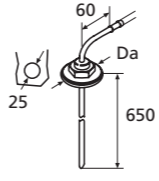
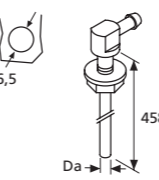
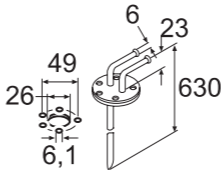
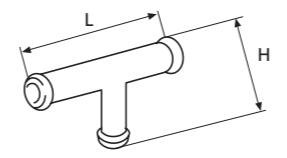
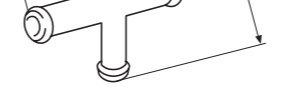
	Air Top 2000 STC	Air Top Evo 40/55	Thermo Top Evo	Thermo Pro 50 Eco	Thermo Pro 90	Thermo Top Pro 120/150	Order number
 <p>Hose clamp Di = 39 ... 42, W = 13.5, thread M8, steel corrosion-resistant, for flexible exhaust pipe, with screw</p>					■	■	1320194A
 <p>Hose clamp Di = 24 ... 26, with carriage bolt</p>	■		■	■			1320165A
 <p>Di = 26 ... 28, nut, welded W = 16, thread M6, stainless steel, for flexible exhaust pipe</p>		■					1320220A
 <p>Insulating lagging L = 50,000, W = 60, E-glass, white, usage temperature 450°C, 550°C for short periods, 2 mm thick</p>	■	■	■	■	■	■	1320357A

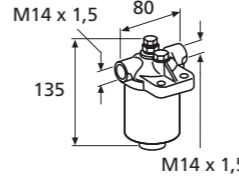

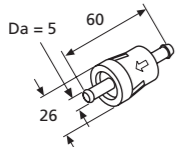
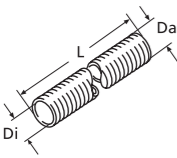
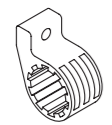
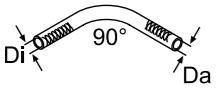

Fuel supply

	Air Top 2000 STC	Air Top Evo 40/55	Thermo Top Evo	Thermo Pro 50 Eco	Thermo Pro 90	Thermo Top Pro 120/150	Order number
 <p>Tank extracting device, riser pipe Di = 2.6, Da = 5 Da = 8 L = 650, steel zinc coated, 90° extractor connection piece, only for installation in metal tanks</p>					■	■	1320399A
 <p>Tank extracting device, riser pipe Di = 2.5, Da = 5, L = 409, thread M6, stainless steel, 90° extractor connection piece for mounting in tank fitting, suitable for plastic tank and metal tank</p>	■	■	■	■		■	1322632A
 <p>Tank extracting device, riser pipe Da = 6, L = 630, steel zinc coated, with sealing</p>						■	1322830B
 <p>Fuel extractor, T-piece L = 50, H = 26, 6 x 5 x 6 L = 50, H = 28, 8 x 5 x 8 L = 50, H = 28, 8 x 6 x 8 Copper</p>	■	■	■	■	■		1319300A
 <p>L = 50, H = 28, 8 x 5 x 8</p>	■	■	■	■	■		1319301A
 <p>L = 50, H = 28, 8 x 6 x 8</p>						■	1320531A
 <p>Holder with housing for interchangeable filter L = 135, H = 80, M14 x 1.5 connection thread, light metal</p>						■	1319291A
 <p>Interchangeable filter For holder 1319291A</p>						■	1320031A

Fuel supply

	Air Top 2000 STC	Air Top Evo 40/55	Thermo Top Evo	Thermo Pro 50 Eco	Thermo Pro 90	Thermo Top Pro 120/150	Order number
Connecting parts (bag) Steel zinc coated, for soldered joints. Contents: double connection piece, union nuts, ring seals and sealing cone						■	1320539A
 Fuel filter Da = 5, plastic, transparent	■	■	■	■	■		1319466A
 Flexible heat protection pipe L = 20,000 L = 5,000 Di = 14.5, Da = 16.5, GA-A (aluminium foil and aluminium coated glass fabric)	■	■	■	■	■	■	1321584B 1321585B
 Dosing pump mounting Very quiet mounting, bag of 1 piece	■	■	■		■		1320193A
 Fuel line decoupling kit Di = 4.5, Da = 10.5, bag with two 90° elbows	■	■					9026570B

Fuel supply systems which are installed in the engine room of a boat need to be fire resistant according to EN ISO 7840. Please select the required parts from the items listed below.

 Mini Jacket fuel pump protector Protection device for fuel pumps with mufflers, required by ISO 7840 if the fuel system is installed in engine rooms	■					■	1319522A
 Metal fuel line kit for boats Di = 2.0, Da = 5, L = 5,000, EN ISO 7840, with screw fasteners, hoses and clips	■	■	■	■	■		66958B
 Fuel line for boats Di = 2.0, Da = 5, L = 5,000, stainless steel	■	■	■	■	■		1320860A
 Fuel hose for boats Di = 5, Da = 15, L = 50	■	■	■	■	■		1320857A

Warm air system

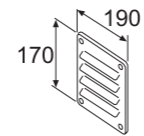
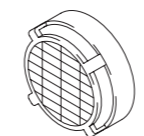
	Air Top 2000 STC	Air Top Evo 40/55	Order number
 Air Intake Louvre plate L = 190, H = 170, aluminium	■	■	1319269A
 Screen Di = 60, plastic, black, for intake and outlet openings of heater Di = 90	■	■	1320163A 1310581A

Ducting

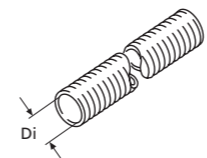
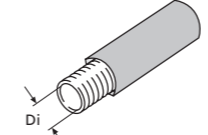
 Flexible pipe			
Di = 60, L = 25,000 APK, black	■	■	1311892C
Di = 60, L = 10,000 APK, black	■	■	1322083C
Di = 60, L = 2,000 APK, black	■	■	1321574B
Di = 60, L = 5,000 APK, black	■	■	1321575C
Di = 80, L = 25,000 APK, black		■	1311893C
Di = 80, L = 10,000 APK, black		■	1321718C
Di = 80, L = 2,000 APK, black		■	1321576C
Di = 80, L = 5,000 APK, black		■	1321577B
Di = 90, L = 25,000 APK, black		■	1311894C
Di = 90, L = 10,000 APK, black		■	1321719C
Di = 90, L = 2,000 APK, black		■	1321578C
Di = 90, L = 5,000 APK, black		■	1321579C
Di = 60, L = 3,000 PAHK, black	■	■	1321511A
Di = 60, L = 25,000, PAKP, grey	■	■	1311898C
Di = 60, L = 10,000, PAKP, grey	■	■	1321727C
Di = 60, L = 2,000, PAKP, grey	■	■	1321504A
Di = 60, L = 5,000, PAKP, grey	■	■	1321505A
Di = 80, L = 25,000, PAKP, grey		■	1311900C
Di = 80, L = 10,000, PAKP, grey		■	1321729B
Di = 80, L = 2,000, PAKP, grey		■	1321582B
Di = 80, L = 5,000, PAKP, grey		■	1321583B
Di = 80, L = 10,000, PAK, black		■	1322147B
Di = 90, L = 25,000, PAKP, grey		■	1311902C
Di = 90, L = 10,000, PAKP, grey		■	1321731C
Di = 90, L = 2,000, PAKP, grey		■	1321506B
Di = 90, L = 5,000, PAKP, grey		■	1321508A
 Insulated hoses			
Di = 80		■	1321515A
Di = 90		■	1321517A
L = 12,000, PAK			

Hose specification

APK: Aluminium, Paper, Plastic – black, with white Webasto logo

PAHK: Paper, Aluminium, High rigidity Aluminium, Plastic – black, with white Webasto logo

PAK: Paper, Aluminium, Plastic – black, with white Webasto logo

PAPK: Paper, Aluminium, Paper, Plastic – grey, with red and blue Webasto logo, extra strong 4 layer design

Warm air system

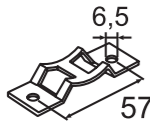
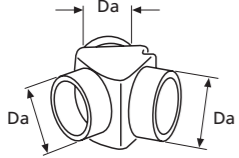
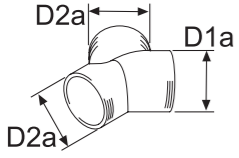
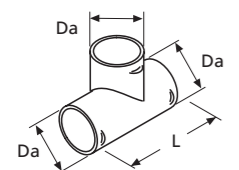
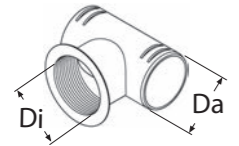
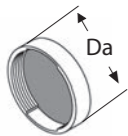
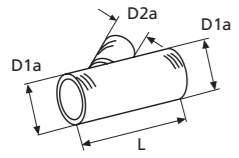
		Air Top 2000 STC	Air Top Evo 40/55	Order number
Ducting				
	Console For mounting flexible pipes with corresponding hose clip	■	■	1321044A
Distributor				
	Distributor Y-unit Da = 55 Da = 80 Plastic, black	■	■	1319416A 1319212A
	Distributor Y-unit D1a = 80, D2a = 55, to be used in the secondary flow only D1a = 60, D2a = 60 D1a = 90, D2a = 80 D1a = 90, D2a = 90 D1a = 80, D2a = 60 Plastic, black	■	■	1320753A 1320814A 1320375A 1320470A 1320471A
	T-unit Da = 60 Da = 90 L = 110, 90°, plastic, black	■	■	1320474A 1320473A
	T-unit Di = 60, Da = 60, 90°, with thread Di = 60, Da = 90, 90°, with thread Plastic, black	■	■	1320476A 1320475A
	End Cap Da = 60 Da = 90 Plastic, black	■	■	1320477A 1319870A
	Junction fitting D1a = 60, L = 145 D1a = 90, L = 146 D2a = 60, 45°, plastic, black	■	■	1320472A 1320707A

Warm air system

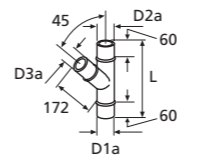
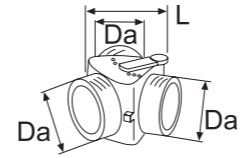
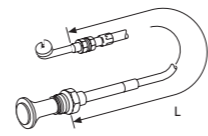
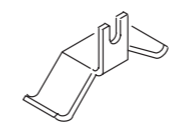
		Air Top 2000 STC	Air Top Evo 40/55	Order number
	Junction fitting D1a = 80, D2a = 60, D3a = 60, L = 350, to be used in the secondary flow only! D1a = 80, D2a = 80, D3a = 60, L = 350 D1a = 80, D2a = 80, D3a = 80, L = 370, 45°, steel corrosion-resistant	■	■	1319314A 1320645A 1319315A
	Distributor Da = 55, L = 95 Da = 80, L = 124 Plastic, black, with remote control flap valve	■	■	1319224A 1319214A
	Control cable L = 850 L = 1,500 For Distributor 1319224A und 1319214A, with grip and outer sleeve	■	■	1320785A 1320786A
	Clamp For Bowden Cable 1320785A und 1320786A	■	■	1319688A

Quick-fit Hot Air Ducting System (HADS):

- High temperature resistance from -40°C up to +140°C
- PA6.6 GF30 glass fibre reinforced synthetic material
- Super easy fitting, no need for tools or screws
- Multiple combination possibilities to suit any application

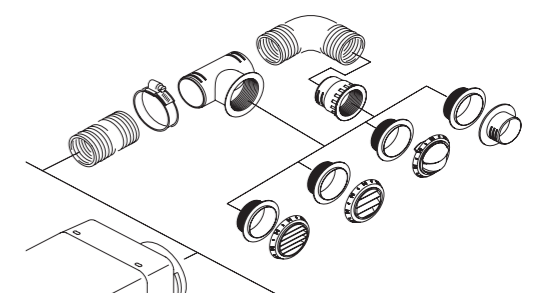

Webasto provides perfectly fitting, high quality components for an easy installation and high flexibility.

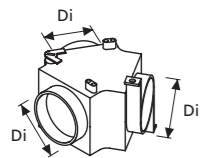
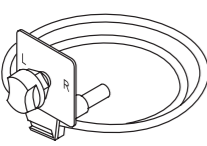

Warm air system

		Air Top 2000 STC	Air Top Evo 40/55	Order number
	Distributor			
	Di = 60	■	■	1320352A
	Di = 90		■	1320926A
Plastic, black, with control butterfly valve				
	Control device for distributor			
	L = 2,000, for Distributor 1320352A and 1320926A	■	■	1319868A

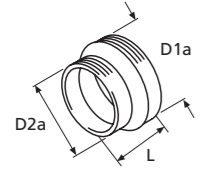
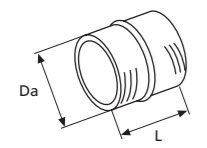

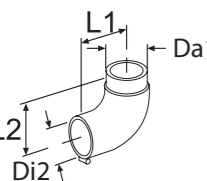
Adaptors

	Reducer for air hose			
	D1a = 60, D2a = 55, L = 35		■	1320127A
	D1a = 90, D2a = 80, L = 45		■	1320185A
	D1a = 80, D2a = 55, L = 82		■	1319477A
Plastic, black, for flexible pipe				
	Hose connector			
	Da = 55, L = 55	■	■	1319473A
	Da = 60, L = 50	■	■	1320469A
	Da = 80, L = 75		■	1319476A
	Da = 90, L = 50		■	1319869A
Synthetic material				
	Reduction adapter			
	Da = 60		■	1320760A
Da = 80		■	1320925A	
Di = 90, plastic, black				
	Elbow			
	Da = 90, 90°, plastic, black		■	1320706A
	Elbow			
	Di2 = 80.5, Da1 = 79, L1 = 115, L2 = 120, 90°, steel corrosion-resistant		■	1319272A

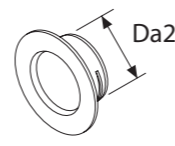
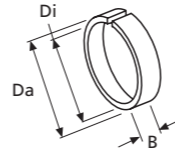
Warm air system

		Air Top 2000 STC	Air Top Evo 40/55	Order number
	Wall feed-through			
	Da = 60	■	■	1320923A
	Da = 90		■	1320924A
Plastic, black				
	Adaptor ring			
	Di = 55, Da = 60, for outlet 1320812A	■	■	1320224A
	Di = 70, Da = 80, for outlet 1319946A		■	1320040A
	W = 17, plastic, black			

Outlets

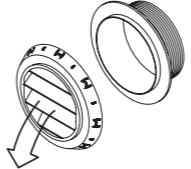
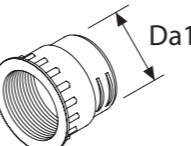
	Air Outlet, closeable			
	Da = 60, black	■	■	1320206A
	Da = 60, white	■	■	1320207A
	Da = 60, grey	■	■	1320937A
	Da = 90, black		■	1320355A
	Da = 90, white		■	1320713A
	Da = 90, grey		■	1320714A
	L = 30, plastic, outlet closeable, bag with wall feed through			
	Air Outlet			
	Da = 60, black	■	■	1320934A
	Da = 60, white	■	■	1320935A
	Da = 60, grey	■	■	1320936A
	Da = 90, black		■	1320932A
	Da = 90, white		■	1320711A
	Da = 90, grey		■	1320712A
	L = 30, plastic, straight air flow, bag with wall feed through			
	Air outlet, 45°			
	Da = 60, black	■	■	1320204A
	Da = 60, white	■	■	1320205A
	Da = 60, grey	■	■	1320933A
	Da = 90, black		■	1320709A
	Da = 90, white		■	1320710A
	Da = 90, grey		■	1320354A
	L = 30, plastic, 45°, bag with wall feed through			
	Union nut for outlet			
	Da = 60	■	■	1320922A
	Da = 90		■	1320468A
L = 60, plastic, black				

Warm air system

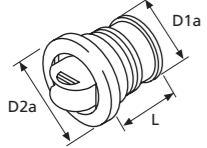
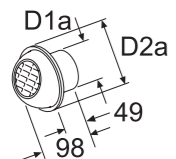
		Air Top 2000 STC	Air Top Evo 40/55	Order number
	Air outlet			
	D1a = 55	■		1320812A
	D1a = 70, use for secondary flow only		■	1319946A
	D2a = 100, L = 65, plastic, black, closable, with bushing			
	Air outlet			
	D1a = 60, D2a = 92	■		1322405A

Silencer

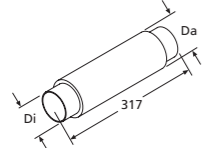
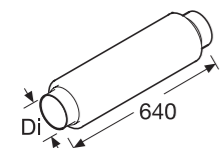
	Air ducting silencer			
	Di = 90, Da = 122, L = 317, plastic		■	1320996A
	Air ducting silencer			
	Di = 90, L = 600, aluminium/plastic		■	1321734A

Blower heat exchangers

The blower modules are the ideal combination for Webasto water heaters. Thanks to their powerful blowers, the cabins of boats and yachts can be heated up quickly. Most models have an adjustable blower speed to fine-tune the air flow according to individual needs. In addition to their compact dimensions they ensure an easy installation.

The product range



Florida 3 – extra-silent single speed 3 kW model with very low power consumption



Florida 5 – Compact 3-speed 5 kW model with blower speed and heat output regulation



Florida 5 – Compact 3-speed 5 kW model without controls

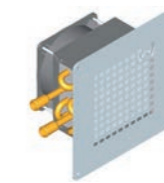

Whisperer – Very compact and silent 1.8 kW model with single speed axial fan



Madeira 4 – Lightweight and variable 4 kW model, 3 blower speeds, choice of air outlet



Madeira 8 – Lightweight and variable 7,3 kW model, 3 blower speeds, choice of air outlet



BB4 – Compact 2,5 kW model with 3-speed blower regulation and metal casing



BB8 – Powerful 8 kW model with 3-speed blower regulation and robust metal casing

Blower speed control

The blower speed control is the perfect match for all blower heat exchangers. It provides temperature regulated automatic blower speed control or manual 5-speed blower regulation. With a variable temperature setting, everybody can find his perfect comfort climate.



Scopes of delivery

- Control element
- Electronic PWM module
- Temperature sensor (5 meters)

Blower speed control – temperature-regulated blower speed control for the blower modules Florida 5 without controls, BB4, BB8. With separate mounting also possible for Madeira 4 and Madeira 8.

Blower heat exchangers

Model	Order number	Colour	Voltage (V)	Heat output at Q100 (kW)	Air flow at free discharge (m ³ /h)	Water connection diam. (mm)	Electrical power consumption (W)	Dimensions W x H x D (mm)	Weight (kg)
Florida 3 No Noise	3200740A	light grey	12	3	120	16	12	269 x 198 x 141	1.4
	3200741A	light grey	24	3	120	16	12	269 x 198 x 141	1.4
Florida 5 with controls	3200679A	light grey	12	5.2	285	16	120	269 x 198 x 218	2
	3200680A	light grey	24	5.2	285	16	120	269 x 198 x 218	2
Florida 5 without controls	3200681A	light grey	12	5.2	285	16	120	269 x 198 x 218	2
	3200682A	light grey	24	5.2	285	16	120	269 x 198 x 218	2
Whisperer	3200673A	Inox (front)	12	1.8	120	16	8.4	210 x 210 x 125	1.2
	3200674A	Inox (front)	24	1.8	120	16	8.4	210 x 210 x 125	1.2
BB4	71174000	blue	12	2.5	190	16	38	310 x 150 x 150	3.5
	71174500	blue	24	2.5	190	16	38	310 x 150 x 150	3.5
BB8	3395977A	blue	12	8	525	16	65	480 x 170 x 305	12
	3395978A	blue	24	8	525	16	65	480 x 170 x 305	12
Madeira 4	71174550	light grey and dark grey	12	4.6	200	16	70	275 x 115 x 203	1.8
	71174552	light grey and dark grey	24	4.6	200	16	70	275 x 115 x 203	1.8
Madeira 8	71174554	light grey and dark grey	12	7.3	300	16	150	376 x 115 x 250	3.1
	71174556	light grey and dark grey	24	7.3	300	16	150	376 x 115 x 250	3.1
Outlet versions									
Air grille 90 x 90 mm*	3396524A	black							
Air hose connector diam. 55 mm*	3396525A	black							
* When ordering the Madeira 4 or Madeira 8, please specify the type and amount of desired air outlets. Madeira 4 requires 2 and Madeira 8 requires 4 outlets.									
Control elements									
Blower speed control	3391288B		12/24					123 x 80 x 40	0.4

* Please refer to pictures of Madeira 4 and Madeira 8 for example of air grille and hose connectors, see previous page.

Water system



Accessories: Water system

Webasto offers a wide range of high-quality Hep₂O products.

- Cabling ability – Hep₂O provides faster, safer and more cost effective installation
- Less jointing – Hep₂O flexible polybutylene pipe system requires less jointing, thus saves time and materials
- Joint security – the Hep₂O push-fit piping offers reliable jointing and safe assembly
- High resistance to impact and vibration – solder free, and the Hep₂O system is extremely strong and resistant to denting and accidental damage from impact or vibration
- Corrosion free – Hep₂O completely eliminates electrolytic corrosion and is highly resistant against aggressive salt-water and other corrosive media

For the complete overview of Hep₂O parts please refer to the water system section for BlueCool accessories in this catalog.

Water system

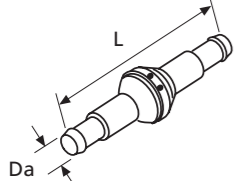
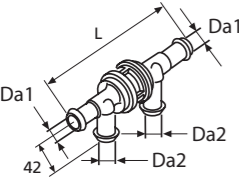
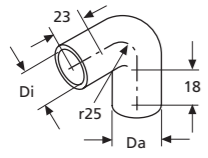
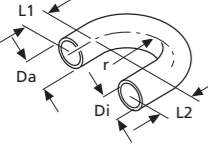
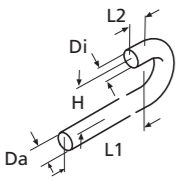
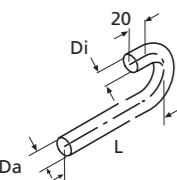
		Thermo Top Evo	Thermo Pro 50 Eco	Thermo Pro 90	Thermo Top Pro 120/150	Order number
	Check valve					
	Da = 15, L = 104	■	■	■	■	1320240A
	Da = 15, L = 104	■	■	■	■	1320239A
	Da = 18, L = 90	■	■	■	■	1319250A
	Da = 18, L = 100	■	■	■	■	1319484A
	Plastic, without leak hole					
	Check valve					
	D1a = 18, D2a = 18, L = 146, plastic, black, with leak hole	■	■	■	■	1319486A
	D1a = 20, D2a = 20, L = 162, brass, with leak hole	■	■	■	■	1319595A
	D1a = 18, D2a = 18, L = 146, plastic, black, without leak hole	■	■	■	■	1319485A
	H = 42					
	Molded hose					
	Di = 18, Da = 25, 90°	■	■	■	■	1319418A
	Molded hose					
	Di = 18, Da = 25, r = 25, L1 = 18, L2 = 18	■	■	■	■	1319401A
	Di = 20, Da = 27, r = 23.5, L1 = 88, L2 = 64	■	■	■	■	1319623A
	180°					
	Molded hose					
	Di = 15, Da = 25, L1 = 580, L2 = 17, H = 75, 180°	■	■	■	■	1320790A
	Di = 18, Da = 25, L1 = 580, 180°	■	■	■	■	1319421A
	Di = 18, Da = 25, L1 = 1,100, L2 = 17, H = 75	■	■	■	■	1322496A
	Di = 20, Da = 29, L1 = 89, L2 = 20, H = 98	■	■	■	■	1319761A
	Molded hose					
	Di = 18, Da = 25, L = 110	■	■	■	■	1322493A
	Di = 20, Da = 27, L = 70	■	■	■	■	1321031A
	Di = 20, Da = 27, L = 190	■	■	■	■	1322473A

Water system

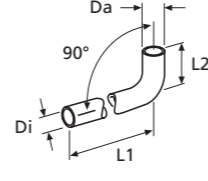
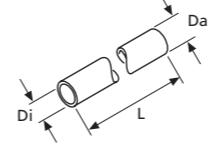
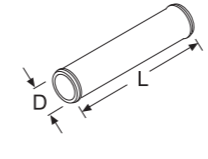
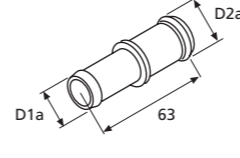
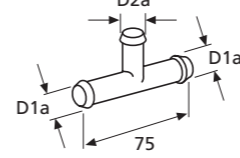
		Thermo Top Evo	Thermo Pro 50 Eco	Thermo Pro 90	Thermo Top Pro 120/150	Order number	
	Molded hose						
	Di = 15, Da = 22, L1 = 1,020, L2 = 50	■	■	■	■	1320789A	
	Di = 18, Da = 25, L1 = 125, L2 = 90	■	■	■	■	1320907A	
	Di = 18, Da = 25, L1 = 500, L2 = 48	■	■	■	■	1319953A	
	Di = 18, Da = 27, L1 = 1,020, L2 = 50	■	■	■	■	1320794A	
	Di = 20, Da = 27, L1 = 70, L2 = 57	■	■	■	■	1319839A	
	Di = 20, Da = 27, L1 = 130, L2 = 57	■	■	■	■	1320147A	
	Di = 20, Da = 27, L1 = 187, L2 = 47	■	■	■	■	1319952A	
	Di = 20, Da = 27, L1 = 360, L2 = 47	■	■	■	■	1320961A	
	Di = 20, Da = 27, L1 = 615, L2 = 57	■	■	■	■	1320197A	
	Di = 22, Da = 29, L1 = 225, L2 = 57	■	■	■	■	1320911A	
	Di = 22, Da = 29, L1 = 1,020, L2 = 50	■	■	■	■	1320842A	
		90°					
		Hose					
Di = 15, Da = 22, L = 2,400		■	■	■	■	1320300A	
Di = 18, Da = 25, L = 58		■	■	■	■	1321789A	
Di = 18, Da = 27, L = 2,000		■	■	■	■	1319379A	
Di = 20, Da = 27, L = 380		■	■	■	■	1320960A	
	Connecting pipe						
	D = 15, L = 75 Brass	■	■	■	■	1319279A	
	Connecting pipe						
	D1a = 15, D2a = 20	■	■	■	■	1321000A	
	D1a = 17, D2a = 20, L = 63	■	■	■	■	1320143A	
	D1a = 18, D2a = 18	■	■	■	■	9006211A	
	D1a = 18, D2a = 20	■	■	■	■	9005819C	
	D1a = 18, D2a = 22, L = 63	■	■	■	■	1320155A	
	D1a = 20, D2a = 20	■	■	■	■	1320342A	
	D1a = 20, D2a = 22, L = 63	■	■	■	■	1319594A	
	Black, plastic						
	T-piece						
	D1a = 15, D2a = 15, steel corrosion-resistant	■	■	■	■	1319289A	
	D1a = 18, D2a = 15, steel corrosion-resistant	■	■	■	■	1320532A	
	D1a = 18, D2a = 18, plastic, black	■	■	■	■	1321001A	
	D1a = 20, D2a = 10, steel corrosion-resistant	■	■	■	■	1319846A	
	D1a = 20, D2a = 15, steel corrosion-resistant	■	■	■	■	1319290A	
	D1a = 20, D2a = 20, brass	■	■	■	■	1319602A	
	L = 75						

Water system

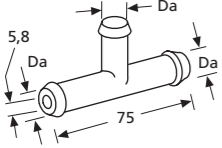
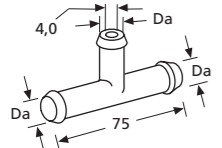
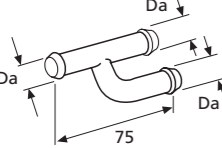
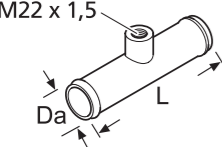
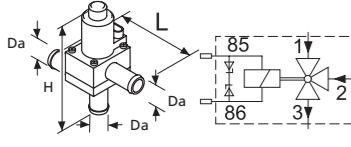
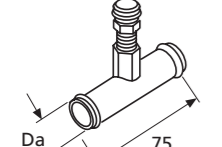
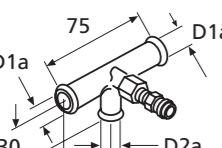
	Thermo Top Evo	Thermo Pro 50 Eco	Thermo Pro 90	Thermo Top Pro 120/150	Order number
 <p>T-piece with restrictor Da = 20</p>	■	■	■	■	1319817A
 <p>T-piece Da = 18, L = 75, steel corrosion-resistant, with restrictor, restrictor diameter 4 mm</p>	■	■	■	■	1319800A
 <p>Connection pipe Da = 18, L = 75, steel corrosion-resistant</p>	■	■	■	■	1319266A
 <p>Connecting piece Da = 19</p>				■	1320792A
 <p>Solenoid valve Da = 18, L = 84, W = 55, H = 101, 12 V, metal/plastic, plastic casing, 3/2-way, open without power, bag with electrical mounting parts</p>	■	■	■	■	9014606A
 <p>Connecting pipe Da = 15 Da = 18 Da = 20 Steel corrosion-resistant, with bleeder valve</p>	■	■	■	■	1319221A 1319219A 1320989A
 <p>T-piece with bleed valve D1a = 18, D2a = 15</p>	■	■	■	■	1320600A

Water system

	Thermo Top Evo	Thermo Pro 50 Eco	Thermo Pro 90	Thermo Top Pro 120/150	Order number
 <p>Check valve Da = 18, L = 90, steel/brass Da = 20, L = 120, plastic, black Without leak hole</p>	■	■	■	■	1319429A 1319554A
 <p>Rubber ring (anti-chafing device) Di = 25.5, Da = 45, EPDM-50, red, not permitted for exhaust systems Di = 22, Da = 46, not for exhaust system, chafing guard Di = 20.5, Da = 40, elastomer, black, not permitted for exhaust systems L = 20</p>	■	■	■	■	1312780A 1320191A 1312785A
 <p>Woven protection hose Di = 26 ... 30, L = 1,500, polyester, chafing guard for polyester water hoses</p>	■	■	■	■	1322409A
 <p>Expansion tank 8 l, preset pressure 0,5 bar, total volume of system: max. 157 l</p>	■	■	■	■	1320545A
 <p>Header tank L = 252, H = 343, vertical L = 343, H = 252, horizontal W = 120, 5 l, net content 3 liter, made of polypropylene for high temperature resistance, tank kit includes 3 stainless steel mounting brackets</p>	■	■	■	■	9024038A 9024039A
 <p>Header tank D = 120, 10 l H = 300</p>	■	■	■	■	79289500

Mounting parts

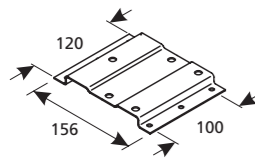
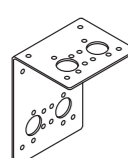
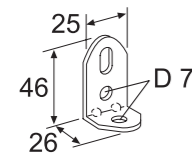
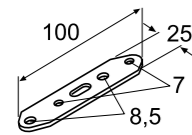
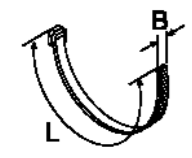
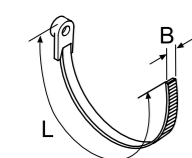
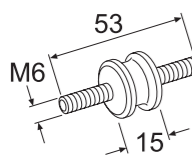
	Air Top 2000 STC	Air Top Evo 40/55	Thermo Top Evo	Thermo Pro 50 Eco	Thermo Pro 90	Thermo Top Pro 120/150	Order number
 <p>Heater bracket Stainless steel</p>					■		1320921A
 <p>Heater bracket Stainless steel, suitable for various installation options</p>	■	■					1319936A
 <p>Mounting bracket Stainless steel steel zinc coated, 10 pieces L = 46, W = 25, D = 26</p>	■	■	■	■	■	■	1320264A 1320232A
 <p>Mounting strip Stainless steel Steel zinc coated, 10 pieces L = 100, W = 25</p>	■	■	■	■	■	■	1319818A 9007918A
 <p>Hose strip L = 178, B = 5.3, bag of 30 pieces</p>	■	■	■	■	■	■	1322447A
 <p>Hose strip 1 piece 10 pieces L = 400, B = 7.6</p>	■	■	■	■	■	■	1320222A 9007917A
 <p>Anti-vibration mount L = 53, M6 thread, not suitable for fastening heaters, 5 pieces</p>					■		1320270A

Mounting parts

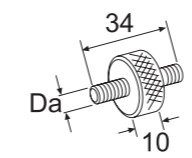
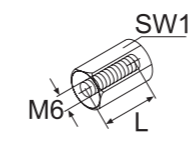
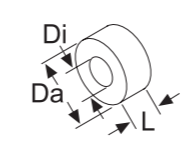
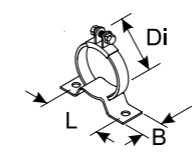
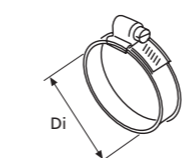
	Air Top 2000 STC	Air Top Evo 40/55	Thermo Top Evo	Thermo Pro 50 Eco	Thermo Pro 90	Thermo Top Pro 120/150	Order number
 <p>Anti-vibration mount Da = thread M6 Da = thread M8 L = 34, not suitable for fastening heaters, 5 pieces</p>	■	■	■		■		9023020A 1319553A
 <p>Spacer nut L = 15 L = 20 L = 30 L = 40 SW = 17, full-length M6 thread, steel corrosion-resistant</p>	■	■	■	■	■	■	1320256A 1320241A 1320083A 1319517A
 <p>Spacer bushing L = 5 L = 8 L = 10 L = 15 L = 20 L = 30 L = 40 Di = 8, Da = 20, aluminium</p>	■	■	■	■	■	■	1320498A 1320499A 1320496A 1320090A 1320088A 1320089A 1319533A
 <p>Mounting / fastening bracket Di = 86, L = 111, B = 25</p>	■	■	■	■	■	■	1319317A
 <p>Hose clip Di = 32 ... 39, stainless steel Di = 40 ... 47, steel corrosion-resistant Di = 48 ... 55, steel corrosion-resistant Di = 60 ... 80, steel corrosion-resistant Di = 70 ... 90, steel corrosion-resistant Di = 72 ... 79, steel corrosion-resistant Di = 80 ... 87, steel corrosion-resistant Di = 90 ... 100, steel corrosion-resistant Di = 98 ... 120, steel corrosion-resistant W = 14.3, SW = 8, bolt head with hexagon and slot</p>	■	■	■	■	■	■	1321732A 1320158A 1320159A 9026066A 1320223A 1320160A 1320162A 1320085A 1320161A

Mounting parts

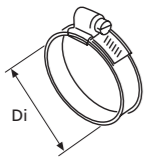
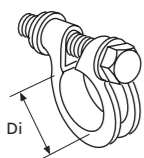
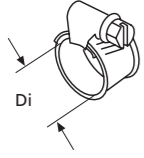
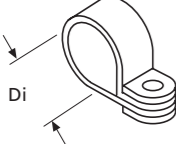
		Air Top 2000 STC	Air Top Evo 40/55	Thermo Top Evo	Thermo Pro 50 Eco	Thermo Pro 90	Thermo Top Pro 120/150	Order number
	Hose clip							
	Di = 16 ... 24	■	■	■	■	■	■	1320502A
	Di = 40 ... 60	■	■	■	■	■	■	1320746A
	Di = 70 ... 90	■	■	■	■	■	■	1320086A
	Di = 80 ... 95	■	■	■	■	■	■	9023950A
	Steel							
	Pipe clamp					■		1320194A
	Di = 39 ... 42, W = 13.5, M8 thread, steel corrosion-resistant, for flexible exhaust pipe, with screw							
	Hose clamp							
	Di = 16 – 27, stainless steel	■	■	■	■	■	■	9015918A
	Di = 28 – 35, stainless steel	■	■	■	■	■	■	1320271A
	Di = 16 – 24, chromium steel	■	■	■	■	■	■	1320248A
	Di = 40 – 50, chromium steel	■	■	■	■	■	■	1321064A
	Pipe clip							
	Di = 25, W = 15, stainless steel	■	■	■	■	■	■	1320045A
	Di = 33, W = 15, stainless steel, 6.5 mm fastening hole	■	■	■	■	■	■	1320064A
	Di = 38, W = 20, stainless steel	■	■	■	■	■	■	1320129A
	Di = 42, W = 12, stainless steel, 5.2 mm fastening hole	■	■	■	■	■	■	1319693A
	Di = 42, W = 15, stainless steel, 6.5 mm fastening hole, 5 pieces	■	■	■	■	■	■	1320276A
	Di = 52, W = 15, steel zinc coated, 6.5 mm fastening hole, 5 pieces	■	■	■	■	■	■	1320265A

Mounting parts

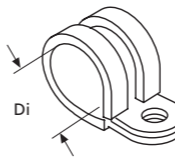
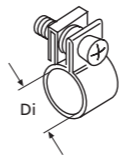
		Air Top 2000 STC	Air Top Evo 40/55	Thermo Top Evo	Thermo Pro 50 Eco	Thermo Pro 90	Thermo Top Pro 120/150	Order number
	Pipe clip							
	Di = 5, stainless steel/rubber, rubber-coated pipe clip, 5.2 mm fastening hole	■	■	■	■	■	■	1320195A
	Di = 29, W = 15 rubber-coat	■	■	■	■	■	■	1320235A
	Di = 34, W = 20 rubber-coat	■	■	■	■	■	■	1320236A
	Di = 38, W = 15 rubber-coat	■	■	■	■	■	■	1320402A
	Hose clip							
	Di = 8, steel corrosion-resistant, 20 pieces	■	■	■	■	■	■	1320244A
	Di = 9, steel corrosion-resistant	■	■	■	■	■	■	1320492A
	Di = 14, steel corrosion-resistant, 20 pieces	■	■	■	■	■	■	1320245A
	Di = 12, steel corrosion-resistant, 20 pieces	■	■	■	■	■	■	1320246A
	Di = 14, stainless steel, 10 pieces W = 9, SW = 7, bolt head with hexagon and cross-head slot	■	■		■	■	■	1320249A

Electrical accessories

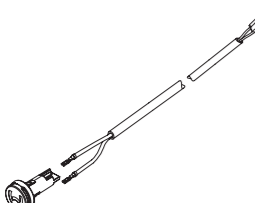
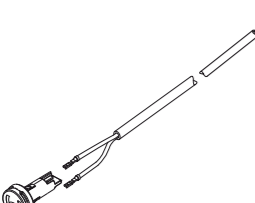
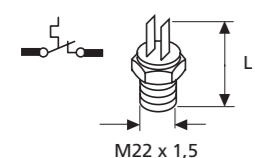
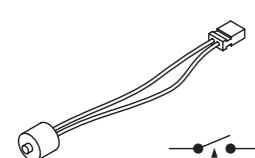
	Air Top 2000 STC	Air Top Evo 40/55	Thermo Top Evo	Thermo Pro 50 Eco	Thermo Pro 90	Thermo Top Pro 120/150	Order number
 <p>Installation frame kit, short</p> <ul style="list-style-type: none"> For standard/combination digital timer and room thermostat, 3 position controller With installation materials 							474630
 <p>Temperature sensor external</p> <p>L = 2.5 m</p> <p>L = 5.0 m</p>		■					9030881A 9030883A
 <p>Temperature sensor external</p> <p>L = 2.5 m</p> <p>L = 5.0 m</p>		■					9037591A 9037593A
 <p>Thermostat (control thermostat)</p> <p>35 – 42°C, opener, L = 38</p> <p>50 – 55°C, opener, L = 38</p> <p>62 – 70°C, opener, L = 39.5</p> <p>71 – 76°C, opener, L = 39.6</p> <p>73 – 78°C, opener, L = 39.6</p> <p>M22 x 1,5</p>					■	■	1319409A 3396532A 1319326A 1319656A 1319657A
 <p>Thermostat</p> <p>40°C, closer</p>			■	■	■	■	1322511A

Service and diagnosis

Heater diagnosis module

Webasto provides a complete set of diagnosis tools to service and repair its heaters. The diagnosis module includes a hardware unit and various connecting adaptors for each heater model. For more details and the latest diagnosis visit our dealer portal at: <http://dealers.webasto.com>

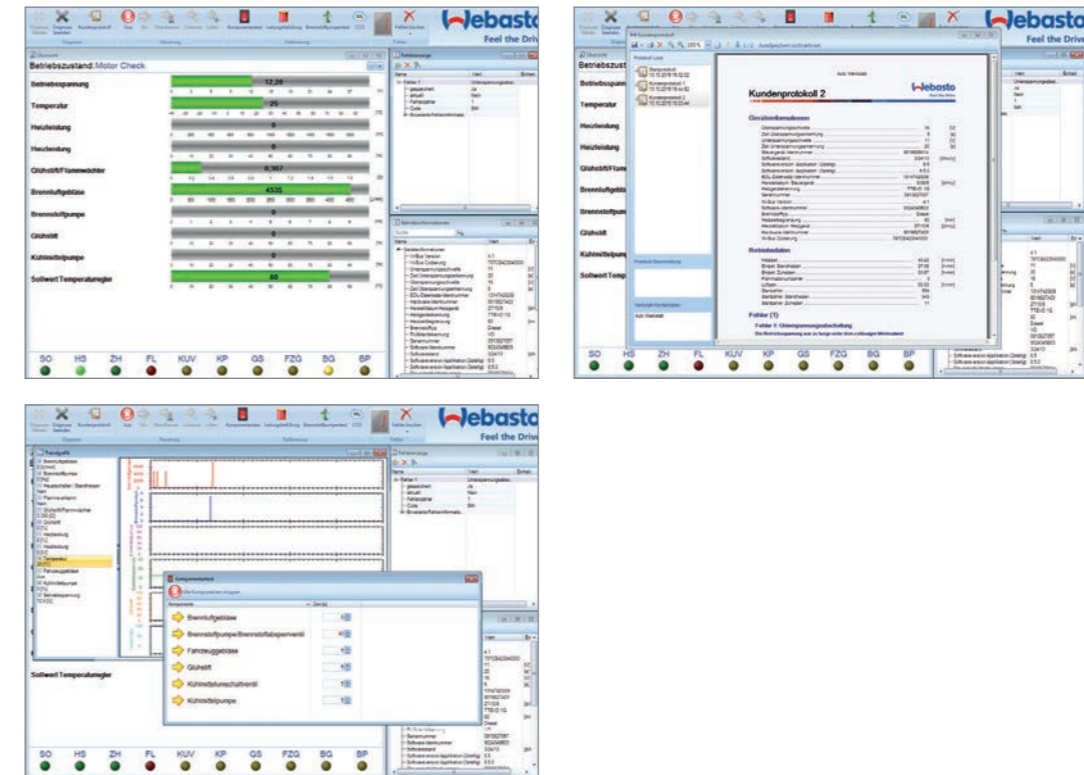

Screenshots from Webasto diagnosis software

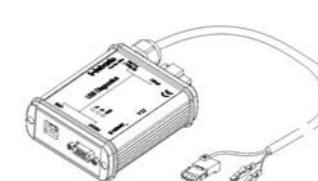
	Air Top 2000 STC	Air Top Evo 40/55	Thermo Top C/E	Thermo Pro 50 Eco	Thermo Top Evo	Thermo Pro 90	Thermo Top Pro 120/150	Thermo S 230/300/350/400	Order number
 <p>PC Diagnosis Kit</p> <p>For Windows operating system, USB and serial port</p>	■	■	■	■	■	■	■	■	1320920A



Cooling products

Which is the right air-conditioning system for your boat? 72

BlueCool self-contained units 76

Product overview 77

Application concept 78

Application guidelines 79

BlueCool S-Series 80

BlueCool chiller systems 82

Product overview 83

Application concept 84

Application guidelines 85

BlueCool V-Series 86

BlueCool C-Series 88

BlueCool P-Series 90

BlueCool Q-Series 98

Blue Cool Air handlers 100

BlueCool A-Series 102

Which is the right air-conditioning system for your boat?



Our large product portfolio from compact air-conditioning systems up to large chiller systems leaves no wish unfulfilled. With our wide power range we provide cooling capacities from 6,000 BTU/h up to 1,500,000 BTU/h.

BlueCool self-contained units



- Perfect solution for vessels with one to three cabins
- Very compact
- Easy to retrofit
- Extremely efficient

or

BlueCool chiller systems



- Large power range to fit any size of boat or superyacht
- Best in marine A/C: Ability to provide adequate cooling wherever it is needed
- Ideal basis for our integrated BlueComfort solutions

+

BlueCool air handlers



- Modular concept enables greatest possible flexibility
- Uses minimal space in cabins since air handlers are smaller than self-contained units
- Three construction forms Compact, Slimline and Low Profile feature an especially compact, slim and flat design of the A-Series

How to choose the right air-conditioner

Example: You own a yacht and would like to aircondition a room of 5 m (length) x 5 m (width) x 2 m (height).

Step 1: Define the category of the cabin

Determine the **category of the cabin**. We give an example for a cabin with an average glass area, for example a deck saloon.

Category 2

Step 2: Define the net volume

Determine the **net volume of the room** (5 m x 5 m x 2 m = 50 m³; subtract 20 % for furniture in the room; 50 m³ – 10 m³ = 40 m³; If you want to air condition the whole boat, please calculate the **sum of your rooms**.

40 m³

Step 3: Define your climate region

Determine the **climate region** where you spend most of your time. For example the Mediterrean Sea is a "normal region" in the climate category.

Normal region

Step 4: Identify your cooling requirements

Result: You need an air conditioning system with a 20,000 BTU/h **cooling capacity**.

20,000 BTU/h

Step 5: Decide between a self-contained and chiller system

Depending on the demands you can decide on a **self-contained or chiller system** with a cooling capacity of 20,000 BTU/h.

BlueCool S20

Step 1	Category 1 portlights only, cabin(s) all below deck [400 BTU/m ³]	Step 3		
		region: normal	cold	hot
Step 2	Volume of the rooms L x W x H (m ³)	4,000	3,000	5,000
	10	8,000	6,000	10,000
	20	12,000	9,000	15,000
	30	16,000	12,000	20,000
	40	20,000	15,000	25,000
	50	24,000	18,000	30,000
	60	28,000	21,000	35,000
	70	32,000	24,000	40,000
	80	36,000	27,000	45,000
	90	40,000	30,000	50,000
	100	44,000	33,000	55,000
	110	48,000	36,000	60,000
	120	52,000	39,000	65,000
	130	56,000	42,000	70,000
	140	60,000	45,000	75,000
	150	64,000	48,000	80,000
	160	68,000	51,000	85,000
	170	72,000	54,000	90,000
	180	76,000	57,000	95,000
	190	80,000	60,000	100,000
200				

For precise BTU calculations, please use our Marine specification and calculation tool, available on the dealer portal at <http://dealers.webasto.com>

The right cooling capacity

Category 1 portlights only, cabin(s) all below deck (400 BTU/m ³)	Step 3		
	region: normal	cold	hot
Volume of the rooms L x W x H (m ³)			
10	4,000	3,000	5,000
20	8,000	6,000	10,000
30	12,000	9,000	15,000
40	16,000	12,000	20,000
50	20,000	15,000	25,000
60	24,000	18,000	30,000
70	28,000	21,000	35,000
80	32,000	24,000	40,000
90	36,000	27,000	45,000
100	40,000	30,000	50,000
110	44,000	33,000	55,000
120	48,000	36,000	60,000
130	52,000	39,000	65,000
140	56,000	42,000	70,000
150	60,000	45,000	75,000
160	64,000	48,000	80,000
170	68,000	51,000	85,000
180	72,000	54,000	90,000
190	76,000	57,000	95,000
200	80,000	60,000	100,000

Category 2 average glass area, cabins partly below deck (500 BTU/m ³)	Step 3		
	region: normal	cold	hot
Volume of the rooms L x W x H (m ³)			
10	5,000	3,750	6,250
20	10,000	7,500	12,500
30	15,000	11,250	18,750
40	20,000	15,000	25,000
50	25,000	18,750	31,250
60	30,000	22,500	37,500
70	35,000	26,250	43,750
80	40,000	30,000	50,000
90	45,000	33,750	56,250
100	50,000	37,500	62,500
110	55,000	41,250	68,750
120	60,000	45,000	75,000
130	65,000	48,750	81,250
140	70,000	52,500	87,500
150	75,000	56,250	93,750
160	80,000	60,000	100,000
170	85,000	63,750	106,250
180	90,000	67,500	112,500
190	95,000	71,250	118,750
200	100,000	75,000	125,000

Category 3 glass area above average, saloon above deck (600 BTU/m ³)	Step 3		
	region: normal	cold	hot
Volume of the rooms L x W x H (m ³)			
10	6,000	4,500	7,500
20	12,000	9,000	15,000
30	18,000	13,500	22,500
40	24,000	18,000	30,000
50	30,000	22,500	37,500
60	36,000	27,000	45,000
70	42,000	31,500	52,500
80	48,000	36,000	60,000
90	54,000	40,500	67,500
100	60,000	45,000	75,000
110	66,000	49,500	82,500
120	72,000	54,000	90,000
130	78,000	58,500	97,500
140	84,000	63,000	105,000
150	90,000	67,500	112,500
160	96,000	72,000	120,000
170	102,000	76,500	127,500
180	108,000	81,000	135,000
190	114,000	85,500	142,500
200	120,000	90,000	150,000

Category 4 very large glass areas, saloon and wheel house above deck (750 BTU/m ³)	Step 3		
	region: normal	cold	hot
Volume of the rooms L x W x H (m ³)			
10	7,500	5,625	9,375
20	15,000	11,250	18,750
30	22,500	16,875	28,125
40	30,000	22,500	37,500
50	37,500	28,125	46,875
60	45,000	33,750	56,250
70	52,500	39,375	65,625
80	60,000	45,000	75,000
90	67,500	50,625	84,375
100	75,000	56,250	93,750
110	82,500	61,875	103,125
120	90,000	67,500	112,500
130	97,500	73,125	121,875
140	105,000	78,750	131,250
150	112,500	84,375	140,625
160	120,000	90,000	150,000
170	127,500	95,625	159,375
180	135,000	101,250	168,750
190	142,500	106,875	178,125
200	150,000	112,500	187,500

For extreme climatic conditions such as the Persian Gulf with sea-water temperatures of 32 °C and air temperatures of 40 °C, you have to add 25 to 30 % onto the calculated figure. On BlueCool P-Series units it is also recommended that the condenser is increased in size.

BlueCool self-contained units

BlueCool S-Series

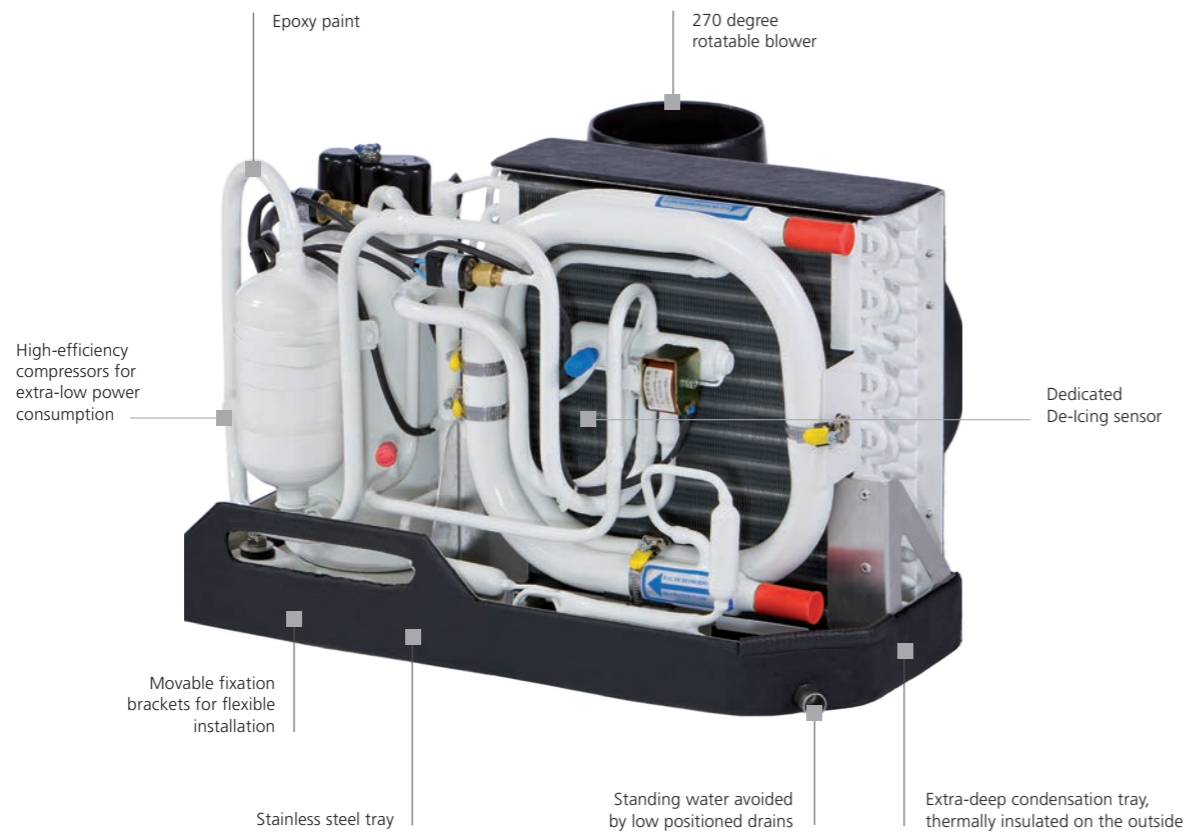

BlueCool self-contained units

Product overview



- BlueCool S-Series S6 – S27 230 V

SEE PAGE 80



- BlueCool S-Series S6-S16 115 V

SEE PAGE 81

The BlueCool S-Series:

- Fully 50/60 Hz compatible (230 V)
- Suitable for worldwide usage
- Very high efficiency, using R410a refrigerant
- Continuous operation even under tropical conditions
- USB diagnosis for easy servicing and parameter setting
- Quiet operation
- Robust design
- Soft start devices available as an option
- Vibration absorber kits available as an option

S-Series comes with the new MyTouch display as a standard



BlueCool MyTouch

Self-contained air-conditioners:

- Stand alone unit
- Heating via reverse cycle integrated
- Extremely compact
- All components on one tray
- Lowest power consumption
- Including electronics, blower and controls
- Evaporator temperature control in real time mode

BlueCool self-contained units

Application concept

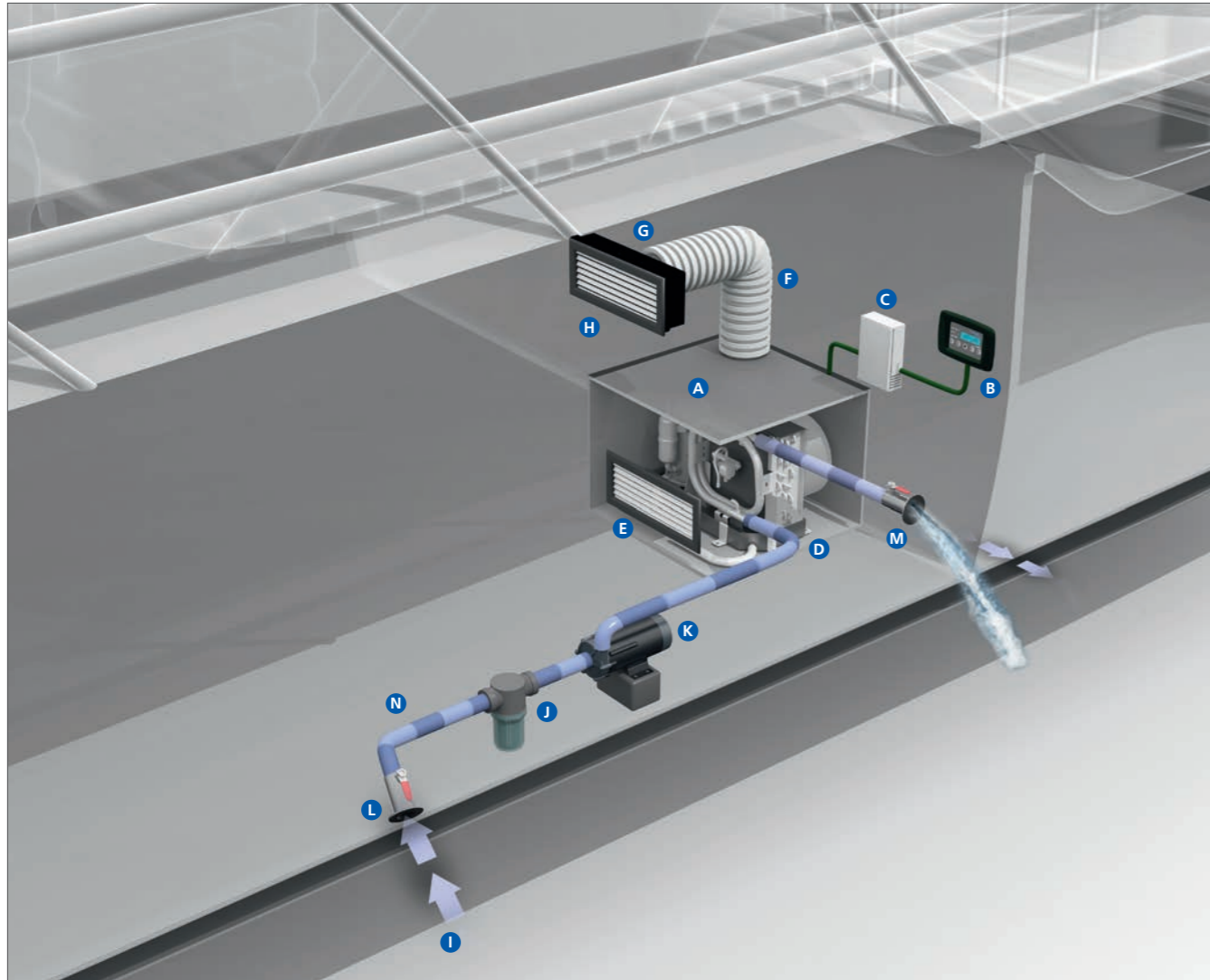

Installation of a BlueCool self-contained unit is quite simple:
Each cabin has its own self-contained unit (A) providing cool air to this cabin.
It is controlled by an air control unit (B) which is also located in this cabin.
The generated heat is transferred into the sea via the sea water circuit (I) to (N).

Webasto BlueCool self-contained units

Webasto BlueCool self-contained air-conditioning units have one hermetically encapsulated compressor. The refrigerant circuit includes not only the compressor but also a condenser, a throttle element (capillary tube) as well as an evaporator. Self-contained units are extremely compact. All components (compressor, condenser, evaporator and blower) required for cooling a cabin, a salon, a lounge or another room are mounted on a stainless steel tray. Webasto self-contained units are available in different power ratings. This means you are sure to find the ideal system for the specific needs of almost all room sizes requiring cooling in a yacht.

BlueCool self-contained units

Application guidelines

For a complete self-contained unit, please select the following:

Core unit

Please select the core unit according to the required cooling capacity.

- A Air-conditioning [SEE PAGE 80](#)
- B Display and control unit [SEE PAGE 116](#)

Position A and B as well as the following components are included in the scope of delivery:

- Electric cable and control box
- Installation manual
- Remote cabin temperature sensor 3 m
- Display cable 5.0 m
- Operating manual

Accessories

Please order separately the accessories for the application consisting of:

- C Soft Starts [SEE PAGE 112](#)
- D Vibration absorber [SEE PAGE 112](#)

Air system

Please order separately the air ducting system for the application consisting of:

- E Return air grille [SEE PAGE 123](#)
- F Air ducting [SEE PAGE 125](#)
- G Transition box [SEE PAGE 124](#)
- H Supply air grille [SEE PAGE 123](#)

Sea water circuit

Please order separately the components for the sea water circuit consisting of:

- I Sea water inlet [SEE PAGE 132](#)
- J Sea water strainer [SEE PAGE 132](#)
- K Sea water pump [SEE PAGE 118](#)
- L Closing valve [SEE PAGE 130](#)
- M Overboard discharge [SEE PAGE 132](#)
- N Water hose [SEE PAGE 131](#)

BlueCool S-Series

Self contained units

Technical data	BlueCool S-Series 230 V						
Type	S6	S8	S10	S13	S16	S20	S27
Order numbers	WBCL120000B	WBCL120001E	WBCL120002E	WBCL120003E	WBCL120004F	WBCL120005E	WBCL120006F
Cooling capacity* (BTU/h)	6,000	8,000	10,000	13,000	16,000	20,000	27,000
Cooling capacity* (kW)	1.8	2.4	2.9	3.8	4.7	5.9	7.9
Heating via reverse cycle integrated	yes	yes	yes	yes	yes	yes	yes
Voltage (V)	230 (-15%/+10%)	230 (-15%/+10%)	230 (-15%/+10%)	230 (-15%/+10%)	230 (-15%/+10%)	230 (-15%/+10%)	230 (-15%/+10%)
Frequency (Hz)	50/60 (+-5%)	50/60 (+-5%)	50/60 (+-5%)	50/60 (+-5%)	50/60 (+-5%)	50/60 (+-5%)	50/60 (+-5%)
Current draw running** (A) 50 Hz	2 – 2,4	2.4 – 3.5	2.6 – 4.0	3.6 – 6.3	4.9 – 7.1	5.9 – 8.9	7.0 – 10.5
Current draw max. peak (A) 50 Hz	14	28	27	37	54	60	77
Current draw RMS40**** (A) 50 Hz	5	17	17	22	35	39	49
Current draw RMS300*** (A) 50 Hz	3	9	9	11	19	20	32
Current draw max. peak with Soft Start (A) 50 Hz	11	12	11	13	22	23	34
Current draw RMS40**** with Soft Start (A) 50 Hz	4	7	7	7	12	14	19
Current draw RMS300*** with Soft Start (A) 50 Hz	3	5	5	5	9	10	17
Locked Rotor Amperage LRA (A)	12	19	19	24	37	43	62
Max. circuit breaker (A)	16	16	16	16	16	16	20 (comp. only)
Air flow (free blowing) (m³/h)	275	275	400	500	625	625	2 x 550
Air flow (free blowing) (cfm)	162	162	235	294	368	368	2 x 324
Seawater connection (mm)	19	19	19	19	19	19	19
Seawater connection (inch)	3/4	3/4	3/4	3/4	3/4	3/4	3/4
Min. seawater flow at 50 Hz (l/min.)	6	8	10	12	14	17	21
Min. seawater flow at 60 Hz (l/min.)	7,5	10	12	14	17	20	25
Recommended seawater pump +	WB250	WB350	WB350	WB350/WB500G	WB500/WB500G	WB500/WB500G	WB1000/WB1000G
Dimensions L x W x H (mm)	405 x 320 x 305	405 x 320 x 305	480 x 335 x 315	510 x 350 x 325	550 x 350 x 370	595 x 340 x 370	575 x 515 x 410
Dimensions L x W x H (inch)	15.9 x 12.6 x 12.0	15.9 x 12.6 x 12.0	18.9 x 13.2 x 12.4	20.1 x 13.8 x 12.8	21.7 x 13.8 x 14.6	23.4 x 13.4 x 14.6	22.6 x 20.3 x 16.1
Blower connection (mm)	100	100	100	125	125	125	2 x 125
Blower connection (inch)	4	4	4	5	5	5	2 x 5
Weight (kg)	20	20	22	27	31	34	46

General note: Values in this table given for 50 Hz only. 60 Hz data available on request.

* BTU/h are based on 7°C evaporating temperature and 38°C condensing temperature

** Amperage values for core unit depend on compressor load. Max values at tropical conditions at 230 V/50 Hz

*** Starting amperage RMS (Root Mean Square) for core unit for first 300 ms

**** Starting amperage RMS (Root Mean Square) for core unit for first 40 ms

+ Recommendation only. Pump size shall be adapted to application constraints in order to always ensure minimal sea water flow.



Soft start device available as an option

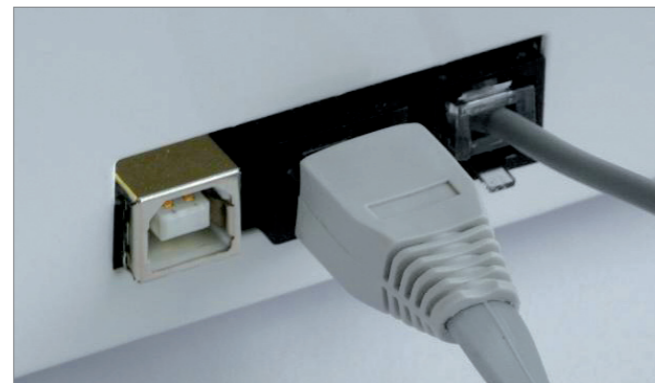

BlueCool Expert, Display and Temperature Sensor access from outside

BlueCool S-Series

Self contained units



Technical data	BlueCool S-Series 115 V				
Type	S6	S8	S10	S13	S16
Order No.	2510139B	2510140B	2510141B	2510142B	2510143B
Cooling capacity* (BTU/h)	6,000	8,000	10,000	13,000	16,000
Cooling capacity* (kW)	1.8	2.4	2.9	3.8	4.7
Heating via reverse cycle integrated	Yes	Yes	Yes	Yes	Yes
Voltage (V)	115 (-15%/+10%)	115 (-15%/+10%)	115 (-15%/+10%)	115 (-15%/+10%)	115 (-15%/+10%)
Frequency (Hz)	60 (+-5%)	60 (+-5%)	60 (+-5%)	60 (+-5%)	60 (+-5%)
Current draw running** (A) 60 Hz	3.6 – 5.5	4.5 – 6.1	5.6 – 7.9	7.6 – 11	8.0 – 15.7
Current draw max. peak (A) 60 Hz	39	54	55	70	89
Current draw RMS40**** (A) 60 Hz	25	35	36	47	59
Current draw RMS300*** (A) 60 Hz	19	20	21	30	35
Locked Rotor Amperage LRA (A)	27	34	37	57	70
Max. circuit breaker (A)	16	16	16	16	25 (compressor only)
Air flow (free blowing) (m³/h)	275	275	350	430	650
Air flow (free blowing) (cfm/h)	162	162	206	253	382
Seawater connection (mm)	19	19	19	19	19
Seawater connection (inch)	3/4	3/4	3/4	3/4	3/4
Minimal Seawater flow (l/min.) 60 Hz	6	8	10	12	14
Recommended seawater pump 60 Hz +	WB250	WB350	WB350	WB350 WB500G	WB500 WB500G
Dimensions L x D x H (mm)	405 x 320 x 300	405 x 320 x 305	480 x 335 x 315	510 x 345 x 325	550 x 340 x 370
Dimensions L x D x H (inch)	15.9 x 12.6 x 11.8	15.9 x 12.6 x 12.0	18.9 x 13.2 x 12.4	20.1 x 13.6 x 12.8	21.7 x 13.4 x 14.6
Blower connection (mm)	100	100	100	125	125
Blower connection (inch)	4	4	4	5	5
Weight (kg)	18	18	20	25	29

* BTU/h are based on 7°C evaporating temperature and 38°C condensing temperature

** Amperage values for core unit depend on compressor load. Max values at tropical conditions at 115 V/60 Hz

*** Starting amperage RMS (Root Mean Square) for core unit for first 300 ms

**** Starting amperage RMS (Root Mean Square) for core unit for first 40 ms

+ Recommendation only. Pump size shall be adapted to application constraints in order to always ensure minimal sea water flow.

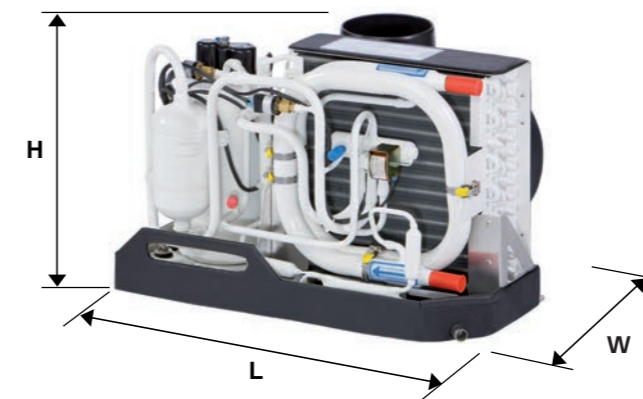

S6 – S20

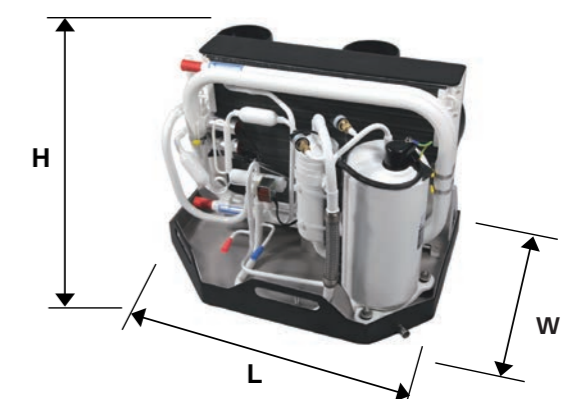

S27

BlueCool chiller systems

BlueCool V-Series

The V-Series is offering variable speed compressor technology to the marine market. This innovative technology with inverter driven compressors allows to modulate the cooling output in a wide range but also eliminates the starting peak which permits to downsize the generator. Additionally it has an advanced control system with new comfort features, it automatically adapts to 50/60 Hz and to hot sea water conditions.

BlueCool C-Series

The C-Series stands for standardized chiller units for small to medium boats. The range goes from 16,000 BTU/h to 108,000 BTU/h. Those chillers are the ideal solution for those who demand a high quality product with a short delivery time. The units come in 230 V 50/60 Hz voltage. Customization options are soft starts as well as vibration dampers.

BlueCool P-Series

The P-Series is Webasto's Professional Chiller Series and is designed for mid-size up to super yachts and commercial boats. They cover a large range of cooling performances from 30,000 up to 572,000 BTU/h. All are equipped with 50 to 60 Hz compatible scroll-compressors and up to four compressors are mounted on a single tray. The P-Series is highly customizable with many options such as soft starts, anti-vibration mounts, CAN Bus control, enlarged condensers for operation under tropical conditions, single phase or three phase compressors. Ask Webasto to have your chiller system individually configured to your needs.

BlueCool Q-Series

The Q-Series is Webasto's Chiller Series with large cooling capacities above 500 kBTU/h. These units are individually built to customer requirements. They feature serviceable compressors and condensers and further options depending on customer requirements.

Chiller systems are now compatible with the new MyTouch display



BlueCool MyTouch

BlueCool chiller systems

Product overview



- BlueCool V-Series V50 M, V64 T, V77 T

SEE PAGE 86



- BlueCool C-Series C16 M to C108 Q

SEE PAGE 88

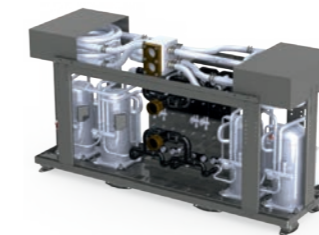

- BlueCool P-Series P30 M to P572 Q

SEE PAGE 90



- BlueCool Q-Series

SEE PAGE 98

BlueCool chiller systems

Application concept

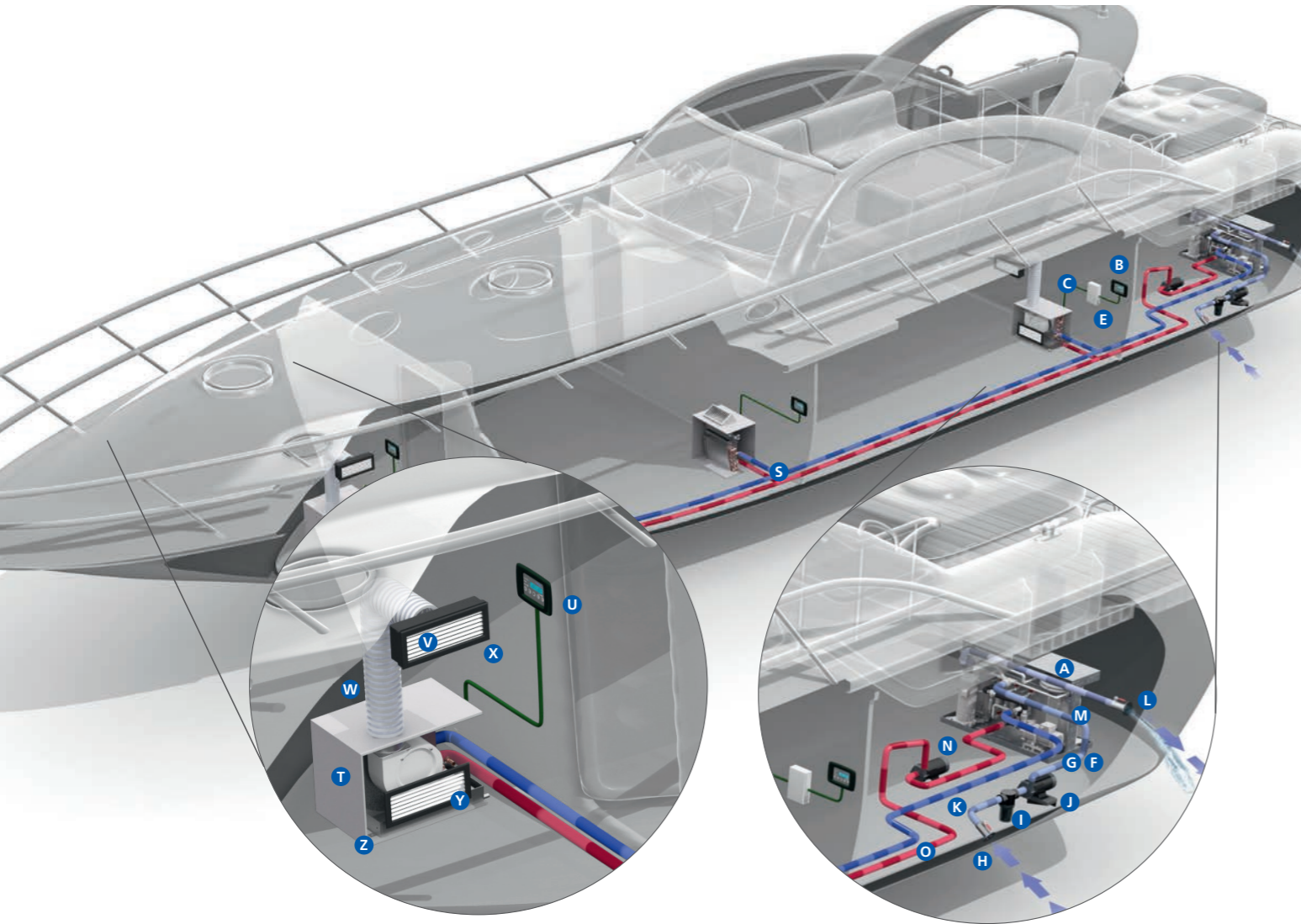

For larger boats with several cabins a chiller system is the best choice. The chiller A/C unit **A** is typically placed in the engine room providing chilled water/glycol to all cabins via the chilled water circuit **N** to **S**. In each cabin one or several air handlers **T** are fitted depending on cooling capacity and space requirements. The Digital Control Panel **B** controls the A/C system itself. For each cabin one Control Panel **U** is needed to individually control the air handler in this cabin. As a result you get full temperature control in each cabin providing maximum comfort on board.

Chiller air-conditioning systems

Whenever three or more independent volumes in a yacht need to be air-conditioned, it becomes worth considering a central chiller system. To distribute cooling capacity over several independently operating air handlers from one single central cooling unit, the most flexible and simple solution is to install a chilled water circulation system between the central unit and the air handlers. This mixed water/glycol circuit is maintained at approx. +4°C. All Webasto chiller units are equipped with high efficiency multi-plate heat exchangers.

BlueCool chiller systems

Application guidelines

For a complete chiller system, please select the following:

Core unit

Please select the core unit according to the required cooling capacity, the available voltage and whether cool only or heating via reverse cycle is needed.

A Air-conditioning unit [SEE PAGE 86–99](#)

Position **A** as well as the following components are included in the scope of delivery:

- Electric cable and control box
- Installation manual
- Operating manual

Control elements for core unit

Please select the control elements for the core unit separately:

- B** MyTouch display [SEE PAGE 114](#)
- C** Display cable [SEE PAGE 116](#)
- D** Remote air temperature sensor [SEE PAGE 116](#)

Accessories for V- and C-Series:

Please order separately the accessories for the V- and C-Series core unit:

- E** Soft Starts [SEE PAGE 112](#)
- F** Vibration absorber kits [SEE PAGE 112](#)
- G** Silent block kits [SEE PAGE 112](#)

Sea water circuit

Please order separately the components for the sea water circuit consisting of:

- H** Sea water inlet [SEE PAGE 132](#)
- I** Sea water strainer [SEE PAGE 132](#)
- J** Sea water pump [SEE PAGE 118](#)
- K** Closing valve [SEE PAGE 130](#)
- L** Overboard discharge [SEE PAGE 132](#)
- M** Water hose [SEE PAGE 131](#)

Chilled water circuit

Please add the required components for the chilled water circuit consisting of:

- N** Circulation pump [SEE PAGE 118](#)
- O** Piping or hosing system with insulation [SEE PAGE 126](#)
- P** 3-way valve (optional) [SEE PAGE 141](#)
- Q** Turn ball valve [SEE PAGE 130](#)
- R** Expansion tank [SEE PAGE 130](#)
- S** T-pieces [SEE PAGE 127](#)

Cabin accessories necessary for each single cabin

Please add for every single cabin the following components and accessories:

- T** Air handler [SEE PAGE 102](#)
- V** Supply air grille [SEE PAGE 123](#)
- W** Air ducting [SEE PAGE 125](#)
- X** Transition box [SEE PAGE 124](#)
- Z** Water hoses for condensation drain [SEE PAGE 131](#)
- U** Cabin control (Control Panel, display cable, temperature sensor and control box) [SEE PAGE 116](#)
- Y** Return air grille [SEE PAGE 123](#)

BlueCool V-Series

Variable speed chiller



V64 T and V77 T



V50 M
without electronic box

BlueCool V-Series

Variable speed chiller



Technical data	BlueCool V-Series		
	V50 M	V64 T	V77 T
Type			
Order No.	WBCL1203001C	WBCL1203003B	WBCL1203002B
Cooling capacity* (BTU/h)	8,500 – 50,000	8,500 – 64,000	8,500 – 77,000
Cooling capacity* (kW)	2.5 – 14.6	2.5 – 18.7	2.5 – 22.6
Heating via reverse cycle integrated	yes	yes	yes
Voltage (V)	230 (-15%/+10%)	230 (-15%/+10%)	230 (-15%/+10%)
Frequency ++ (Hz)	50/60 (+-5%)	50/60 (+-5%)	50/60 (+-5%)
Current draw running** (A)	2.5 – 15* (max. 17)	2.5 – 23.8 (max. 25)	2.5 – 24 (max. 26.5)
Current draw Start (A)	2.5	2.5	2.5
Current draw Eco 1 Mode (A)	2.5 – 8* (max. 12)	2.5 – 15* (max. 17)	2.5 – 15* (max. 17)
Current draw Eco 2 Mode (A)	2.5 – 5* (max. 8)	2.5 – 8* (max. 12)	2.5 – 8* (max. 12)
Current draw Eco 3 Mode (A)	–	2.5 – 5* (max. 8)	2.5 – 5* (max. 8)
Chilled water connection (mm), (Inch)	25 1"	32 1 1/4" F BST	32 1 1/4" F BST
Min. chilled water flow (l/min.)	35	45	52
Seawater connection (mm), (Inch)	25 1" M BST	32 1 1/4" F BST	32 1 1/4" F BST
Min. seawater flow (l/min.)	38	50	57
Dimensions unit L x D x H (mm), (Inch)	567 x 340 x 510 22.3 x 13.4 x 20.1	760 x 560 x 510 29.9 x 22.0 x 20.1	760 x 560 x 510 29.9 x 22.0 x 20.1
Dimensions unit incl. silent block L x D x H (mm), (Inch)	590 x 378 x 548 23.2 x 14.9 x 21.6	760 x 560 x 550 29.9 x 22.0 x 21.7	760 x 560 x 550 29.9 x 22.0 x 21.7
Dimension electronic box L x D x H (mm), (Inch)	560 x 190 x 465 22.0 x 7.5 x 18.3	560 x 190 x 465 22.0 x 7.5 x 18.3	560 x 190 x 465 22.0 x 7.5 x 18.3
Dimension chiller L x D x H (mm), (Inch)	607 x 530 x 510 23.9 x 20.8 x 20.1	760 x 750 x 510 29.9 x 29.5 x 20.1	760 x 750 x 510 29.9 x 29.5 x 20.1
Dimensions unit incl. silent block + box L x D x H (mm), (Inch)	620 x 570 x 548 24.4 x 22.4 x 21.6	760 x 750 x 550 29.9 x 29.5 x 21.7	760 x 750 x 550 29.9 x 29.5 x 21.7
Ambient temperature limit (°C)	60	60	60
Sound level unit (dB/A) (measured)	49.2	48.5	48.5
Refrigerant charge R410A (g)	892	892 + 770	892 + 770
Weight core unit (kg)	47	90	90
Weight electronic box (kg)	15	15	15
Min. sea water temp. heating (°C)	6	6	6
Max. sea water temp. cooling (°C)	35	35	35

* Based on 7°C evaporating temperature and 38°C condensing temperature

** Amperage values for core unit depend on compressor load. Max values at tropical conditions at 230 V/50 Hz

++ BlueCool V-Series systems are tested and approved by Webasto for 50/60 Hz operation

Now compatible with the new MyTouch display



BlueCool MyTouch

The BlueCool V-Series:

- New V64 T and V77 T with innovative hybrid control logic
- Large power modulation range: 8,500 up to 77,000 BTU
- Unique hybrid concept reduces output by 89% during part load operation.
- Variable speed BLDC compressors controlled by inverter technology
- Zero electrical starting peak
- Super quiet operation with little noise variations and sound cover housing
- High system availability via dynamic control of HP/LP boundary conditions
- Preventive maintenance monitoring system
- Condensate free operation
- Easy installation and maintenance
- Low service and operation costs
- Light and compact
- Integrates Webasto s BlueCool Expert diagnosis and set up tool
- Up to 3 ECO modes with adjustable amperage draw
- 230 V 50 Hz or 240 V 60 Hz compatible for worldwide application
- MyTouch as standard user interface with clear text display



BlueCool C-Series

Ultra compact chiller

Technical data	BlueCool C-Series							
Type	C16 M	C20 M	C27 M	C32 T	C40 T	C55 T	C81 R	C108 Q
Order numbers	WBCL1205001E	WBCL1205002D	WBCL1205003D	WBCL1207001E	WBCL1207002D	WBCL1207003D	WBCL1207004D	WBCL1207005D
Cooling capacity* (BTU/h)	16,000	20,000	27,000	32,000	40,000	55,000	81,000	108,000
Cooling capacity* (kW)	4.7	5.9	7.9	9.4	11.7	16.1	23.7	31.7
Heating via reverse cycle integrated	yes	yes	yes	yes	yes	yes	yes	yes
Voltage (V)	230 (-15%/+10%)	230 (-15%/+10%)	230 (-15%/+10%)	230 (-15%/+10%)	230 (-15%/+10%)	230 (-15%/+10%)	230 (-15%/+10%)	230 (-15%/+10%)
Frequency ++ (Hz)	50/60 (+-5%)	50/60 (+-5%)	50/60 (+-5%)	50/60 (+-5%)	50/60 (+-5%)	50/60 (+-5%)	50/60 (+-5%)	50/60 (+-5%)
Current draw running** (A)	4.4 – 6.0	6.9 – 8.0	8.6 – 9.2	8.8 – 12.0	13.8 – 16.0	17.2 – 18.4	25.8 – 27.6	34.4 – 36.8
Current draw Start max. peak (A) 50 Hz	54	60	77	60	68	87	97	107
Current draw RMS40**** (A) 50 Hz	35	39	49	41	47	59	69	79
Current draw RMS300**** (A) 50 Hz	19	20	32	25	28	42	52	62
Current draw Start max. peak with Soft Start (A) 50 Hz	22	22	34	28	30	44	54	64
Current draw RMS40**** with Soft Start (A) 50 Hz	12	14	18	18	22	28	38	48
Current draw RMS300 with Soft Start (A) 50 Hz	9	10	17	15	18	27	37	47
Locked Rotor Amperage LRA (A) (comp. only)	37	43	54	37	43	54	54	54
Max. circuit breaker (A)	16	16	20	2 x 16	2 x 16	2 x 20	3 x 20	4 x 20
Chilled water connection (mm)	25	25	25	25	25	25	32	–
Chilled water connection (inch)	1	1	1	1	1	1	1 1/4	1 1/4 F BST
Minimal chilled water flow (l/min.)	13	16	19	26	32	38	57	76
Recommended chilled water pump	WB500	WB500	WB1000	WB1000	WB1500	WB1500	WB2000	WB3500
Seawater connection (mm)	19	19	19	19	25	25	32	–
Seawater connection (inch)	3/4	3/4	3/4	3/4	1	1	1 1/4	1 1/4 F BST
Minimal seawater flow at 50 Hz (l/min.)	14	17	21	28	34	42	63	84
Minimal seawater flow at 60 Hz (l/min.)	17	20	25	34	41	50	75	100
Recommended seawater pump	WB500/ WB500G	WB500/ WB500G	WB1000	WB1000	WB1500/ WB1000G	WB1500/ WB2000	WB2000/ WB2500G	WB3000G
Dimensions L x W x H (mm)	390 x 290 x 355	440 x 330 x 360	440 x 330 x 395	590 x 410 x 500	590 x 410 x 500	590 x 410 x 550	870 x 430 x 575	860 x 640 x 600
Dimensions L x W x H (inch)	15.4 x 11.4 x 14.0	17.3 x 13.0 x 14.0	17.3 x 13.0 x 15.6	23.2 x 16.1 x 19.7	23.2 x 16.1 x 19.7	23.2 x 16.1 x 21.7	33.5 x 16.9 x 22.6	33.9 x 22.4 x 23.6
Weight (kg)	34	37	45	65	70	86	119	173
Min. sea water temp. Heating (°C)	6	6	6	6	6	6	6	6
Max. sea water temp. Cooling (°C)	35	35	35	35	35	35	35	35

General note: Values in this table given for 50 Hz only. 60 Hz data available on request.
 * BTU/h are based on 7 °C evaporating temperature and 38 °C condensing temperature
 ** Amperage values for core unit depend on compressor load. Max values at tropical conditions at 230 V/50 Hz
 *** Starting amperage RMS (Root Mean Square) for core unit for first 300 ms
 **** Starting amperage RMS (Root Mean Square) for core unit for first 40 ms
 + Recommendation only. Pump size shall be adapted to application constraints in order to always ensure minimal sea water flow.
 ++ BlueCool C-Series systems are tested and approved by Webasto for 50/60 Hz operation

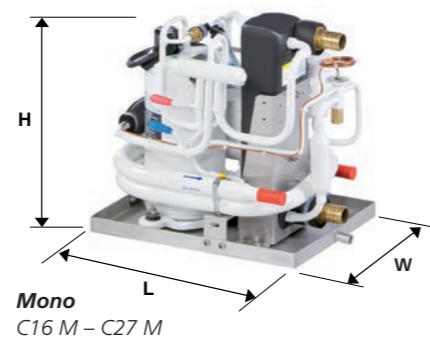

BlueCool C-Series

Ultra compact chiller



Now compatible with the new MyTouch display



BlueCool MyTouch

The BlueCool C-Series:

- Improved performance and up to 15 % higher efficiency
- Continuous cooling capacity even in tropical conditions
- Even more compact design
- New improved electronics for easy installation and diagnosis via USB cable
- Optional CAN-Bus for optimized adaptation to boat systems
- Compressor noise is reduced by up to 25 %
- Easy sea water and chilled water connections at one side
- Strong stainless steel tray and condensate drain
- High quality Epoxy paint protection
- Vibration absorber and Silent block available as an option
- Soft start devices available as an option

BlueCool P-Series

Professional Chiller Series

BlueCool P-Series

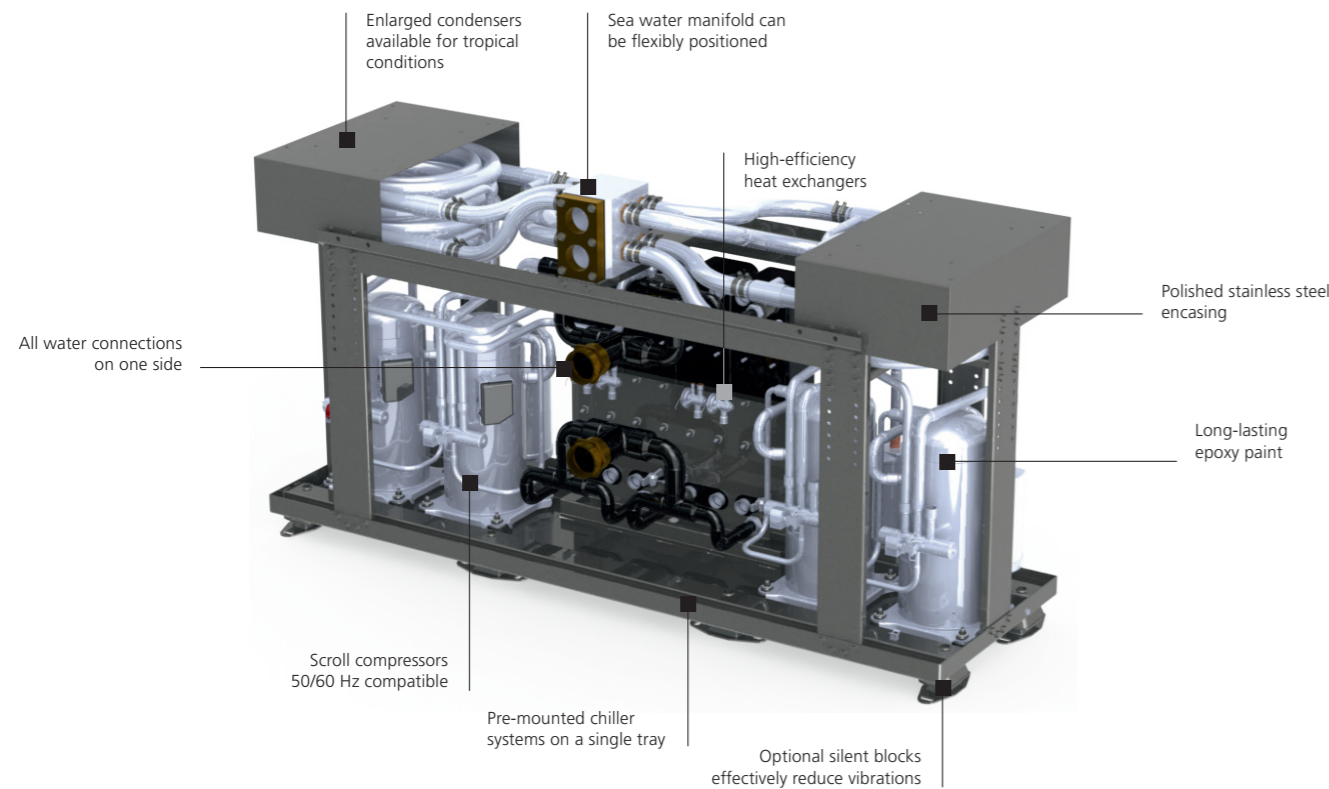

Now compatible with the new MyTouch display



BlueCool MyTouch

The professional BlueCool P-Series:

- Professional chiller system for medium to large boats and super yachts
- Highly customizable chiller series with large range of 30,000 – 572,000 BTU/h to adapt to cooling demand
- Successor of our BlueCool Premium scroll compressor range for high reliability
- Multiple compressor units with independent cooling circuits for high availability
- Range extension with 8 new models
- Improved electronics – new electronic box with easier access to components – new PCB with increased circuit protection, now also fulfilling highest EMC standards EN 60945 – the electronic box has been slightly enlarged so that softstarts can be easily integrated into this box
- BlueCool Expert tool for service, configuration, application tuning, diagnosis and system setup comes as a standard free of charge
- Optional CAN-Bus for integration into boats central monitoring systems
- Unique Thermostatic Advance Function for power output continuously adapted to cooling demand
- Redesigned trays for easier mounting of silent blocks to reduce vibrations
- Electrical systems can be upgraded to customer needs with PRO box or fulfilling MCA requirements

BlueCool P-Series

Configuration options

Configure your chiller system in 6 main steps:

Product options for BlueCool P-Series

The BlueCool P-Series is highly customizable to the demands of shipyards and national legislation. In addition to a wide range of cooling capacities, many options can be selected to customize the chiller to your needs. For further options, please contact the sales support team at Webasto.

Option 1: Voltage

All P-Series chillers are available as 400 V/3-phase version. On most models 208 V/3-phase or 230 V/single phase is available as well.

Option 2: Cool only version

For regions where heating is not required some units are available as cool only version.

Option 3: Tropical version

For high sea water temperatures > 32 °C, a tropical chiller version with enlarged condensers shall be selected to avoid high pressure cut-outs. Option is highly recommended whenever the boat may travel in regions where sea water temperatures may be above 32 °C.

Option 4: Soft start

In order to reduce the amperage draw at compressor start a soft start may be chosen as an option.

- Soft start devices are reducing the amperage peak at compressor start up to 53 %
- Soft start models are available for 400 V 3-phase as well as 230 V single phase
- The peak reduction allows to better size the power generator and it frees capacities for other electrical consumers
- Light flickering is reduced
- Circuit breakers and cables sizes do not have to be oversized
- The soft starts fit into the standard electrical box if no further electrical accessories are chosen
- If the soft starts are selected during the chiller configuration process they come already installed and tested as part of the electronic box





BlueCool P-Series

Configuration options

Option 5: Electrical upgrades

In the standard configuration, the chiller comes with a standard electrical box which allows to operate the chiller. Webasto offers a wide variety of electrical options which enhance the operation and service comfort or ease the electrical installation. Some options may be required to comply with national standards or requirements coming from the boat's classification society. Depending on the amounts of options chosen the larger PRO box or even a box compliant to MCA standards will be used. Each box will be individually configured to your needs.

			
	Standard Box	Pro Box	MCA Box
Housing			
Material	Galvanized steel, epoxy painted	Mild steel, powder coated	Mild steel, powder coated
IP class	IP21	IP66/NEMA 4, 12, 13/IK 10	IP66/NEMA 4, 12, 13/IK 10
Color	White	RAL 7035	RAL 7035
Opening/closing	Screws	Locking mechanism	Locks with removable handle
Components included			
Chiller electronic card	<input type="checkbox"/>	<input type="checkbox"/>	<input type="checkbox"/>
Relays for compressors, chilled water and sea water pump	<input type="checkbox"/>	<input type="checkbox"/>	<input type="checkbox"/>
Terminal block connectors	<input type="checkbox"/>	<input type="checkbox"/>	<input type="checkbox"/>
Compressor Soft starts	<input type="checkbox"/>	<input type="checkbox"/>	<input type="checkbox"/>
Motor protective relays and circuit breakers for compressors and pumps	-	<input type="checkbox"/>	<input type="checkbox"/>
Circuit breaker for chiller electronic card	-	<input type="checkbox"/>	<input type="checkbox"/>
Only one power supply needed for entire unit	-	<input type="checkbox"/>	<input type="checkbox"/>
Halogen free cables	-	<input type="checkbox"/>	<input type="checkbox"/>
Cable harness length: 2 m	<input type="checkbox"/>	<input type="checkbox"/>	<input type="checkbox"/>
Increased cable harness length: 5 m/10 m/15 m	<input type="checkbox"/>	<input type="checkbox"/>	<input type="checkbox"/>
Chilled water pump: redundancy selector for two pumps	-	<input type="checkbox"/>	<input type="checkbox"/>
Sea water pump: redundancy selector for two pumps	-	<input type="checkbox"/>	<input type="checkbox"/>
Power ON lamp	-	<input type="checkbox"/>	<input type="checkbox"/>
Pilot lamps for pumps and/or compressors	-	<input type="checkbox"/>	<input type="checkbox"/>
Digital display integrated at the front door	-	<input type="checkbox"/>	<input type="checkbox"/>
Compressor running counter	-	<input type="checkbox"/>	<input type="checkbox"/>
Main switch	-	-	<input type="checkbox"/>
Emergency stop	-	-	<input type="checkbox"/>
Pushbutton to test pilot lamps	-	-	<input type="checkbox"/>
Door locking mechanism in open position	-	<input type="checkbox"/>	<input type="checkbox"/>
Ampere gauge	-	-	<input type="checkbox"/>

Standard Optional - Not available

Option 6: Silent blocks

Silent blocks may be mounted between the chiller unit and the hull of the boat to reduce structural born vibrations being transferred from the chiller unit into the boat.

- The silent blocks very effectively reduce vibrations into the hull of the boat by up to 50 %
- Silent blocks are mounted below the base plate of the A/C unit
- High performance damping elements specially designed for the vibration frequency and the weight of each unit
- Marine grade with corrosion resistant materials
- Integrated rip-off protection
- If the silent blocks are selected during the chiller configuration process they come already mounted onto the A/C unit
- Please ask for the specific height increase of your unit as the silent block type varies with the size of the units

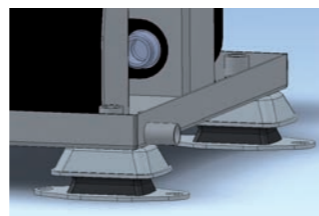

BlueCool P-Series

Project assistance and support

A chiller system always needs to be customized to each boat in order to meet the demands of shipyards, owners, classification societies and national legislation. We support you in this process with our expertise and the tools we have developed for this.

Specification and quotation tool

This tool should be used for all A/C projects to

- Precisely calculate the cooling and heating demand for each cabin depending on boat characteristics, performance requirements and usage conditions
- Determine the fresh air requirements of larger boats
- Select your bill of material from the entire product portfolio
- Summarize technical data of the chosen key components

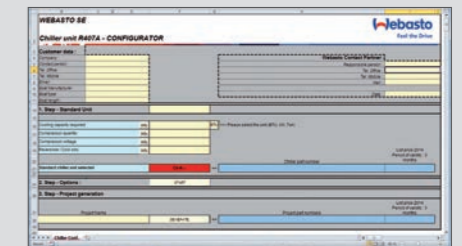

As a result the chiller and air handlers are correctly sized to the individual demand of each boat.

Chiller configurator tool

This tool is used by Webasto to

- Select the available options for a chiller unit, see Options 1, 2, 3, 6 on previous pages
- Select the available electrical options, see Options 4 and 5 on previous pages

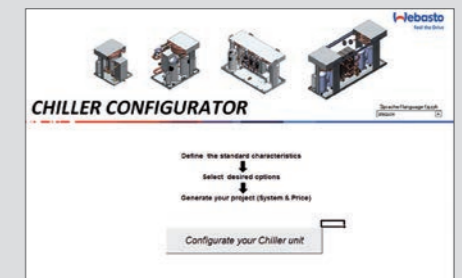

As a result your chiller and electronic box will receive an individual part number which is uniquely used for your project.

Engineering support

Our project engineers support you in various phases of a project delivering to you

- A/C system concepts
- Piping diagrams
- Electrical wiring schematics
- On-site support to understand and determine the optimal A/C configuration

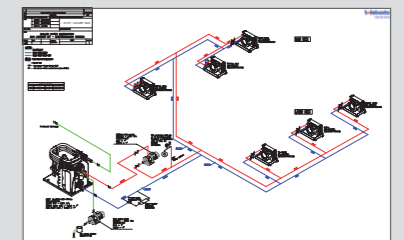

Installation and commissioning support

Our project engineers can support you on demand during the installation and commissioning phase of your project with

- Technical support to answer your questions
- On-site support and audit
- Check of your installation
- Support during system commissioning



BlueCool P-Series

Professional Chiller Series

Type	BlueCool P-Series Triple chiller				
	P126 R	P144 R	P180 R	P216 R	P252 R
Cooling capacity* (BTU/h)	126,000	144,000	180,000	216,000	252,000
Cooling capacity* (kW)	37	42.2	52.8	63.3	73.8
Frequency (Hz)	50/60	50/60	50/60	50/60	50/60
Current draw running** (A) for 230 V 1-phase	28	37	-	-	-
Current draw running** (A) for 400 V 3-phase	12	15	18	20	25
Current draw running** (A) for 208 V 3-phase	21	26	50	38	72
Current draw running FLA **** (A) for 230 V 1-phase	69	71	-	-	-
Current draw running FLA **** (A) for 400 V 3-phase	21	30	33	36.3	45
Current draw running FLA **** (A) for 208 V 3-phase	40	56	75	81	76
Locked Rotor Amperage LRA (A) for Single compressor 230 V 1-phase	100	114	-	-	-
Locked Rotor Amperage LRA (A) for Single compressor 400 V 3-phase	46	50	59	74	101
Locked Rotor Amperage LRA (A) for Single compressor 208 V 3-phase	95	98	139	172	179
Min. chilled water flow (l/min.)	104	115	138	158	180
Min. seawater flow (l/min.)	82	92	106	125	145
Recommended seawater pump+	WB3000G WB3500	WB3000G WB3500	WB5500	WB5500	WB5500
Dimensions (L x W x H) (mm)	640 x 1,250 x 765	640 x 1,250 x 765	640 x 1,250 x 765	640 x 1,250 x 840	640 x 1,250 x 840
Dimensions (L x W x H) (inch)	25.2 x 49.2 x 30.1	25.2 x 49.2 x 30.1	25.2 x 49.2 x 30.1	25.2 x 49.2 x 33.1	25.2 x 49.2 x 33.1
Dimensions (L x W x H) (mm) tropical	640 x 1,250 x 765	640 x 1,250 x 765	640 x 1,250 x 840	640 x 1,250 x 840	640 x 1,250 x 840
Dimensions (L x W x H) (inch) tropical	25.2 x 49.2 x 30.1	25.2 x 49.2 x 30.1	25.2 x 49.2 x 33.1	25.2 x 49.2 x 33.1	25.2 x 49.2 x 33.1
Weight (kg)	180	190	210	250	260
Available options					
230 V/1-phase	<input type="checkbox"/>	<input type="checkbox"/>	-	-	-
208 V/3-phase	<input type="checkbox"/>	<input type="checkbox"/>	<input type="checkbox"/>	<input type="checkbox"/>	<input type="checkbox"/>
Reverse Cycle Heating	<input type="checkbox"/>	<input type="checkbox"/>	<input type="checkbox"/>	<input type="checkbox"/>	<input type="checkbox"/>
Cool Only version	<input type="checkbox"/>	<input type="checkbox"/>	<input type="checkbox"/>	<input type="checkbox"/>	<input type="checkbox"/>
Tropicalized version	<input type="checkbox"/>	<input type="checkbox"/>	<input type="checkbox"/>	<input type="checkbox"/>	<input type="checkbox"/>
Soft Start 400 V/230 V/208 V	<input type="checkbox"/> / <input type="checkbox"/> / -	<input type="checkbox"/> / - / -	<input type="checkbox"/> / - / -	<input type="checkbox"/> / - / -	<input type="checkbox"/> / - / -
Upgrade box/MCA Box	<input type="checkbox"/>	<input type="checkbox"/>	<input type="checkbox"/>	<input type="checkbox"/>	<input type="checkbox"/>
Silent Block	<input type="checkbox"/>	<input type="checkbox"/>	<input type="checkbox"/>	<input type="checkbox"/>	<input type="checkbox"/>

General note:
 Values in this table given for 50 Hz only. 60 Hz data available on request.
 * BTU/h are based on 7°C evaporating temperature and 38°C condensing temperature
 ** Amperage values for core unit at nominal conditions at 50 Hz
 **** FLA (Full Load Amperage) is the current draw at maximum conditions
 + Recommendation only. Pump size shall be adapted to application constraints in order to always ensure minimal sea water flow.
 ++ BlueCool P-Series systems are tested and approved by Webasto for 50/60 Hz operation.
 Standard
 Option
 - Not available

BlueCool P-Series

Professional Chiller Series

Webasto engineers can quote custom manufactured chiller systems upon request. Please contact us for a tailored solution to fit your individual needs.

Type	BlueCool P-Series Quattro chiller										
	P120 Q	P144 Q	P168 Q	P192 Q	P240 Q	P288 Q	P336 Q	P384 Q	P448 Q	P504 Q	P572 Q
Cooling capacity* (BTU/h)	120,000	144,000	168,000	192,000	240,000	288,000	336,000	384,000	448,000	504,000	572,000
Cooling capacity* (kW)	35	42.2	49.2	56.2	70	85	99	112	132	148	168
Frequency (Hz)	50/60	50/60	50/60	50/60	50/60	50/60	50/60	50/60	50/60	50/60	50/60
Current draw running** (A) for 230 V 1-phase	27	32	38	49	-	-	-	-	-	-	-
Current draw running** (A) for 400 V 3-phase	12	14	16	21	23	26	34	40	43	49	53
Current draw running** (A) for 208 V 3-phase	20	24	28	34	66	51	95	-	-	-	-
Current draw running FLA**** (A) for 230 V 1-phase	59	69	92	94	-	-	-	-	-	-	-
Current draw running FLA**** (A) for 400 V 3-phase	20	22	28	40	44	48	60	64	67	78	89
Current draw running FLA**** (A) for 208 V 3-phase	41	44	54	74	100	108	100	-	-	-	-
Locked Rotor Amperage LRA (A) for Single compressor 230 V 1-phase	61	76	100	114	-	-	-	-	-	-	-
Locked Rotor Amperage LRA (A) for Single compressor 400 V 3-phase	32	40	46	50	59	74	101	95	111	118	118
Locked Rotor Amperage LRA (A) for Single compressor 208 V 3-phase	70	83	95	98	139	172	179	-	-	-	-
Min. chilled water flow (l/min.)	100	115	132	161	175	220	245	275	310	360	420
Min. seawater flow (l/min.)	80	92	100	115	140	162	180	200	240	270	325
Recommended seawater pump+	WB3000G WB3500	WB5500	WB5500	WB5500	WB5500	WB5500 WB7400	WB5500 WB7400	WB7400	WB7400 WB9800	WB7400 WB9800	WB7400 WB9800
Dimensions (L x W x H) (mm)	1,390 x 560 x 640	1,390 x 560 x 665	1,715 x 560 x 850	1,715 x 560 x 850	1,715 x 560 x 850	1,715 x 560 x 850	1,715 x 560 x 850	2,030 x 635 x 843	2,030 x 635 x 918	2,030 x 635 x 1,067	2,030 x 635 x 1,068
Dimensions (L x W x H) (inch)	54.7 x 22 x 25.2	54.7 x 22 x 26.2	67.5 x 22 x 33.5	67.5 x 22 x 33.5	67.5 x 22 x 33.5	67.5 x 22 x 33.5	67.5 x 22 x 33.5	79.9 x 25 x 33.2	79.9 x 25 x 36.1	79.9 x 25 x 42	79.9 x 25 x 42
Dimensions (L x W x H) (mm) tropical	1,390 x 560 x 665	1,390 x 560 x 665	1,715 x 560 x 850	1,715 x 560 x 850	1,715 x 560 x 850	1,715 x 560 x 850	1,715 x 560 x 850	2,030 x 635 x 843	2,030 x 635 x 1,068	2,030 x 635 x 1,068	2,030 x 635 x 1,068
Dimensions (L x W x H) (inch) tropical	54.7 x 22 x 26.2	54.7 x 22 x 26.2	67.5 x 22 x 33.5	67.5 x 22 x 33.5	67.5 x 22 x 33.5	67.5 x 22 x 33.5	67.5 x 22 x 33.5	79.9 x 25 x 33.2	79.9 x 25 x 42	79.9 x 25 x 42	79.9 x 25 x 42
Weight (kg)	190	210	285	307	339	350	350	450	670	670	725
Available options											
230 V/1-phase	<input type="checkbox"/>	<input type="checkbox"/>	<input type="checkbox"/>	<input type="checkbox"/>	-	-	-	-	-	-	-
208 V/3-phase	<input type="checkbox"/>	<input type="checkbox"/>	<input type="checkbox"/>	<input type="checkbox"/>	<input type="checkbox"/>	<input type="checkbox"/>	<input type="checkbox"/>	-	-	-	-
Reverse Cycle Heating	<input type="checkbox"/>	<input type="checkbox"/>	<input type="checkbox"/>	<input type="checkbox"/>	<input type="checkbox"/>	<input type="checkbox"/>	<input type="checkbox"/>	<input type="checkbox"/>	<input type="checkbox"/>	<input type="checkbox"/>	<input type="checkbox"/>
Cool Only version	<input type="checkbox"/>	<input type="checkbox"/>	<input type="checkbox"/>	-	<input type="checkbox"/>	<input type="checkbox"/>	<input type="checkbox"/>	<input type="checkbox"/>	<input type="checkbox"/>	<input type="checkbox"/>	<input type="checkbox"/>
Tropicalized version	<input type="checkbox"/>	<input type="checkbox"/>	<input type="checkbox"/>	<input type="checkbox"/>	<input type="checkbox"/>	<input type="checkbox"/>	<input type="checkbox"/>	<input type="checkbox"/>	<input type="checkbox"/>	<input type="checkbox"/>	<input type="checkbox"/>
Soft Start 400 V/230 V/208 V	<input type="checkbox"/> / <input type="checkbox"/> / -	<input type="checkbox"/> / - / -	<input type="checkbox"/> / - / -	<input type="checkbox"/> / - / -	<input type="checkbox"/> / - / -	<input type="checkbox"/> / - / -	<input type="checkbox"/> / - / -	<input type="checkbox"/> / - / -	<input type="checkbox"/> / - / -	<input type="checkbox"/> / - / -	<input type="checkbox"/> / - / -
Upgrade box/MCA Box	<input type="checkbox"/>	<input type="checkbox"/>	<input type="checkbox"/>	<input type="checkbox"/>	<input type="checkbox"/>	<input type="checkbox"/>	<input type="checkbox"/>	<input type="checkbox"/>	<input type="checkbox"/>	<input type="checkbox"/>	<input type="checkbox"/>
Silent Block	<input type="checkbox"/>	<input type="checkbox"/>	<input type="checkbox"/>	<input type="checkbox"/>	<input type="checkbox"/>	<input type="checkbox"/>	<input type="checkbox"/>	<input type="checkbox"/>	<input type="checkbox"/>	<input type="checkbox"/>	<input type="checkbox"/>

General note: Values in this table given for 50 Hz only. 60 Hz data available on request.
 * BTU/h are based on 7°C evaporating temperature and 38°C condensing temperature
 ** Amperage values for core unit at nominal conditions at 50 Hz
 **** FLA (Full Load Amperage) is the current draw at maximum conditions
 + Recommendation only. Pump size shall be adapted to application constraints in order to always ensure minimal sea water flow.
 ++ BlueCool P-Series systems are tested and approved by Webasto for 50/60 Hz operation.
 Standard Option - Not available

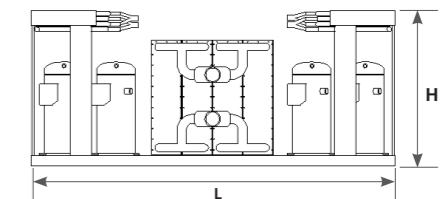
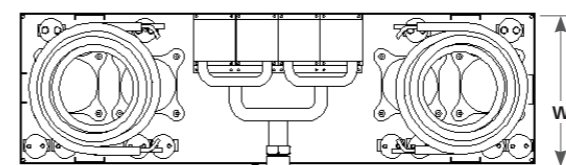

BlueCool Q-Series

High capacity professional chiller units

A large chiller system always needs to be customized to each boat in order to meet the demands of shipyards, owners, classification societies and national legislation. To cover cooling performances from 500,000 up to 1,500,000 BTU/h Webasto offers the BlueCool Q-Series.

The BlueCool Q-Series is designed on customer request for super yachts and commercial boats. Its modular concept, the sea water resistant design, it's robust steel frame, easy serviceability and various more options like tropical versions or MCA electrical boxes make the Q-Series the product fitting to your needs. Ask Webasto to have your chiller system individually developed.

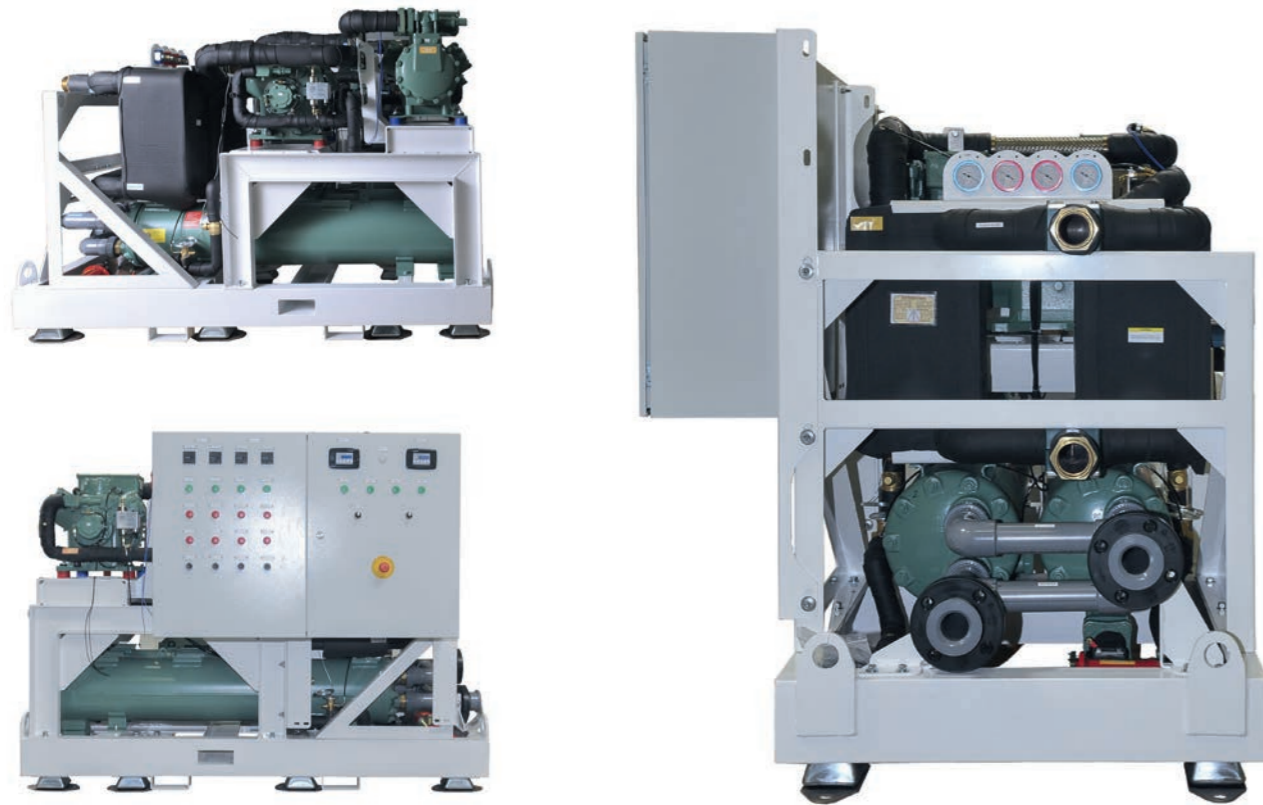

Examples of a 2-stage Q-Series high capacity chiller unit

- The dimensions of the unit can be adapted to customer requirement. This ensures that the available space on board is optimally used
- Solid metal frame allows handling by forklifts and cranes
- Silent blocks below frame effectively reduce vibrations if required
- Entire cooling system can be configured with redundancy to ensure full cooling system availability
- Up to 6 compressors can be controlled by one central control system
- Different compressor voltages available
- Webasto also offers commissioning service to ensure proper system installation and functioning

BlueCool Q-Series

High capacity professional chiller units

Technical data	BlueCool Q-Series
Cooling capacity (BTU/h) range	500 – 1,500 kBTU/h
Cooling capacity (kW) range	147 – 440
Voltage (V)	360 – 690
Frequency (Hz)	50/60
Refrigerant types	R134a, R407c, F1234yf
Min. sea water temp. Heating (°C)	6
Max. sea water temp. Cooling (°C)*	35

* Higher temperature on request



737T-RP-460 V-R407c

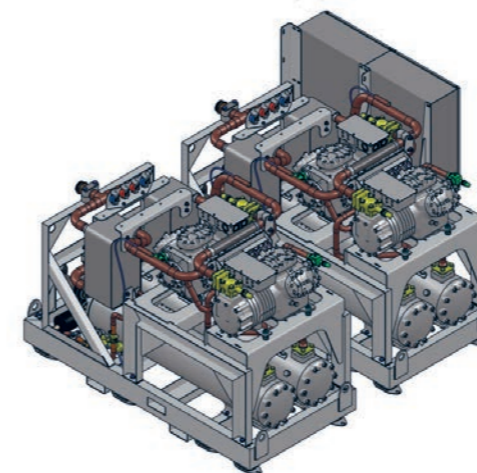

Project based development

- High capacity chillers as project based development
- Modular concept allows to combine multiple units into one integrated system
- Easy maintainable semi-hermetic compressor
- Heat exchanger tubes with highly efficient tube geometry and anti-fouling profile on the coolant side
- Detachable end cover of tube condenser to permit mechanical cleaning of the pipes
- Several customer specific options available such as gauges, redundancy controls, CAN bus interfaces etc.
- Optional 100% pump-down capacity for making circuit repairs without recovering the refrigerant

BlueCool A-Series

Instant Drain system

New BlueCool A-Series

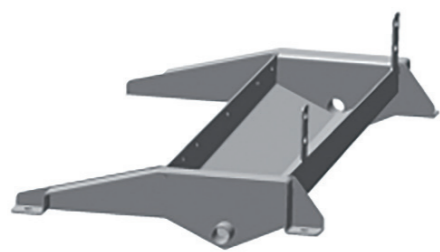
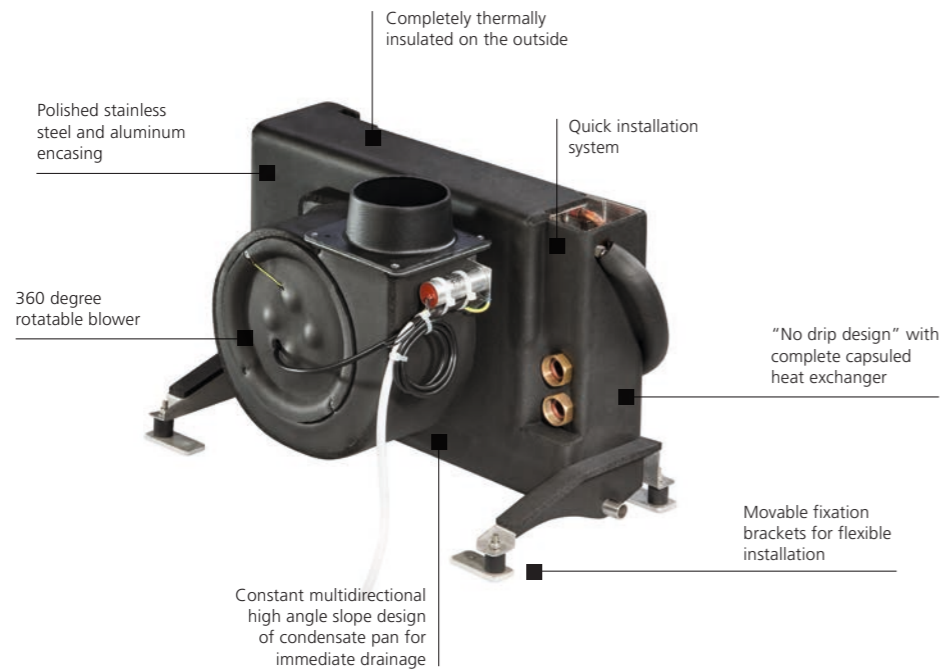

Smart design: constant multi-directional slope.

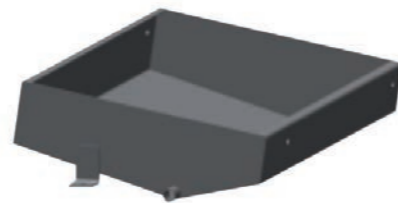

Extra high condensate pan walls for Low profile models.

Exclusive Instant Drain condensate management system

- Constant multidirectional high angle slope design of condensate pan for immediate drainage
- Anti splash condensate management
- "No drip design" with complete capsuled heat exchanger through additional side plates and improved insulation

Air handlers: BlueCool A-Series

Modular system to fit any demand

Webasto offers a range of air handlers to fit any demand on capacity or space limitations. The modular concept makes the A-Series adaptable to individual requirements and the exclusive Webasto Instant Drain condensate management system ensures immediate drainage. New accessories like the Ultimate Cabin Control, MyTouch display, electric heat modules or flow control valves can fine-tune your applications.



BlueCool A-Series

One or more air handler(s) in each cabin are fitted to generate the required cooling capacities individually in each room. Webasto provides a completely new designed air handler portfolio in 3 different layouts with a performance range from 4,000 – 36,000 BTU/h to suit all sizes and space requirements of your boat.



EHM – Electric heat module

The electric heat module EHM ensures cabin heating independent from chiller operation. It is easily installed in-line into the air duct of the A-Series air handlers and provides 600 – 1800 W capacity to enable heating in selective cabins while chiller is in cooling mode.



Flow control valve

The flow control valve allows the chilled water to bypass the heat exchanger of the A-Series when needed. The comfort on boards is increased while directing the chilled water only to those cabins with cooling/heating demand. Continuous blower operation is possible to reduce noise variations in cabins.



Cabin Controls

Choose between New Ultimate Cabin Control with Ultra silent blower operation and master-slave integration or Standard Cabin Control. Both available as complete kits with all necessary components.



BlueCool A-Series

Modular air handler system



Model	Compact						
	A4 Compact	A6 Compact	A9 Compact	A12 Compact	A18 Compact	A24 Compact	A36 Compact
Order numbers	WBCL1209009A	WBCL1209010A	WBCL1209011A	WBCL1209012A	WBCL1209013A	WBCL1209014A	WBCL1209015A
Capacity (BTU/h) **	4,000	6,000	9,000	12,000	18,000	24,000	36,000
Capacity (kW) **	1.2	1.9	2.8	3.6	5.6	7.2	10.7
Voltage (V)	230 (-15%/+10%)	230 (-15%/+10%)	230 (-15%/+10%)	230 (-15%/+10%)	230 (-15%/+10%)	230 (-15%/+10%)	230 (-15%/+10%)
Frequency (Hz)	50/60 (+-5%)	50/60 (+-5%)	50/60 (+-5%)	50/60 (+-5%)	50/60 (+-5%)	50/60 (+-5%)	50/60 (+-5%)
Air flow (m³/h) *	230	380	420	560	750	1120	1550
Air flow (cfm) *	135	224	247	330	441	659	912
Ø Blower connection (mm)	100 (round)	125 (round)	125 (round)	150 (oval)	150 (oval)	2 x 150 (oval)	2 x 150 (oval)
Ø Blower connection (inch)	4 (round)	5 (round)	5 (round)	6 (oval)	6 (oval)	2 x 6 (oval)	2 x 6 (oval)
Weight (kg)	6	7	9	10	12	16	21
Weight (lbs)	13.2	15.4	18.7	22	26.5	35.3	46.3
Current draw running (A)	0.6	0.5	0.6	0.7	1	1.3	2.1
Ø Chilled water connection	3/4"	3/4"	3/4"	3/4"	3/4"	3/4"	3/4"
Dimensions H x W x L (mm)	287 x 249 x 381	287 x 280 x 411	312 x 291 x 456	312 x 279 x 491	362 x 281 x 581	362 x 301 x 636	487 x 302 x 701
Dimensions H x W x L (inch)	11.3 x 9.8 x 15	11.3 x 11 x 16.2	12.3 x 11.5 x 18	12.3 x 11 x 19.3	14.3 x 11.1 x 22.9	14.3 x 11.9 x 25	19.2 x 11.9 x 27.6
Dimensions with valve H x W x L (mm)	287 x 249 x 381	287 x 280 x 411	312 x 291 x 456	312 x 279 x 491	362 x 281 x 581	362 x 301 x 636	487 x 302 x 701
Dimensions with valve H x W x L (inch)	11.3 x 9.8 x 15	11.3 x 11 x 16.2	12.3 x 11.5 x 18	12.3 x 11 x 19.3	14.3 x 11.1 x 22.9	14.3 x 11.9 x 25	19.2 x 11.9 x 27.6
Minimum chilled water flow (l/min.)	4	7	10	9	13	21	31
Number of blowers	1	1	1	1	1	2	2
Max. ambient temperature (°C)	50	50	50	50	50	50	50
Pressure loss chilled water (bar)	0.07	0.12	0.15	0.14	0.16	0.13	0.34
Number of condensate drains	2	2	2	2	2	2	2
Ø Condensate drain (mm)	16	16	16	16	16	16	16

* With 2 m of air duct, one 90° bend, air outlet grille at 230 V, 50 Hz ** Intake air of 32°C/47% rh, water inlet temperature of 5°C and at 230 V, 50 Hz

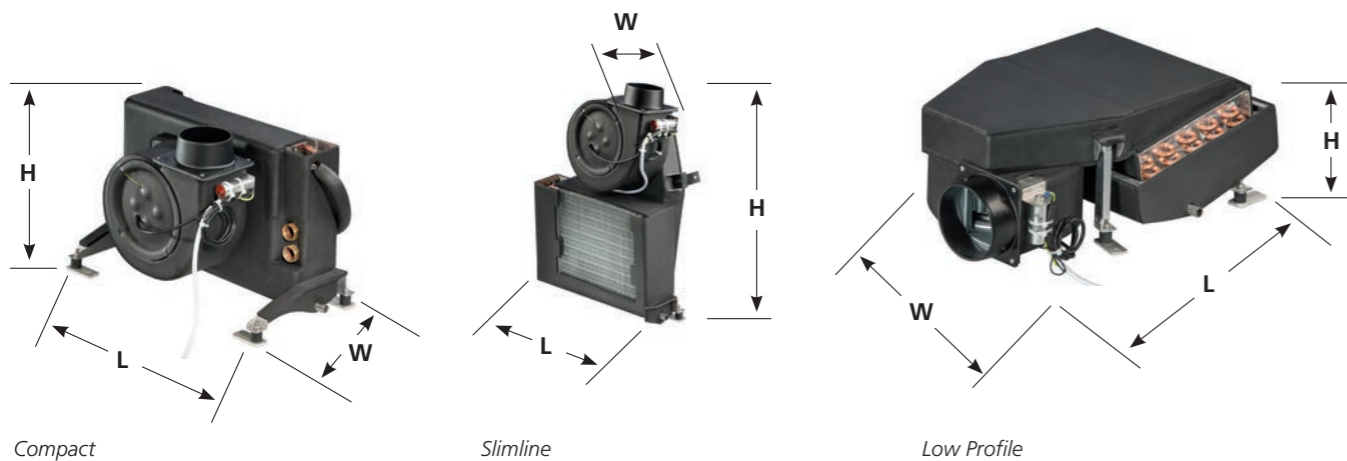

BlueCool A-Series

Modular air handler system

Model	Slimline				Low Profile			
	A6 Slimline	A9 Slimline	A12 Slimline	A18 Slimline	A6 Low Profile	A9 Low Profile	A12 Low Profile	A18 Low Profile
Order numbers	WBCL1209001A	WBCL1209002A	WBCL1209003A	WBCL1209004A	WBCL1209005A	WBCL1209006A	WBCL1209007A	WBCL1209008A
Capacity (BTU/h) **	6,000	9,000	12,000	18,000	6,000	9,000	12,000	18,000
Capacity (kW) **	1.9	2.8	3.6	5.6	1.9	2.8	3.6	5.6
Voltage (V)	230 (-15%/+10%)	230 (-15%/+10%)	230 (-15%/+10%)	230 (-15%/+10%)	230 (-15%/+10%)	230 (-15%/+10%)	230 (-15%/+10%)	230 (-15%/+10%)
Frequency (Hz)	50/60 (+-5%)	50/60 (+-5%)	50/60 (+-5%)	50/60 (+-5%)	50/60 (+-5%)	50/60 (+-5%)	50/60 (+-5%)	50/60 (+-5%)
Air flow (m³/h) *	380	420	560	750	380	420	560	750
Air flow (cfm) *	224	247	330	441	224	247	330	441
Ø Blower connection (mm)	125 (round)	125 (round)	150 (oval)	150 (oval)	125 (round)	125 (round)	150 (oval)	150 (oval)
Ø Blower connection (inch)	5 (round)	5 (round)	6 (oval)	6 (oval)	5 (round)	5 (round)	6 (oval)	6 (oval)
Weight (kg)	7	9	10	12	10	11	13	16
Weight (lbs)	15.4	19.8	22	26.5	21.6	24.3	28.7	35.3
Current draw running (A)	0.5	0.6	0.7	1.1	0.5	0.6	0.7	1.1
Ø Chilled water connection	3/4"	3/4"	3/4"	3/4"	3/4"	3/4"	3/4"	3/4"
Dimensions H x W x L (mm)	588 x 217 x 411	611 x 217 x 456	619 x 217 x 494	666 x 218 x 581	205 x 437 x 582	205 x 482 x 606	205 x 516 x 614	205 x 599 x 661
Dimensions H x W x L (inch)	23.1 x 8.5 x 16.2	24.1 x 8.5 x 18	24.4 x 8.5 x 19.4	26.2 x 8.6 x 22.9	8.1 x 17.2 x 22.9	8.1 x 19 x 23.9	8.1 x 20.3 x 24.2	8.1 x 23.6 x 26
Dimensions with valve H x W x L (mm)	588 x 217 x 479	611 x 217 x 524	619 x 217 x 559	666 x 218 x 649	205 x 487 x 582	205 x 532 x 606	205 x 567 x 614	230 x 657 x 661
Dimensions with valve H x W x L (inch)	23.1 x 8.5 x 18.9	24.1 x 8.5 x 20.6	24.4 x 8.5 x 22	26.2 x 8.6 x 25.6	8.1 x 19.2 x 22.9	8.1 x 20.9 x 23.9	8.1 x 22.3 x 24.2	9.1 x 25.9 x 26
Minimum chilled water flow (l/min.)	7	10	9	13	7	10	9	13
Number of blowers	1	1	1	1	1	1	1	1
Max. ambient temperature (°C)	50	50	50	50	50	50	50	50
Pressure loss chilled water (bar)	0.12	0.15	0.14	0.16	0.12	0.15	0.14	0.16
Number of condensate drains	2	2	2	2	2	2	2	2
Ø Condensate drain (mm)	16	16	16	16	16	16	16	16

The MyTouch display is included in the A-Series Cabin Control Kit



BlueCool MyTouch

- Three possible shapes to cope with any installation demand: Compact, Slimline and Low profile
- New modular system with various options
- Innovative Webasto Instant Drain system for smart management of condensate
- High quality stainless steel condensate tray
- High performance with high cooling capacity and high air flow
- Super Silent with
 - flexible vibration isolation mounts
 - larger ducts to reduce noise from air speed
- Oversized heat exchanger tested under tropical conditions
- Rotatable blower

BlueCool A-Series

EHM – Electric heat module

Type	EHM600W -100 mm -230 V -50/60 Hz	EHM900W -125 mm -230 V -50/60 Hz	EHM1200W -150 mm -230 V -50/60 Hz	EHM1800W -150 mm -230 V -50/60 Hz
Order numbers	WBCL1209100A	WBCL1209101A	WBCL1209102A	WBCL1209103A
Capacity (W)	600	900	1,200	1,800
Dimensions (L x W x H) (mm)	370 x 100 x 170	370 x 125 x 195	370 x 150 x 220	370 x 150 x 220
Dimensions (L x W x H) (inch)	14.6 x 3.9 x 6.7	14.6 x 4.9 x 7.7	14.6 x 5.9 x 8.7	14.6 x 5.9 x 8.7
Ø Hose connection (mm)	100	125	150	150
Ø Hose connection (inch)	4	5	6	6
Voltage (V)	230 (-15%/+10%)	230 (-15%/+10%)	230 (-15%/+10%)	230 (-15%/+10%)
Frequency (Hz)	50/60 (+5%)	50/60 (+5%)	50/60 (+5%)	50/60 (+5%)
Current draw running (A)	3	4	5	8
Max. supply air temperature (°C)	40	40	40	40
Cut off temperature safety switch (°C)	60	60	60	60
Pressure loss air (Pa)	60	60	60	60
Min. air flow (m³/h) to ensure full heat output	60	80	120	180
Weight (kg)	2.2	2.6	2.8	3

Compatibility	A4 Compact	A6 Compact, Slimline, Low Profile	A9 Compact, Slimline, Low Profile	A12 Compact, Slimline, Low Profile	A18 Compact, Slimline, Low Profile	A24 Compact	A36 Compact
EHM600W	■	□	□	□	□	□	□
EHM900W	-	■	■	-	□	-	□
EHM1200W	-	-	-	■	■	■	■
EHM1800W	-	-	-	-	■	-	■

■ Standard application, check on minimum airflow in technical data. □ Only for secondary ducts with smaller diameter, check on minimum airflow in technical data.

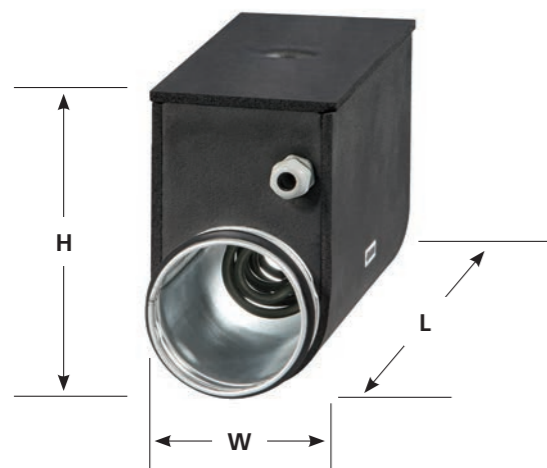

EHM – Electric heat module

- Electric heat modules ensure cabin heating independent of chiller operation
- They are easily installed in-line into air duct of the A-Series air handlers
- EHM is directly connected to A-Series electronics so no separate controls are needed
- EHM further increase the comfort on board by:
 - enabling heating in selective cabins while chiller is in cooling mode
 - enable heating while chiller is switched off
 - increasing the heat output of air handlers if extra high heat demand is needed
- EHM can easily be retrofitted to existing A-Series
- EHM is preinsulated to prevent condensation on the outside. It also comes with 2 stainless steel mounting brackets for wall mounting
- When using EHM a flow control valve also needs to be fitted

BlueCool A-Series

Flow control valve



Valve with motor actuator	Kit Motor Valve Slimline / Low profile A-Series with 90° elbow	Kit Motor Valve Compact A-Series
Order numbers	WBCL151004B	WBCL151003B

Valve with thermal actuator*	Kit Therm Valve Slimline / Low profile A-Series with 90° elbow	Kit Therm Valve Compact A-Series NEW
Order numbers	2510181A	2510182A

* Valves with thermal actuator are suitable for A-Series model from A4 up to A18. Due to their longer activation time they are not suitable to be operated in permanent blower mode.



Flow control valve for Slimline and Low Profile



Flow control valve for Compact

- The flow control valve acts as a 3/2-way valve allowing the chilled water to bypass the heat exchanger of the A-Series when needed
- Easy screw connection to all A-Series units, no soldering needed
- Easy electrical connection to A-Series electronics
- 90° elbows in the Slimline/Low profile kit enable an extra flat installation
- The flow control further increases the comfort on board by:
 - directing the chilled water only to those cabins with cooling/heating demand
 - prevent inadvertent heating when air handler is switched off – no chimney effect
 - prevents condensate build-up and thus mold on heat exchangers of air handlers which are switched off
 - continuous blower operation is possible thus reducing noise variations in cabins
- Valve needs to be fitted if EHM is installed to prevent simultaneous heating and cooling

BlueCool A-Series

Ultimate Cabin Control – Ultra silent blower operation

NEW

Ultimate Cabin Control – the 2 in 1 solution to provide very silent blower operation and to control a network of BlueCool A-Series air handlers.

1. High performance Silencer

Standard Cabin Control: Phase-cutting principle

The standard Cabin Control kit uses the phase-cutting principle with triacs to control the blower motor speed. This chops the incoming sine wave and thus creates electrical bursts which hit the blower motor and cause mechanical noises such as humming and vibration, particularly in low blower speed levels.

Ultimate Cabin Control: PWM for blower speed control

The new Ultimate Cabin Control uses pulse width modulation (PWM) to operate the AC-driven blower motor. With such fast pulses in a frequency of 10 to 16 kHz the amperage reaching the blower motor is very smooth and thus does not cause any humming noise or vibrations in low blower speeds. It also allows to run the blower in very low speed levels to marginalize air flow noise. The Ultimate Cabin Control can be used with all Blue Cool A-Series air handlers.

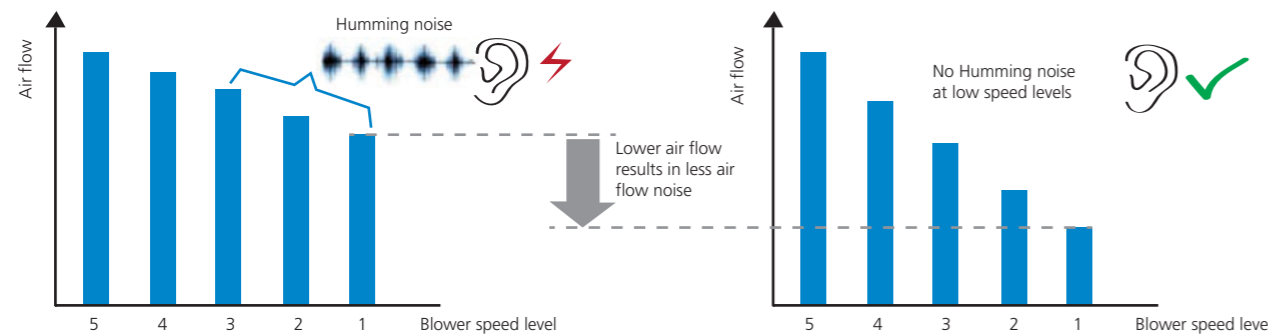

2. Control of a network of Air Handlers via „Master-Slave integration“

One Ultimate Cabin Control box is already capable to control several air handlers with a max. total amperage of 3.15 A. For larger cabins requiring more air handlers, one single BlueCool My Touch user interface can control up to 15 Ultimate Cabin Control devices networked together in a “Master-Slave integration”.



New Ultimate Cabin Control

- Ultra silent blower operation due to PWM control
- Innovative Master-Slave integration allows to connect multiple units together
- Individually adjustable 5-step fan speed
- Compatible to all BlueCool A-Series air handlers
- Meets the highest EMC requirements of IEC/EN 60945
- One MyTouch display can operate all connected cabin controls

BlueCool A-Series

Cabin Control Kits



	Cabin Controls for BlueCool A-Series	Order number
	Ultimate Cabin Control Kit Kit includes: Electrical box with controller card, MyTouch display with Webasto cover plate, display cable 5 m, air temperature sensor 3 m. Max. switching current 3,15 A. Will be the “Master” unit in a Master-Slave configuration	2510197A
	Ultimate Cabin Control Includes: Electrical box with controller card. Max. switching current 3,15 A. Shall be configured as “Slave” unit in a Master-Slave configuration	2510198A
	Cabin Control Kit A-Series Includes: Electrical box with controller card, MyTouch display with Webasto cover plate, display cable 5 m, air temperature sensor 3 m. Max. switching current 2 x 3,15 A.	WBCL151000C

Cabin Control for BlueCool A-Series

- Complete kits available including all necessary components
- Pre-configured for all BlueCool A-Series
- Integrates Webasto s BlueCool Expert Tool diagnosis and set up tool
- MyTouch as standard user interface with clear text display
- Optional CAN-Bus for optimized adaptations to boat systems



Accessories for cooling systems

Fresh air and air extraction units	110
Blower modules and air flow regulators	111
Accessories for S-, V- and C-Series	112
BlueCool Expert Tool	113
Air-conditioning control elements	114
Controls	116
Self-priming pumps	118
Pumps	119
Air system	122
Water system	127

Fresh air and air extraction units

Features and functioning principles

- Regulate fresh-air entry into the vessel by temperature differential outside/inside and combined air extraction control
- Basic regulation by adjustable temperature differential outside/inside with programmable extreme limits and short cycle limits
- 2-stage integrated reheat (AC electrical) provided
- Electronic controller provides two separate blower outlets: one for fresh-air input and one for extraction air out. Different speed settings possible for both outlets. All speed settings including the maximum speed completely re-programmable. A manual control for the speed is possible
- Special flow regulators allow easy and precise balancing of outputs per volume
- Integrated Solenoid 3-way valve control
- Special start-up procedure to eliminate residual moisture in system
- Three temperature read-outs:
 - Outside air temperature
 - Chilled water circuit temperature
 - Treated air input temperature
- Air flow regulators to be specified according to application

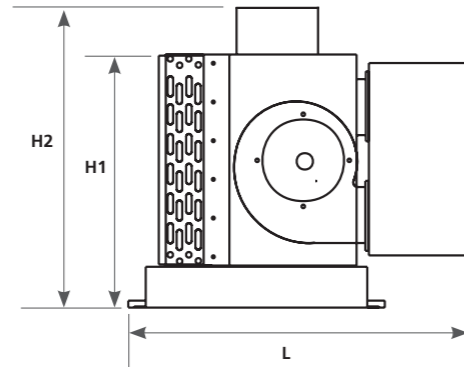
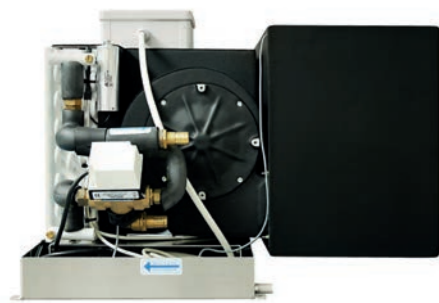

Fresh air unit

Model	Performance	Air flow	Electronic heating capacity	Length L	Height H1	Height H2	Depth D	Weight	Order number
Fresh Air 24	24,000 BTU/h 7 kW	900 m ³ /h 530 cfm	2 x 1,000 W	700 mm 27.6 inch	430 mm 16.9 inch	540 mm 21.3 inch	585 mm 23 inch	35 kg 77 lbs	WBCL005241B
Fresh Air 24 SP	24,000 BTU/h 7 kW	1,800 m ³ /h 1,060 cfm	2 x 1,000 W	700 mm 27.6 inch	430 mm 16.9 inch	540 mm 21.3 inch	585 mm 23 inch	35 kg 77 lbs	WBCL005242B
Fresh Air 48	48,000 BTU/h 14 kW	1,800 m ³ /h 1,060 cfm	4 x 1,000 W	850 mm 33.5 inch	512 mm 20.2 inch	565 mm 22.2 inch	925 mm 36.41 inch	45 kg 100 lbs	WBCL005240B
Fresh Air 2 x 24	48,000 BTU/h 14 kW	1,800 m ³ /h 1,060 cfm	2 x 1,000 W	940 mm 37 inch	490 mm 19.3 inch	570 mm 22.4 inch	620 mm 24.4 inch	48 kg 106 lbs	WBCL000218B

Air extraction unit

Model	Performance	Air flow	Electronic heating capacity	Length L	Height H1	Height H2	Depth D	Weight	Order number
Extract 900	-	900 m ³ /h 530 cfm	-	515 mm 20.3 inch	435 mm 17.1 inch	-	585 mm 23 inch	18 kg 40 lbs	WBCL000216
Extract 1800	-	1,800 m ³ /h 1,060 cfm	-	515 mm 20.3 inch	435 mm 17.1 inch	-	615 mm 24.2 inch	21 kg 46 lbs	WBCL000219

Blower modules and air flow regulators

Inline blower modules

- Provide fresh air to or extract air from the cabins
- Special fan design provides a high air flow at low noise
- Low electrical power consumption
- Removable engine body allows easy maintenance
- Speed controllable motor, two speed, Class B, IP44

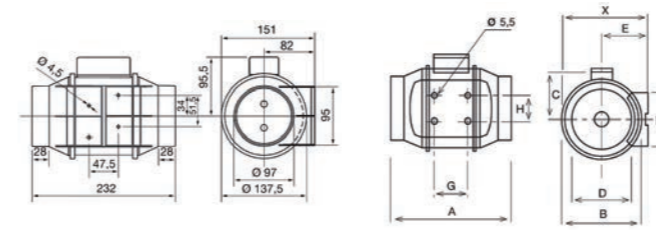

Model 160

Model 250 & 350

Model	X	A	Ø B	C	Ø D	E	F	G	H
250	188	303	176	115	97	100	90	80	60
350	188	258	176	115	123	100	90	80	60

Model	Speed level	Speed (r.p.m.)	Electrical power consumption	Air flow at free discharge	Maximum operating temperature	Sound pressure level* (dB(A))	Power supply	Ø Duct	Weight	Order number
Inline extractor blower 160	II	2,500	20 W	180 m ³ /h, 106 cfm	40	24	~230 V 50 Hz	100 mm 4 inch	1.4 kg 3.1 lbs	WBCL010152A
	I	2,200	12 W	140 m ³ /h, 82 cfm	40	21				
Inline extractor blower 250	II	2,200	24 W	240 m ³ /h, 141 cfm	40	31	~230 V 50 Hz	100 mm 4 inch	2.0 kg 4.4 lbs	WBCL010157A
	I	1,850	18 W	180 m ³ /h, 106 cfm	40	26				
Inline extractor blower 350	II	2,250	30 W	360 m ³ /h, 212 cfm	40	33	~230 V 50 Hz	125 mm 5 inch	2.0 kg 4.4 lbs	WBCL010158A
	I	1,900	22 W	280 m ³ /h, 165 cfm	40	28				
Inline extractor blower 500	II	2,500	50 W	580 m ³ /h, 341 cfm	60	33	~230 V 50 Hz	150 mm 6 inch	2.7 kg 5.9 lbs	WBCL010229A
	I	1,900	44 W	430 m ³ /h, 253 cfm	60	29				

* Sound pressure level radiated at 3 meters at free air conditions with rigid ducts at the inlet and at the outlet.

Air flow regulators

- Independent regulation of desired fresh-/extract air flow
- Eliminates the influence of alternating back pressure, caused by e.g. blocked air filters
- Continuous air flow ensures high comfort inside the cabin
- No electrical or pneumatic wiring
- Direct insertion into the air duct, which allows an easy application



Model	Ø D of ducting	Air flow limit	Order number
Air Flow Regulator 15	80 mm, 3.1 inch	15 m ³ /h, 8.5 cfm	WBCL005243
Air Flow Regulator 30	80 mm, 3.1 inch	30 m ³ /h, 17.5 cfm	WBCL005244
Air Flow Regulator 45	80 mm, 3.1 inch	45 m ³ /h, 26.5 cfm	WBCL005245
Air Flow Regulator 60	80 mm, 3.1 inch	60 m ³ /h, 35 cfm	WBCL005246
Air Flow Regulator 90	100 mm, 4 inch	90 m ³ /h, 53 cfm	WBCL005247
Air Flow Regulator 120	125 mm, 5 inch	120 m ³ /h, 70.5 cfm	WBCL005248
Air Flow Regulator 160	125 mm, 5 inch	160 m ³ /h, 94 cfm	WBCL005249

Accessories for S-, V- and C- Series



- Reduction of electrical starting peak up to 70 %
- For all BlueCool single-phase compressors
- Fully 50/60 Hz compatible for worldwide application
- Self-adjusting software adapts to compressor type and frequency input
- Monitors supply voltage and protects against low voltage and locked rotor
- Easy to install and to retrofit in BlueCool electrical boxes

BlueCool Soft Start

Description	Order number
BlueCool Soft Start 5,000 – 13,000 BTU/h, 230 V, single-phase, 50 – 60 Hz	WBCL050931B
BlueCool Soft Start 16,000 – 20,000 BTU/h, 230 V, single-phase, 50 – 60 Hz	WBCL050932B
BlueCool Soft Start 24,000 – 42,000 BTU/h, 230 V, single-phase, 50 – 60 Hz	WBCL050933B



- Reduction of starting peak up to 53 %
- Fully 50/60 Hz compatible for worldwide application
- Two soft start models cover 3-phase scroll compressors from 21 – 143 kBTU/h
- Self-adjusting software, soft start automatically adapts to compressor
- Monitors supply voltage and protects against overvoltage, overcurrent and locked rotor
- Rated operational voltage: 340 – 440 VACrms, 50/60 Hz

Soft Start 3-phase, 400 V

Description	Order number
Soft Start 21 – 96 kBTU, 400 V, 3-phase, 50 – 60 Hz	WBCL050945A
Soft Start 112 – 143 kBTU, 400 V, 3-phase, 50 – 60 Hz	WBCL050946A

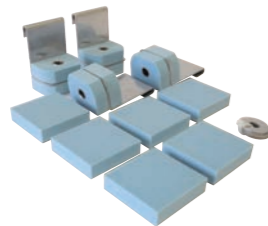

- Reduction of 50 % of vibrations transmitted to the hull
- High performance damping elements specially designed for the vibration frequency and the weight of each unit
- All absorbers can easily be retrofitted and mounted below the condensate tray. One complete kit with all necessary parts is supplied
- The height of the unit will be increased by only 14 mm

BlueCool Vibration absorber kits

Description	Order number
Vibration Absorber Kit S-Series; S6, S8, S10	WBCL120075A
Vibration Absorber Kit S-Series; S13 – S27	WBCL120076A
Vibration Absorber Kit C-Series; C16 M – C27 M	WBCL120078A



- Solution for C-Series with Twin, Triple and Quattro compressors as well as for the V50 M
- One complete kit with all necessary parts is supplied

BlueCool Silent block kits

Description	Order number
Silent Blocks for C32 T, C40 T, C55 T, V50 M, V64 T and V77 T.	WBCL1207041A
Silent Blocks for C81 R and C108 Q	WBCL1207042A

BlueCool Expert Tool

Service software for A/C systems

Free Webasto service software suitable for all new air-conditioning units of the A-/S-/C-/V-/P-Series. Your best companion for easy parameterizing and servicing of the A/C system.

- Plug-and-play USB connection to the A/C unit
 - Standard USB connection
- Remote troubleshooting
 - Remote access via internet
- Easy parameter setting
 - All parameters at one sight
- Back-up and upload of application-specific presets
 - Save individual presets or load standard presets
- Real-time system monitoring
 - Check all data of system while operating
- Access to data logs
 - All relevant data are stored for easy review
- Activation/test of A/C system components
 - Check function of all components and connected accessories

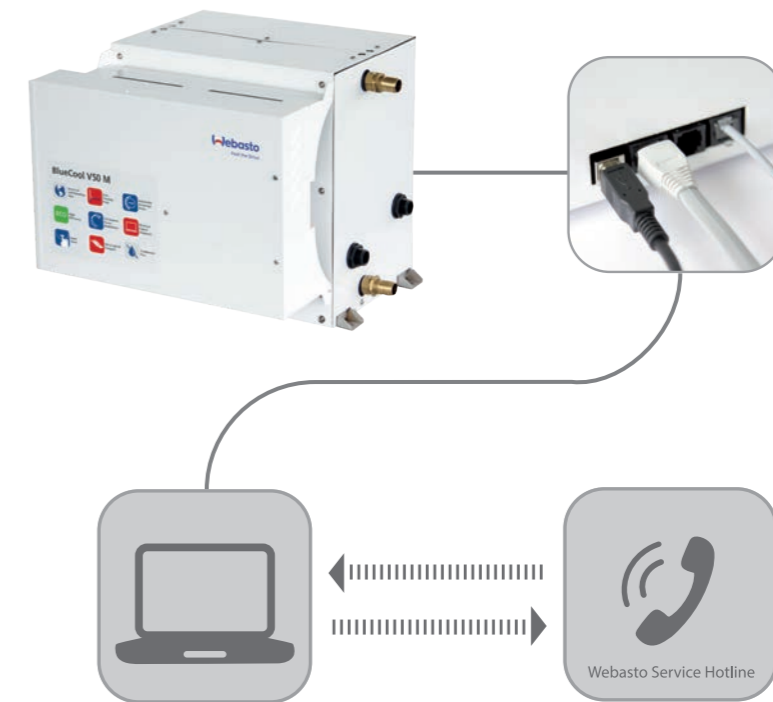

BlueCool Expert Tool

Air conditioning control elements

BlueCool MyTouch



3 different software designs and Webasto cover plate

The BlueCool MyTouch display is the new standard display for all new BlueCool A/C Series and is part of a complete electronic control system including the A/C controller card and connecting cables/sensors.

- Standard display for all BlueCool A/C units
- Full color, high resolution, interactive touch display
- Individual customizable Multi Design Touch Display with 3 different user designs
- Intuitive icons and menus
- 3 different menu levels with
- Easy intuitive operation for end customer
- Advanced settings for crew member
- Complete parameter access for technician with clear text message

Customizable to many cover plate systems like

- Vimar Eikon
- Vimar Eikon EVO
- Vimar Plana
- Btcino Axolute



Air conditioning control elements

BlueCool MyTouch

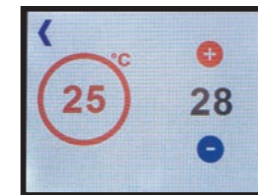

Easy temperature selection with actual cabin temperature (left) and adjustable target temperature (right)

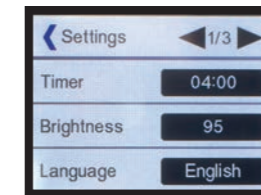

Easy navigation through display settings menu with clear text in 10 languages



Individual picture can be uploaded to be used as Stand-by screen

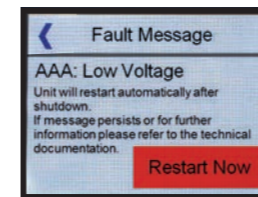

Failure codes show up in clear text

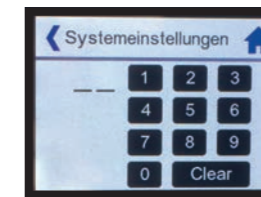



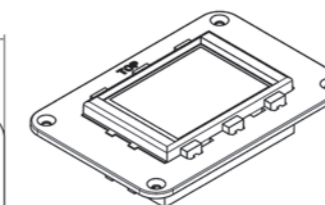
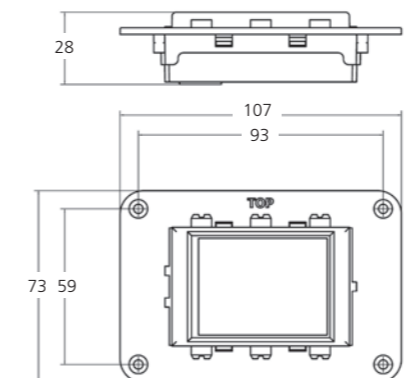
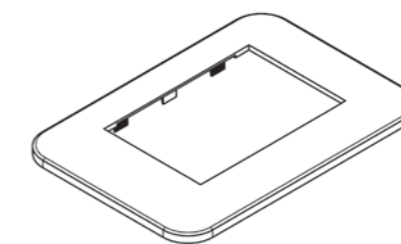
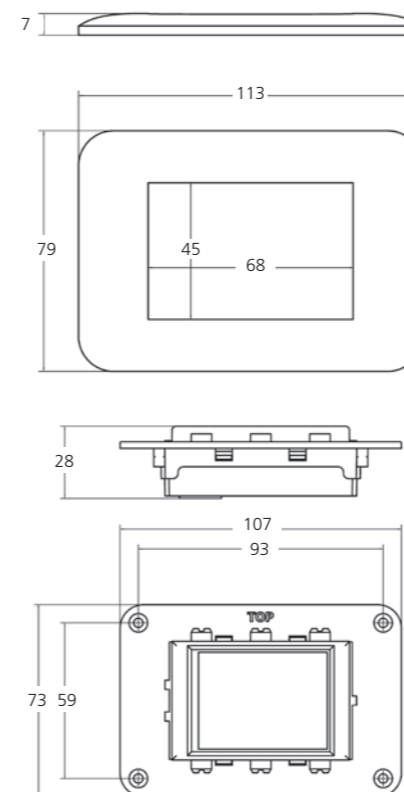



System settings menu is code protected to prevent unwanted changes



Controls





MyTouch Controls

		BlueCool S-Series	BlueCool C-, V-, P-Series	BlueCool A-Series	Order number
	MyTouch Display	✓	■		WBCL151002C
	Cabin Control Kit A-Series Includes: electrical box with controller card, MyTouch display with Webasto cover plate, display cable 5 m, remote air temperature sensor 3 m, max. switching current: 2 x 3.15 A			■*	WBCL151000C
	Ultimate Cabin Control Kit Includes: electrical box with controller card, MyTouch display with Webasto cover plate, display cable 5 m, remote air temperature sensor 3 m, max. switching current: 3.15 A Will be the "Master" unit in a Master-Slave configuration			■*	2510197A
	Ultimate Cabin Control Includes: Electrical box with controller card, max. switching current: 3.15 A Shall be configured as "Slave" unit in a Master-Slave configuration			■	2510198A
	Display cable MyTouch 5 m	✓	■	□	WBCL151001A
	Display cable MyTouch 10 m	□	■	□	WBCL151005A
	Can also be used to create the "Master-Slave" network between Ultimate Cabin Control units				
	Coupling for display cable MyTouch	□	□	□	WBCL151006A
	Can be used to extend MyTouch display cables				
	Remote air temperature sensor with 3 m cable	✓	■**		WBCL000813C
	Remote air temperature sensor with 6 m cable	□	■**	□	WBCL000810C
	Remote air temperature sensor with 12 m cable	□	■**	□	WBCL000812C
	BlueCool CAN-Bus module	□	□	□	WBCL1203091B
	Relay box for 2 units – one pump – 230 V	□	□		WBCL001127C
	Relay box for 3 units – one pump – 230 V	□	□		WBCL001128C
	Relay box for 4 units – one pump – 230 V	□	□		WBCL001129C
	Relay box for 2 units – one pump – 115 V	□	□		WBCL001182B
	Relay box for 3 units – one pump – 115 V	□	□		WBCL001183B

✓ Already included in scope of delivery ■ Mandatory accessory □ Optional accessory
 * A-Series air handler may also be connected to chiller control directly. In this case no cabin control kit is needed.
 ** Required if chiller shall run in automatic mode or if air handlers are connected to the chiller electronics.

Controls

Digital Controls

		BlueCool FreshAir	Order number
	Digital Control Panel including Bezel	□	WBCL000833D
	Fresh Air control kit V3 230 V, 4.5 m display cable, for 24,000 BTU/h*	□	WBCL000217G
	Fresh Air control kit V3 230 V, 4.5 m display cable, for 48,000 BTU/h*	□	WBCL000221G
	Display cable between A/C control unit and digital control panel – 4.5 m	□	WBCL000815B
	Display cable between A/C control unit and digital control panel – 6 m	□	WBCL000808B
	Display cable between A/C control unit and digital control panel – 12 m	□	WBCL000809B
	Display cable between A/C control unit and digital control panel – 20 m	□	WBCL000805
	Remote air temperature sensor with 3 m cable	□	WBCL000813C
	Remote air temperature sensor with 6 m cable	□	WBCL000810C
	Remote air temperature sensor with 12 m cable	□	WBCL000812C
	CANbus interface	□	WBCL010127A

✓ Already included in scope of delivery ■ Mandatory accessory □ Optional accessory
 * Includes: electrical box with controller card, digital control panel with bezel, display cable.

Self-priming pumps

Model	Dimensions L x W x H	Max. output	Running power consumption	Connection in, out	Weight	Order number 115 V	Order number 230 V	Order number 400 V
Self priming pumps 50/60 Hz								
WB200 • *	195 x 130 x 130 mm 7.7 x 5.2 x 5.2 inch	12/3.2 (l/min.) 3.2/0.9 (gpm)	25 W 0.2 amps (230 V)	5/8", 16 mm	1.2 kg 2.7 lbs	-	WBCL001103B	-
Self priming bronze pumps 50/60 Hz								
WB500G	254 x 120 x 185 mm 10,0 x 4,7 x 7,3 inch	18 (l/min.) 4.7 (gpm)	250 W 1.2 amps (230 V)	G 1/2" F G 1/2" F	6.2 kg	WBCL001306A	WBCL001305A	-
WB1000G	260 x 120 x 143 mm 10.3 x 4.8 x 5.7 inch	60 (l/min.) 15.8 (gpm)	370 W 1.7 amps (230 V)	G 3/4" F G 3/4" F	6.5 kg 14.4 lbs	WBCL001307A	WBCL001092A	-
WB3800G	410 x 215 x 230 mm 16.1 x 8.5 x 9.1 inch	120 (l/min.)	1200 W 5.8 amps (230 V)	G 1 1/4" F	21 kg	-	WBCL001094A	-
Self priming pumps 50 Hz								
WB8000*	592 x 215 x 302 mm 23.4 x 8.5 x 11.9 inch	500 (l/min.) 132 (gpm)	1,600 W 2.9 amps (400 V)	G 2" F G 2" F	19 kg 41.9 lbs	-	-	WBCL001164A
WB10500*	592 x 215 x 302 mm 23.4 x 8.5 x 11.9 inch	667 (l/min.) 176 (gpm)	3,000 W 5.3 amps (400 V)	G 2" F G 2" F	21 kg 46.3 lbs	-	-	WBCL001165A

• Contains straight hose nipple 5/8", 16 mm and 90° adaptor for hose nipple

* Can only be used for sea water cooling, not for chilled water circulation

For a stable operation of A/C systems it is essential to have a robust sea water flow in order to cool the condenser and avoid high pressure cut outs of the A/C unit. The sea water pump has to provide this water flow through the A/C unit.

As soon as a significant amount of air is being sucked into the sea water circuit most standard circulation pumps do not have the technical capability to evacuate these air bubbles once they enter into the pump chamber. As a result, the sea water flow stops and the A/C system will shut off. Self priming pumps do have this capability to evacuate these air bubbles from the pump chamber thus ensuring a continuous A/C operation. Therefore they are the best choice for all those boats and applications where there is a certain risk that air bubbles might enter via the through hull fitting.

Please note that even though the sea water intake fitting is mounted below the sea water line it may happen during heeling, high boat speed or during reversing the boat that air is being sucked into the sea water intake. For such applications it is highly recommended to use self priming sea water pumps instead of standard circulation pumps.

The pump models WB500G, WB1000G and WB3800G have to be pre-filled before the first start-up and after long downtimes.

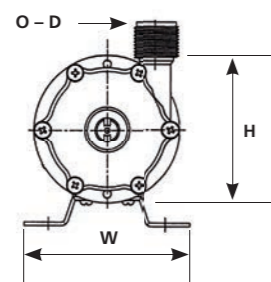
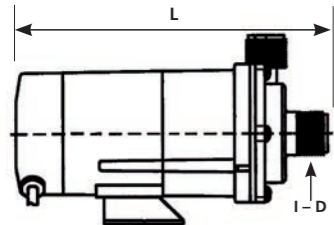

Model WB200



Model WB500G/1000G/2800G



Model WB8000/10500

Pumps

Model	Dimensions L x W x H	Max. output ***	Running power consumption	Connection in, out	Weight	Order number 115 V	Order number 230 V	Order number 400 V
Magnetic Drive Pumps 50/60 Hz								
WB250	180 x 95 x 109 mm 7.1 x 3.7 x 4.3 inch	16 (l/min.) 4.2 (gpm)	26 W, 0.36 amps (115 V) 0.18 Amps (230 V)	Ø 14 mm Ø 14 mm	1.6 kg 3.3 lbs	WBCL001301	WBCL001104A	-
	179 x 95 x 114 mm 7.1 x 3.7 x 4.3 inch	16 (l/min.) 4.2 (gpm)	26 W 0.2 Amps (230 V)	G 3/4" M G 3/4" M	1.6 kg 3.3 lbs	-	WBCL010799B*	-
WB350	209 x 106 x 105 mm 8.2 x 4.2 x 4.2 inch	27 (l/min.) 7.1 (gpm)	40 W, 0.48 Amps (115 V) 0.24 Amps (230 V)	Ø 18 mm Ø 17 mm	2 kg 4.4 lbs	WBCL001302A	WBCL001105A	-
	203 x 106 x 107 mm 8.1 x 4.2 x 4.2 inch	27 (l/min.) 7.1 (gpm)	45 W 0.24 Amps (230 V)	G 3/4" M G 3/4" M	2 kg 4.4 lbs	-	WBCL0010800A*	-
WB500	248 x 120 x 130 mm 9.8 x 4.8 x 5.2 inch	32 (l/min.) 8.4 (gpm)	60 W 0.4 Amps (230 V)	G 3/4" M G 3/4" M	3.5 kg 7.8 lbs	2510180A	WBCL001101A	-
	248 x 120 x 130 mm 9.8 x 4.8 x 5.2 inch	32 (l/min.) 8.4 (gpm)	60 W 0.4 Amps (230 V)	G 3/4" M G 3/4" M	3.5 kg 7.8 lbs	-	WBCL0010810A*	-
WB1000	250 x 120 x 130 mm 9.9 x 4.8 x 5.2 inch	45 (l/min.) 11.8 (gpm)	90 W, 1 Amps (115 V) 0.52 Amps (230 V)	G 3/4" M G 3/4" M	3.9 kg 8.6 lbs	WBCL001303A	WBCL001106A	-
WB1500	258 x 130 x 155 mm 10.2 x 5.2 x 6.1 inch	86 (l/min.) 22.7 (gpm)	235 W 1.21 Amps (230 V)	G 1" M G 1" M	6 kg 13.2 lbs	WBCL001304	WBCL001107A	-
WB2000	322 x 156 x 175 mm 12.7 x 6.2 x 6.9 inch	115 (l/min.) 30.3 (gpm)	345 W 1.93 Amps (230 V)	G 1" M G 1" M	8,5 kg 18.8 lbs	-	WBCL001108A	-
Magnetic Drive Pumps 50/60 Hz								
WB3500	423.5 x 149 x 210 mm 16.7 x 5.9 x 8.3 inch	280 (l/min.) 74 (gpm)	370 W, 2.4 Amps (230 V) 1.1 Amps (400 V)	G 1 1/2" M 1 1/2" M	14 kg 30.9 lbs	-	WBCL001109A	WBCL001111A
WB5500	473 x 160 x 249 mm 18.9 x 6.3 x 9.8 inch	320 (l/min.) 84.6 (gpm)	750 W, 3.3 Amps (230 V) 1.8 Amps (400 V)	G 1 1/2" M 1 1/2" M	22 kg 48.5 lbs	-	WBCL001110A	WBCL001112A
WB7400	478.5 x 260 x 274 mm 20.1 x 10.3 x 10.8 inch	450 (l/min.) 118.8 (gpm)	1,500 W, 7.1 Amps (230 V) 3.1 Amps (400 V)	G 2" M G 1 1/2" M	25 kg 55.2 lbs	-	WBCL010121A	WBCL001138
WB9800	478.5 x 260 x 274 mm 22.1 x 10.3 x 10.8 inch	520 (l/min.) 137.4 (gpm)	2,200 W 4.5 Amps (400 V)	G 2" M G 1 1/2" M	32 kg 70.5 lbs	-	-	WBCL001139A
Bronze Pump 50 Hz								
WB7500**	382 x 190 x 250 mm 15.1 x 7.5 x 9.9 inch	400 (l/min.) 105.7 (gpm)	2,000 W 4.5 Amps (400 V)	G 2" F G 1 1/4" F	23 kg 50.7 lbs	-	-	WBCL001136
Bronze Pump 60 Hz								
WB7500**	382 x 190 x 250 mm 15.1 x 7.5 x 9.9 inch	400 (l/min.) 105.7 (gpm)	2,000 W 4.5 Amps (400 V)	G 2" F G 1 1/4" F	23 kg 50.7 lbs	-	-	WBCL001137A
Bronze Pumps 50/60 Hz								
WB2500G	303 x 154 x 161 mm 11.9 x 6.1 x 6.4 inch	80 (l/min.) 21.1 (gpm)	550 W 2.5 Amps (230 V)	G 1" F G 1" F	9 kg 19.9 lbs	-	WBCL001170A	-
WB3000G	303 x 174 x 181 mm 11.9 x 6.9 x 7.2 inch	125 (l/min.) 33 (gpm)	1,100 W, 4.9 Amps (230 V) 2.8 Amps (400 V)	G 1" F G 1" F	10 kg 22.1 lbs	-	WBCL001171A	WBCL001172A
WB5500G	380 x 193 x 240 mm 15 x 7.6 x 9.5 inch	250 (l/min.) 66 (gpm)	1,500 W, 6.7 Amps (230 V) 4.5 Amps (400 V)	G 1 1/2" F G 1 1/2" F	17 kg 37.5 lbs	-	WBCL001173A	WBCL001174A

* White painted version with threaded hose connections ** Can only be used for chilled water circulation, not for sea water cooling.

*** Effective water output varies with back pressure. Please respect the pump curves on the next pages in order to ensure the minimum water flows required for your applications.
Note: F = Female thread in inch M = Male thread in inch



WB250 to WB1000



WB1500 to WB2000



WB3500 to 9800



WB2500G to 5500G

Pumps

50 Hz water pump curves

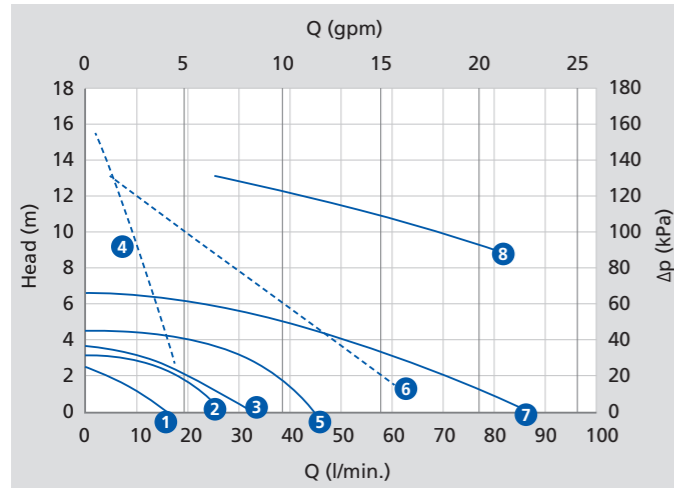

Graphic 1	50 Hz up to 100 l/min.
1	WB250
2	WB350
3	WB500
4	WB500G
5	WB1000
6	WB1000G
7	WB1500
8	WB2500G

— Centrifugal - - - Self-priming

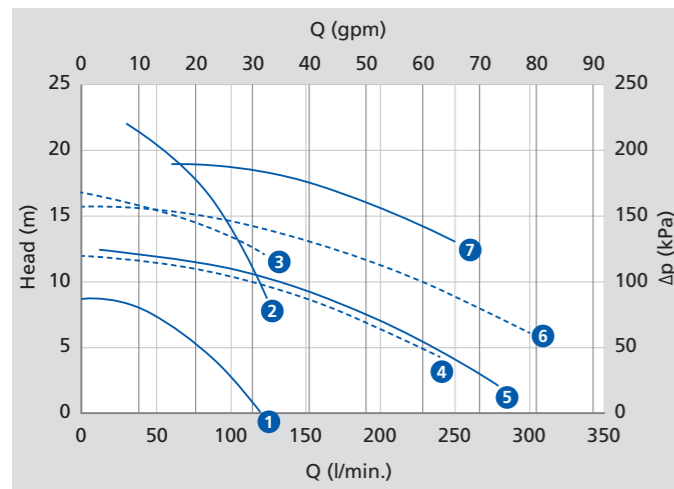

Graphic 2	50 Hz up to 300 l/min.
1	WB2000
2	WB3000G
3	WB3800G
4	WB4000
5	WB3500
6	WB5600
7	WB5500G

— Centrifugal - - - Self-priming

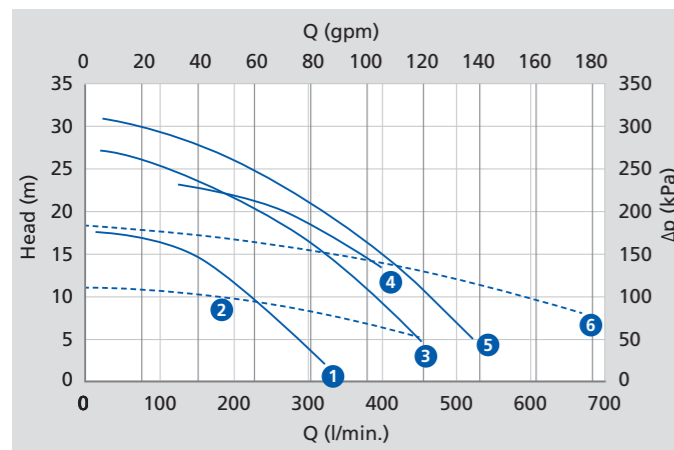

Graphic 3	50 Hz up to 700 l/min.
1	WB5500
2	WB8000
3	WB7400
4	WB7500
5	WB9800
6	WB10500

— Centrifugal - - - Self-priming

Pumps

60 Hz water pump curves

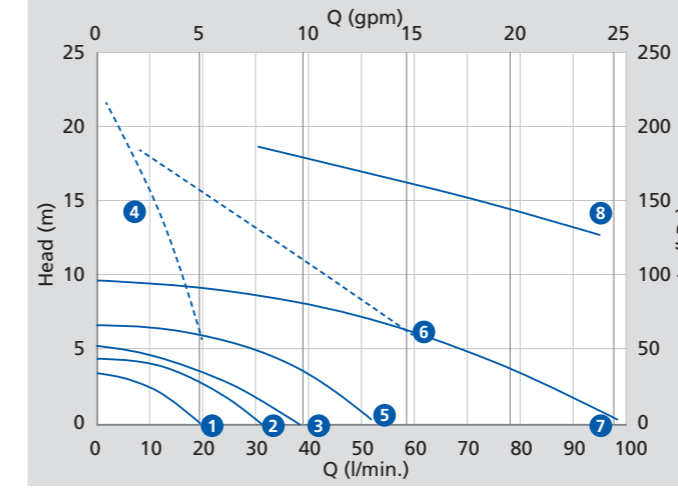

Graphic 4	60 Hz up to 100 l/min.
1	WB250
2	WB350
3	WB500
4	WB500G
5	WB1000
6	WB1000G
7	WB1500
8	WB2500G

— Centrifugal - - - Self-priming

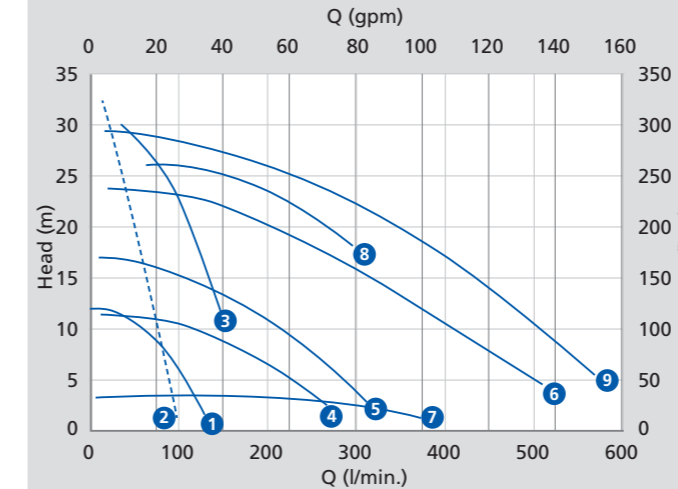

Graphic 5	60 Hz up to 700 l/min.
1	WB2000
2	WB2800G
3	WB3000G
4	WB3500
5	WB5500
6	WB7400
7	WB7500
8	WB5500G
9	WB9800

— Centrifugal - - - Self-priming

- The Head (m) stated in the pump curves (Graphic 1 – 5) represents the equivalent pressure drop between inlet and outlet of the pump. This pressure drop equals the total back pressure of the sea water system from sea water entry to overboard discharge. Please do not confuse it with the position of the pump position below the water line.
- Depending on pressure drop the effective water flow through the pump and thus the sea water system varies significantly.
- Always ensure that the minimum sea water flow through the A/C unit is respected. It should be measured during each commissioning of the system.
- Operating the pumps outside the limits of the pump curves may result in motor overload or cavitation. These cases are excluded from Webasto warranty.

Air system

Functioning principals

Minimum air grille sections

To obtain acceptable noise levels at maximal blower speed levels the requirements for grille and ducts sections should be observed. The size of the transition box behind the supply air-grille is also important.

Capacity BlueCool A/C component	Duct size S-Series (mm)	Duct size A-Series (mm)	Supply air grill (cm ²)	Recommended supply air grill (")	Return air grill (cm ²)	Recommended return air grill (")
4,000 BTU/h	–	100	150	8 x 4	325	12 x 5
6,000 BTU/h	–	125	190	10 x 4	490	11 x 8
8,000 – 10,000 BTU/h	100 – 125	125	235	12 x 4	490	11 x 8
12,000 – 13,000 BTU/h	125 – 150	150	250	10 x 5	550	14 x 7
16,000 – 20,000 BTU/h	125 – 150	150	390	12 x 6	800	14 x 10
24,000 BTU/h	–	2 x 150	2 x 250	2 x 10 x 5	1,000	14 x 12
27,000 BTU/h	2 x 150	–	650	2 x 12 x 6	1,600	2 x 14 x 10
36,000 BTU/h	–	2 x 150	2 x 380	2 x 12 x 6	1,600	2 x 14 x 10

Blower outlets

90° turns with flexible ducts directly from blower outlets should be avoided at all costs as they introduce severe restrictions in the air-flow. All WB blowers (except on 24,000 BTU/h models) can be rotated through 45° steps to obtain a straight-line outlet from the blower. This facility should be used whenever possible.

Return grille offset

It should be avoided to place a return air grille directly opposite the finned coil surface of an air handler, because this will allow propagation of direct blower-motor noise through the grille. The grille should be offsetted to chicane the return air to the coil inlet. Direct noise propagation will be reduced in a significant manner.





Duct type

To avoid accidental crushing, flexible air-ducts should be of high quality with sufficiently strong steel spiral reinforcement. Spiral type ducts should be extended to their maximum length for the best interior smoothness. For very long duct sections smooth bore ducts (in PVC for example) should be preferred. This offers better smoothness than flexible spiral type ducting and hence reduces internal friction. For very short lengths non-insulated ducts can be used. For greater lengths it is advisable to use insulated type ducts to avoid condensation on the outside of the air-ducts.

Big luxury yacht

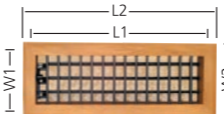
In general requirements for megayachts and big luxury vessels are even more stringent than the table here above. These special requirements can be obtained from Webasto on request.

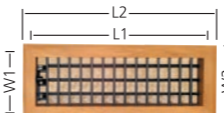
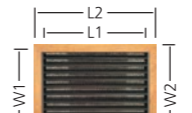
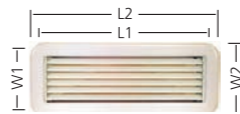
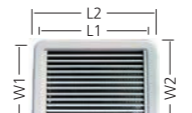
Air system

Air grille*	Model	L1 (mm)	L2 (mm)	W1 (mm)	W2 (mm)	Order number
	8 x 4 TS (supply air)	202	230	100	128	WBCL004000XA
	10 x 4 TS	252	281	100	128	WBCL004001XA
	12 x 4 TS	304	332	100	128	WBCL004002XA
	10 x 5 TS	252	281	125	152	WBCL004018XA
	12 x 5 TS	304	332	125	152	WBCL004004XA
	12 x 6 TS	304	332	152	179	WBCL0040240A
Wedge type supply air grille*	Model	L1 (mm)	L2 (mm)	W1 (mm)	W2 (mm)	Order number
	10 x 5 WGT (supply air)	–	280	–	150	WBCL004023XA
Air grille, closeable*	Model	L1 (mm)	L2 (mm)	W1 (mm)	W2 (mm)	Order number
	8 x 4 TSC (supply air)	202	230	100	128	WBCL004005XA
	10 x 4 TSC	252	281	100	128	WBCL004019XA
	12 x 4 TSC	304	332	100	128	WBCL004006XA
	10 x 5 TSC	252	281	125	152	WBCL004022XA
	12 x 5 TSC	304	332	125	152	WBCL004025XA
Air grille with filter*	Model	L1 (mm)	L2 (mm)	W1 (mm)	W2 (mm)	Order number
	12 x 5 TR (return air)	304	332	125	152	WBCL004020XA
	11 x 8 TR	280	306	204	230	WBCL004017XA
	14 x 7 TR	177	205	355	381	WBCL004007XA
	12 x 10 TR	304	332	254	281	WBCL004021XA
	14 x 10 TR	354	382	254	281	WBCL004008XA
	14 x 12 TR	354	382	304	332	WBCL004009XA
Air grille (ABS)	Model	L1 (mm)	L2 (mm)	W1 (mm)	W2 (mm)	Order number
	10 x 4 PS (ABS, supply air)	242	280	92	128	WBCL004030A
	12 x 4 PS	292	332	92	128	WBCL004031A
	10 x 5 PS	242	280	115	152	WBCL004032A
	10 x 6 PS	242	280	138	174	WBCL004033A
Air grille (ABS) with filter	Model	L1 (mm)	L2 (mm)	W1 (mm)	W2 (mm)	Order number
	10 x 8 PR (ABS, return air)	242	281	190	232	WBCL004076A
	10 x 10 PR	242	281	242	281	WBCL004077A
	12 x 12 PR	292	332	292	332	WBCL004078A
	14 x 10 PR	342	382	242	281	WBCL004080A
	14 x 12 PR	342	382	292	332	WBCL004081A
Round, adjustable plastic grille	Model					Order number
	Black, 100 mm			–		WBCL004090A
	Walnut brown, 100 mm			–		WBCL004091A
	White, 100 mm			–		WBCL004092A
	Off-white, 100 mm			–		WBCL004093A
	White, 75 mm			–		WBCL004094A
	White, 75 mm with hose ring			–		WBCL004095A
	Black, 75 mm with hose ring			–		WBCL004096A
	Black, 75 mm			–		WBCL004097

* Note: All teak grilles can be supplied in other wood qualities on demand. Please see table listing the special suffixes to the chosen grille item code in accordance with the wood type preference.

In order to customise the wooden air grilles, please choose from the following wood options:

Example: WBCL0040040 = Teak air grille 12 x 5 WBCL0040042 = Mahogany air grille 12 x 5

Suffix	Wood type	Description
0	Teak	Asian Teak
1	Cherry	American Cherry
2	Mahogany	Honduran Mahogany
4	Oak	American white Oak

Note: Teak versions on stock. Other wood options may have longer lead times or extra shipping costs.

Air system

T-piece (inside, D2 direct to A/C unit)	Model	D1/D2/D3 (mm)	L x H (mm)		Order number
	100/100 F/100	100/100 F/100	220 x 185	-	WBCL001549A
	100/125 F/100	125/100 F/100	220 x 185	-	WBCL001560A
	125/125 F/100	125/125 F/100	220 x 185	-	WBCL001550A
	125/125 F/125	125/125 F/125	220 x 185	-	WBCL001555A
T-piece (outside, D2 connected to hose)	Model	D1/D2/D3 (mm)	L x H (mm)		Order number
	100/100 M/100	100/100 M/100	220 x 185	-	WBCL001551A
	100/125 M/100	100/125 M/100	220 x 185	-	WBCL001552A
Y-piece (inside, D2 direct to A/C unit)	Model	D1/D2/D3 (mm)	L x H (mm)		Order number
	100/125 F/100	100/125 F/100	269 x 213	-	WBCL001576A
	100/125 F/125	100/125 F/125	269 x 213	-	WBCL001577A
Y-piece (outside, D2 connected to hose)	Model	D1/D2/D3 (mm)	L x H (mm)		Order number
	100/100 M/100	100/110 M/100	250 x 200	-	WBCL001578A
	100/125 M/100	100/125 M/100	269 x 213	-	WBCL001574A
	100/125 M/125	100/125 M/125	269 x 213	-	WBCL001575A
	125/150 M/125	125/150 M/125	280 x 220	-	WBCL001580A
	150/150 M/150	150/150 M/150	280 x 220	-	WBCL001581A
Hose adapter	Model	D1/D2/D3 (mm)	L x H (mm)		Order number
	3" x 4"	106 x 70	106 x 70	-	WBCL001579A
90 degree elbow-piece, D2 connected to A/C unit	Model	D1/D2 (mm)	L x H (mm)		Order number
	100 M/100 F	100 M/100 F	173 x 172	-	WBCL001572A
	125 M/125 F	125 M/125 F	194 x 198	-	WBCL001573A
90 degree elbow-piece, D2 connected to hose	Model	D1/D2 (mm)	L x H (mm)		Order number
	100 M/100 M	100 M/100 M	170 x 170	-	WBCL001570A
	125 M/125 M	125 M/125 M	195 x 195	-	WBCL001571A
Standard transition box	Model		L x H (mm)	W (mm)	Order number
	8 x 4"	-	252 x 130	150	WBCL001501A
	10 x 4"	-	304 x 130	150	WBCL001502A
	12 x 4"	-	352 x 130	150	WBCL001503A
	12 x 5"	-	352 x 130	180	WBCL001505A
	10 x 5"	-	304 x 130	180	WBCL001506A
	12 x 6"	-	352 x 130	200	WBCL001507A
	10 x 6"	-	304 x 130	200	WBCL001508A
Standard hose rings	Model	D (mm)		W (mm)	Order number
	HR4 - 100	100	-	134	WBCL002502
	HR5 - 125	125	-	150	WBCL002503
	HR6 - 150	150	-	170	WBCL002504A
	HR7 - 178	175	-	200	WBCL002509A
Oval hose rings	Model	D x W2 (mm)	L x H (mm)	W1 (mm)	Order number
	HO4 - 100*	120 x 55	170	100	WBCL002505A
	HO5 - 125*	150 x 65	195	110	WBCL002506A
	HO6 - 150*	180 x 72	228	120	WBCL002507A
	HO7 - 175*	200 x 84	255	140	WBCL002508A
Transition box, round entry	Model	D (mm)	L x H (mm)	W (mm)	Order number
	8 x 4LN/100*	100	250 x 130	150	WBCL001520A
	10 x 4LN/100*	100	305 x 130	150	WBCL001521A
	12 x 4LN/100*	100	360 x 130	150	WBCL001522A
	10 x 5LN/125*	125	304 x 130	180	WBCL001523A

F = Female M = Male
* Equivalent diameter of air ducting in mm

Air system

Transition box, lateral oval entry	Model	D x W2 (mm)	L x H (mm)	W (mm)	Order number
	8 x 4LT/OV100*	120 x 55	250 x 130	155	WBCL001510A
	10 x 4LT/OV100*	120 x 55	305 x 130	155	WBCL001530A
	10 x 4LT/OV125*	150 x 65	305 x 130	155	WBCL001529A
	12 x 4LT/OV125*	150 x 65	305 x 130	180	WBCL001528A
Transition box, back oval entry	Model	D x W2 (mm)	L x H (mm)	W (mm)	Order number
	8 x 4AR/OV100*	120 x 55	250 x 180	155	WBCL001524A
	10 x 4AR/OV100*	120 x 55	305 x 180	155	WBCL001525A
	10 x 4AR/OV125*	150 x 65	305 x 180	155	WBCL001531A
	10 x 5AR/OV125*	150 x 65	305 x 180	180	WBCL001526A
	10 x 6AR/OV125*	150 x 65	305 x 180	205	
Y-piece	Model	D/D1/D2 (mm)	L x H (mm)		Order number
	YAS100	100/100/100	320 x 255	-	WBCL001562A
	YAS125	125/125/125	360 x 300	-	WBCL001563A
	YAS100/80/80	100/80/80	380 x 300	-	WBCL001548A
Webasto EasyDuct - Insulated flexible air ducts	Model (mm)	D (mm)	L (m)		Order number
	80	IN = 80; A = 90	L = 6	-	WBCL007463A
	102	IN = 102; A = 112	L = 6	-	WBCL007464A
	127	IN = 127; A = 137	L = 6	-	WBCL007465A
	152	IN = 152; A = 162	L = 6	-	WBCL007472A
Standard flexible air ducts	Model (mm)	D (mm)	L (m)		Order number
	Cflex 102	102	10	-	WBCL001804B
	Cflex 127	127	10	-	WBCL001805B
	Cflex 150	152	10	-	WBCL001806B
Insulated flexible air ducts	Model	D (mm)	L (m)		Order number
	Cflexiso 102	102	10	-	WBCL001807B
	Cflexiso 127	127	10	-	WBCL001808B
	Cflexiso 152	152	10	-	WBCL001809B
Tubular hose insulation	Model	D (mm)	L (m)		Order number
	Isosleeve 102	102	10	-	WBCL001810
	Isosleeve 127	127	10	-	WBCL001811
	Isosleeve 152	152	10	-	WBCL001812
Extra silent insulated air ducts		D (mm)	L (m)		Order number
	-	102	10	-	WBCL010155A
	-	127	10	-	WBCL010156A
	-	160	10	-	WBCL010206A

* Equivalent diameter of air ducting in mm.

Air system

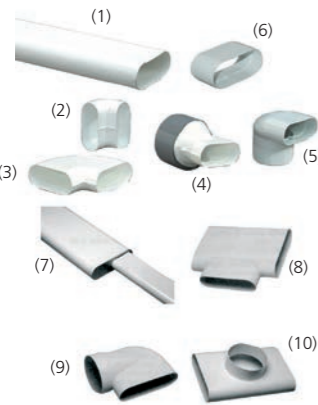
Oval ducts	Description	Model (mm)	L (m)	Order number
	Oval duct (1)	100 x 40	3	WBCL007100
	Oval duct (1)	200 x 60	3	WBCL007106
	Elbow 90° (2)	100 x 40	-	WBCL007105
	Elbow 90° (2)	200 x 60	-	WBCL007108
	Elbow 90° - flat (3)	100 x 40	-	WBCL007104
	Elbow 90° - flat (3)	200 x 60	-	WBCL007111
	Junction oval/round (4)	100 x 40/100	-	WBCL007102A
	Junction oval/round (4)	100 x 40/80	-	WBCL007117
	Junction oval/round (4)	200 x 60/125	-	WBCL007109
	Junction oval/round (5)	100 x 40/100	-	WBCL007103A
Junction oval/round (5)	200 x 60/125	-	WBCL007110	
Junction oval (6)	100 x 40	-	WBCL007101	
Junction oval (6)	200 x 60	-	WBCL007107	
Reduction (7)	200 to 100	-	WBCL007112	
Oval t (8)	200 x 60	-	WBCL007114	
Adapter oval/round (9)	200 x 60/125	-	WBCL007115	
Oval/round t (10)	200 x 60/125	-	WBCL007116	

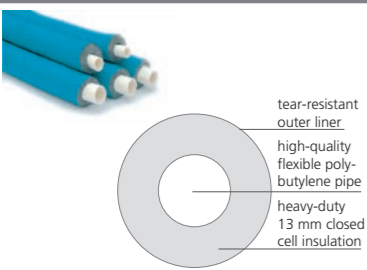
Water System	Chilled water pipes Webasto EasyPipe (mm)	Model (mm)	Packaging (m)	Order number
	d15/D4	15	50	WBCL010122B
	d22/D48	22	25	WBCL010123B
	d28/D54	28	25	WBCL010124B

Webasto EasyPipe

The solution to reduce installation time and save costs!

Benefits

- Easy assembly process, reliable application
- Pipes have pre-mounted insulation providing significant saving on installation time for boat builders
- Huge range of compatible quick-fitting components

Specifications

- Pipe material is high-quality polybutylene with a temperature range of -30°C up to 90°C at 6 bar
- Pipe insulation is high-quality closed cell polyethylen (PE-LD) with a temperature range of -30°C to 95°C and a lambda value of 0.0334 W/(m · K)
- O-ring sealed push fittings with stainless steel lockring
- Sold in rolls to be cut to length

Water System	Description	Model (mm)	Packaging (m)	Order number
	Hep_O PB Barrier Pipe	15	L = 50	WBCL010300B
	Hep_O PB Barrier Pipe	22	L = 50	WBCL010301B
	Hep_O PB Barrier Pipe	28	L = 25	WBCL010302B



Water system

	Description	Model (mm)	Packaging (pieces)	Order number
	Hep_O Straight Connector 15	15	10	WBCL010307B
	Hep_O Straight Connector 22	22	10	WBCL010308B
	Hep_O Straight Connector 28	28	10	WBCL010309B
	Hep_O PB Elbow 90° 15	15	10	WBCL010325B
	Hep_O PB Elbow 90° 22	22	10	WBCL010326B
	Hep_O PB Elbow 90° GY 28	28	10	WBCL010327B
	Hep_O PB Tee 90° 15	15 x 15 x 15	10	WBCL010337B
	Hep_O PB Tee 90° 22	22 x 22 x 22	10	WBCL010338B
	Hep_O PB Tee 90° GY 28	28 x 28 x 28	10	WBCL010342B
	Hep_O PB Tee 90° 22 x 22 x 15	22 x 22 x 15	5	WBCL010339B
	Hep_O PB Tee 90° 22 x 15 x 22	22 x 15 x 22	5	WBCL010340B
	Hep_O PB Tee 90° 22 x 15 x 15	22 x 15 x 15	5	WBCL010341B
	Hep_O PB Tee 90° 28 x 15	28 x 15 x 28	5	WBCL010343B
	Hep_O PB Tee 90° 28 x 28 x 22	28 x 28 x 22	5	WBCL010344B
	Hep_O PB Tee 90° 28 x 22 x 28	28 x 22 x 28	5	WBCL010345B
	Hep_O Pb Tee Reduced Both Ends	W 22 x 15	-	WBCL010700A
	Hep_O Pb Tee Reduced Both Ends	W 28 x 15	-	WBCL010701A
	Hep_O Hepkey Plus 15	-	-	WBCL010702A
	Hep_O Hepkey Plus 22	-	-	WBCL010703A
	Hep_O Hepkey Plus 28	-	-	WBCL010704A
	Hep_O Silicone Lubricant Spray 400 ml Aerosol Can Hep_O Fittings	-	-	WBCL010705A

Water system



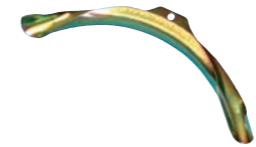

	Description	Model (mm)	Packaging (pieces)	Order number
	Hep ₂ O reducer 22 x 15 S/SP	22 x 15	10	WBCL010379B
	Hep ₂ O reducer 28 x 22 S/SP	28 x 22	10	WBCL010380B
	Hep ₂ O Straight Tap Connector 15 x 1/2"	15 x 1/2"	10	WBCL010316B
	Hep ₂ O Straight Tap Connector 15 x 3/4"	15 x 3/4"	5	WBCL010317B
	Hep ₂ O Straight Tap Connector 22 x 3/4"	22 x 3/4"	5	WBCL010318B
	Hep ₂ O Bent Tap Connector 15 x 1/2"	15 x 1/2"	10	WBCL010328B
	Hep ₂ O Brass Female Adapt 15 x 1/2"	15 x 1/2"	10	WBCL010310B
	Hep ₂ O Brass Female Adapt 22 x 3/4"	22 x 3/4"	10	WBCL010312B
	Hep ₂ O Brass Female Adapt 28 x 1"	28 x 1"	10	WBCL010314B
	Hep ₂ O Brass Male Adapt 15 x 1/2"	15 x 1/2"	10	WBCL010311B
	Hep ₂ O Brass Male Adapt 22 x 3/4"	22 x 3/4"	10	WBCL010313B
	Hep ₂ O Brass Male Adapt 28 x 1"	28 x 1"	10	WBCL010315B
	Hep ₂ O Brass Spgt Adapt 15 x 1/2" Female	15 x 1/2"	10	WBCL010319B
	Hep ₂ O Brass Spgt Adapt 22 x 3/4" Female	22 x 3/4"	10	WBCL010321B
	Hep ₂ O Brass Spgt Adapt 28 x 1" Female	28 x 1"	10	WBCL010323B
	Hep ₂ O Brass Spgt Adapt 15 x 1/2" Male	15 x 1/2"	10	WBCL010320B
	Hep ₂ O Brass Spgt Adapt 22 x 3/4" Male	22 x 3/4"	10	WBCL010322B
	Hep ₂ O Brass Spgt Adapt 28 x 1" Male	28 x 1"	10	WBCL010324B
	Hep ₂ O Brass Ball Valve 15	15	5	WBCL010353B
	Hep ₂ O Brass Ball Valve 22	22	5	WBCL010354B
	Hep ₂ O Shut off valve Hot/Cold 15	15	5	WBCL010375B

Water system

	Description	Model (mm)	Packaging (pieces)	Order number
	Hep ₂ O Cold Forming Bend Fixture 15	15	5	WBCL010335B
	Hep ₂ O Cold Forming Bend Fixture 22	22	5	WBCL010336B
	Hep ₂ O Pipe Support Sleeve 15	15	10	WBCL010362B
	Hep ₂ O Pipe Support Sleeve 22	22	10	WBCL010364B
	Hep ₂ O Pipe Support Sleeve 28	28	5	WBCL010366B
	Hep ₂ O Pipe cutter 10 – 28 Standard	–	1	WBCL010373B
	Hep ₂ O Pipe cutter 10 – 28 Professional	–	1	WBCL010374B

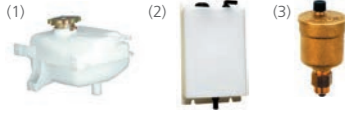
Important Note:
ALL Hep₂O FITTINGS ARE PRE-LUBRICATED – NO ADDITIONAL LUBRICATION REQUIRED.
 If the fitting is demounted and remade, the use of Hep₂O Silicone Lubricant Spray (HX200) is recommended.
 HX200 is the only lubricant recommended for use with Hep₂O.

Water system

	Expansion tank	Order number
	Model 2,5 liter (1)	WBCL002030
	Model 8 liter (2)	WBCL002031B
	Automatic air bleeder (3) for chiller circuits, 3/8" = 15 mm	WBCL002035A
	TA Hydronics flow regulators	Order number
	Model STAD-15 – diameter 15 mm (5/8")	WBCL002100
	Model STAD-20 – diameter 20 mm (3/4")	WBCL002101
	Model STAD-25 – diameter 25 mm (1")	WBCL002102
	3-Way valve	Order number
	3-Way valve 25 mm (1") without fitting (1)	WBCL009433
	3-Way valve 15 mm (5/8") without fitting (1)	WBCL009434
	3-Way valve 20 mm (3/4") without fitting (1)	WBCL009432
	Turn ball valve	Order number
	1/4 Turn ball valve – diameter 12 mm	WBCL002015A
	1/4 Turn ball valve – diameter 15 mm	WBCL002016A
	1/4 Turn ball valve – diameter 20 mm	WBCL002017A
	1/4 Turn ball valve – diameter 25 mm	WBCL002018A

Water system

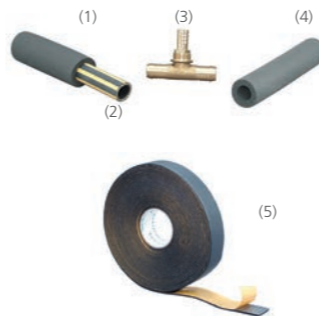
	Chilled water hoses and accessories	Order number
	Hose D12 with insulation 9 x 18 mm – 25 m (1)	WBCL002001A
	Hose D15 with insulation 9 x 22 mm – 25 m (1)	WBCL002002A
	Hose D20 with insulation 9 x 28 mm – 25 m (1)	WBCL002003A
	Hose D25 with insulation 9 x 35 mm – 25 m (1)	WBCL001999A
	Hose D15 without insulation – 25 m (2)	WBCL002005A
	Hose D20 without insulation – 25 m (2)	WBCL002006A
	Hose D25 without insulation – 25 m (2)	WBCL002000A
	Tubular insulation for D12; 9 x 18 mm – 2 m (4)	WBCL002007
	Tubular insulation for D15; 9 x 22 mm – 2 m (4)	WBCL002008A
	Tubular insulation for D20; 9 x 28 mm – 2 m (4)	WBCL002009A
	Tubular insulation for D25; 9 x 35 mm – 2 m (4)	WBCL002829A
Adhesive foam, 50 mm wide – 15 m roll (5)	WBCL002010A	
T-piece 19-19-19 for hose D20 (3)	WBCL002011A	
T-piece 19-15-19 for reduction D20 – D15 (3)	WBCL002012A	
T-piece 15-15-15 for hose D15 (3)	WBCL002019A	

Pipe insulation closed, foam	d (mm)	D (mm)	Length (m)	pc. / box	for ABS:	Min. Order	Order number
 thickness: 13 mm	28	54	2	78	DN25	10	WBCL002830
	35	60	2	58	DN32	10	WBCL002831
	42	68	2	48	DN40	10	WBCL002832
	54	80	2	34	DN50	10	WBCL002833

Water system

	Sea water strainer	Order number	
	G 3/4" model 1160, height 105 mm, nickel-plated brass	WBCL010109A	
	G 1" model 1164, height 144 mm, nickel-plated bronze	WBCL010110A	
	G 1 1/4" model 1164, height 178 mm, nickel-plated bronze	WBCL010111A	
	G 1" model 1162, height 151 mm, nickel-plated bronze	WBCL010112A	
	G 1 1/4" model 1162, height 176 mm, nickel-plated bronze	WBCL010113A	
	Screen filter element for model 1160	WBCL010268A	
Sea-water strainer, 16 – 20 mm, with two nipples		Order number	
	Capacity in US gallons 350/1,000 US gallons/h Capacity in liters 25/50 l/min. Suitable for pump models WB250 – WB350/1000 H = 140 mm W = 100 mm D = diameter inlet/outlet 5/8" – 16 mm	WBCL001151A	
	D = diameter inlet/outlet 3/4" – 20 mm	WBCL001152A	
	Screen-filter element 1,000 Microns	WBCL001154	
	Sea-water strainer, 25 mm, with two nipples		Order number
		Capacity in US gallons 1,000 US gallons/h Capacity in liters 50 l/min. Suitable for pump models WB1000 to 2000 H = 290 mm W = 144 mm D = diameter inlet/outlet 1.25" – 32/40 mm 1" – 25 mm	WBCL001153A
Screen-filter element 1,000 Microns		WBCL001155	
Through-hull kits 16, 20, 25 mm		Order number	
		Capacity in US gallons 350 / 1,000 – 25 / 50 l / min. Suitable for pump models WB250 – WB350/1000 D = diameter inlet/outlet, 5/8" – 16 mm kit, 1/2" – 16 D = diameter inlet/outlet, 3/4" – 20 mm kit, 3/4" – 20	
		5/8" – 16 mm – 1 plastic valve (1 + 2 + 3)	WBCL001125A
	3/4" – 20 mm – 1 plastic valve (1 + 2 + 3)	WBCL001126C	
	5/8" – 16 mm + 2 x 90° plastic valve (1 + 3 + 5)	WBCL001123C	
	3/4" – 20 mm + 2 x 90° plastic valve (1 + 3 + 5)	WBCL001124A	
	Kit 5/8" – 16 mm – 1 nickel plated valve (1 + 4 + 2)	WBCL001175A	
	Kit 3/4" – 20 mm – 1 nickel plated valve (1 + 4 + 2)	WBCL001176A	
	Kit 5/8" – 16 mm – 2 nickel plated valves/bronze exit (1 + 4 + 5)	WBCL001177A	
	Kit 3/4" – 20 mm – 2 nickel plated valves/bronze exit (1 + 4 + 5)	WBCL001178A	
Kit 1" – 25 mm – 1 nickel plated valve/plastic exit (1 + 4 + 2)	WBCL001179A		

Water system

	Air bleeder t-piece for chilled water system	Order number
	Model 1000S (for pump WB1000): t-piece 3/4", diameter shut-off valve outlet 1/2" – 16 mm	WBCL001121A
	Model 2000S (for pumps WB1500-2500): t-piece 1", diameter shut-off valve outlet 3/4" – 20 mm	WBCL001122A
Chilled Water Circuit A/C Calorifiers		Order number
	With safety thermostat	
	Model 15 kW; 400 V; L = 1,015 mm; H = 200 mm; weight = 11 kg	WBCL002121
	Model 30 kW; 400 V; L = 1,590 mm; H = 200 mm; weight = 19 kg	WBCL002123
Air bleeder for seawater pumps		Order number
	Model 350R (for pumps WB250 and WB350): t-piece 3/4", diameter supply and outlet 1/2" – 16 mm	WBCL001118A
	Model 1000R (for pump WB1000): t-piece 3/4", diameter supply and outlet 3/4" – 20 mm	WBCL001119A
	Model 2000R (for pumps WB1500 – 2500): t-piece 1", diameter supply and outlet 3/4" – 20 mm	WBCL001120A

Webasto can provide all accessories for pressurized systems. Please contact us for further details.



Integrated solutions

Integrated solutions	136
BlueComfort Premium	138
Application concept	138
Application guidelines	139
Basic integration	140
DeLuxe integration	141

Integrated solutions



Webasto BlueComfort solutions combine an air-conditioning unit and a water heating unit into one integrated system. This allows yacht owners and sailors to expand the boating season as people can choose between heating and cooling at the push of a button.

Most air-conditioning systems have a reverse cycle function to enable heating with the A/C system. However, this requires mild sea water temperatures for efficient heating. Below 6°C sea water temperature the heat cycle becomes inefficient. To gain total autonomy from environmental conditions, an integrated water heater is the perfect solution.

BlueComfort Premium

- Integration of a chiller A/C unit and a diesel-operated water heater into one system
- Comfort like at home in any weather condition
- Modular concept allowing multiple configurations
- Full range of solutions for any size of boat

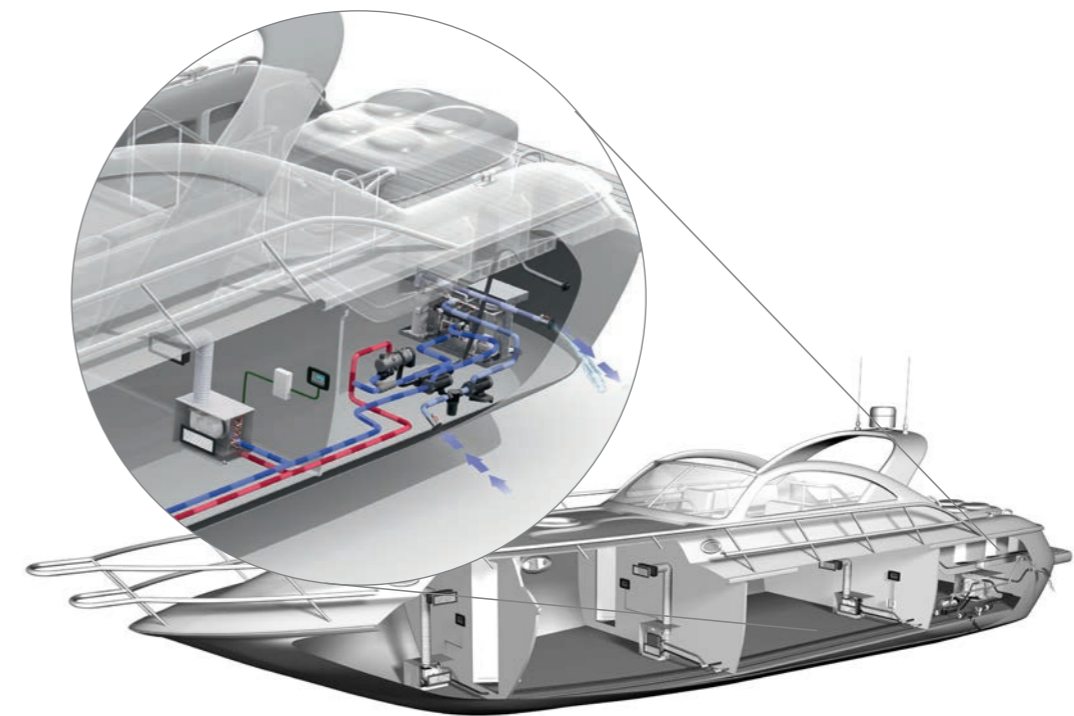

Best in class, when it comes to complete climate comfort: Chiller A/C unit and a powerful water heater.

BlueComfort Premium

Application concept

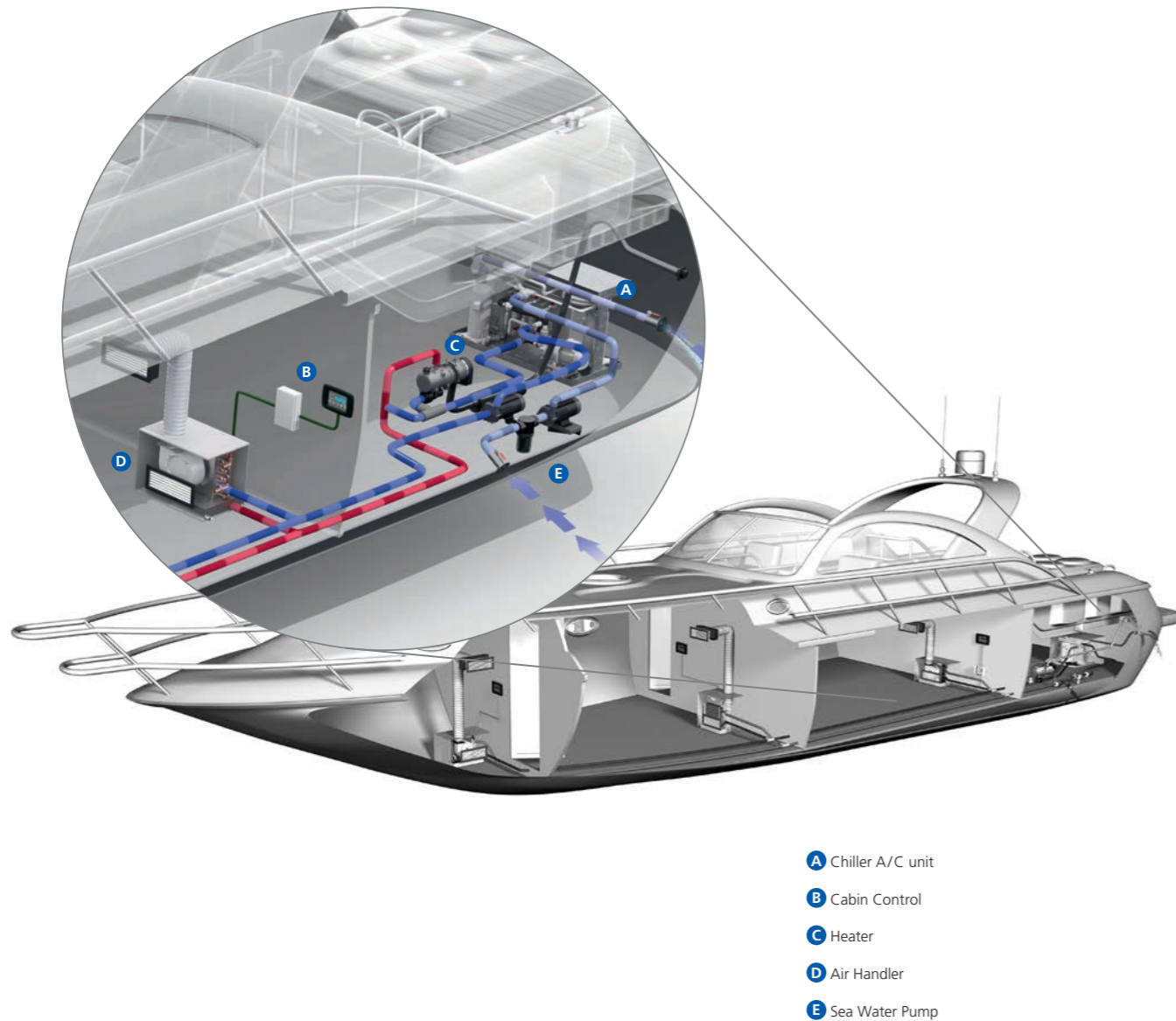

- A** Chiller A/C unit
- B** Cabin Control
- C** Heater
- D** Air Handler
- E** Sea Water Pump

BlueComfort Premium

Application guidelines

For a complete BlueComfort Premium system, please combine the following:

1. Chiller air-conditioner

Core unit

Please select the core unit according to the required cooling capacity, the available voltage and whether cool only or heating via reverse cycle is needed.

- Air-conditioning unit [SEE PAGE 88-105](#)

Position **A** as well as the following components are included in the scope of delivery:

- Electric cable and control box
- Operating manual
- Installation manual

Control elements for core unit

Please select the control elements for the core unit separately:

- MyTouch Display [SEE PAGE 118](#)
- Display cable [SEE PAGE 120](#)
- Remote air temperature sensor [SEE PAGE 120](#)

Sea water circuit

Please order separately the components for the sea water circuit consisting of:

- Sea water inlet [SEE PAGE 136](#)
- Sea water pump [SEE PAGE 122](#)
- Overboard discharge [SEE PAGE 136](#)
- Sea water strainer [SEE PAGE 136](#)
- Closing valve [SEE PAGE 134](#)
- Water hose [SEE PAGE 135](#)

Chilled water circuit

Please add the required components for the chilled water circuit consisting of:

- Circulation pump [SEE PAGE 122](#)
- 3-way valve (optional) [SEE PAGE 144](#)
- Turn ball valve [SEE PAGE 134](#)
- Piping or hosing system with insulation [SEE PAGE 128](#)
- Expansion tank [SEE PAGE 134](#)

Cabin accessories necessary for each single cabin

Please add for every single cabin the following components and accessories:

- Air handler [SEE PAGE 106](#)
- Supply air grille [SEE PAGE 127](#)
- Air ducting [SEE PAGE 129](#)
- Transition box [SEE PAGE 128](#)
- Water hoses for condensation drain [SEE PAGE 135](#)
- Cabin control (Air control, display cable, temperature sensor and control box) [SEE PAGE 120](#)
- Return air grille [SEE PAGE 127](#)

2. Water heater

Select the right heater according to the table below or more accurately as a results of the calculation in the specification tool.

Chiller air-conditioning cooling capacity							
BTU/h	12,000	24,000	32,000	40,000	48,000	60,000	
kW	3.5	7.0	9.3	11.7	14.0	17.6	
Heater	Thermo Pro 50		Thermo Pro 90			Thermo Pro 120	Thermo Pro 150

BlueComfort Premium

Basic integration

In a BlueComfort Premium system an A/C unit and a diesel-operated water heater are integrated into one system. The use of a water heater ensures full heating performance even at cooler sea water temperatures where the reverse cycle operation comes to its limits. In this integrated system the same water piping, air handlers, air ducting and cabin temperature control modules are used for both heating and A/C operation. For user friendliness, the main system is controlled via one control panel while each cabin has an individual temperature and blower speed control. The BlueComfort Premium system offers two integration options: the "Basic" and the "DeLuxe" integration depending on comfort requirements.

Basic integration

The Basic integration is simply **integrating a water heater with a 3-way valve into the chilled water system**. The valve ensures that no cold water is running through the heater which would cause condensation. Both, the heater and the 3-way motor valve are controlled by the A/C electronic control. A special heater with a lower temperature setting or additional thermostats are needed in order to limit the water temperature to 60°C.

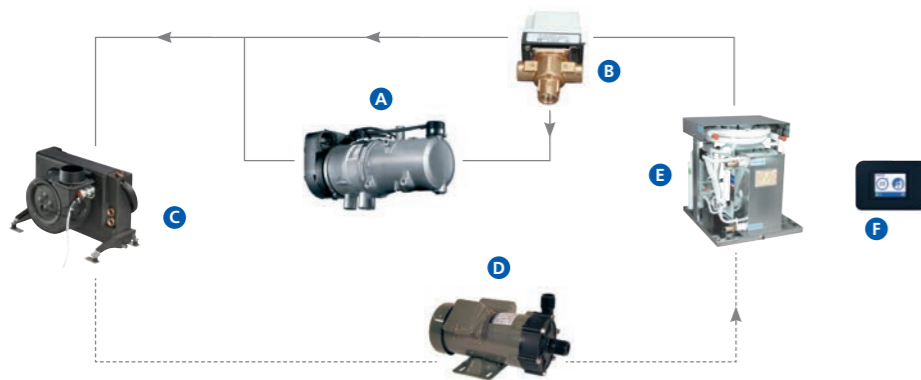

- A Water heater** Produces hot (60°C) water when system switches to heating
- B 3-way valve** Switches between cooling or heating loop
- C Air handler** Warms up or cools down returning air
- D Water pump** Circulates the water
- E A/C chiller unit** Cools down the water when system switches to cooling
- F Chiller control** Controls the complete A/C system and the water heater
Starts the compressor when cooling is necessary
Starts the heater when heating is necessary

BlueComfort Premium

DeLuxe integration

DeLuxe integration

The DeLuxe integration has all the features of the **Basic integration but additionally allows the integration of a water boiler as well as further fan blowers or radiators into the system.**

It therefore provides the highest comfort in heating and sanitary water supply. The mixing valve limits the water temperature in the A/C loop to 60°C. A summer/winter switch allows heating of the boiler in summer while the A/C system is cooling the cabins at the same time.

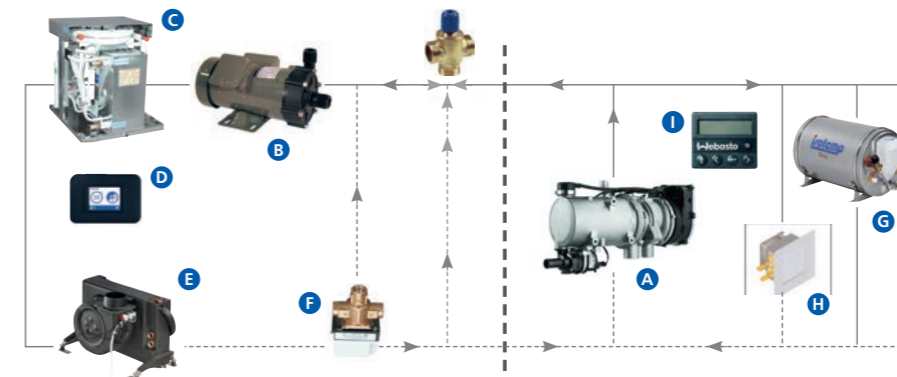

For a perfect integration Webasto recommends Isotemp double coil boilers. Visit www.indelwebastomarine.com

- A Water heater** Produces hot (approx. 80°C) water when system switches to heating
- B Water pump** Circulates the water
- C A/C chiller unit** Cools down the water when system switches to cooling
- D Chiller control** Controls the complete A/C system and the water heater
Starts the compressor when cooling is necessary
Starts the heater when heating is necessary
- E Air handler** Warms up or cools down returning air
- F 3-way valve** Switches between cooling or heating loop
- G Water boiler** Heats up the sanitary water
- H Blowers or radiators** can optionally be used in areas with extra high heating demand (e.g. windscreen for demisting)
- I Summer/Winter switch** Allows separate boiler operation in summer mode

BlueComfort accessories

For the chilled water system, the following key components are needed as well:

	Basic Integration	DeLuxe Integration
3-way motor valve	Thermo Pro 90 Chiller use 3/4" motor valve WBCL000776	Thermo Pro 90 chiller use 3/4" motor valve WBCL000776
	3-way motorized valve 1", 230 V, special for BlueComfort applications WBCL000777B	
Thermostatic mixing valve	Basic Integration	DeLuxe Integration
		Thermo Pro 90 use 3/4" mixing valve



Roof & Shading Solutions

Webasto marine roofs	144
Marine engineering and technical services	145
A roof solution for every boat	146
20-Series specifications	148
40-Series specifications	149
60-Series customization possibilities	150
80-/100-Series customization possibilities	151
New BlueSky Sliding Roof Range	153
The finishing touch – custom roof blinds	154
Hercules blind customization possibilities	155
New Marine Shading Solutions	165

Webasto marine roofs



Webasto offers a wide range of roof solutions, whether you are looking for a standard roof size with easy installation or a more customizable platform for your individual needs. As our customer you will additionally benefit from our technological leadership and knowledge brought over from our experience in the automotive sunroof industry.

Webasto standard and customizable solutions

Comfortable ready-to-go-platforms.

These are very economical solutions for more light and fresh air on board with a robust and proven construction. Our pre-mounted solution includes all necessary hardware allowing super quick and easy installation.

NEW: Extension of the BlueSky Range

Besides the electrical operated BlueSky, Webasto is now offering a manual version as well. The manual version is available in 2 sizes and offers the same quality and design features as the electrical operated version. The electrical operated version is now also available with a tempered glass panel and can be perfectly integrated in the design of the boat.

Webasto engineering services

Add value to your boats and your brand image by developing your own roof system with us.

We create unique, exclusive roof systems that match your exact specifications. Our phased project approach guarantees you limited risks, a possible exit at any stage and of course joint teams and know-how transfer. Take comfort in knowing that you are involved in every stage, and have the opportunity to use our engineering and manufacturing capabilities for high quality results.

Marine engineering and technical services

Webasto has 30 years' experience in advanced automotive roof systems which we apply to marine: kinematics, advanced materials, water management and sealing systems. We turn your ideas into reality and guarantee high quality and outstanding product know-how. Phased project approach and joint teams enable know-how transfer to your engineers.

Add value to your boat and brand image

- Unique, exclusive roof systems to match your exact specifications
- Phased project approach: limited risk, possible exit at any stage
- Joint teams and know-how transfer
- Customer involved at every stage
- Opportunity to use Webasto engineering skills and manufacturing capabilities for high quality results

The success of our projects is based on three fundamental elements

- **Product visualization:** Translate ideas into visual concepts. Phased project approach allows frequent evaluation and limits the customers' risk.
- **Product development:** Translate visual into technical concept. Joint teams require strong customer involvement (marketing, R & D, manufacturing).
- **Product validation:** Prepare drawing package for suppliers and assembly. Highly valuable know-how transfer ensures best outcome of the project investments at every stage.

Service

- We ensure a global network with over 50 locations throughout the world via our subsidiaries, representatives and authorized service network
- We guarantee an international warranty and customer support based on our commissionings
- We offer global trainings and technical guidelines
- We guarantee a fast availability of spare parts
- We are at your location with our dedicated marine service team

Quality

- We benefit from the high automotive standards and related advanced technologies
- We deliver personalized solutions for individual customer needs
- We provide fully tested, pre-assembled and ready-to-be-mounted solutions
- We supply added-value accessories
- Our solutions are highly engineered

Competence

- Our teams are made up of marine specialists and technical experts
- We can support our customers with any kind of commissioning
- Our innovations are the result of open communications and close partnership with our customers

A roof solution for every boat

Roof references

The 20-Series



A very economical manual or electrical sliding roof for more light and fresh air on board. The roof is fully tested and pre-assembled including all necessary hardware allowing quick and easy installation.

- Standard roof with large opening
- Watertight sealing
- Robust and proven construction
- Manual or electrical operation
- Stepless locking system

Economical and robust roof for more light on board

The 40-Series



This roof platform offers a sleek, low profile design to be able to fit in smaller boats. The roof is electrical operated, extremely quiet, and is delivered fully assembled, tested and ready to be installed.

- Attractive design with safety glass
- Watertight sealing
- Fast and simple installation
- Robust and quality-tested design
- Optional fixed glass panel for panoramic views

Standard electric marine sliding sunroof

The 60-Series



This series offers multiple customization options for a perfect fit. The roof is delivered fully tested, pre-assembled and ready-to-be-mounted at the shipyard thus resulting in significant cost saving for the boat builder.

- Customizable roof system
- Watertight sealing
- Robust and proven construction
- Electrical operation
- Smooth automotive style mechanism

The easy, ready-to-be mounted solution

The 80-Series



A completely dedicated roof solution whereby application engineering and a close cooperation with the shipyard is required. The roof is delivered fully tested, pre-assembled and ready-to-be-mounted.

- Fully integrated roof design
- Watertight sealing
- Very large dimensions and opening
- Selection of different panel materials
- Double curved solution is possible

Economical and robust roof for more light on board

The 100-Series



The 100 Series roof offers the same unique customization possibilities as the 80 Series. The mechanism is however upgraded to ensure perfect operation in combination with sliding panels up to 100 kg.

- Fully integrated roof design
- Watertight sealing
- Very large dimensions and opening
- Selection of different panel materials
- Double curved solution is possible

Roof design for extra large glass and composite panels

The BlueSky



The BlueSky sunroofs are designed for smaller boats and are now available in a number of variants. A choice can be made in terms of operation, dimension and panel type. The robust manual mechanism features a ventilation position and can be locked in any slide position.

- 2 sizes
- Electrical or manual operation
- Modern acrylic panel or flush glass panel
- High end interior finish
- Watertight sealing
- Robust and proven construction

Innovative light weight sliding roof

20-Series specifications

One size fits all

Select options

- Sunblind / flyscreen
- Also electrical version available

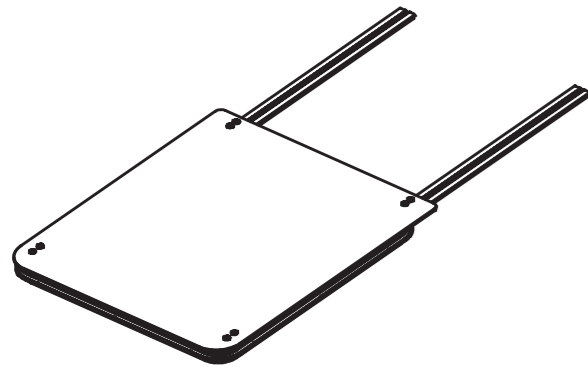

Technical specifications

	20-Series
Frame material	Aluminum
Panel material	8 mm tempered safety glass/grey tinted
Sliding rail material	Aluminum
Overall dimensions (mm)	1,995 x 1,010
Cut-out length (L1) (mm)	1,010
Cut-out width (W1) (mm)	955
Corner radius (FRC, RCR) (mm)	80
Operation mode	Manual, stepless locking
Opening dimension (mm)	800 x 800
Weight (kg)	approx. 40

Technical specifications are subject to change without prior notice.

40-Series specifications

A perfect fit

Select options

- Fixed panel
- Sunblind/flyscreen
- Motor cover

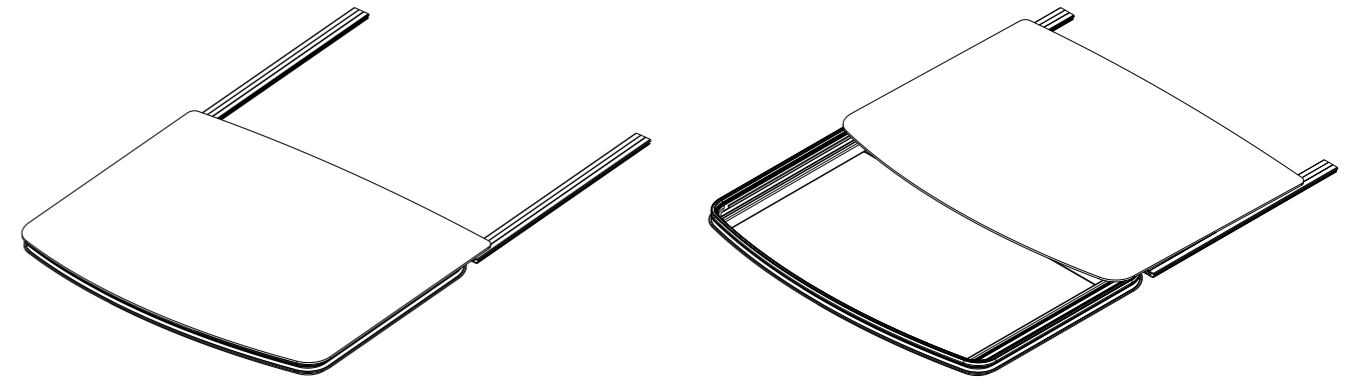

Technical specifications

	40-Series
Frame material	Aluminum
Panel material	8 mm tempered safety glass/grey tinted
Sliding rail material	Aluminum
Overall dimensions	1,665 x 1,379 mm (1,865 x 1,379 with fixed panel)
Cut-out length (L1) (mm)	915
Cut-out width (W1) (mm)	1,320
Corner radius (FRC, RCR) (mm)	80
Cross radius (R2) (mm)	7,620
Front radius (R3) (mm)	2,032
Operation mode	Electrical 12 V DC
Opening dimension (mm)	624 x 1,172
Weight (kg)	approx. 45

Technical specifications are subject to change without prior notice.

60-Series customization possibilities

5 steps to customize your roof

- 1** Select roof type:
 - Top mount
 - Flush integrated
- 2** Define dimensions:
 - Length
 - Width
 - Curvature
- 3** Select panel design:
 - Acrylic
 - Glass
 - Sandwich
- 4** Select frame finish:
 - Anodizing
 - Powder coating
- 5** Select options:
 - Motor cover
 - Fixed panel
 - Sunblind/flyscreen
 - 24 V DC (12 V DC is standard)

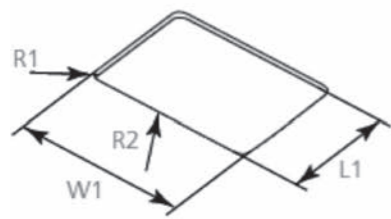
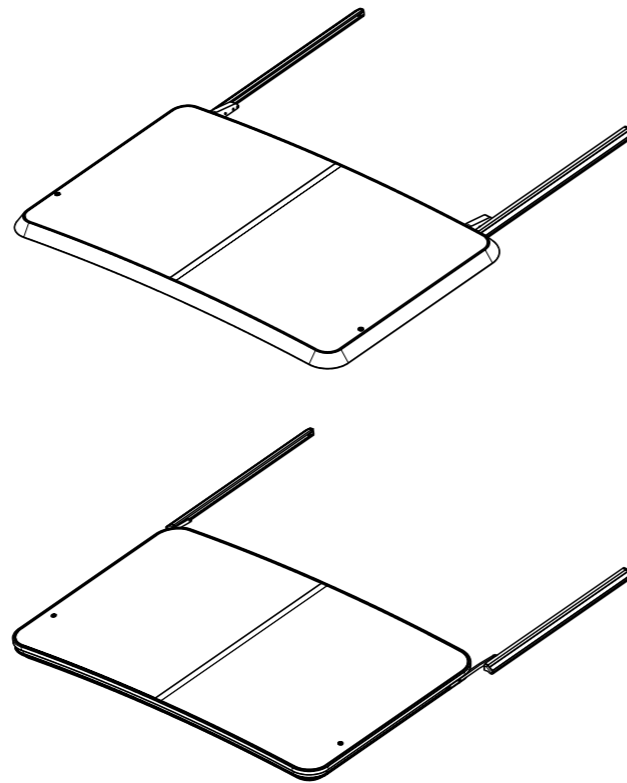

Figure 1

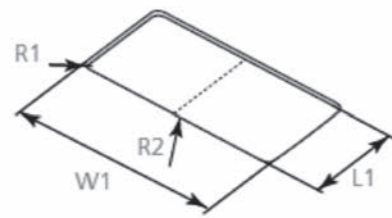

Figure 2

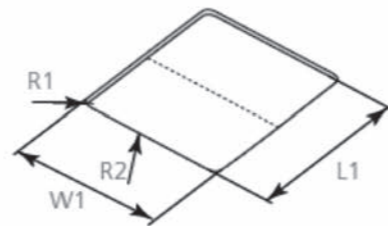

Figure 3

Technical specifications

Maximum cut-out size dimensions for our customized roofs		Max. length L1 (mm)	Max. width W1 (mm)	Corner curvature R1 (mm)	Min. cross curvature R2 (mm)
Figure 1	Roof without cross beam	1,100	1,100	80	7,500
Figure 2	Roof with cross beam in sliding direction	1,100	1,800	80	7,500
Figure 3	Roof with cross beam perpendicular to sliding direction	1,500	1,100	80	7,500

80-/100-Series customization possibilities

5 steps to customize your roof

- 1** Select panel design:
 - Glass
 - GRP
 - Sandwich
- 2** Select roof shape:
 - Square
 - D-shape
- 3** Define dimensions:
 - Length
 - Width
 - Curvatures
- 4** Select design:
 - Glass color
 - Frame color
- 5** Select options:
 - Fixed panel
 - Sunblind/flyscreen
 - 24 V DC (12 V DC is standard)

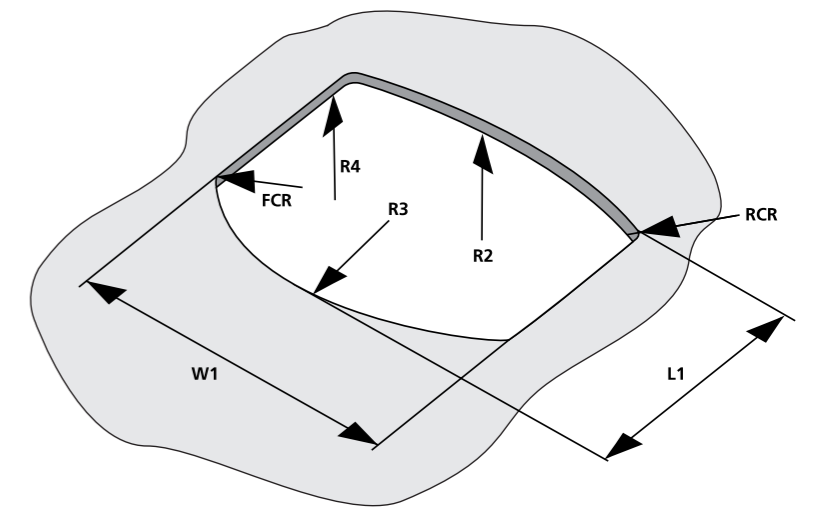

Technical specifications

Dimension code	Description	Glass	GRP	Sandwich
W1	Maximum width	2,750	2,750	2,750
L1	Maximum length	1,900	2,400	1,900
R2	Minimum cross radius	7,500	7,500	7,500
R3	Minimum front radius	2,500	2,500	2,500
R4	Minimum length radius	N.A.	5,000	N.A.
FCR	Front corner radius	Mitred or R = 80	Mitred or R = 80	Mitred or R = 80
RCR	Rear corner radius	Mitred or R = 80	Mitred or R = 80	Mitred or R = 80

Remark: All dimensions are in mm
 Maximum dimension of glass and GRP panel is defined by maximum weight of 80/100 kg
 Glass panel and Sandwich panel only have a cross radius (single bended)
 Glass panel and Sandwich panel have fixed radius of: 7,500; 10,000; 15,000; 30,000 mm



BlueSky Unique Sliding Hatch

The BlueSky sunroofs are designed for smaller boats and are now available in several variants. A choice can be made in terms of operation, dimension and panel type.

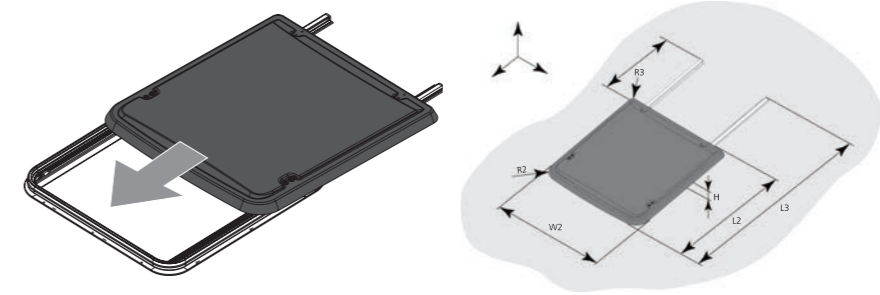

Electric operation

Thanks to the electrical operation the hatch is easy to use and the panel can be blocked in any desired position. The tilting and sliding mechanism in combination with the seal ensures full water tightness.

Manual operation

Besides of the electrical operated BlueSky also a manual version is available. The manual version offers the same quality and design features as the electrical operated version. This version is a good alternative in those cases where a more economical solution is desired.

Acrylic panel

The acrylic panel is made from two acrylic shells with a screen print resulting in a modern design, light weight and improved insulation. This construction is unique in the marine industry.

Glass panel

Besides of the acrylic panel the electrical operated BlueSky can also be offered with a 6 mm grey tinted glass panel. This variant is the top end of the range and offers a flush integration in the boat design.

Cut-out size

Besides of the cut-out dimension 770 x 720 the BlueSky roof is now also available in a smaller size, 500 x 500. This variant is available in combination with manual operation and acrylic panel only. The styling of the product is similar to the 770 x 720 variant.

Black finish

Following the market trend, the BlueSky roofs are available in all black finish. This creates a more modern look and is in line with the black window pillars and frames.

Technical specifications

Description	BlueSky Range			
	Electric L770 W720 Glass	Electric L770 W720 Acrylic	Manual L770 W720 Acrylic	Manual L500 W500 Acrylic
Frame Material	Aluminium	Aluminium	Aluminium	Aluminium
Panel Material	6 mm Glass	2x3 mm Acrylic / Grey Tinted	2x3 mm Acrylic / Grey Tinted	2x3 mm Acrylic / Grey Tinted
Sliding rail material	Aluminium	Aluminium	Aluminium	Aluminium
Overall Dimensions (L3 x W2) (mm)	1.462 x 777	1.490 x 810	1.490 x 810	944 x 590
Cut-out Length (L1) (mm)	770	770	770	500
Cut-out Width (W1)	720	720	720	500
Corner radius (FRC, RCR) (mm)	65	65	65	65
Operation Mode	Electrical 12 VDC	Electrical 12 VDC	Manual	Manual
Opening Dimension (L x W) (mm)	508 x 642	483 x 642	456 x 684	192 x 464
Weight (kg)	approx. 19	approx. 14	approx. 11	approx. 8
Partnumbers	3398857A - Black Finish	3398857A - Black Finish	3398817A - Black Finish	3398818A - Black Finish

The finishing touch – custom roof blinds

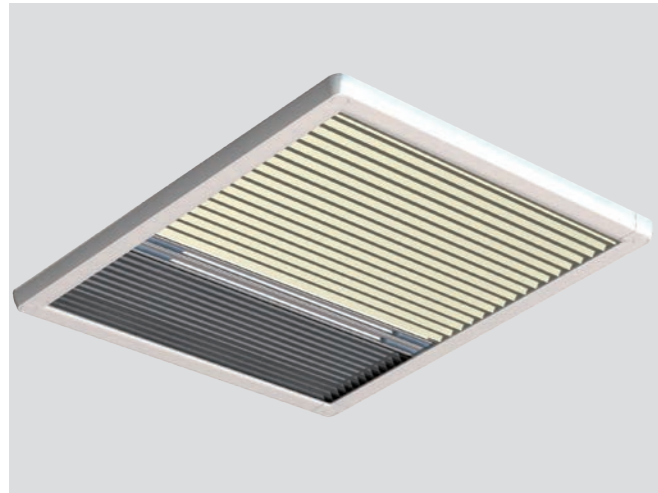

Sky screen pleated for 20-Series/Blue Sky

- Perfect fit: Dedicated dimension for 20-Series and available in 2 colours.
- Integrated flyscreen: Allows for cabin ventilation whilst keeping the insects out.
- UV protection: Essential overhead shading from direct sunlight, providing energy efficient light and temperature control.
- Quick and easy to install: Pre-assembled, surface mount, robust aluminium frame with concealed mounting holes.

Hercules blind

- Robust: Use of intermediate bars leaves for a cordless and safe open aperture.
- Large dimensions: Designed to complement Webasto's wide range of roof systems.
- Integrated flyscreen: Allows for cabin ventilation whilst keeping the insects out.
- UV protection: Essential overhead shading from direct sunlight, providing energy efficient light and temperature control.
- Fully customizable: System is offered in various configuration possibilities and colours.
- Quick and easy to install: Full frame system, pre-assembled before installation.

Hercules blind customization possibilities

Three steps to customize your blind

- 1 Select frame design:
 - Blind & flyscreen – Double ended
 - Blind & flyscreen – Single ended
 - Blind only – Single ended
 - Flyscreen only – Single ended
- 2 Select fabric colour:
 - White
 - Ivory
 - Straw
 - Beige
- 3 Define dimensions:
 - Drop (max. 2,800 mm)
 - Width (max. 2,400 mm)
 - Curvature (min. 7,500 mm)

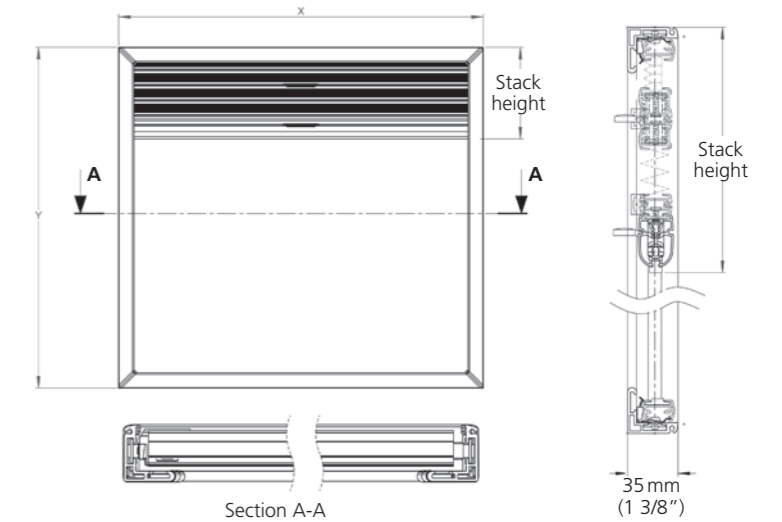

New Marine Shading Solutions

Perfect shelter for sunny days on the water

NEW



Benefiting from over 10 years of experience in marine roof systems, Webasto is offering their newly developed Marine Shading Solutions Range. With the Folding Shade & Rolling Shade System, Webasto provides the perfect shelter for sunny days on the water.

The systems are designed for the use above the cockpit, rear deck or fly bridge and can be operated with the touch of a button. Thanks to the smart and straight forward designs the products are easy to customize ensuring a perfect match with the styling of the boat.



Technical Highlights:

- For application above cockpit, rear deck or fly bridge
- Smart & customizable design to perfectly match the style of the boat
- Easy to use, operation of the system by the touch of a button
- Folding Shade 2500: sliding and folding
- Rolling Shade 2500: sliding and rolling
- Based on automotive kinematics and drive systems
- Tension & locking system for tensioning the fabric
- Self-adjusting cross beam fixation to cope with installation tolerances

New Marine Shading Solutions

Technical details

General	Folding Shade 2500	Rolling Shade 2500
Description		
Operation	Electric with Rocker switch	Electric with Rocker switch
Operation voltage	12 VDC	12 VDC
Installation method	Rails, cross beam & fabric are screwed and mounted from the top. Drive system screwed from the bottom.	Complete system is mounted from the top
Materials used	Rails and cross beams are aluminium, anodized. Sliders are plastic and stainless steel	Rails and cross beams are aluminium, anodized. Sliders are plastic and stainless steel
Fabric material outside	Sunbrella, type: Plus, different colors possible	Sunbrella, type: Plus, different colors possible
Fabric material inside	Dickson, type: Velum, different colors possible	N.A.
Allowable temperature (°C)	-10 to +75	-10 to +75
Dimensions		
L1 Length (mm)	Maximum outside dimension is: 2,750	Maximum outside dimension is: 2,000
W1 Width (mm)	Maximum outside dimension is: 2,500	Maximum outside dimension is: 2,500
Longitudinal curvature (mm)	Minimal 10,000	Straight
Cross curvature (mm)	Minimal 10,000	Minimal 10,000
Remark	Curvature combination between longitudinal and cross direction to be evaluated per application	



Folding Shade 2500



Nomenclature

In order to define descriptive technical abbreviations for our air-conditioner and our air handler units, Webasto introduced a special nomenclature for the price list.

Air-conditioning units nomenclature

Air-conditioning model abbreviations:

C = Chiller (BlueCool C-Series)

Example: C55T-R-230V-REV-R410A = Chiller 55,000 Twin Rotary compressor 230 V reversible refrigerant R410A						
C	55	T	-R	-230 V	-REV	-R410A
C-Series	55,000 BTU/h	Twin	Rotary comp	Voltage	REV = reverse cycle	refrigerant

S = Self-Contained (BlueCool S-Series)

Example: S6-R-230V-REV-R410a = Self-Contained 6,000 230 V reversible						
S	6	-R	-230 V	-REV	-R410A	
Selfcontained	6,000 BTU/h	Rotary compressor	Voltage	REV = reverse cycle	refrigerant	

P = Professional Chiller (BlueCool P-Series)

Example: P60M-S-400V-REV-R407C = P-Series Chiller 60,000 Mono Scroll 400 V reversible refrigerant R407C						
P	60	M	-S	-400 V	-REV	-R407C
P-Series	60,000 BTU/h	Mono	S = Scroll comp.	Voltage	REV = reverse cycle COOL = Cool only	refrigerant

A = Air handler (BlueCool A-Series)

Example: A12 Compact -230V -50/60Hz = A-Series Air handler Compact type 12,000 kBTU/h 230 V; 50 Hz and 60 Hz						
A	12	Compact	-230 V	-50/60 Hz		
A-Series	12,000 BTU/h	Compact type	Voltage	Frequency		

