

WeatherTech®

CupFone Duo

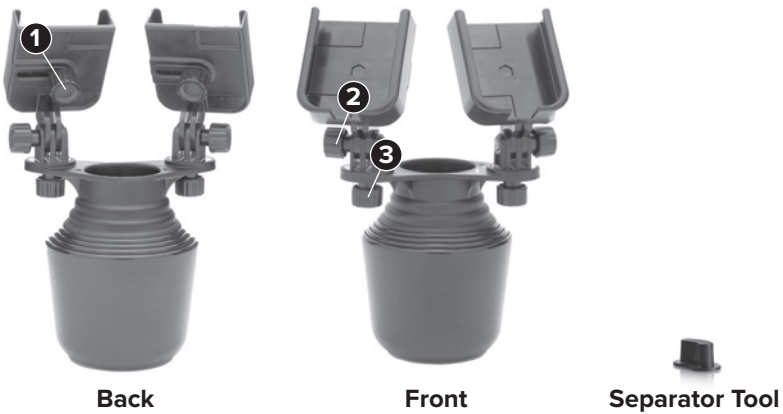

Fitting Into Your Cup Holder

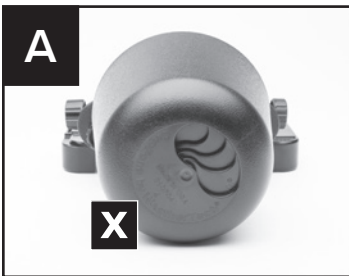

CupFone Duo comes with multiple base cups to perfectly fit your cup holder. Ensure only one opening on the bottom is visible at a time.

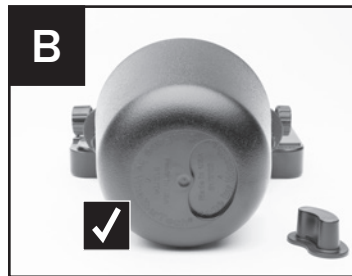

To separate your base cups, align the **separator tool** with the hole on the bottom of each cup.

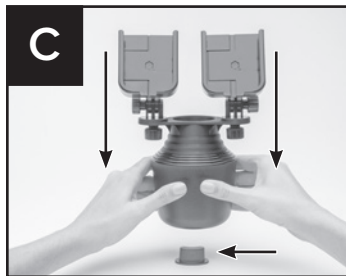

Push down on the tool to pop each cup out until you find the right fit.



Insert CupFone Duo into your cup holder and swivel both heads until you and your passenger find your ideal view.

Adjusting the Settings

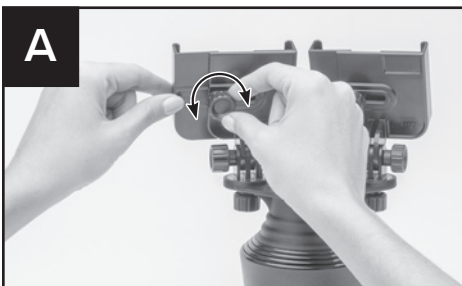

Adjust the width of each CupFone Head with **knob 1**.

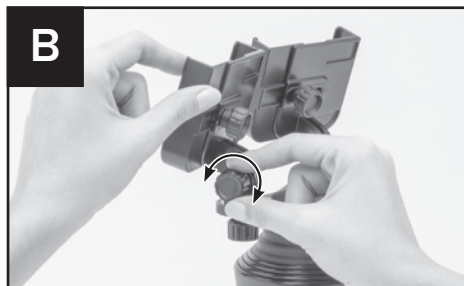

Adjust the tilt with **knob 2**.

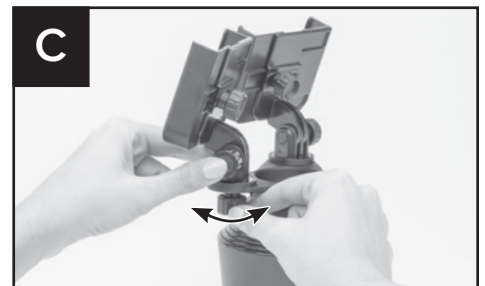

Adjust the swivel and rotation with **knob 3**.

These instructions also work for the CupFone Duo XL, made specifically for extra large phones.



67CFD1 © 2021 MacNeil IP LLC