

# WeatherTech®

## Easy-On™ Stone & Bug Deflectors

### Important Safety Information



- CAUTION - Before driving, ensure that the hood shield is properly secured to vehicle.
- Do not use automatic "brush-style" car washes.
- Do not use cleaning solvents of any kind.
- Periodically check all components for tightness.

### Contents **NOTE:** Actual product may vary from illustration.



Hood Shield

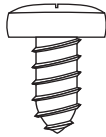

Phillips Screw x4

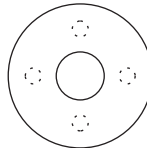

Plastic Washer x4



Alcohol Pad x2



Bump On x4

### Tools Required



Car Wash Supplies



Clean Towel

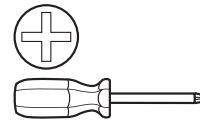

Phillips Screwdriver

### Preparation Before Painting / Installation

- A trial fit is recommended to ensure proper positioning and fit.
- Check fit of parts before painting as we will not accept the return of modified or painted parts.
- Wash and dry your vehicle to remove any debris and/or dirt from the installation area.

### Installation Steps **NOTE:** Actual application may vary slightly from illustrations.

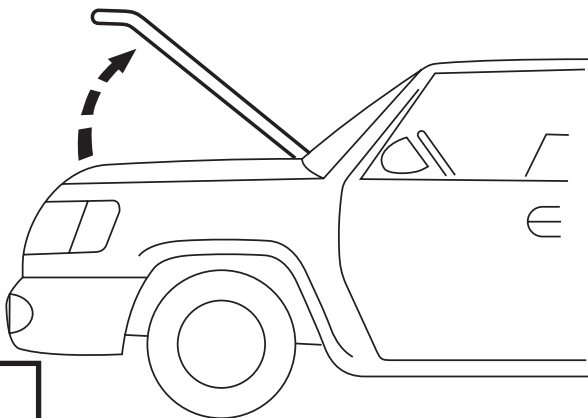

1

Center hood shield on hood. Note locations of (4) holes in hood shield and the corresponding locations on hood.

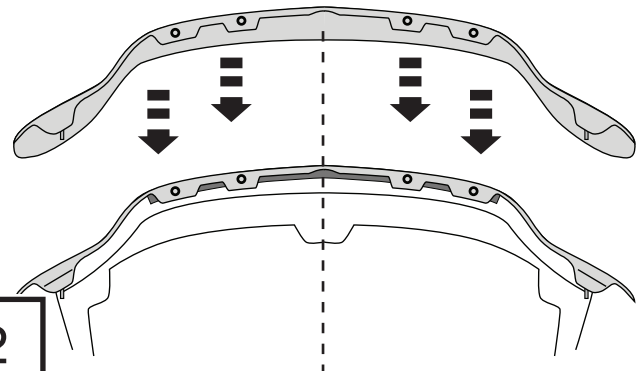

2

# Installation Steps

**NOTE:** Actual application may vary slightly from drawings.

Remove and discard (4) fasteners from hood weatherstrip noted in **Step 2**.

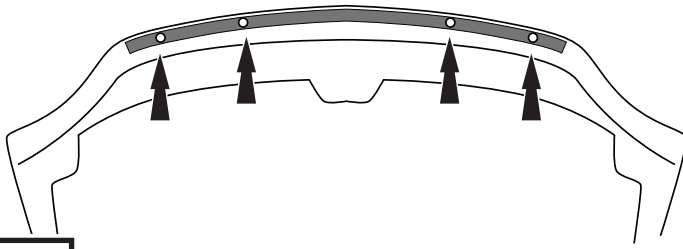

3

Clean **outboard** edges of hood with an alcohol pad.

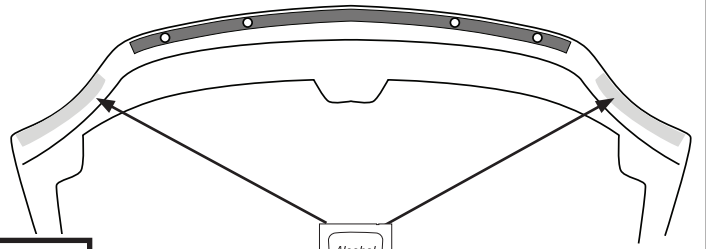

4

Peel back 2" (5cm) of tape liner from each end of hood shield.

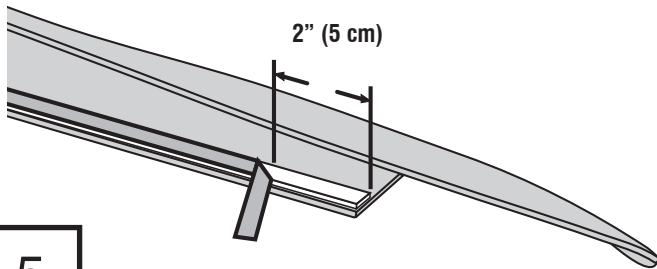

5

Carefully slide (4) **inboard** hood shield flanges **under** weatherstrip and align hood shield with holes in hood.

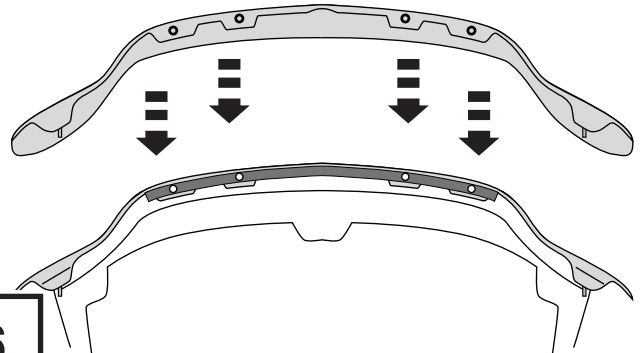

6

Install (4) phillips screws with washers as indicated.

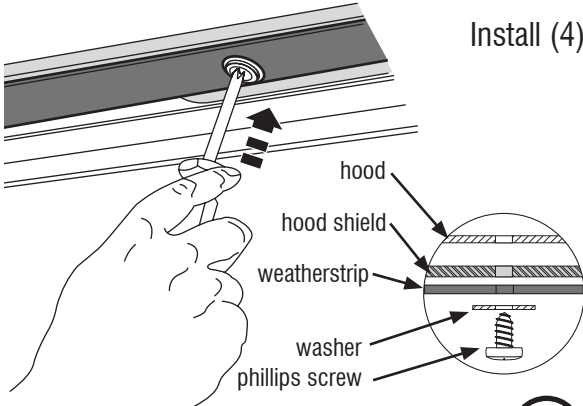
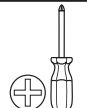
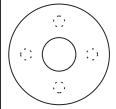
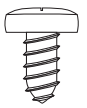

Do not overtighten

(X4)

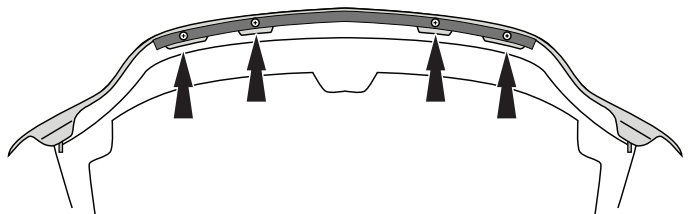

7

Remove tape liner from both **outboard** flanges.

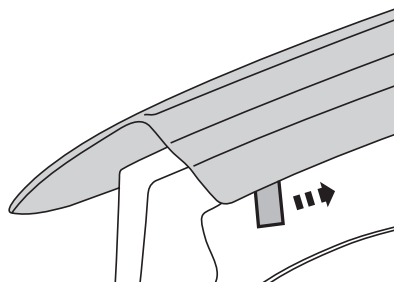

8

(X2)

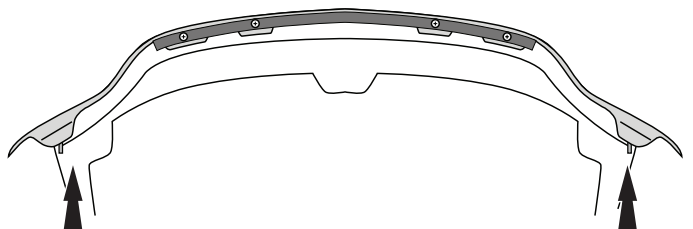

## Installation Steps

**NOTE:** Actual application may vary slightly from drawings.



Apply pressure to flanges to ensure adhesion to hood surface.

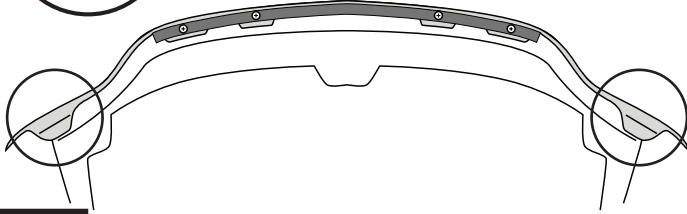

9

Close hood.

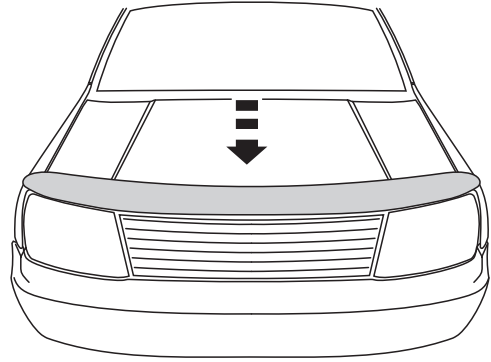

10



Apply bump ons at precleaned locations on hood surface.

X4

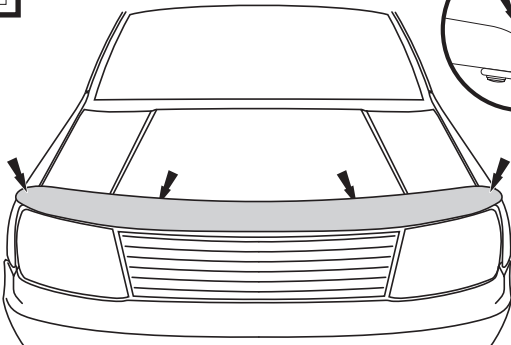

11

## Care and Cleaning

- Wash only with mild soap & dry with a clean cloth.