

WeatherTech®

Easy-On™ Stone & Bug Deflectors

Important Safety Information



- CAUTION - Before driving, ensure that the hood shield is properly secured to vehicle.
- Do not use automatic "brush-style" car washes.
- Do not use cleaning solvents of any kind.
- Periodically check all components for tightness.

Contents

NOTE: Actual product may vary from illustration.



Hood shield



Fastener x2

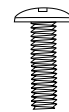

Machine Screw x2



Washer x2



Well Nut x2



Bump On x4



Alcohol Pad

Tools Required



Car Wash Supplies



Clean Towel



Phillips screwdriver

Preparation Before Painting / Installation

- A trial fit is recommended to ensure proper positioning and fit.
- Check fit of parts before painting as we will not accept the return of modified or painted parts.
- Wash and dry your vehicle to remove any debris and/or dirt from the installation area.

Installation Steps

NOTE: Actual application may vary slightly from illustrations.

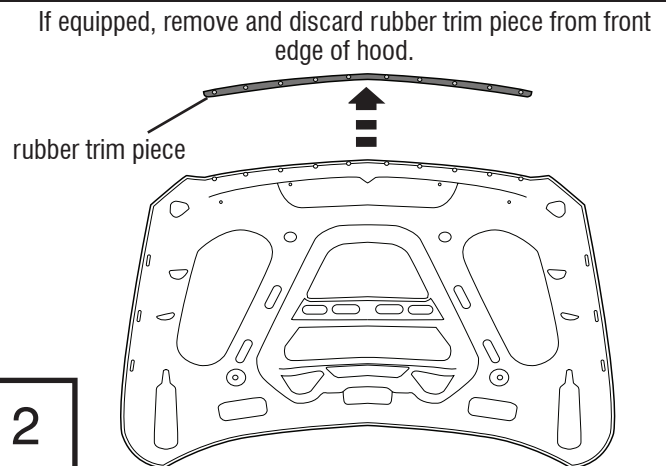
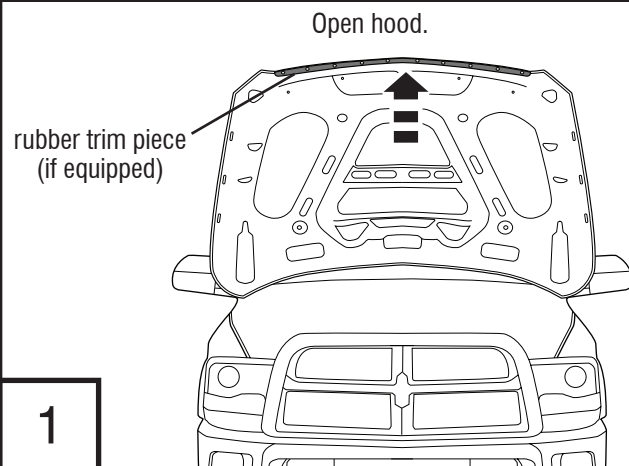

Installation Steps

NOTE: Actual application may vary slightly from illustrations.

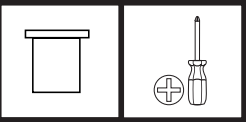

Install (2) wellnuts on hood shield flanges using (2) machine screws and (2) washers. Tighten finger tight only at this point.

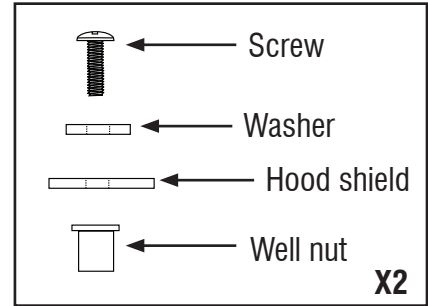
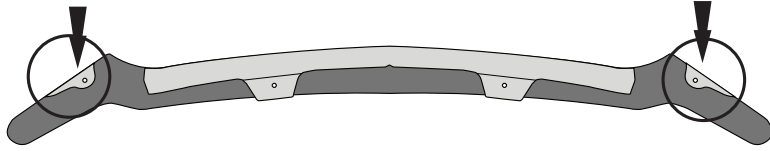
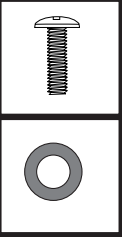

3

Align holes in hood shield with holes in hood in order to center part in place.

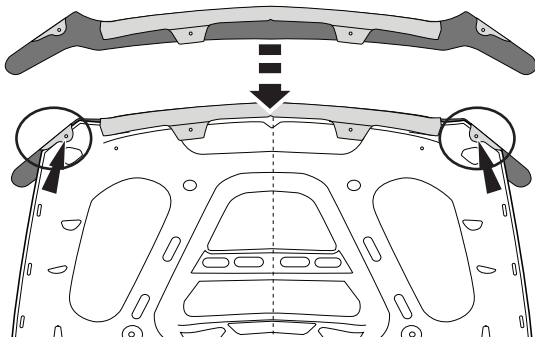

4

NOTE: observe the alignment from the side view in order to guide the hood shield with its attached well nut into the proper hole in the hood.

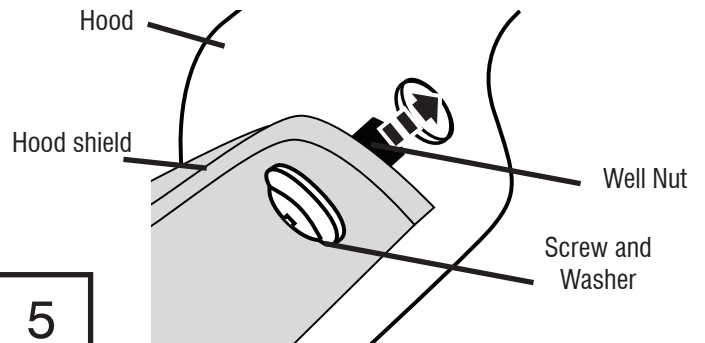

5



With the well nut inserted into hole in hood, secure hood shield to hood by tightening screw to expand well nut. Repeat for remaining fastener.

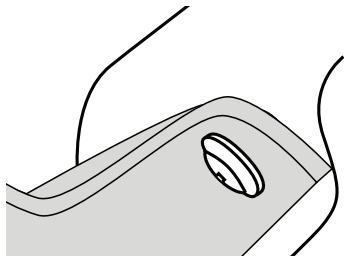

DO NOT OVER TIGHTEN

6

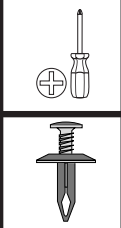

Insert (2) fasteners through the hood shield and into the hood and securely tighten.

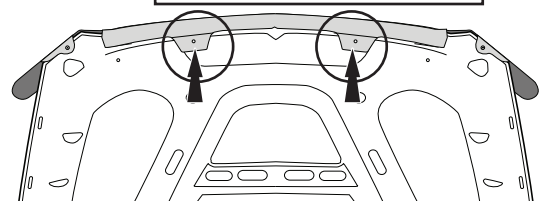
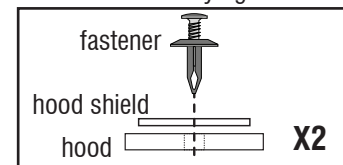

DO NOT OVER TIGHTEN

7



Close hood. Clean four (4) locations on the painted hood surface with an alcohol pad. Apply four (4) bump ons as indicated.

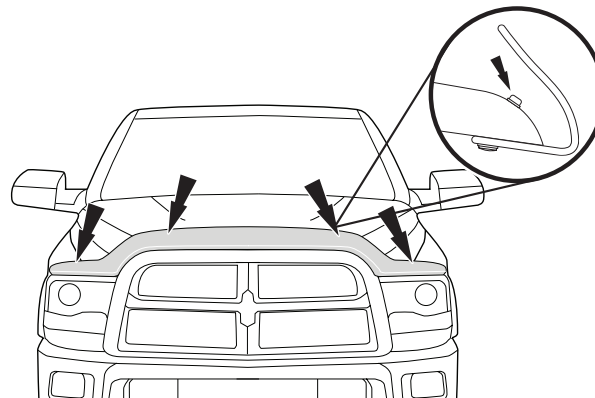

8

Care and Cleaning

- Wash only with mild soap & dry with a clean cloth.