

WeatherTech®

Easy-On™ Stone & Bug Deflectors

Important Safety Information

- ⚠️ **CAUTION** - Before driving, ensure that the hood shield is properly anchored to vehicle.
- Do not use automatic "brush-style" car washes.
- Do not use cleaning solvents of any kind.
- Periodically check all components for tightness.

Contents **NOTE:** Actual product may vary from illustration.

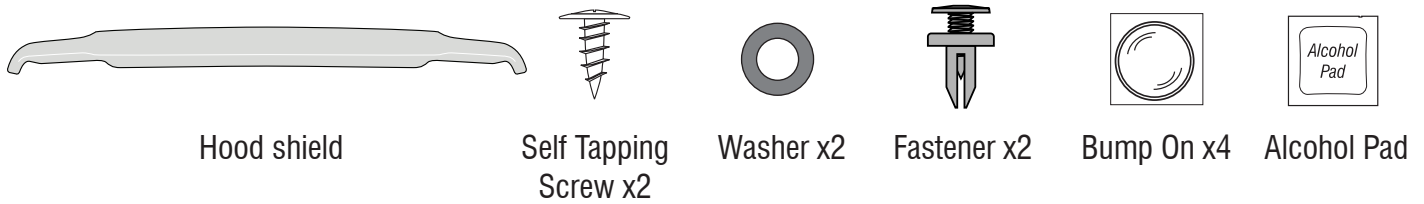

Tools Required

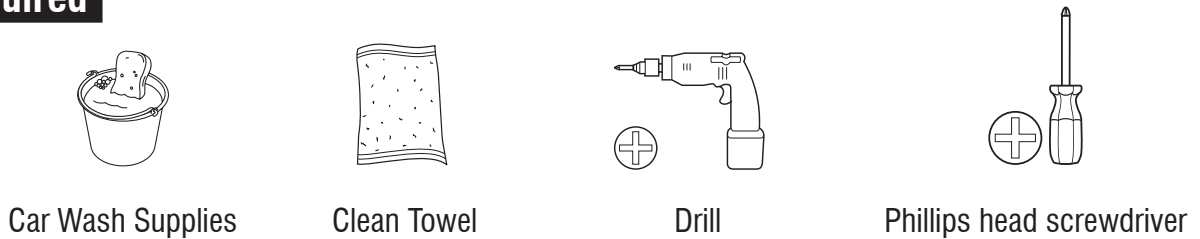

Preparation Before Painting / Installation

- A trial fit is recommended to ensure proper positioning and fit.
- Check fit of parts before painting as we will not accept the return of modified or painted parts.
- Wash your vehicle's hood to remove any debris and/or dirt.
- Dry the hood with a clean towel.

Installation Steps **NOTE:** Actual application may vary slightly from illustrations.

1

Open Hood. Clean indicated areas with an alcohol pad.

2

Expose 2" (5 cm) of tape liner from each end of the flanges on the hood shield.

Installation Steps

NOTE: Actual application may vary slightly from illustrations.

Center part on front edge of hood and align holes.

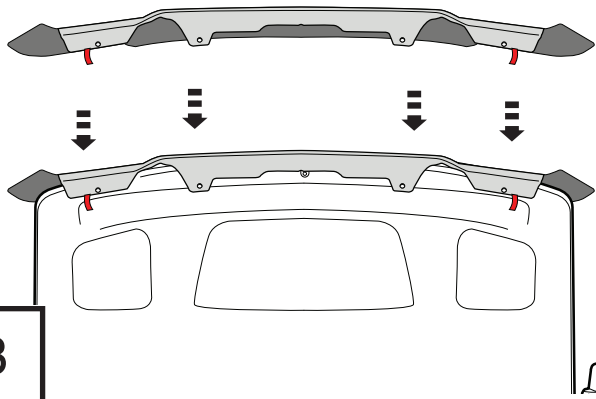

3



Install (2) fasteners in the INBOARD holes.

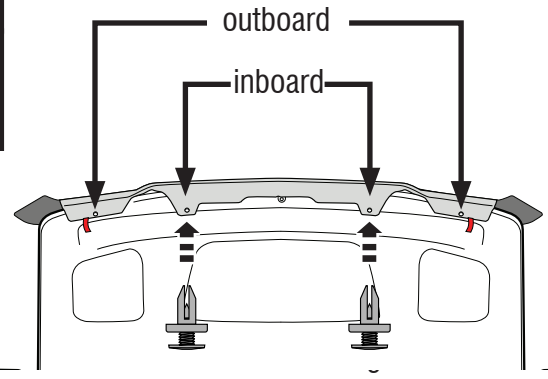

4

Remove remaining tape liner by pulling on exposed ends. Apply pressure to outboard flanges to ensure tape adhesion.

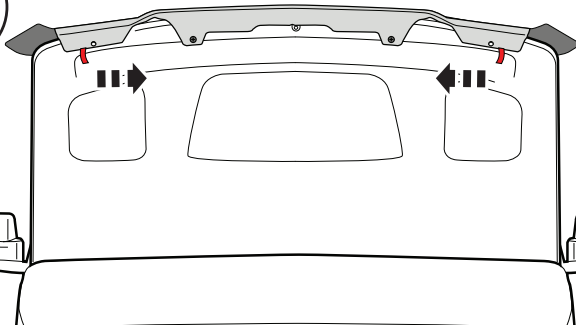

5

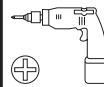

6

Install (2) self tapping screws through the OUTBOARD holes on hood shield.

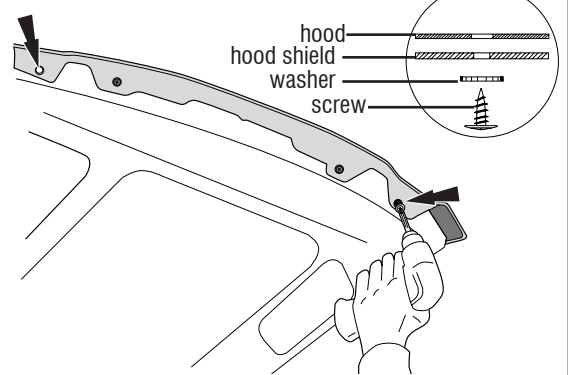

Close Hood.

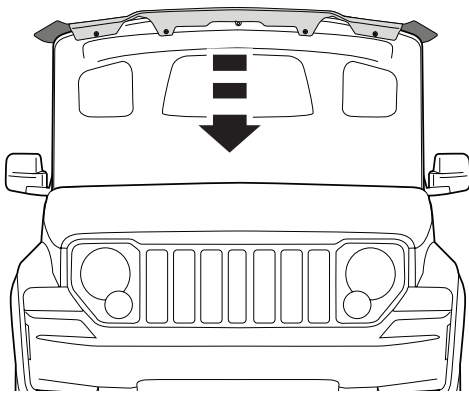

7



Apply bump ons to surface of hood.

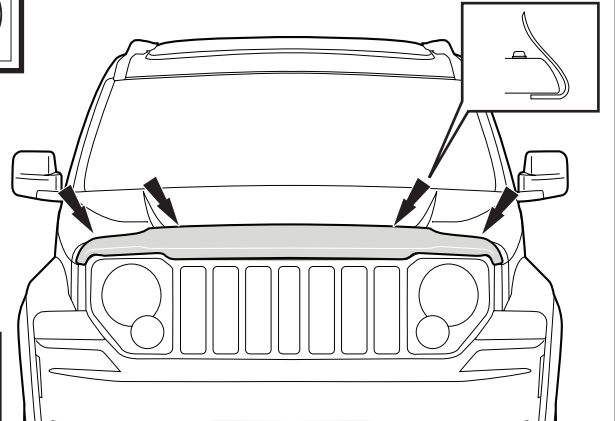

8

Care and Cleaning

- Wash only with mild soap & dry with a clean cloth.