

WeatherTech®

Easy-On™ Stone & Bug Deflectors

Important Safety Information



- CAUTION - Before driving, ensure that the hood shield is properly anchored to vehicle.
- Do not use automatic "brush-style" car washes.
- Do not use cleaning solvents of any kind.
- Periodically check all components for tightness.

Contents **NOTE:** Actual product may vary from illustration.



Hood shield



Fastener x2



Pin x5
(2008 Sequoia and
2010 Tundra ONLY)



Bump On x4

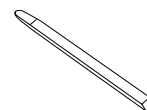

Pry Tool x1
(Tundra ONLY)

Tools Required



Car Wash Supplies



Clean Towel

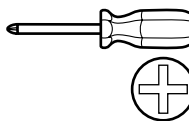

Phillips screw-
driver

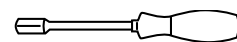

10mm Nut
Driver

Preparation Before Painting / Installation

- A trial fit is recommended to ensure proper positioning and fit.
- Check fit of parts before painting as we will not accept the return of modified or painted parts.
- Wash and dry your vehicle to remove any debris and/or dirt from the installation area.

Installation Steps **NOTE:** Actual application may vary slightly from illustrations.

NOTE: Steps 1 - 3 2007-2009 Tundra ONLY

Locate the plastic applique on the grill.

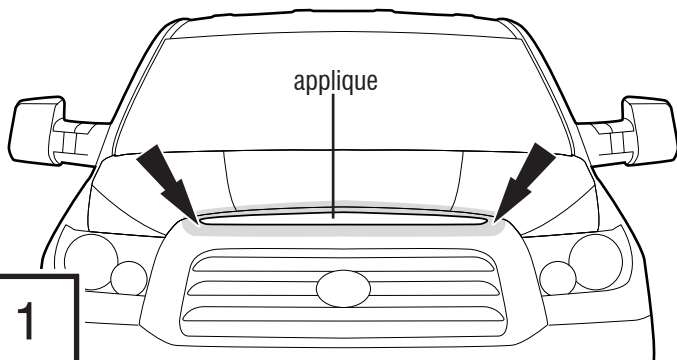

1



Using the Pry Tool provided, carefully pry the plastic applique away from the grill. Begin by lifting up the bottom drivers side corner and work your way across to the bottom passenger side corner. Remove applique.

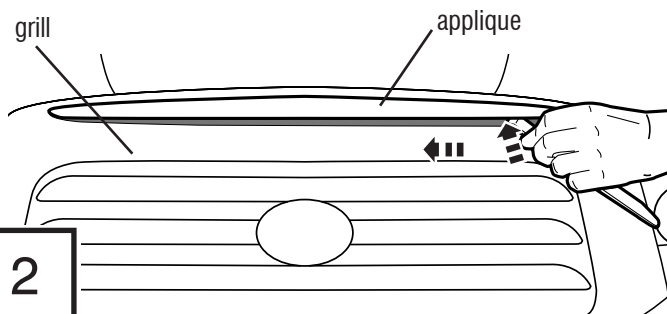

2

Installation Steps

NOTE: Actual application may vary slightly from illustrations.



With the applique removed, use a 10mm nut driver to remove the (5) exposed bolts.

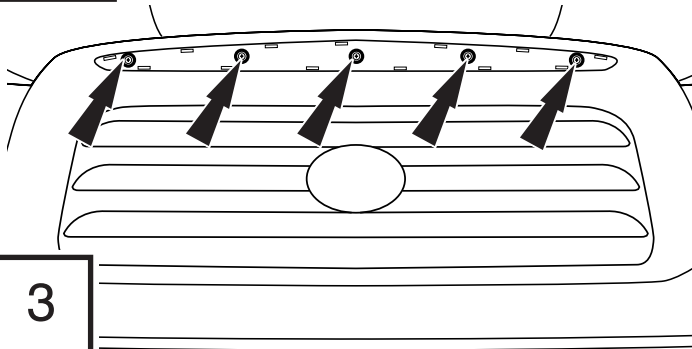

3

Carefully raise hood.

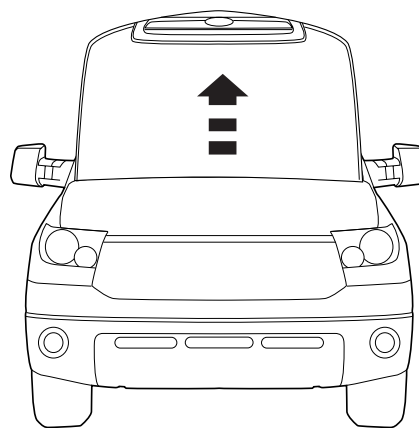

4

Reach under the hood to the backside of the grill and disconnect the hood lock rod from the grill by releasing the lock mechanism and gently lifting the rod away from grill.

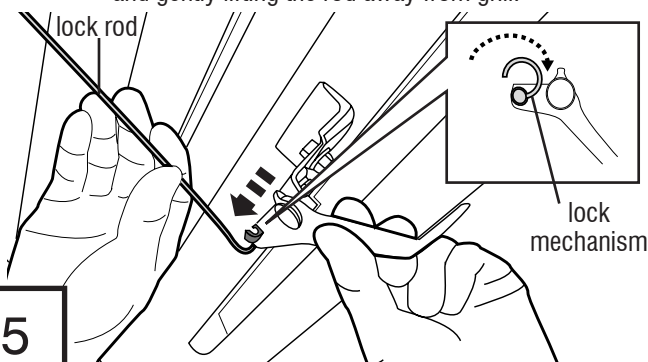

5



Reach under the hood to the backside of the grill, and using a nut driver remove (10) nuts.

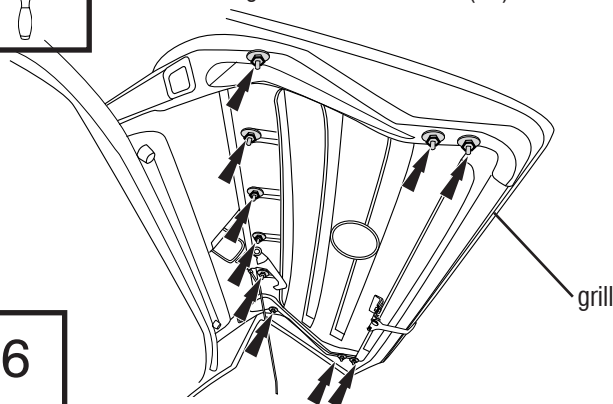

6

Carefully lower hood.

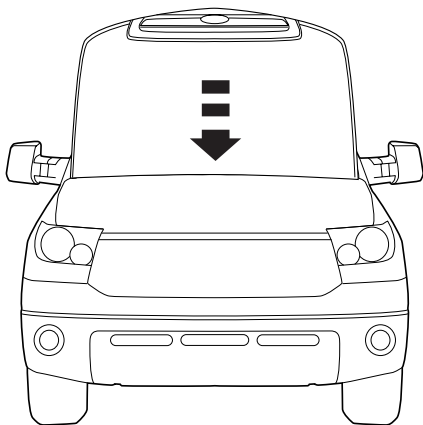

7

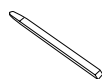

Starting on the driver side top corner of the grill, and then the passenger side, use the Pry Tool provided to carefully pry the grill loose from the hood. Set grill aside.

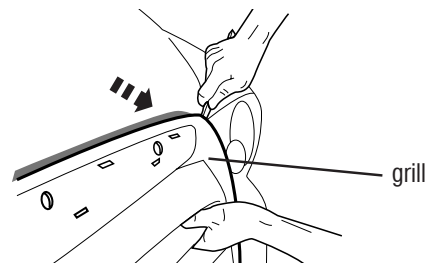

8

NOTE: The grill will make a "popping" noise as it separates from the vehicle. This is normal.



Clean front of hood edge, and carefully raise hood.

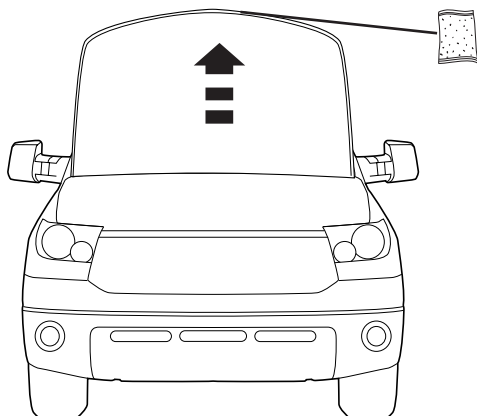

9

Align hood shield with hood edge.

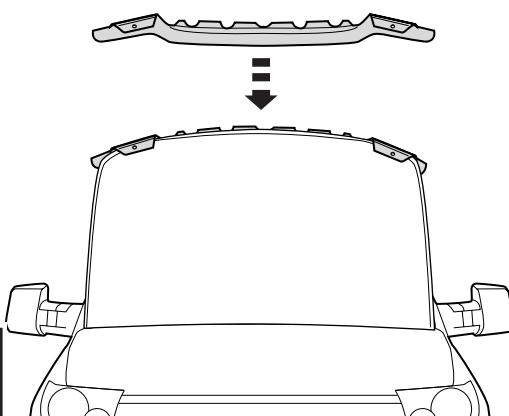

10

Installation Steps

NOTE: Actual application may vary slightly from illustrations.

11

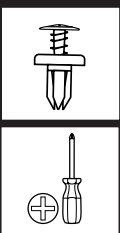

Align (2) holes in hood shield with holes in hood.
Install a fastener in each hole.

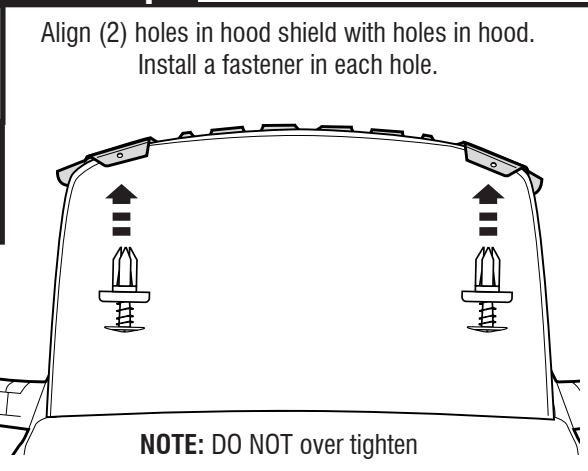

NOTE: DO NOT over tighten

12

Carefully lower hood.

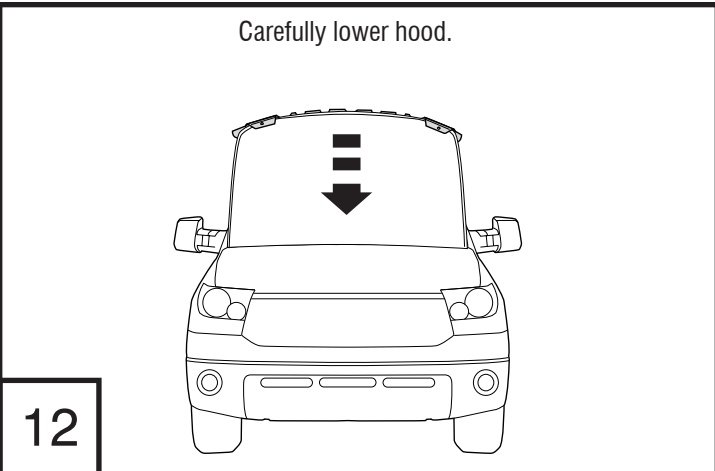

13

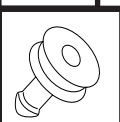

NOTE: 2008 - up Sequoia and 2010 - up Tundra ONLY

Replace (5) existing white pins on backside of grill with longer pins included in kit.

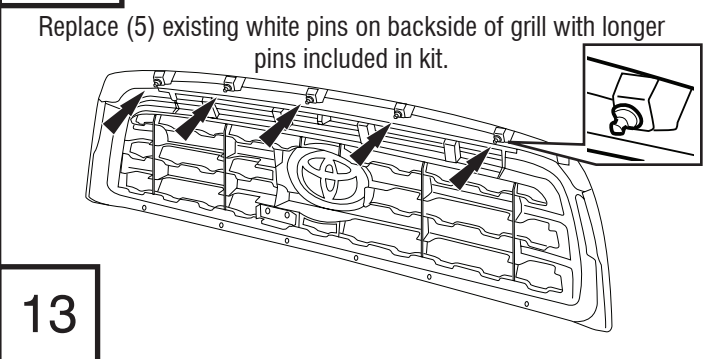

14

Reinstall grill by aligning with holes in hood edge. Ensure that the hood shield is **BETWEEN** the grill and the hood.

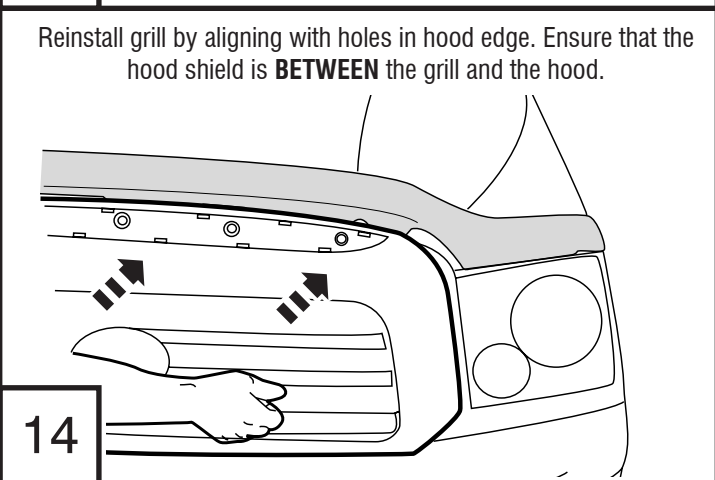

15

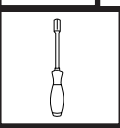

NOTE: 2007-2009 Tundra ONLY

Reattach the grill by reinstalling (5) bolts previously removed.

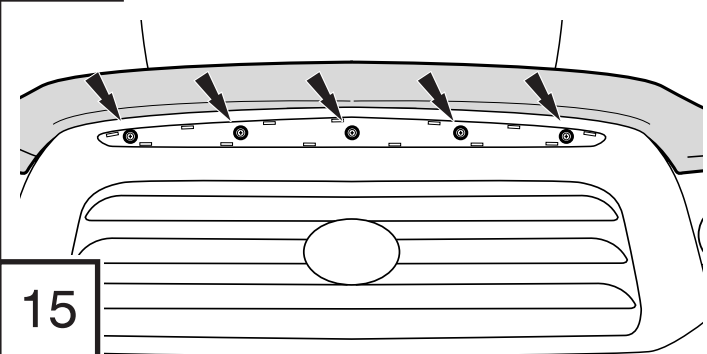

16

Carefully raise hood.

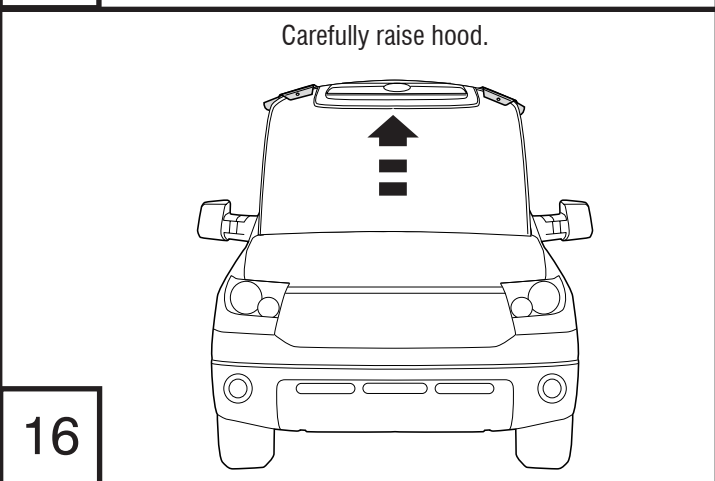

17

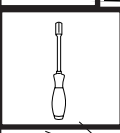

Reach under the hood to the backside of the grill, and reinstall (10) nuts previously removed.

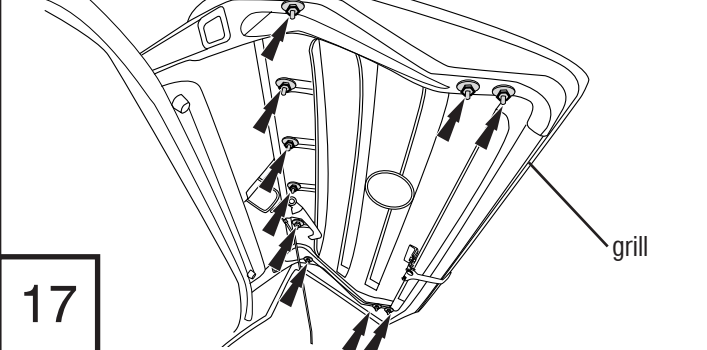

grill

18

Reach under the hood to the backside of the grill and reattach the hood lock rod to the grill.

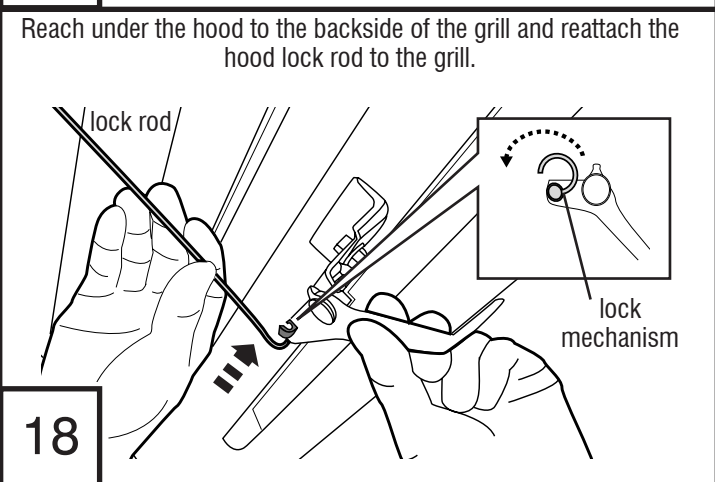

lock rod

lock mechanism

Installation Steps

NOTE: Actual application may vary slightly from illustrations.

Carefully close hood.

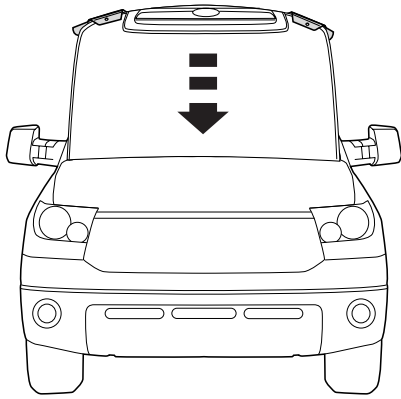

19

NOTE: 2007-2009 Tundra ONLY

Carefully reinstall the previously removed applique. Slide the top clips in first, then press firmly to snap remaining tabs into place.

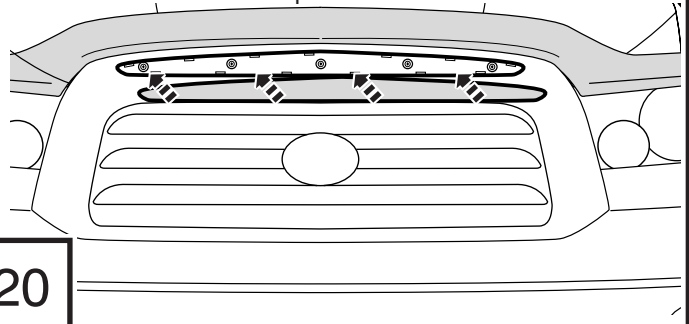

20



Apply (4) Bump ons to hood surface.

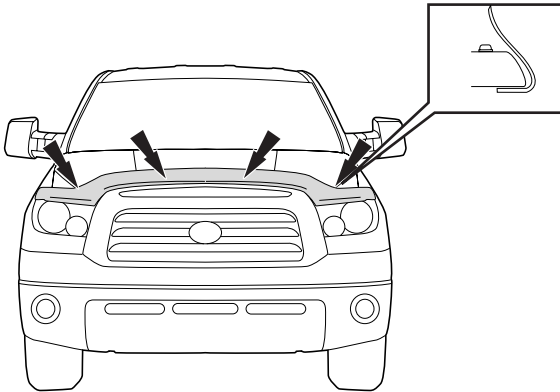

21

Care and Cleaning

- Wash only with mild soap & dry with a clean cloth.