

WeatherTech®

Easy-On™ Stone & Bug Deflectors

Important Safety Information



- CAUTION - Before driving, ensure that the hood shield is properly anchored to vehicle.
- Do not use automatic “brush-style” car washes.
- Do not use cleaning solvents of any kind.
- Periodically check all components for tightness.

Contents **NOTE:** Actual product may vary from illustration.



Hood shield



Screw x4
(98027)



Washer x4
(98026)



Insert x4
(98025)



Fastener x2
(98030)



Bump On x4
(98024)

Tools Required



Car Wash Supplies



Clean Towel

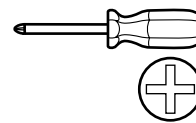

Phillips screw-
driver

Preparation Before Painting / Installation

- A trial fit is recommended to ensure proper positioning and fit.
- Check fit of parts before painting as we will not accept the return of modified or painted parts.
- Wash and dry your vehicle to remove any debris and/or dirt from the installation area.

Installation Steps **NOTE:** Actual application may vary slightly from illustrations.

Raise hood.

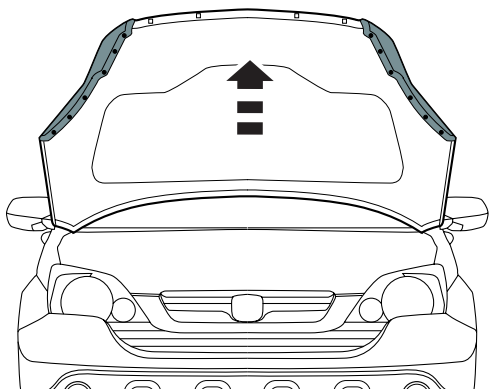

1



Locate (4) square holes on the underside of hood. Clean the area around these with a soft cloth. Install (1) insert in each square hole

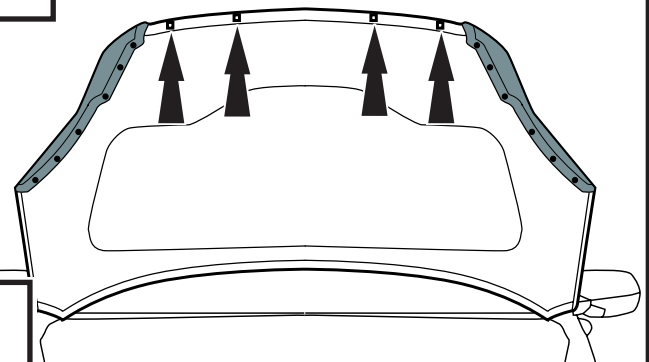

2

Installation Steps

NOTE: Actual application may vary slightly from illustrations.

Locate (2) rubber trim pieces on the underside of hood. On each side, locate and remove the retainer that is located second from the front.

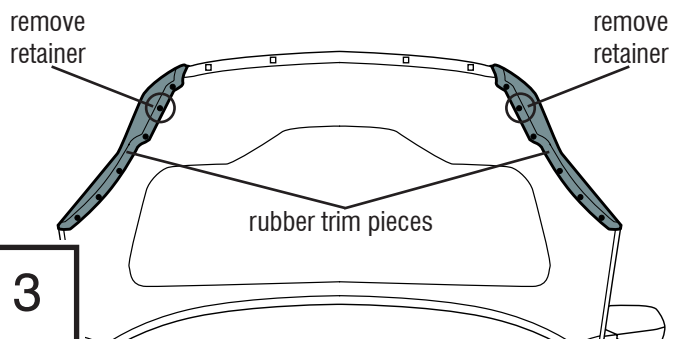

Center part on front edge of hood and align holes. Slide the outboard flanges **UNDER** the rubber trim pieces.

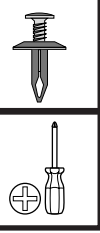
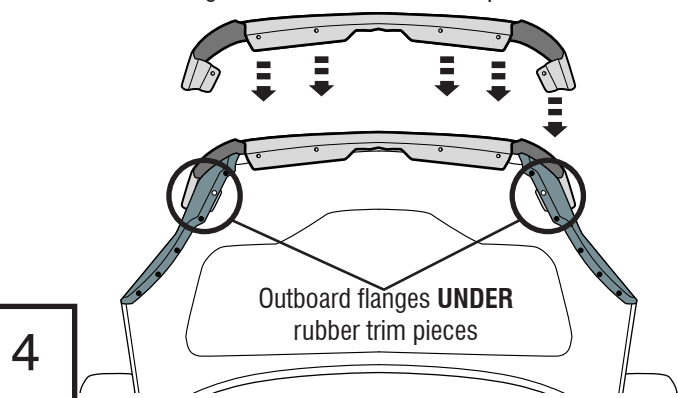

Insert a fastener through rubber trim piece and hood shield, and into hood on each **OUTBOARD** flange. Tighten fastener.

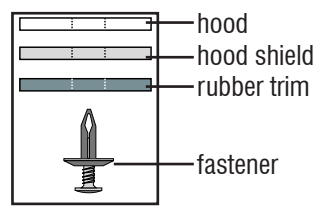
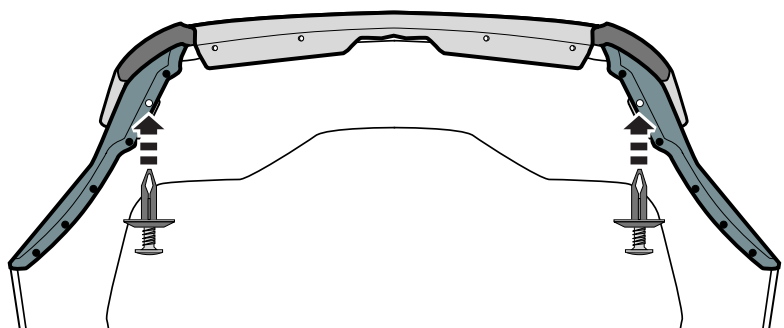

5

NOTE: DO NOT OVER TIGHTEN

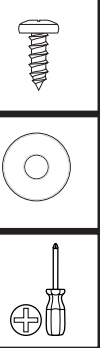

Place a washer over a screw and insert through hood shield and into hood. Repeat for remaining holes. Tighten screws.

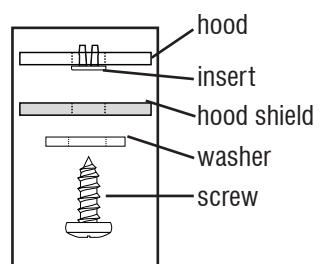
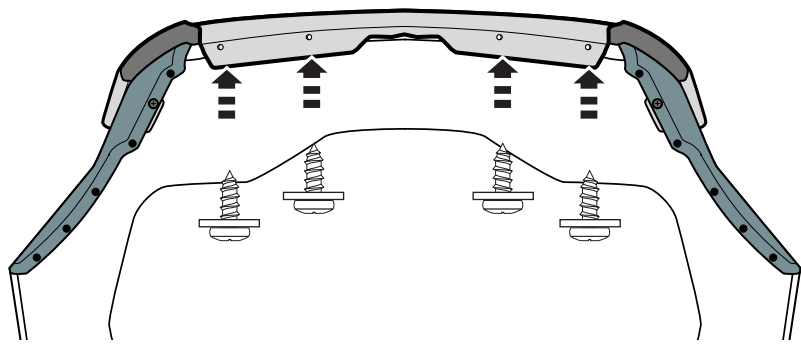

6

NOTE: DO NOT OVER TIGHTEN

Close Hood.

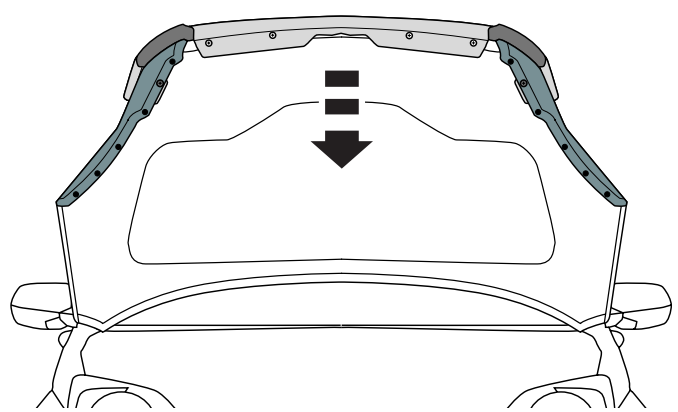

7

Installation Steps

NOTE: Actual application may vary slightly from illustrations.



Apply bump ons to surface of hood.

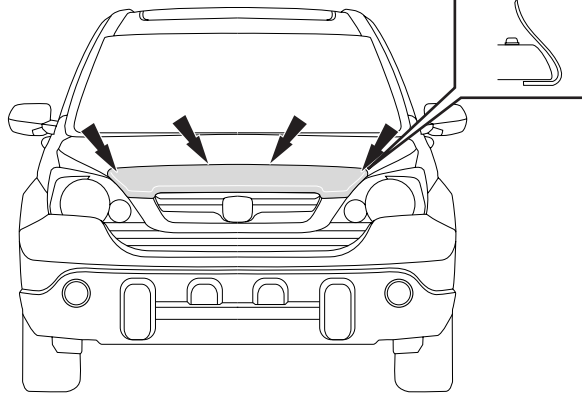

8

Care and Cleaning

- Wash only with mild soap & dry with a clean cloth.