

WeatherTech®

Easy-On™ Stone & Bug Deflectors

Important Safety Information



- CAUTION - Before driving, ensure that the hood shield is properly secured to vehicle.
- Do not use automatic "brush-style" car washes.
- Do not use cleaning solvents of any kind.
- Periodically check all components for tightness.

Contents

NOTE: Actual product may vary from illustration.



Hood shield



Bump On
x4



Fastener
x4

Tools Required



Car Wash Supplies

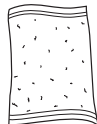

Clean Towel



Phillips
screwdriver

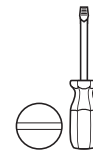

Flathead
screwdriver

Preparation Before Painting / Installation

- A trial fit is recommended to ensure proper positioning and fit.
- Check fit of parts before painting as we will not accept the return of modified or painted parts.
- Wash and dry your vehicle to remove any debris and/or dirt from the installation area.

Installation Steps

NOTE: Actual application may vary slightly from illustrations.

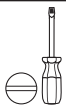

Open hood. Locate (4) fasteners that attach the rubber seal to the underside of the hood, and correspond with predrilled holes in hood shield. Remove and discard.

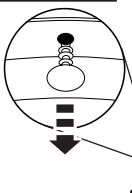

1

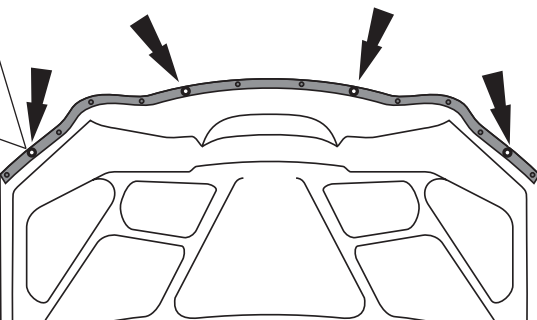

Position the hood shield with the tabs sliding **between** the hood and rubber seal. Align holes.

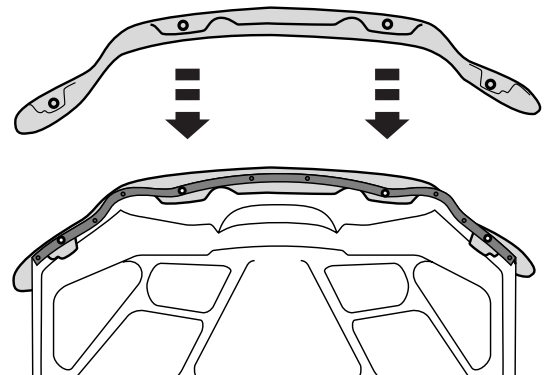

2

Installation Steps

NOTE: Actual application may vary slightly from illustrations.

Insert (1) fastener and screw until snug. Repeat for remaining (3) fasteners.

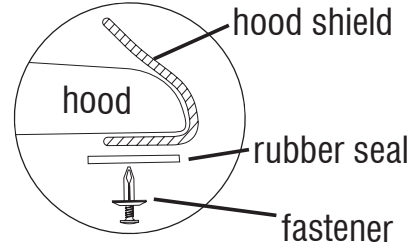
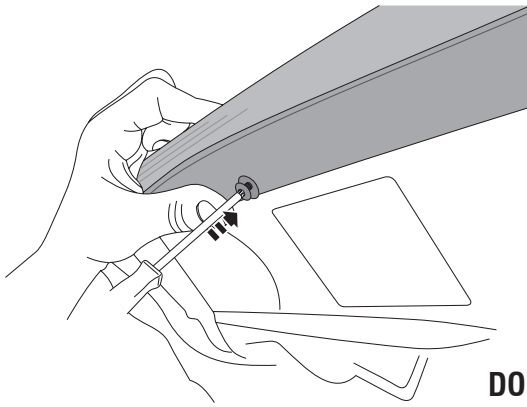

3

DO NOT OVER TIGHTEN



Install bump ons at pre-cleaned locations on the painted hood/fender surface.

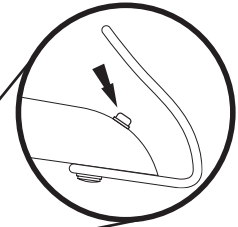
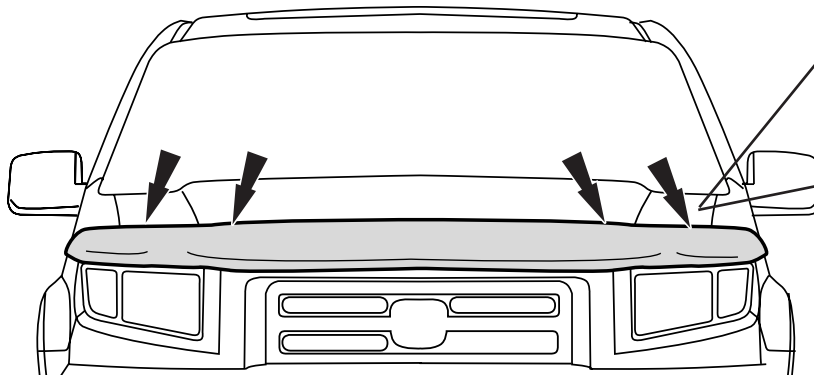

4

Care and Cleaning

- Wash only with mild soap & dry with a clean cloth.

Looking for dependable stone & bug deflectors?
Rely on Weathertech for quality and long-lasting products.