

# WeatherTech®

## Easy-On™ Stone & Bug Deflectors

### Important Safety Information



- CAUTION - Before driving, ensure that the hood shield is properly secured to vehicle.
- Do not use automatic “brush-style” car washes.
- Do not use cleaning solvents of any kind.
- Periodically check all components for tightness.

### Contents

**NOTE:** Actual product may vary from illustration.

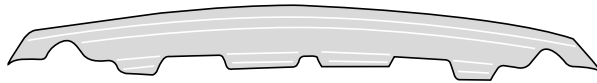

Hood shield



Bump On x4

### Tools Required



Car Wash Supplies



Clean Towel

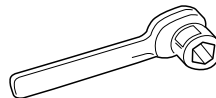

8 mm socket wrench

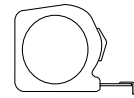

Measuring Tape

### Preparation Before Painting / Installation

- A trial fit is recommended to ensure proper positioning and fit.
- Check fit of parts before painting as we will not accept the return of modified or painted parts.
- Wash and dry your vehicle to remove any debris and/or dirt from the installation area.

### Installation Steps

**NOTE:** Actual application may vary slightly from illustrations.

Raise hood.

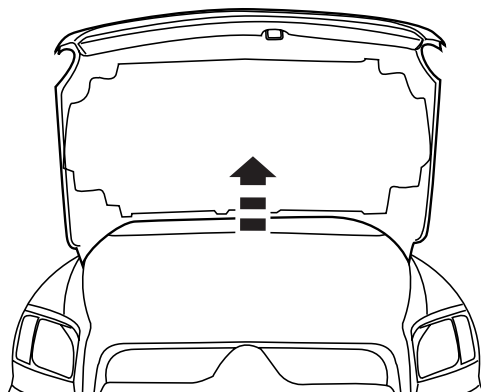

1



Loosen, but do not remove, (5) nuts securing grill to hood.

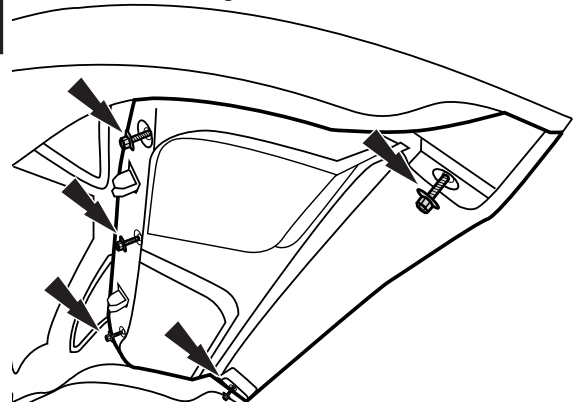

2

**Installation Steps** NOTE: Actual application may vary slightly from illustrations.

Squeeze tabs of (2) retaining clips together to release the locking tabs.

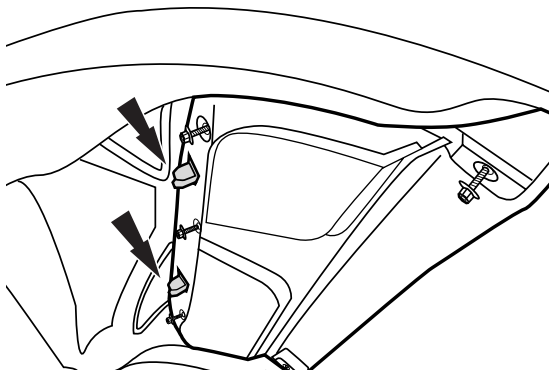

3



Lower the hood, and pivot the grill forward to create a 1/4" (.6 cm) gap between hood and grill.

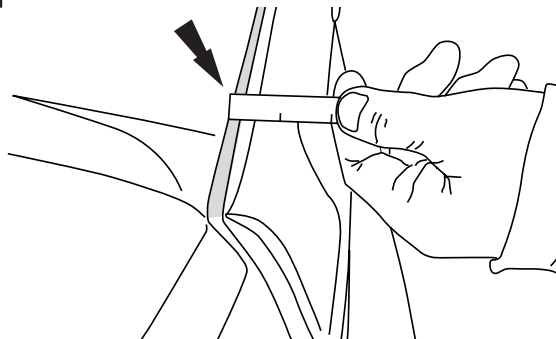

4

Slide the hood shield between the hood and grill, and center.

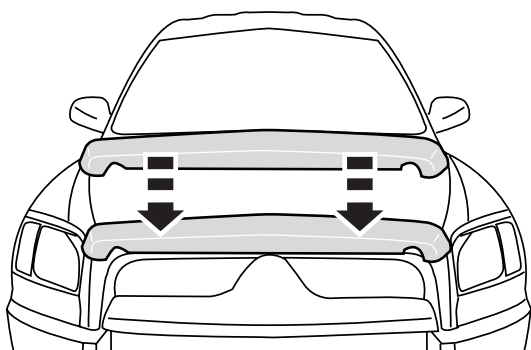

5



Raise hood, and retighten (5) previously loosened screws. Snap (2) retaining clips back into place.

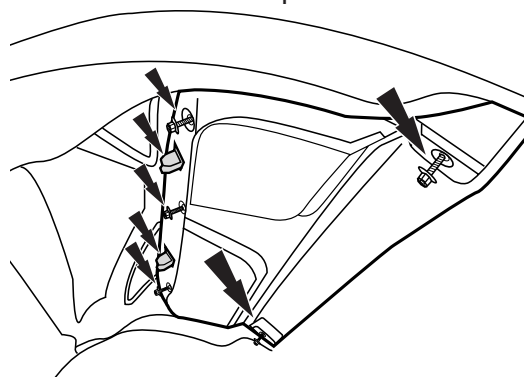

6



Install (4) bumpers on pre-cleaned areas of hood surface.

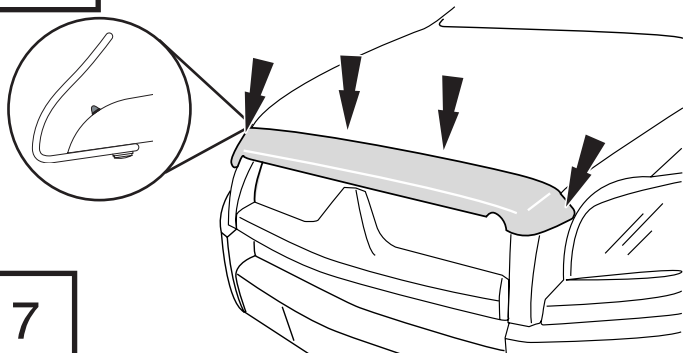

7

Looking for dependable stone & bug deflectors?  
Rely on Weathertech for quality and long-lasting products.