

WeatherTech®

Easy-On™ Stone & Bug Deflectors

Important Safety Information



- CAUTION - Before driving, ensure that the hood shield is properly secured to vehicle.
- Do not use automatic “brush-style” car washes.
- Do not use cleaning solvents of any kind.
- Periodically check all components for tightness.

Contents **NOTE:** Actual product may vary from illustration.

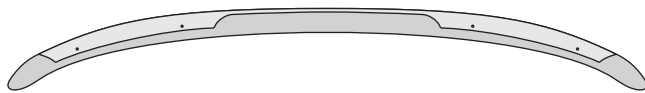

Hood Shield

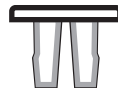

Hood Insert x4

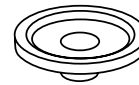

Grommet x4



Screw x4



Bump On x4

Tools Required



Car Wash Supplies



Clean Towel



Tape

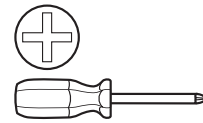

Phillips Screwdriver

Preparation Before Painting / Installation

- A trial fit is recommended to ensure proper positioning and fit.
- Check fit of parts before painting as we will not accept the return of modified or painted parts.
- Wash your vehicle to remove any debris and/or dirt from installation area.
- Dry the installation area with a clean towel.

Installation Steps **NOTE:** Actual application may vary slightly from illustrations.

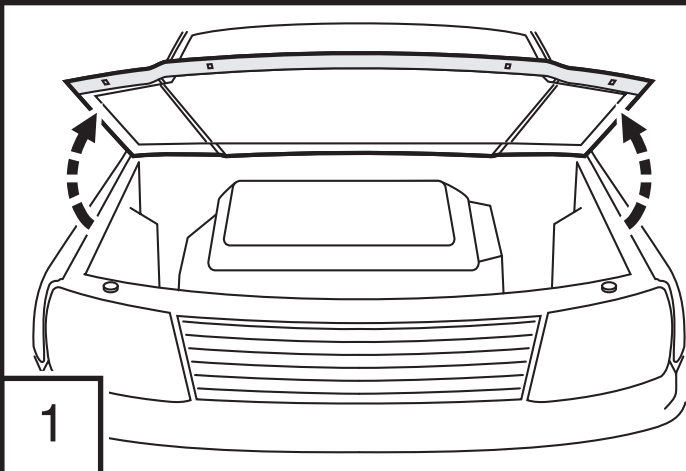

1

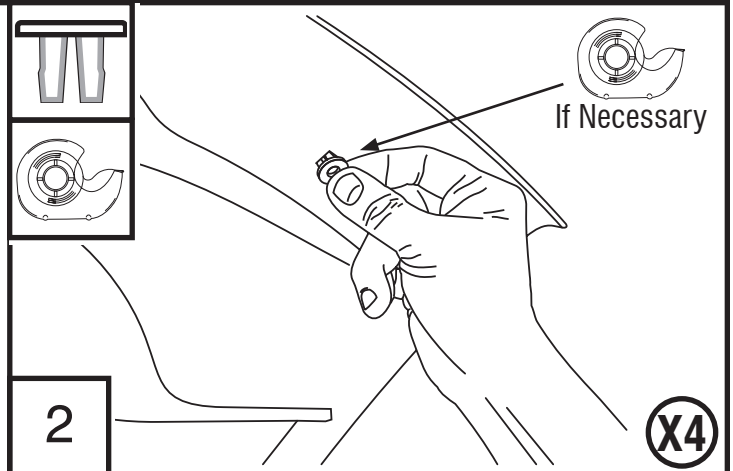

2

X4

Installation Steps

NOTE: Actual application may vary slightly from drawings.

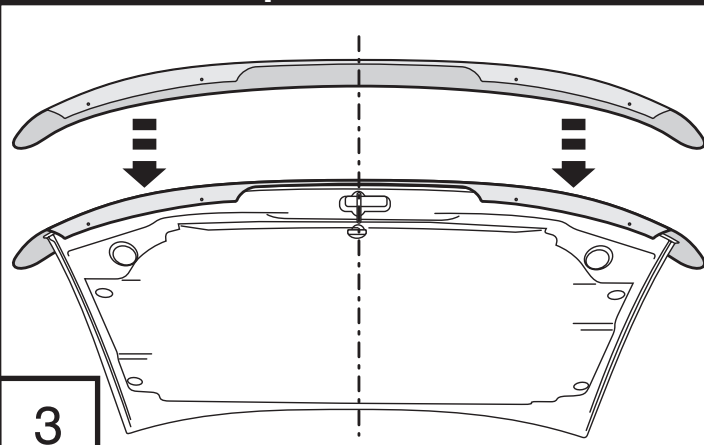

3

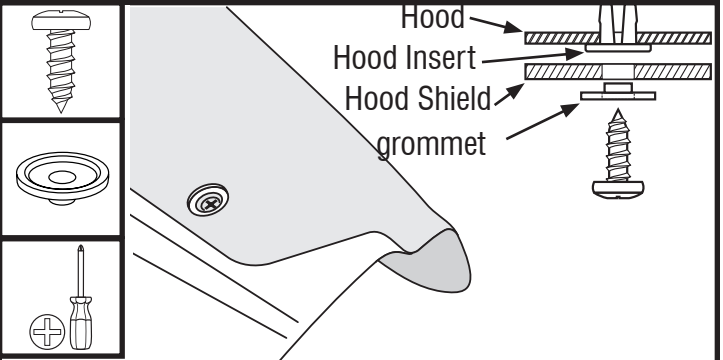

4

NOTE: Do No Overtighten

(X4)

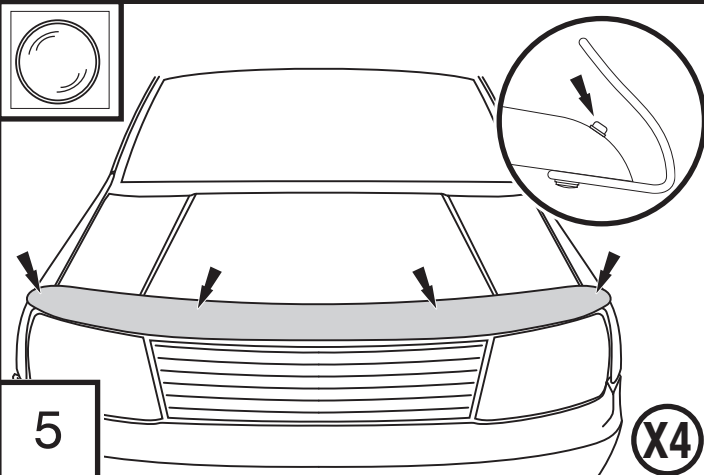

5

(X4)

Care and Cleaning

- Wash only with mild soap & dry with a clean cloth.