

# WeatherTech®

## Easy-On™ Stone & Bug Deflectors

### Important Safety Information



- CAUTION - Before driving, ensure that the hood shield is properly secured to vehicle.
- Do not use automatic “brush-style” car washes.
- Do not use cleaning solvents of any kind.
- Periodically check all components for tightness.

### Contents **NOTE:** Actual product may vary from illustration.

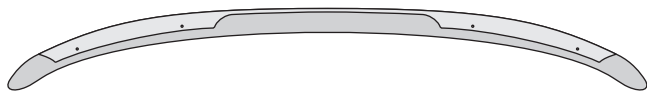

Hood Shield



Hood Insert x4

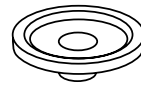

Grommet x4



Screw x4



Bump On x4

### Tools Required



Car Wash Supplies



Clean Towel



Tape

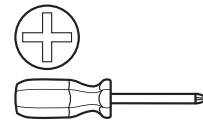

Phillips Screwdriver

### Preparation Before Painting / Installation

- A trial fit is recommended to ensure proper positioning and fit.
- Check fit of parts before painting as we will not accept the return of modified or painted parts.
- Wash your vehicle to remove any debris and/or dirt from installation area.
- Dry the installation area with a clean towel.

### Installation Steps **NOTE:** Actual application may vary slightly from illustrations.

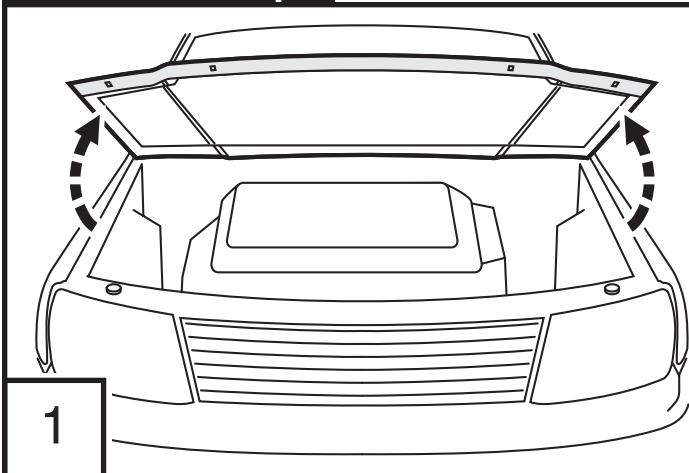

1

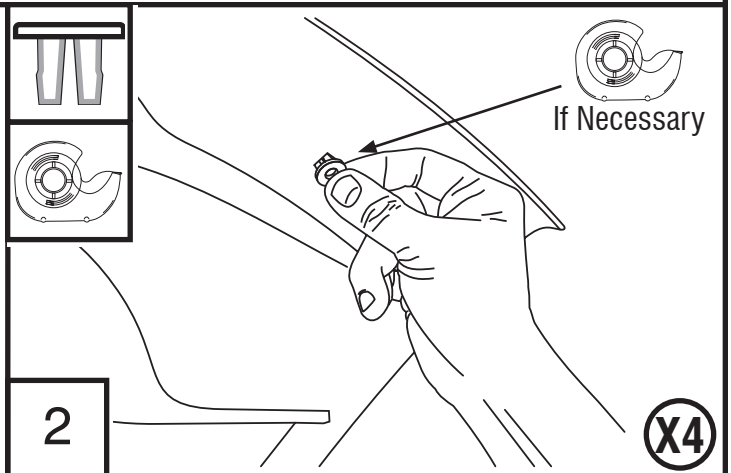

2

X4

## Installation Steps

**NOTE:** Actual application may vary slightly from drawings.

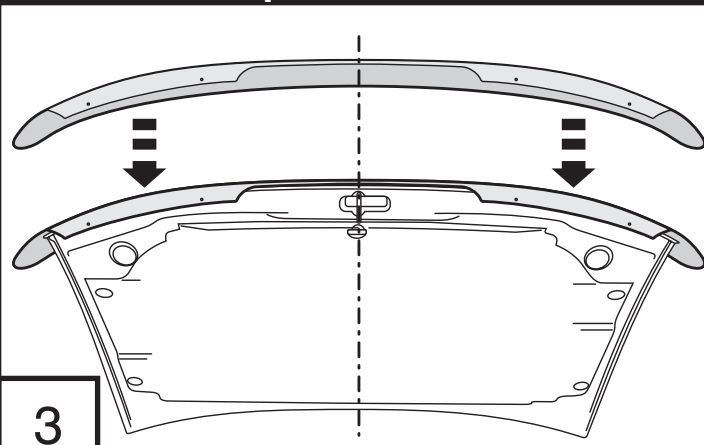

3

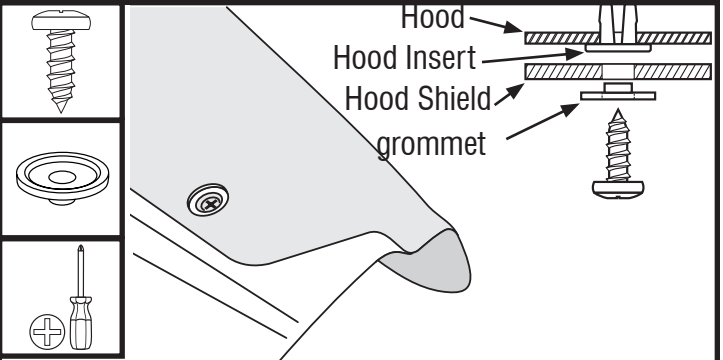

4

**NOTE:** Do No Overtighten

(X4)

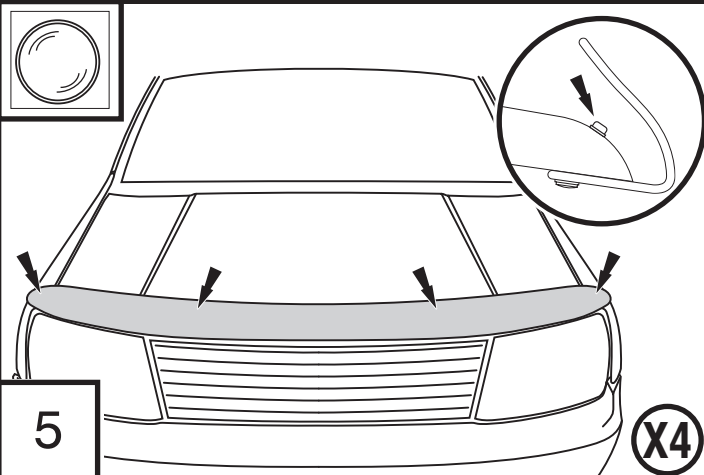

5

(X4)

## Care and Cleaning

- Wash only with mild soap & dry with a clean cloth.

Looking for dependable stone & bug deflectors?  
Rely on Weathertech for quality and long-lasting products.