

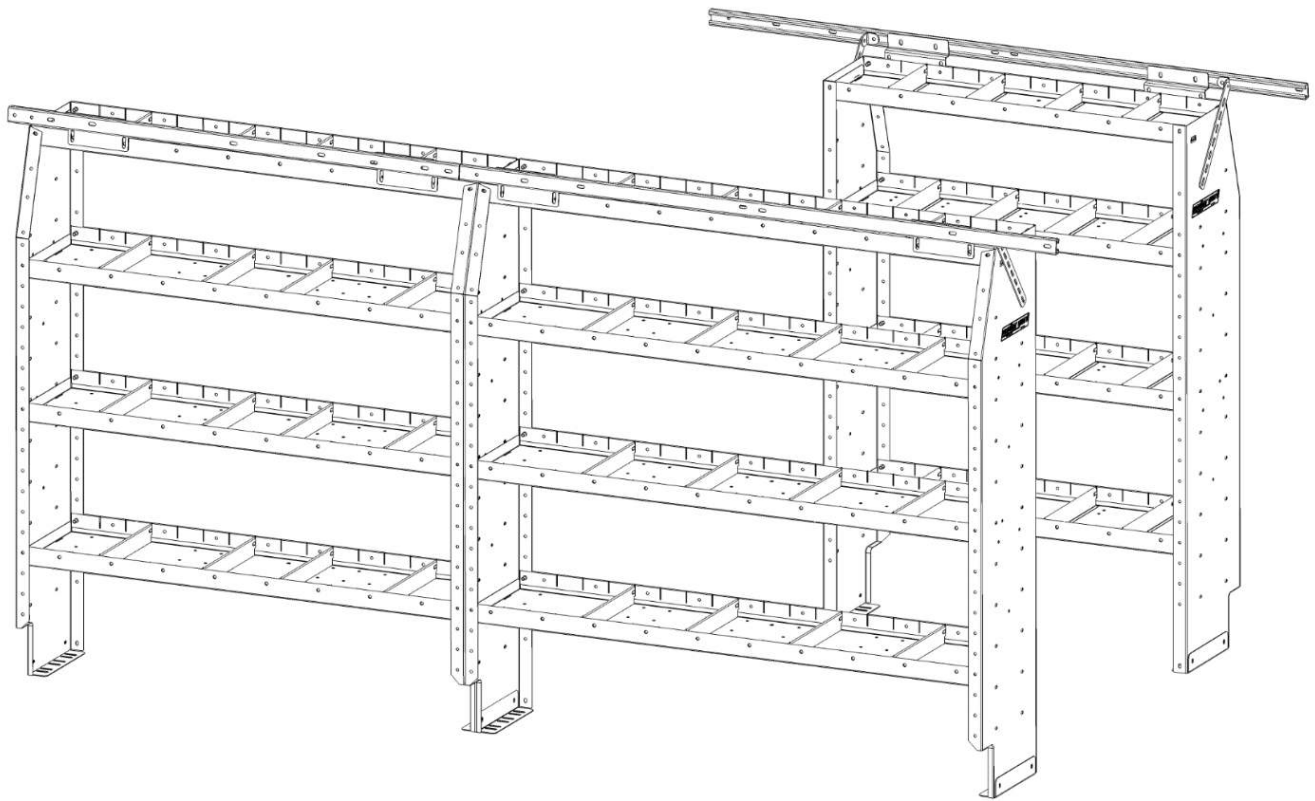

**VAN STORAGE SOLUTIONS**  
FOR THE WAY YOU WORK™

# INSTALLATION INSTRUCTIONS for FORD TRANSIT MID/HIGH ROOF SHELVING MOUNTING KIT



**ATTENTION: PLEASE READ AND UNDERSTAND ALL INSTRUCTIONS AND WARNINGS  
BEFORE ASSEMBLING, INSTALLING OR USING THIS PRODUCT.**



## PLAN YOUR VAN (TIPS FOR FASTER INSTALLATION)

- Follow these instructions to install your WEATHER GUARD® van shelving inside a Ford Transit mid or high roof van.
- Using this mounting kit you will be able to install the van shelving using factory installed weld nuts and mounting holes.
- Take into consideration any REDZONE end panel mounting accessories to be used and the desired location. The shelves can be easily adjusted.

## HARDWARE KIT

Description	Quantity
Mounting Plate	20
1/4"-20 x 3/4" Bolt	16
5/16"-18 x 1" Carriage Bolt	20
1/4"-20 Nylon Lock Nut	16
5/16"-18 Nylon Lock Nut	20
1/4" Washer	16
3/8" Spacer	12
3/4" Spacer	12
Blind Fastener Install Tool	1
1/4"-20 x 2-1/4" Bolt	12
5/16" Washer	37
M8-1.25 x 35mm Socket Cap Screw	17
M8-1.25 Blind Fastener	7
M-8-1.25 x 55mm Bolt	1

## TOOLS REQUIRED

5mm Allen Wrench	Electric drill
7/16" Socket	Center punch
7/16" Wrench	Hammer
1/2" Socket	1/4" drill bit
1/2" Wrench	3/8" drill bit
9/16" Wrench	1/2" drill bit
Level	Torque wrench
Marker	1" hole saw

## CAUTION

Be safe—always wear protective eyewear to keep debris out of your eyes when installing WEATHER GUARD® van products.

## PARTS LIST

### 975103-3-01 130" WB Mid Roof Transit

Description	Quantity
Bracket (common)	6
Rear Mounting Channel (51.375")	2
Front Mounting Channel (52.5")	1

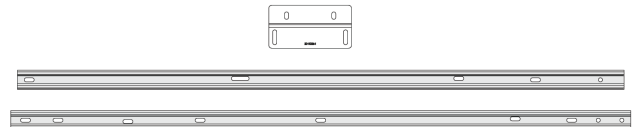

### 975104-3-01 148" WB Mid/High Roof Transit

Description	Quantity
Bracket (common)	6
Rear Mounting Channel (68.925")	2
Front Mounting Channel (52.5")	1

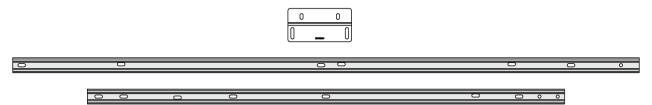

### 975105-3-01 148" EXT WB High Roof Transit

Description	Quantity
Bracket (common)	8
Rear Mounting Channel (97.375")	2
Front Mounting Channel (52.5")	1

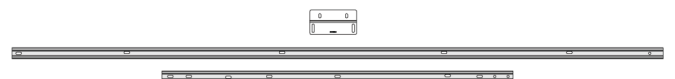

\* Images not to scale.

## MOUNTING KIT ASSEMBLY AND INSTALLATION INSTRUCTIONS

- The mounting channels will bolt to the upper inside wall of the van using a combination of factory installed weld nuts and blind fasteners.
- Front mounting channel (driver side) is common across all Transit models.
- Rear mounting channels install similarly but have different lengths and weld nut locations.
- The Weather Guard Van Installation Kit is compatible with OEM interior trim kit. Remove upper row of panels prior to installation of the mounting channels.

**STEP 1.** Mount Front (driver side) channel. \*Note: Front channel is common on all wheelbase mounting kits.

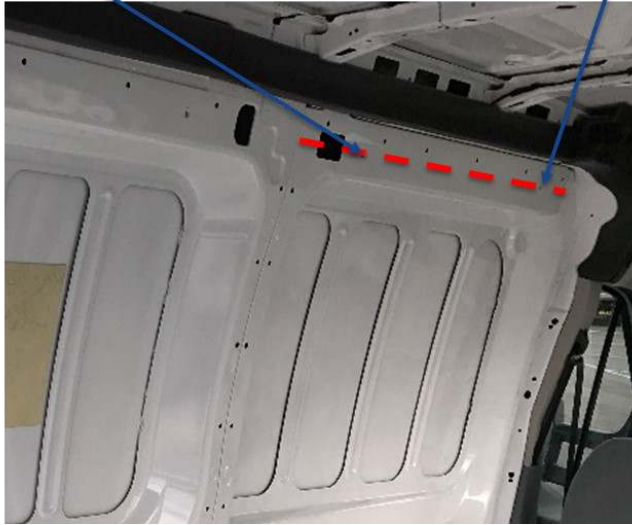
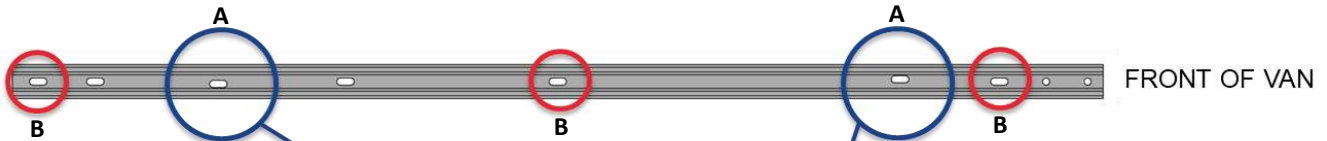

- Using two M8 bolts and washers, attach the mounting channel to the van using a 5mm Allen wrench through **A** slots. Do not completely tighten.
- Mark the locations for blind fasteners. (**B** slots)

**STEP 2a.** Mount Rear (driver side) channel for **130" wheelbase mid/high roof (975103-3-01)**.

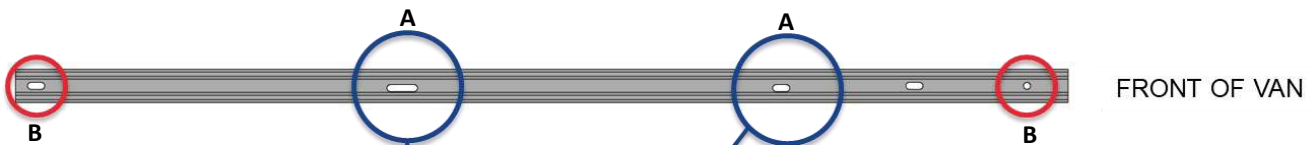

- Using two M8 bolts and washers, attach the mounting channel to the van using a 5mm Allen wrench through **A** slots. Do not completely tighten.
- Mark the locations for blind fasteners. (**B** slot/hole)

## MOUNTING KIT ASSEMBLY AND INSTALLATION INSTRUCTIONS

### STEP 2b. Mount Rear (driver side) channel for 148" wheelbase mid/high roof (975104-3-01).

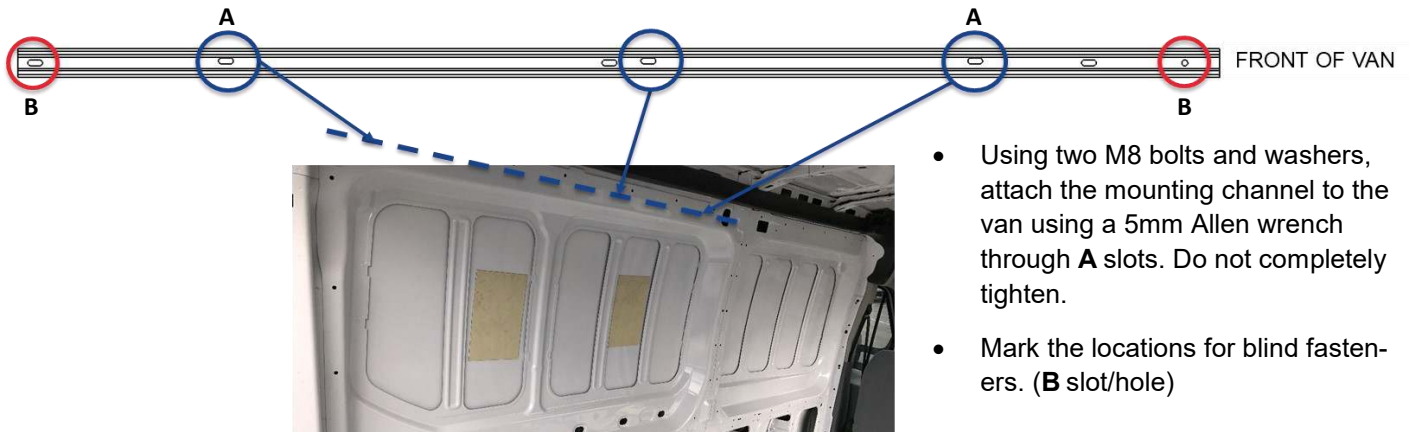

- Using two M8 bolts and washers, attach the mounting channel to the van using a 5mm Allen wrench through **A** slots. Do not completely tighten.
- Mark the locations for blind fasteners. (**B** slot/hole)

### STEP 2c. Mount Rear (driver side) channel for 148" extended wheelbase high roof (975105-3-01).



- Using two M8 bolts and washers, attach the mounting channel to the van using a 5mm Allen wrench through **A** slots. Do not completely tighten.
- Mark the locations for blind fasteners. (**B** slot/hole)

### STEP 3. Mount passenger side channels (same channel used in STEP 2a, 2b, 2c). The end with a hole remains the front of the channel for the passenger side. The same slots are used for M8-1.25 bolts and for marking blind fastener location.

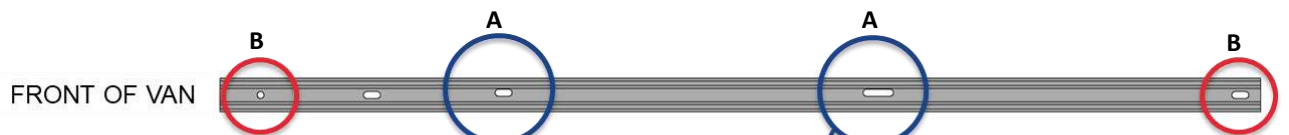

- 130" wheelbase passenger side shown.
- Using M8 bolts and washers, attach the mounting channel to the van using a 5mm Allen wrench through **A** slots. Do not completely tighten.
- Mark the locations for blind fasteners. (**B** slot/hole)



## MOUNTING KIT ASSEMBLY AND INSTALLATION INSTRUCTIONS

**STEP 4.** Install blind fasteners in **B** slots/hole.

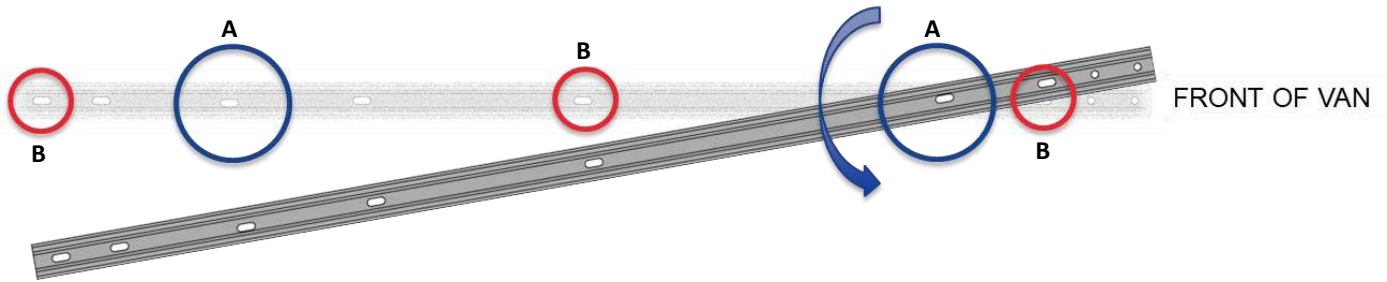

- Remove all but the front-most M8 bolt and tighten the front-most M8 bolt such that the channel can rotate and stay in position to expose the previously marked points for blind fasteners.
- Use the center punch and hammer to make a register mark for your drill bit.
- Before drilling for blind fasteners, check to make sure you won't be damaging wiring, gas lines, or other critical vehicle systems.
- Too much pressure while drilling or setting the blind fasteners may cause dimples in the body panel around the install location.
- Use 1/4" drill bit to make pilot holes.
- Use 1/2" drill bit on pilot holes for blind fastener.
- Install blind fasteners using procedure shown below.

Use 13mm socket (M8)  
or 7/16" socket (1/4-20)

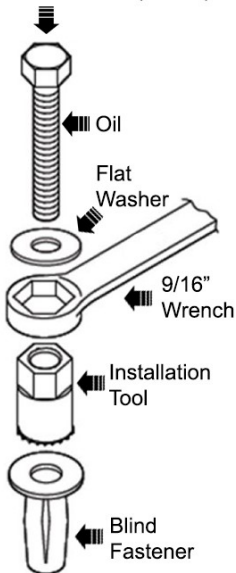

### INSTALLATION PROCEDURE USING BLIND FASTENERS

Place a drop of oil on the M8-1.25 x 55mm or 1/4-20 x bolt before assembling as shown on left.

Place the Blind Fastener in the hole and use a 13mm when installing M8 Blind Fastener or 7/16" socket when installing 1/4-20 Blind Fastener and driver to tighten the bolt until the Blind Fastener is fully seated.

When setting the bolt, it will start out tight. As the Blind Fastener "bulbs" out it will get easier, until it bottoms out of sets.

Make sure the Blind Fastener and the installation tool do not slip during the installation.

## MOUNTING KIT ASSEMBLY AND INSTALLATION INSTRUCTIONS

- Optional.** For vans equipped with OEM interior panels, remove the mounting channel, install M8 bolts flush to van wall. Place the interior panels over the bolts by installing OEM plastic fasteners on upper corners to hold them in place. Firmly press where the bolt heads are located to indent the OEM panels. Remove the panels and make 1/2" holes on marked points. Remove the M8 bolts. Reinstall OEM panels.
- STEP 5.** Secure mounting channels to the factory weld nuts and blind fasteners using 5mm Allen head bolts and washers. Level the channels before tightening them down. Torque to 20 ft-lbs.
- STEP 6.** Position pre-assembled shelving (minus mounting feet) inside the van. Plan out positioning of the shelves and accessories relative to bulkhead and wheel well.





## MOUNTING KIT ASSEMBLY AND INSTALLATION INSTRUCTIONS

- STEP 7.** Assemble two mounting brackets to the back of the top shelf lip on outer-most position shown below using two 1/4-20 x 3/4" bolts, washers, and nylon lock nuts. Use 3/4" and 3/8" spacers with 1/4-20 x 2-1/2" bolts when the end panel interferes with the C-pillar on the driver side. Do not torque them down at this point.

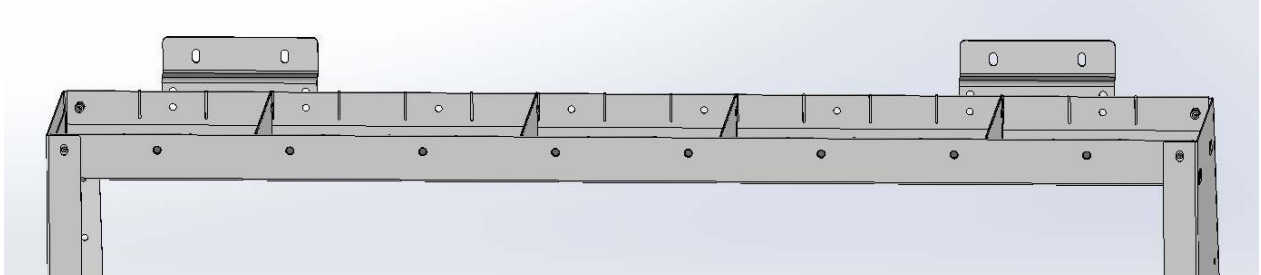

- STEP 8.** Position the carriage bolt plate such that you can read the word "TOP" and insert 5/16-18 carriage bolt from the bottom of the plate. Note: using a piece of masking tape (or equivalent) on back of the plate to lightly hold the carriage bolt to the plate may allow easier installation. You will need four plates per shelving unit plus two for each side (driver/passenger) for the end straps.



## MOUNTING KIT ASSEMBLY AND INSTALLATION INSTRUCTIONS

- STEP 9.** Insert the carriage bolt/plate assemblies through the mounting channel and rotate 90 degrees clockwise. Ten will be used on driver side and six will be used on passenger side when installing standard configuration of two and one shelving for driver side and passenger side, respectively. Note: 148" EXT Vans use three shelves on the driver side, thus, will require 14 carriage bolts/plates on driver side.

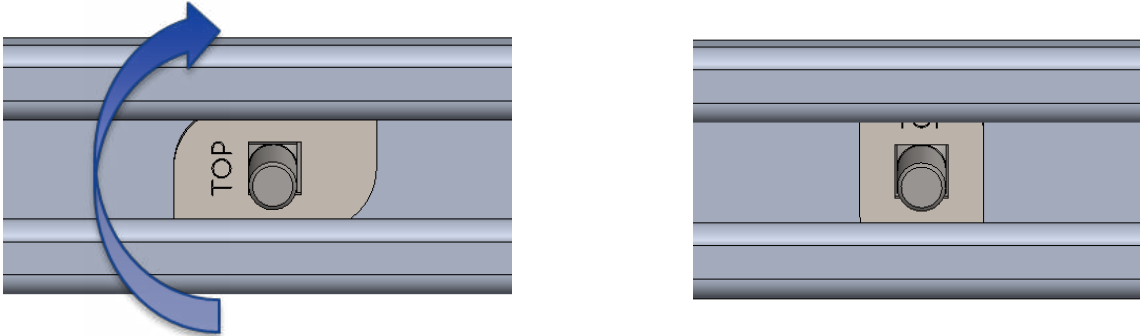

- STEP 10.** Position the shelves and carriage bolts/plates in desired location and fasten the shelves to the carriage bolt/plate using 5/16-18 nylon lock nuts and washers using 1/2" socket. Fine tune the position and alignment of the shelves in desired location. Torque them down to 13 ft-lbs.



- STEP 11.** The hardware from the shelf unit is used to mount the shelf to the floor. Place the mounting foot to the inside of the end panel and mark drilling points. Use a spacer when mounting on uneven surface as shown below. If the van is equipped with floor mats or has a composite floor, use a 1" hole saw to open a hole for the spacer and mounting hole. Use a 1/4" drill bit for pilot and 3/8" drill for 1/4-20 blind fasteners. Install 1/4-20 blind fasteners on the floor. Refer to blind fastener instruction on page 5. **Always be sure to make sure you won't be damaging wiring, gas lines, or other critical vehicle systems when drilling.**

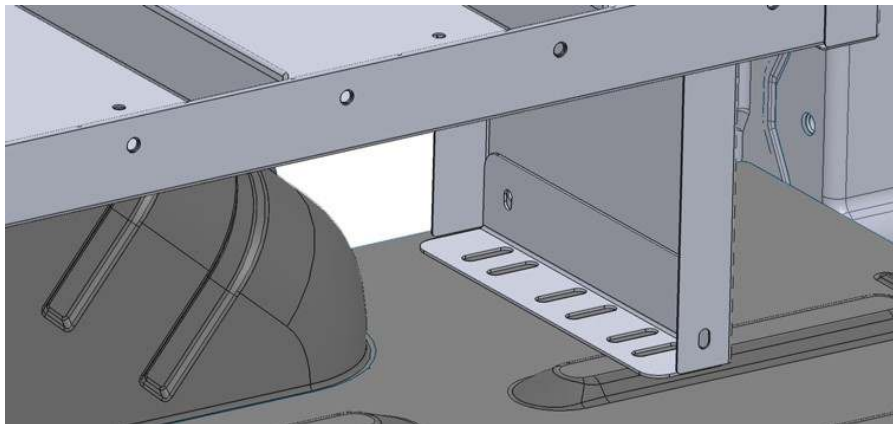



## MOUNTING KIT ASSEMBLY AND INSTALLATION INSTRUCTIONS

**STEP 12.** Slip the mounting foot from the other side of the end panel and install using 1/4-20 x 3/4" bolts, washers, and nylon lock nuts. Install to floor blind fasteners using 1/4-20 x 1-1/2" bolts. Repeat steps 11 and 12 until all mounting feet are installed. Note that you only need to use one mounting foot where the driver side shelves join.

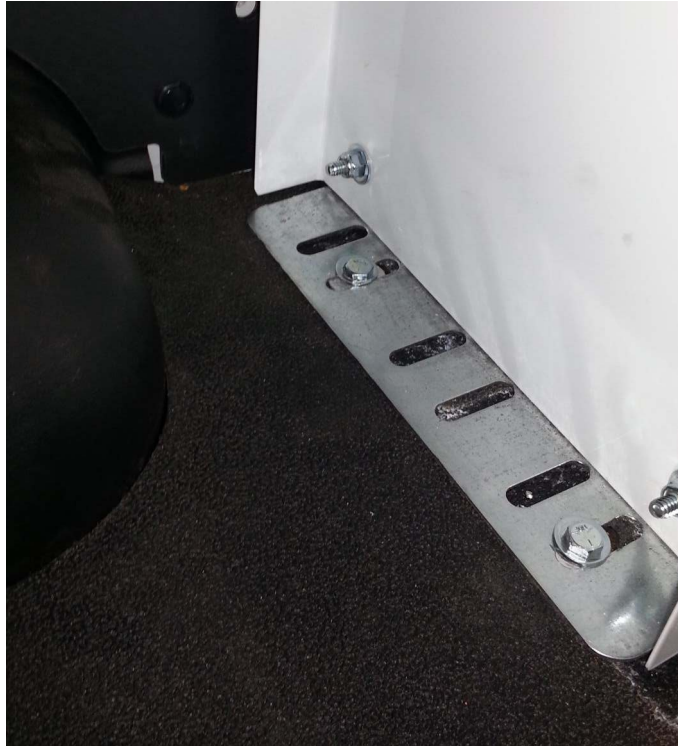

**STEP 13.** Torque down the 1/4-20 x 3/4" bolts, washers, and nylon lock nuts installed in **STEP 7** to 76 in-lbs.



## MOUNTING KIT ASSEMBLY AND INSTALLATION INSTRUCTIONS

- STEP 14.** Loosely assemble L-bracket for the end straps to the carriage bolt/plate assembled in **STEP 8**. L-brackets and end straps are included with the shelf. Use washer and 5/16-18 nylon lock nut using 1/2" socket. The face of the L-bracket that is perpendicular to the mounting channel may face front or rear of the van depending on the shelf size and configuration.



- STEP 15.** Install the end strap to the L-bracket using 1/4-20 x 3/4" bolt, washer, and nylon lock nut using 7/16" wrench and socket. Position the strap such that it is inline with the end panel. Align the end strap to one of the holes on the end panel and secure it using 1/4-20 x 3/4" bolt, washer, and nylon lock nut. Make sure all components are aligned and tighten.



- STEP 16.** Make sure all shelves are aligned and make sure all bolts and nuts are properly torqued to spec. use 76 in-lbs for 1/4-20 hardware and 13 ft-lbs for 5/16-18 hardware.