



TRUCK STORAGE SOLUTIONS
SECURING YOUR REPUTATION

INSTALLATION MANUAL

ALUMINUM & STEEL SADDLE/CROSS BOXES

ATTENTION: PLEASE READ AND UNDERSTAND ALL INSTRUCTIONS AND WARNINGS BEFORE ASSEMBLING, INSTALLING OR USING THIS PRODUCT.



⚠ WARNING
Please read page 2 before inserting the provided keys into any of the locks.

⚠ NOTICE

Use specific aluminum upfit components when installing WEATHER GUARD® products to aluminum truck beds. Follow additional instructions if mounting to an aluminum truck bed. There may be left over components depending on upfit.

Any modification or unintended use of this product shall immediately void all manufacturers warranties. Manufacturer disclaims all liability for injuries to persons or property resulting from any modification to, or unintended use of this product.

⚠ DANGER

Danger of explosion. Do not use this product for storing or transporting flammables, explosives, hazardous materials, or hazardous waste, such as containers of gasoline, solvents, gun powder, dynamite, propane tanks, acetylene tanks and cutting torches. This product is only intended and safe for use in storing and transporting small tools, equipment and other similar materials. Any modifications made to, or unintended use of this product, could create a hazardous condition that can cause death, serious personal injury or property damage.

READ AND UNDERSTAND ALL INSTRUCTIONS BEFORE INSERTING A KEY INTO THE LOCKS

This box has code-able locks installed. These locks have no pre-set key code, and only the keys provided can be used to code the locks. These locks will “learn” the code, and only the code, of the first key that the lock is coded with (see CODING THE LOCKS below). One set of keys will be provided per box.

If you have multiple boxes with code-able locks, you can:

1. Code each of the boxes with a single key. All other keys without the same code cannot be used.

OR

2. Code each box or set of boxes with their own set of keys.

Any new additional boxes with code-able locks, can be coded with the keys from your original box.

⚠️ WARNING: ONCE A LOCK IS CODED IT CANNOT BE CHANGED! ⚠️

CODING THE LOCKS - Easy 3-step guide

① START

Read, then remove the label, open box lid, then insert key.

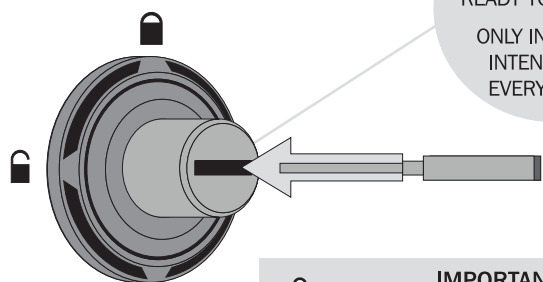

WARNING
DO NOT REMOVE UNTIL
READY TO CODE GRV
ONLY INSERT KEY
INTENDED FOR
EVERYDAY USE

IMPORTANT:
Once a lock is coded it cannot be changed.
Make sure to register your key code

② CODING THE LOCK

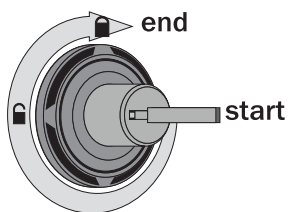

Turn key clockwise a full 3 quarters of a circle

USEFUL HINT:
When the key is coding there will be a 'clicking' sound

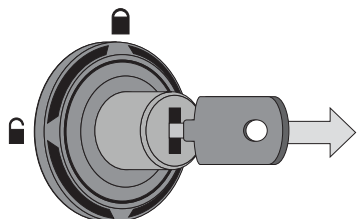

The box is now locked with the key **permanently** coded.
Remove key.

③ TESTING THE LOCK

Fully insert key again.

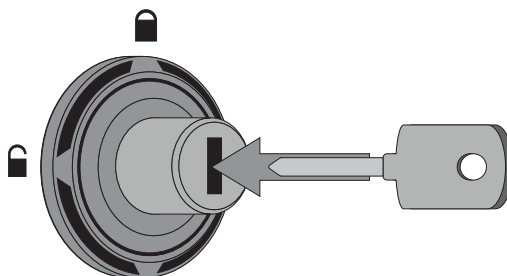

Turn key counter-clockwise 1/4 turn to unlock.

Turn key clockwise 1/4 turn to lock.

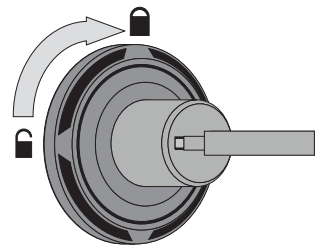
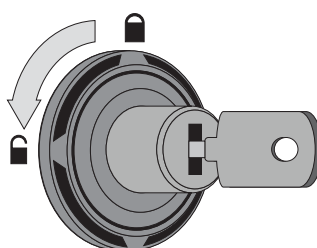

USEFUL HINT:
Lock and unlock the box 5 times to ensure it works.
Remove key fully between each test.



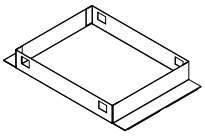

TOOLS REQUIRED

- Ratchet Wrench - 1/2"
- Ruler

PARTS LIST

 (2) Key	 (1) Tray			
---	--	--	--	--

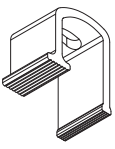
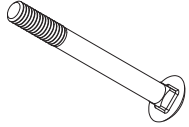
BOLT KIT

 (4) Fender Washer	 (4) Retaining Washer	 (4) Mounting Clamp	 (4) 5/16-18 x 3" Carriage Bolt	 (4) 5/16-18 Nylon Lock Nut
---	--	--	--	--

INSTALLATION INSTRUCTIONS

Note:

- If the pickup is fitted with a plastic drop-in bed liner, it may need to be drilled, trimmed, or cut for proper installation of truck box.
- Truck box cover may not properly latch until box is fully bolted to truck bed in (4) places.
- Because truck bed configurations vary, (8) mounting slots have been provided, to ensure the use of (4) mounting clamps.
- Periodically check tightness of mounting clamps to ensure proper attachment.
- Use touch-up paint on any drill holes to prevent oxidation.
- Install boxes with vehicle parked on level ground.

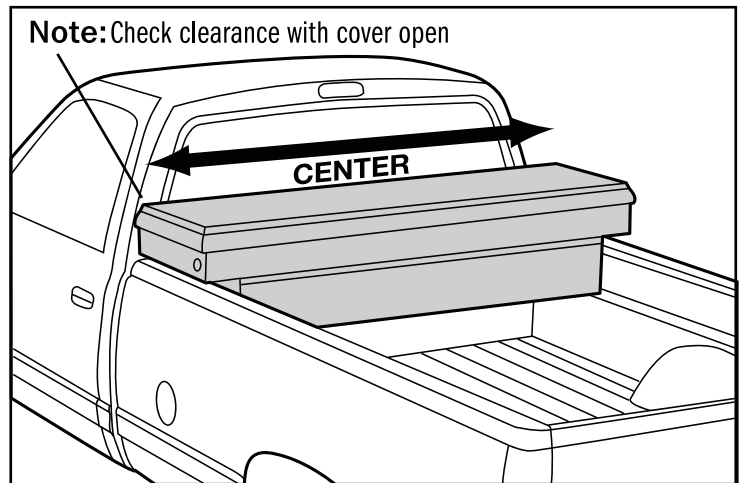

STEP 1 Locate Box in Truck Bed

Place box into position on top of the bed rails. Use ruler to ensure box is centered in truck bed and that cover opens fully without interference.

ALUMINUM TRUCK BED INSTALLATION:

If you drill holes into an aluminum truck bed to use through bolts or J-bolts, use zinc rich primer (not included) to coat the holes before assembly.

STEP 2 Attach Box to Truck Bed

Attach mounting clamp, bolts, and washers as shown in figure to the right. Start with slot at drivers side front and work clock-wise until all four clamps have been installed.

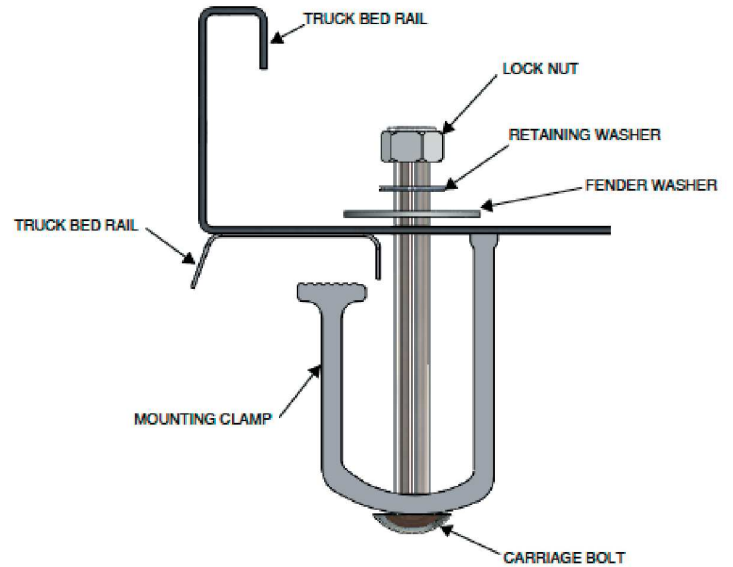

Lock System

The WEATHER GUARD® Extreme Protection™ Lock is designed to provide maximum security, while providing ease of use and years of reliable service. When the button is pressed in the unlock mode, the latches are activated and the cover opens.

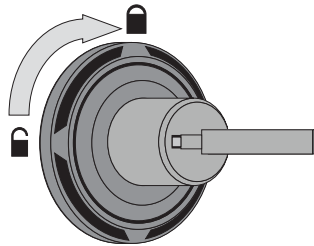

Lock

Turn the key clockwise to the locked position as indicated on the lock bezel.

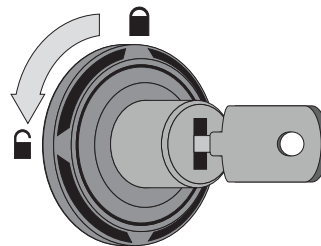

Unlock

Turn the key counter-clockwise to the unlocked position as indicated on the lock bezel. It is now ready to release the latches when pressed.

Latch System

The WEATHER GUARD® Latch System utilizes automotive grade latches in conjunction with high strength latch strikers to ensure maximum security. The WEATHER GUARD® Latch System is designed to open with a single touch of the button, and close securely. Expect years of reliable service from the WEATHER GUARD® Latch System with only minimal maintenance: Lubricate latch pivot points bi-annually with white grease. If latch strikers are accidentally knocked out of alignment, simply use a mallet to re-align.

12V Electrical Access

WEATHER GUARD® Truck Boxes are equipped with a 12 volt electrical access grommet for easy electrical accessory fit-ups. To use, simply cut along one or more perforations in the rubber grommet and run wire through.

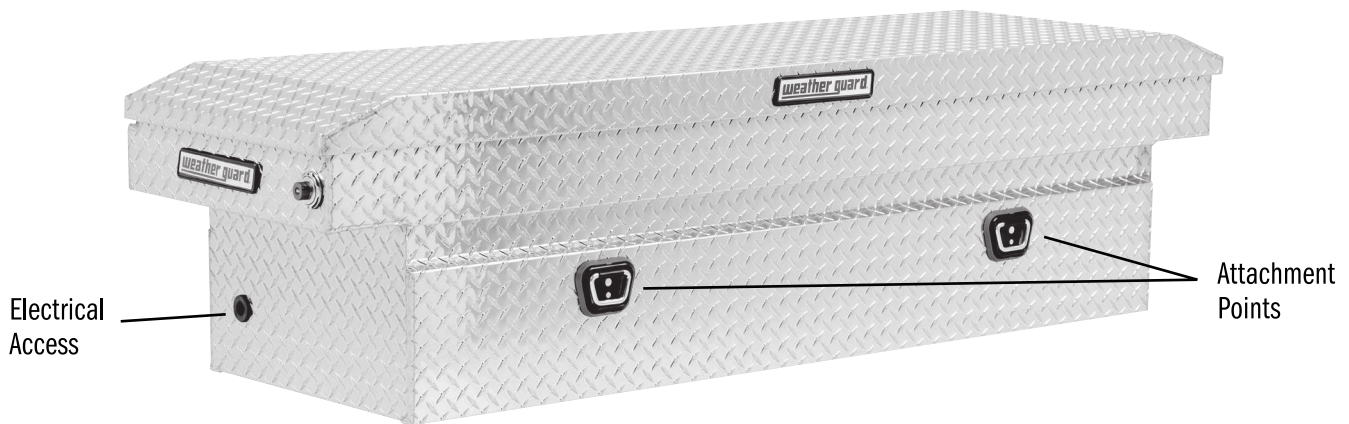

WARNING

Extension Cord

- Follow all Extension Cord manufacturer's warnings and instructions.
- DO NOT insert extension cord through hole without grommet in place.
- Only use a three-wire extension cord with all three prongs intact. Never remove the round grounding prong.
- Extension cord must be connected to a 120 Volt GFCI protected outlet with proper ground. If GFCI outlet is not available, use an extension cord with GFCI protection built in.
- Check the insulation and plugs of extension cord before using. DO NOT use cord if it is worn or damaged.
- DO NOT overload extension cord.
- Remove extension cord from the grommet hole before moving or transporting saddle/cross box.
- Only use an extension cord that is rated for outdoor use.
- DO NOT connect extension cord to outlet that also supplies critical safety equipment with power.

Cordless Power Tool Battery Chargers

- See Charger's Owner's Manual for proper use and care of charger and batteries. Follow all warnings and instructions provided with your battery charger.
- Chargers are dry location use only. DO NOT expose to liquid, vapor or rain. Should your charger become wet, DO NOT attempt to use.
- Unplug extension cord from supply before handling wet charger or cords.
- Only use chargers and batteries that are intact and operating properly.
- DO NOT touch metal prongs when plugging charger into extension cord.
- Keep flammable materials like paper or rags away from charger, cords or connections.
- DO NOT place or attempt to charge lead acid, car type batteries in saddle/ cross box.