



# INSTALLATION INSTRUCTIONS

## WINCH MOUNTING KIT

Part Number: 84704

Application: Honda Rancher TRX420

Your safety, and the safety of others, is very important. To help you make informed decisions about safety, we have provided installation and operating instructions and other information on labels and in this guide. This information alerts you to potential hazards that could hurt you or others. It is not possible to warn you about all potential hazards associated with this product, you must use your own good judgment.

**CARELESS INSTALLATION AND OPERATION CAN RESULT IN SERIOUS INJURY OR EQUIPMENT DAMAGE. READ AND UNDERSTAND ALL SAFETY PRECAUTIONS AND OPERATING INSTRUCTIONS BEFORE INSTALLING AND OPERATING THIS PRODUCT.**

This guide identifies potential hazards and has important safety messages that help you and others avoid personal injury or death. **WARNING** and **CAUTION** are signal words that identify the level of hazard. These signal words mean:

**WARNING** signals a hazard that *could* cause serious injury or death, if you do not follow recommendations. **CAUTION** signals a hazard that *may* cause minor to moderate injury, if you do not follow recommendations.

This guide uses **NOTICE** to call attention to important mechanical information, and **Note**: to emphasize general information worthy of special attention.

### **WARNING**

#### **INJURY HAZARD**

**Failure to observe these instructions could lead to severe injury or death.**

- ❑ **Always** use extreme caution when drilling on any vehicle. Make sure that all fuel lines, brake lines, electrical wires, and other objects are not punctured or damaged when / if drilling on the vehicle. Thoroughly inspect the area to be drilled (on both sides of material) prior to drilling, and relocate any objects that may be damaged. Failure to inspect the area to be drilled may result in vehicle damage, electrical shock, fire or personal injury.
- ❑ **Always** wear safety glasses when installing this kit. A drilling operation will cause flying metal chips. Flying chips can cause eye injury.
- ❑ **Always** use extreme caution when cutting and trimming during fitting.
- ❑ **Always** remove jewelry and wear eye protection.
- ❑ **Never** lean over battery while making connections.
- ❑ **Never route electrical cables:**
  - Across any sharp edges.
  - Through or near moving parts.
  - Near parts that become hot.
- ❑ **Always** insulate and protect all exposed wiring and electrical terminals.
- ❑ **Always** install terminal boots as directed in installation instructions.
- ❑ **Always** use appropriate and adequate care in lifting components into place.
- ❑ **Always** insure components will remain secure during installation and operation.
- ❑ **Always** tighten all nuts and bolts securely, per the installation and operation.
- ❑ **Always** perform regular inspections and maintenance on the winch, winch mount and related hardware.
- ❑ **Never** operate this **WARN** product with damaged or missing parts.

<b>⚠ Caution</b>
<b>Moving Parts Entanglement Hazard</b>
<b>Failure to observe these instructions could lead to minor or moderate injury.</b>
<input type="checkbox"/> <b>Always</b> take time to fully read and understand the installation and Operations Guide included with this product. <input type="checkbox"/> <b>Never</b> operate this product if you are under 16 years of age. <input type="checkbox"/> <b>Never</b> operate this product when under the influence of drugs, alcohol or medications.
<b>Read installation and operating instructions thoroughly.</b>

<b>Notice</b>
<b>Equipment Damage</b>
<input type="checkbox"/> <b>Always</b> refer to the Installation and Specification Guide, supplied in the winch kit, for all wiring schematics and specific details on how to wire this WARN product to your vehicle.
<b>Read installation and operating instructions thoroughly.</b>

## Before You Begin

This kit is compatible with the WARN's line of ATV winches. Winch is sold separately. Please read WARN's Winching Technique guide provided with the winch prior to use of this product.

## Table of Contents

I.	Parts List.....	3
II.	Tools Required.....	3
III.	Rancher TRX420 Installation.....	4-11
IV.	Winch Wiring.....	12
V.	TRX 420 Specific Wiring Instructions.....	13-16
VI.	Maintenance/Care .....	17

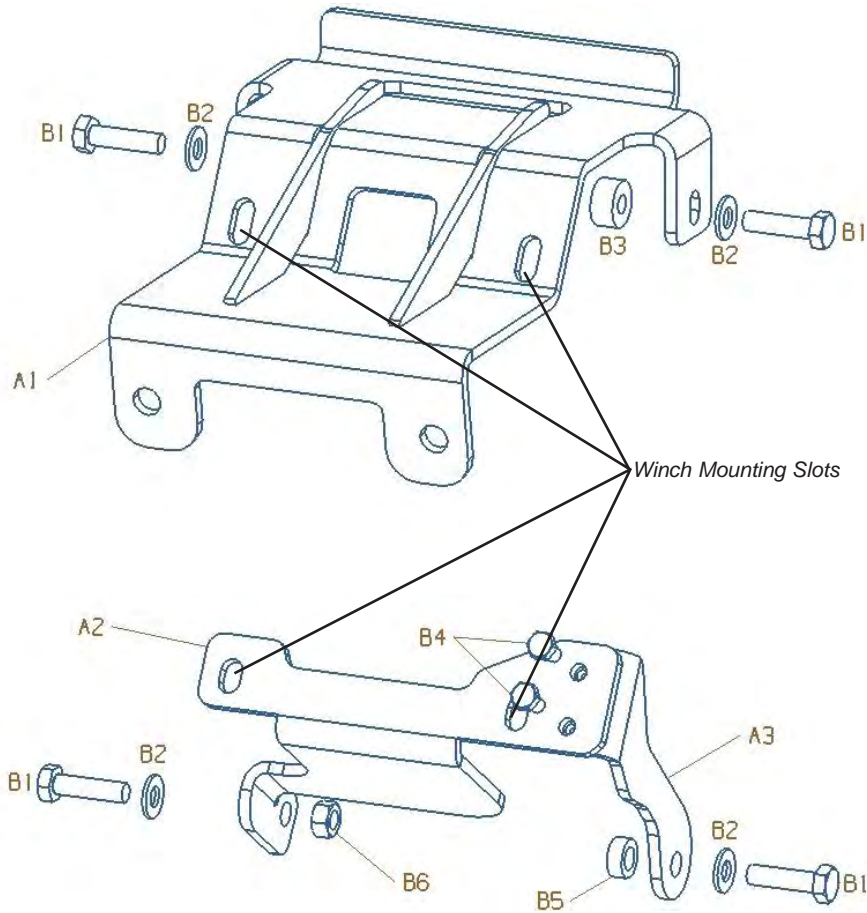

## I. Parts List

<u>Ref</u>	<u>Description</u>	<u>Qty</u>
A1	Upper Mounting Bracket	1
A2	Lower Mounting Bracket	1
A3	Side Mounting Bracket	1
B1	8mm-1.25 x 30mm Bolt	4
B2	8mm Flat Washer	8
B3	9.5mm (3/8") Spacer	2
B4	6mm - 1.00 x 12mm Bolt	2
B5	6.3mm (1/4") Spacer	1
B6	8mm-1.25 Lock Nut	1
	1/4-20 x 1" x 1 3/4" U-bolt	2
	1/4-20 Lock Nut	4
	1/4 Flat Washer	4

## II. Tools Required

- Ratchet
- Sockets: 10mm, 12mm, 13mm, 7/16"
- Wrenches: 10mm, 13mm, (2) 14mm, 3/8", 7/16"
- Screwdrivers: Slotted, Phillips
- Allen Wrenches: 1/8", 5mm
- Sidecutters or Saw
- Voltmeter or Test Light
- Electric Tape

### III. Rancher TRX420 Installation

1. Begin by removing the two plastic rivets on each side of the front plastic fascia, figure 1. Use a large screw driver to carefully remove the center rivet. After removing the center rivet, remove the rivet housing. Save the fasteners as they will be used to reinstall the front plastic fascia.

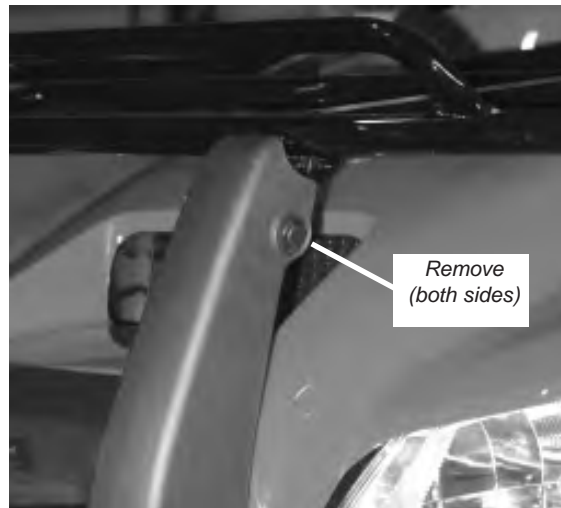

Figure 1 Remove the Two Plastic Rivets

2. Remove the two side 6mm bolts securing the front fascia, figure 2. Save the fasteners as they will be used later to reinstall the front fascia. Remove the front plastic fascia.

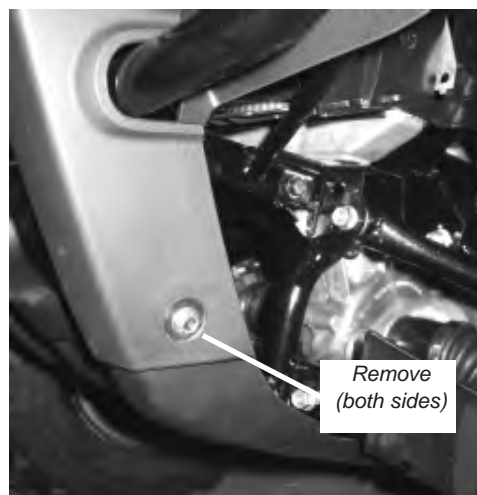

Figure 2 Remove Front Fascia

3. Remove the four 6mm bolts that secure the front skid plate, figure 3. Save the fasteners as they will be reinstalled later.

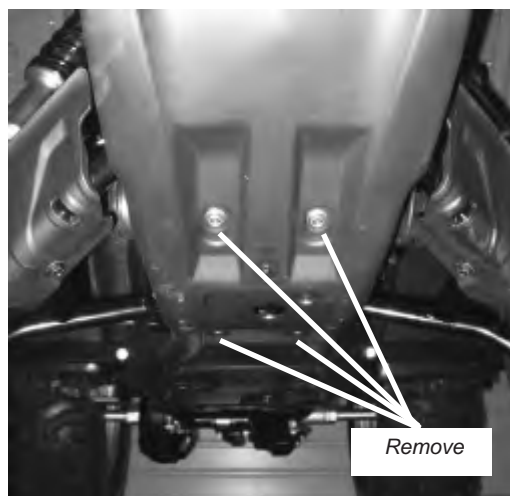

Figure 3 Front Skid Plate Bolts

4. Remove the two 6mm bolts that attach the front bumper to the plastic headlight assembly, figure 4. Save the fasteners as they will be used to reinstall the front bumper.



Figure 4 Front Bumper Bolts

5. Remove the two top 8mm bumper bolts that attach the front bumper to the front rack, figure 5. Save the fasteners as they will be used to reinstall the front bumper.



Figure 5 Remove Top Bumper Bolts

6. Remove the four remaining bumper bolts that attach the bumper to the vehicle frame, figure 6. Remove the bumper from the vehicle at this time.

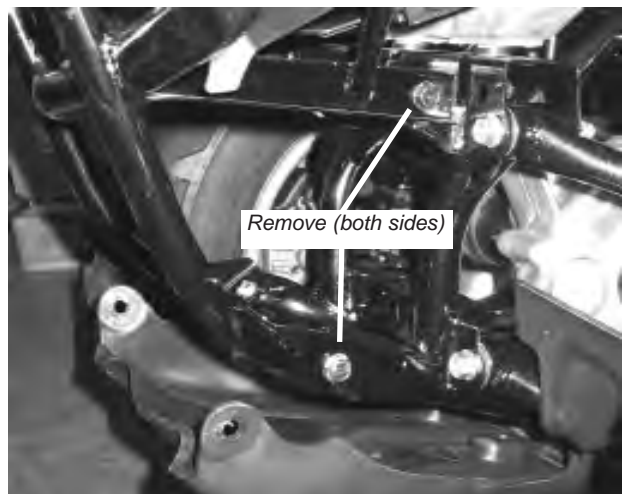

Figure 6 Remove Bumper Bolts

- Depress the side tabs and remove the plastic radiator panel from the vehicle, figure 7. This panel will be reinstalled later.

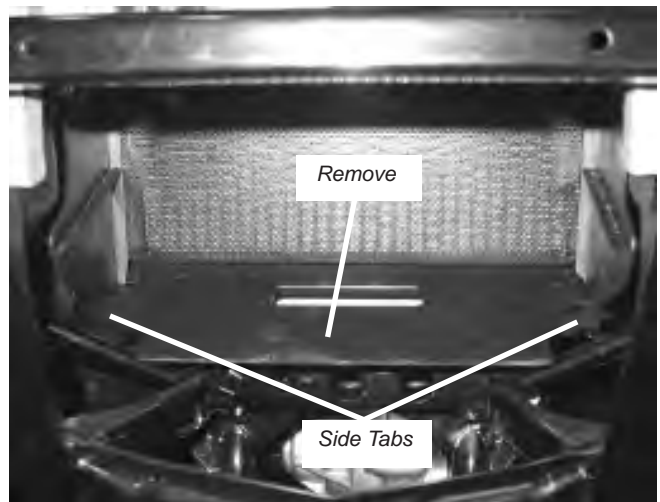

Figure 7 Remove Plastic Radiator Panel

- Attach the winch to the lower mounting bracket (A2), figure 8. Use the two 8mm-1.25 x 20mm bolts and lock washers supplied with the winch, and place a 8mm flat washer (B2) between each lock washer and the lower mounting bracket. Do not tighten the bolts at this time.

*Note: The end loop of the wire rope must be accessible from the top of the drum. If necessary, put the winch in freespool and rotate the drum so that the wire rope end is no longer underneath the bracket.*

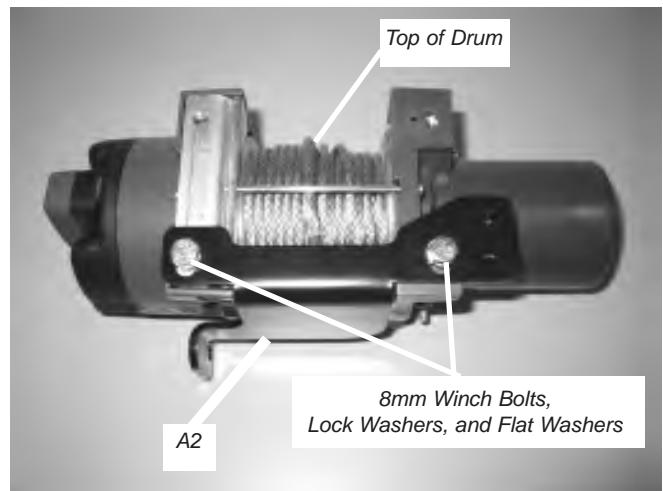

Figure 8 Attach Winch onto Lower Mounting Bracket

- Place the winch and lower mounting bracket assembly into position in the front bumper, figure 9.



Figure 9 Place Winch in Bumper

- Place front bumper and loosely positioned winch assembly back onto the vehicle frame, figure 10. Reinstall the two top bumper bolts that were removed in step 5. Do not tighten at this time.

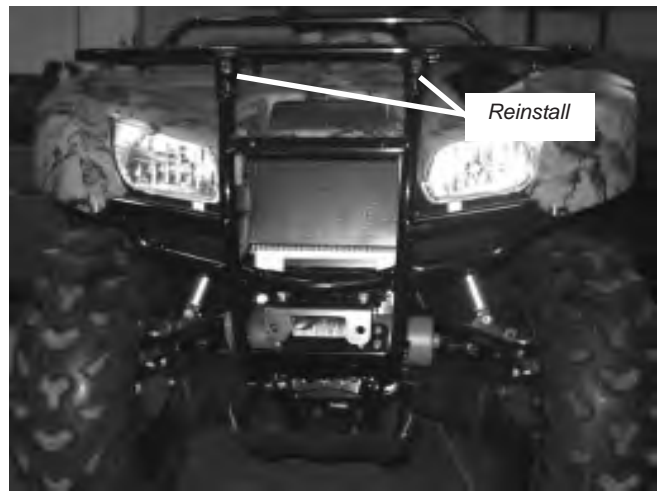

Figure 10 Place Bumper Back onto Vehicle

- Place the upper mounting bracket (A1) onto the vehicle frame, figure 11. Fasten the upper mounting bracket to the winch with two 8mm-1.25 x 20mm bolts and lock washers supplied with the winch. Place a provided 8mm flat washer (B2) between each lock washer and the upper mounting bracket. Do not tighten at this time.
- Route the wire rope between the upper and lower mounting brackets (A1) & (A2), so that the end loop is visible from the front, figure 11.

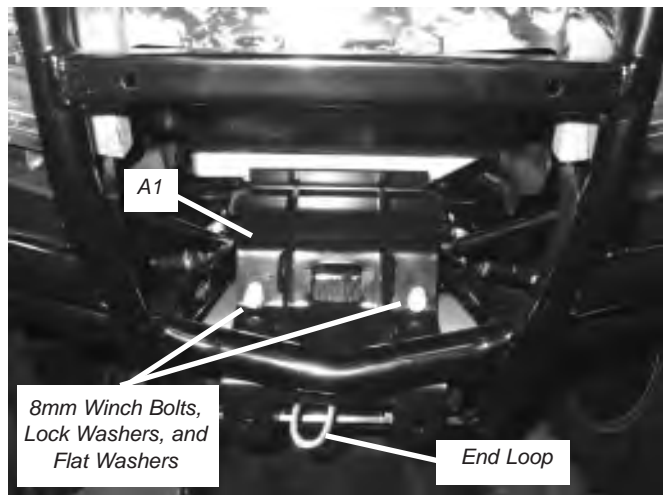

Figure 11 Upper Mounting Bracket Installation

- Install two of the supplied 8mm-1.25 x 30mm bolts (B1) and flat washers (B2) into the middle bumper mounting location. Place the supplied spacer (B3) into position between the ATV frame and the winch mounting bracket tab, figure 12. Do not tighten at this time.

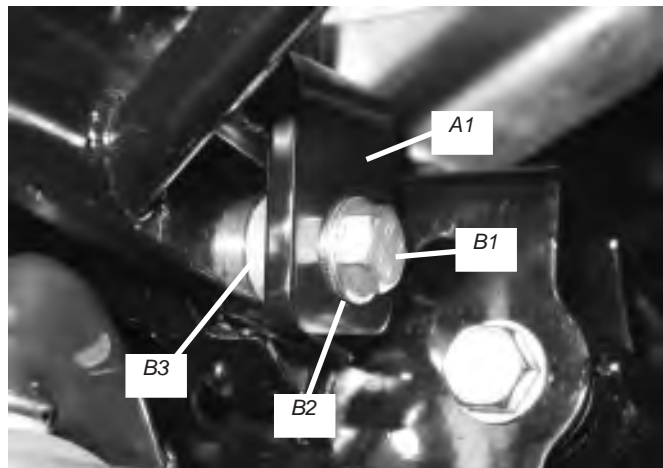

Figure 12 Bolt and Spacer Location

14. Install the supplied 8mm-1.25 x 30mm bolt (B1) and flat washer (B2) into the lower bumper mounting location. Make sure that the bolt passes through the hole on the lower mounting bracket (A2), figure 13. Place the supplied 8mm lock nut (B6) on the end of the 8mm bolt (B1). Do not tighten at this time.

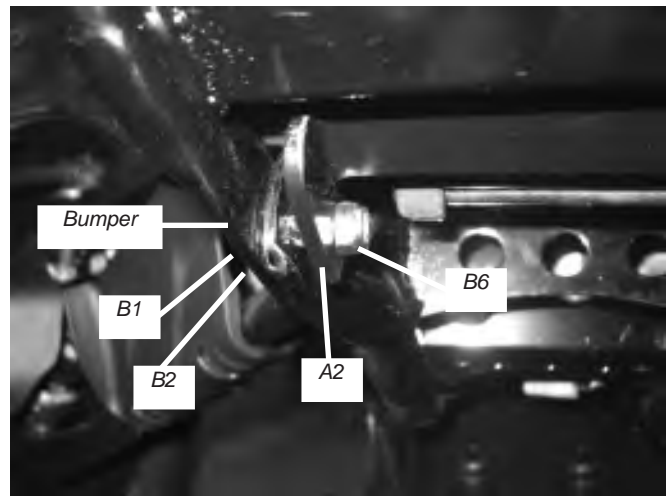

Figure 13 Lower Bumper Mounting Location

15. Place the side mounting bracket (A3) onto the bottom mounting bracket (A2) and install the two supplied 6mm-1.00 x 12mm bolts (B4), figure 14. Place the 6.3mm spacer (B5) between the side mounting bracket and the bumper. Fasten the supplied 8mm-1.25 x 30mm bolt (B1) through the flat washer (B2), side mounting bracket, spacer (B5), bumper, and into the frame, figure 14 and figure 17. Do not tighten at this time.

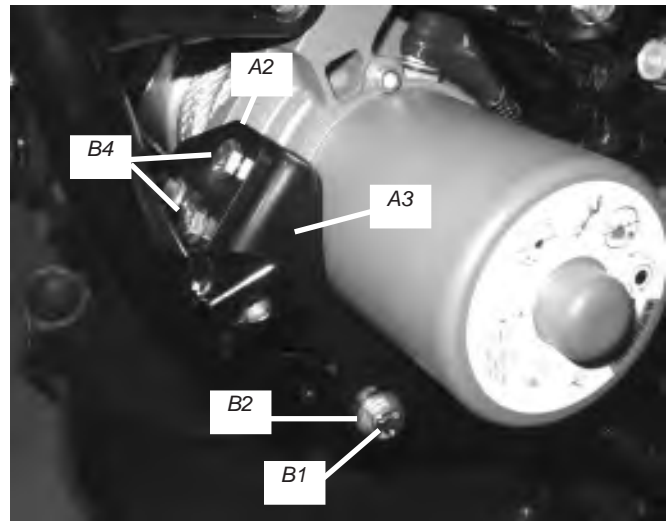

Figure 14 Completed Winch Installation

**⚠ WARNING**

The 6.3mm (1/4") spacer must be used to install the side mounting bracket to the vehicle frame. Failure to do so can result in product failure which can lead to vehicle damage and operator injury or death.

16. Place the motor terminal boots on the supplied yellow and blue electrical cables. Connect the yellow and blue cables to the motor terminals on the winch, figure 15. Tighten the motor terminal nuts to the recommended torque of 5.7 N-m (50 lb-in). Slide the motor terminal boots over the motor terminals.

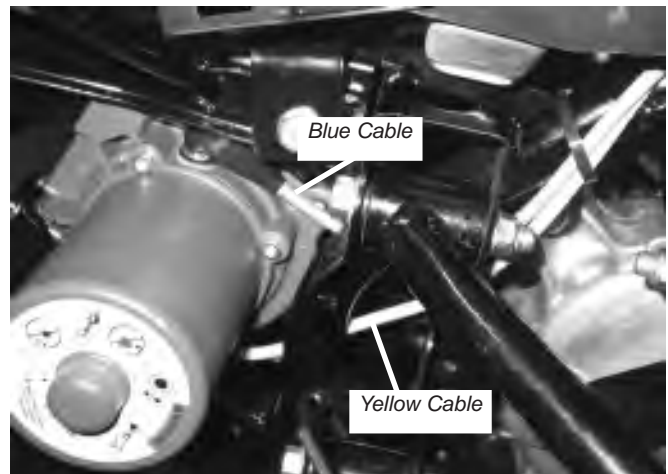

Figure 15 Connect Yellow and Blue Electrical Cables



17. Position the winch on the brackets to maximize the clearance between the motor terminals and the adjacent bumper or frame members, figure 16 and figure 17.

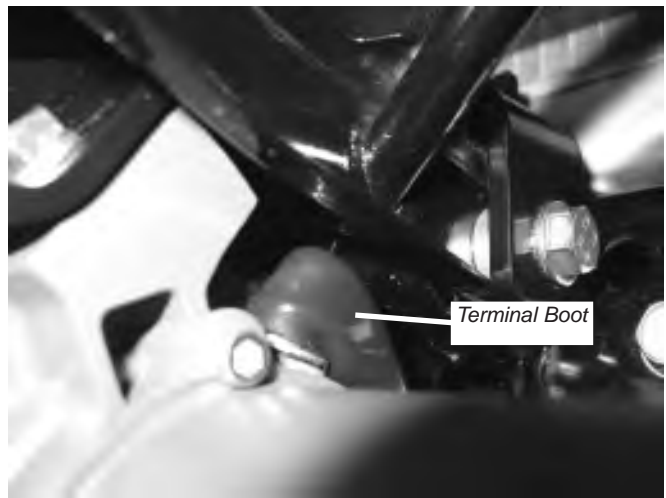

Figure 16 Upper Motor Terminal Clearance

<b>⚠ WARNING</b>
<p>Winch must be positioned such that no fasteners, frame members, or other objects may come in contact with the motor terminals and motor terminal boots. Failure to do so can result in product failure which can lead to vehicle damage and operator injury or death.</p>

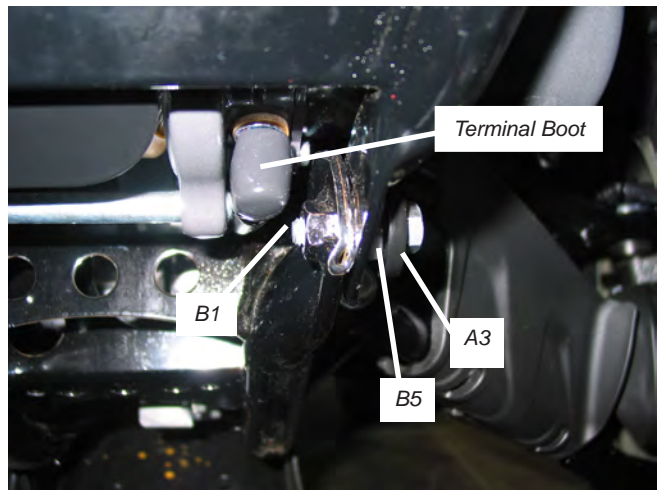

Figure 17 Lower Motor Terminal Clearance

18. Tighten the four winch bolts to a recommended torque of 17 N-m (12 ft-lb), figure 18. Remove the small tie bolt. This bolt should be retained for winch service. Reinstall the two 6mm bolts removed in step 4. Tighten the six 8mm bumper bolts, and the four 6mm bolts to a recommended torque of:

- |           |                     |
|-----------|---------------------|
| 6mm bolts | - 12 N-m (9 ft-lb)  |
| 8mm bolts | - 37 N-m (27 ft-lb) |

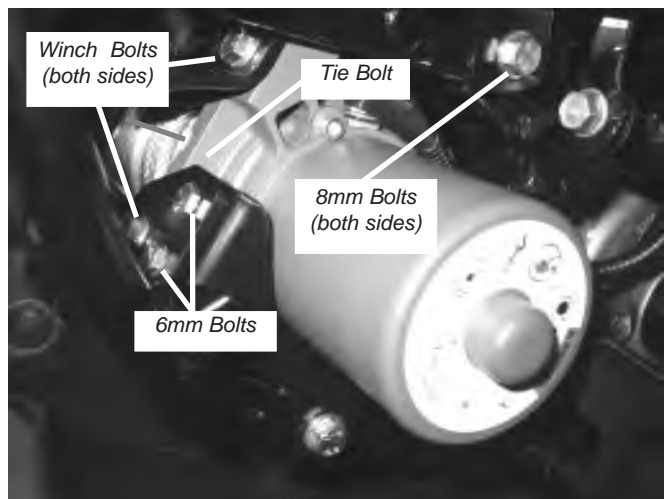

Figure 18 Winch and Mount Bolts

19. Trim the plastic skid plate for winch clutch dial clearance, figure 19. Skid plate should not touch the dial when the 6mm mount bolt is installed.

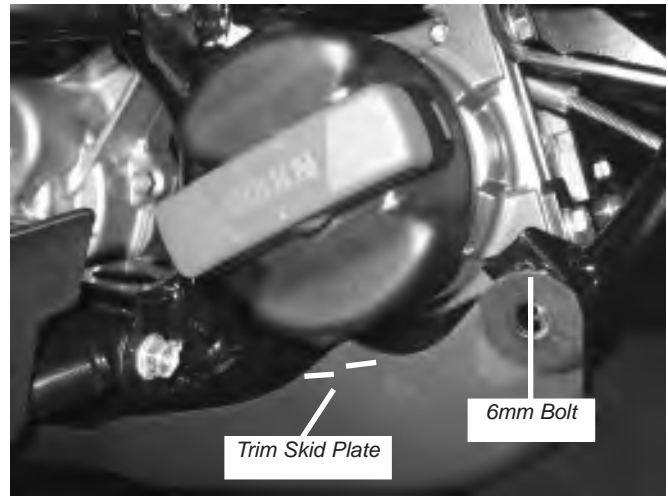

Figure 19 Skid Plate Trim Location

20. Install the roller fairlead using the two 10mm bolts, lock washers, and nuts supplied with the winch, figure 20.

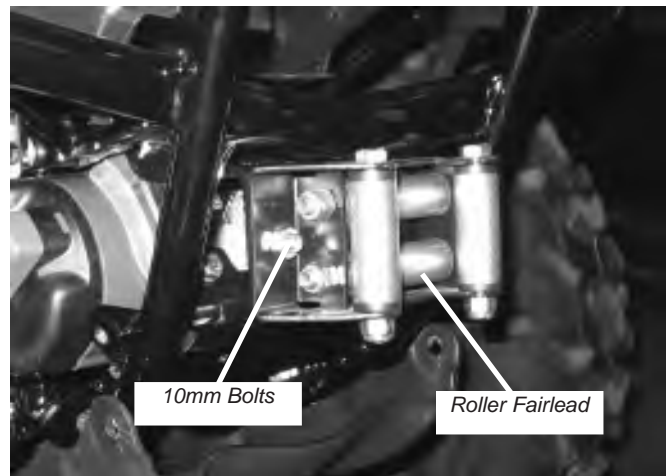

Figure 20 Roller Fairlead Installation

21. Reinstall the plastic radiator panel removed in step 7. Move the front plastic fascia into position over the roller fairlead, figure 21. Reinstall the two side 6mm bolts removed in step 2 and the four 6mm skid plate bolts removed in step 3. Tighten the 6mm bolts to a recommended torque of 12 N-m (9 ft-lb). Reinstall the two plastic rivets removed in step 1.



Figure 21 Front Fascia Reinstalled

22. Switch the winch clutch to freespool. Manually feed the winch cable through the roller fairlead. Attach the clevis hook, supplied with the winch, to the end cable loop as shown in figure 23. This is done by placing the winch wire loop between clevis pin tabs on hook. Insert clevis pin through clevis pin tabs and the winch wire loop. Insert cotter pin into clevis pin retaining hole, figure 22 and figure 23.

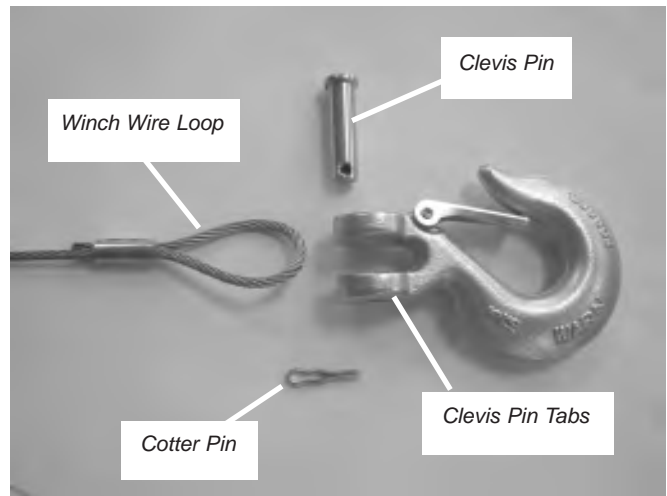

Figure 22 Hook Assembly - Exploded View

23. Complete the winch installation as described in the winch installation and specification guide that came with the winch.

 <b>WARNING</b>
<b>Tighten all nuts and bolts securely. Failure to check all nuts and bolts prior to use can result in product failure which can lead to vehicle damage and operator injury or death.</b>



Figure 23 Hook Assembly - Assembled

Winch and winch mount installation is now complete and should look like figure 24. Proceed to section IV, entitled “Winch Wiring”.



Figure 24 Winch and Mount Installed

## IV. Winch Wiring

### **Notice**

Please refer to the Installation and Specification Guide, supplied in the winch kit, for all wiring schematics and specific details on how to wire the winch to the ATV.

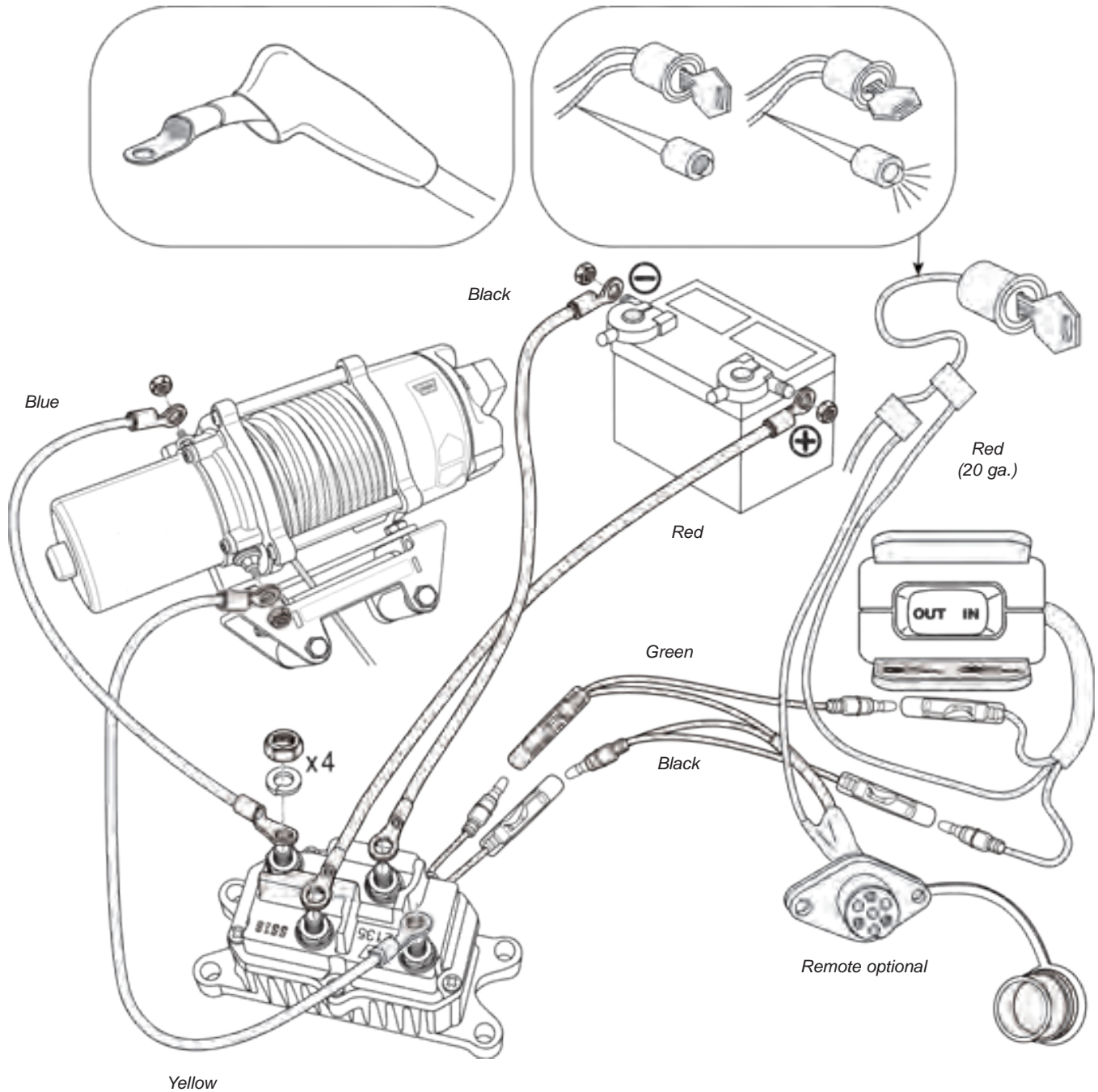

Figure 25 Universal Wiring Installation diagram

## V. TRX420 Specific Wiring Instructions

### Notice

It should be noted that the following instructions are ATV specific only. The following instructions should be referred to as reference instructions to assist wiring the winch from the Installation and Specification Guide supplied in the winch kit.

#### 1. Contactor Location - Step Four in the Installation and Specification Guide:

- The contactor is located under the panel behind the seat, figure 26.
- Remove the seat and the plastic panel covering the battery.
- Position the contactor with the yellow and red terminals closest to the battery, figure 26. Fasten the contactor to the frame tube using the supplied 1/4-20 x 1" x 1 3/4" u-bolts, 1/4" flat washers, and 1/4-20 lock nuts. Do not tighten at this time.

### Notice

Please note that all wires in the wiring photographs are shown without conduit on the colored wires. This is for clarity in the instructions.

#### 2. Handlebar Switch Installation - Step Three in the Installation and Specification Guide:

- Before installing the winch switch, route the red wire towards the switch case. Secure with electrical tape a distance of approximately 25cm (10in) from where the red wire protrudes from the back casing towards the switch case, figure 27. This will allow you to see the red wire when routing the switch wires, down the steering column, to the contactor.
- Mount the winch switch in the location shown in figure 28. The recommended location is on the bottom of the left side of the handlebars.

### Notice

Please refer to the Installation and Specification Guide, supplied in the winch kit, for specific details on how to install the switch onto the ATV. Please note that the switch extension brackets are not used in the TRX420 application.

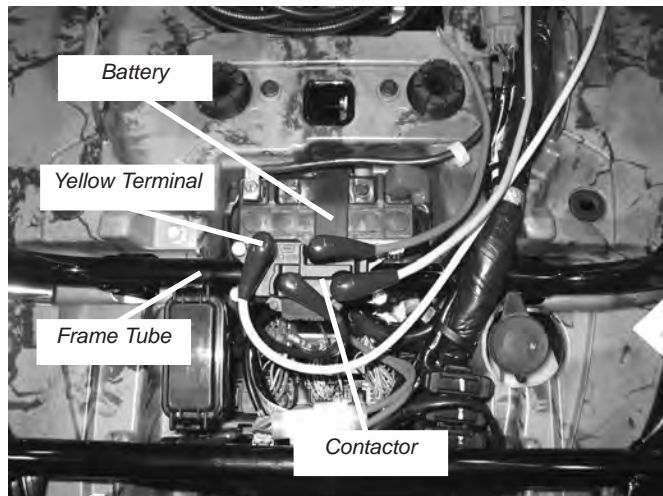

Figure 26 Contactor Location

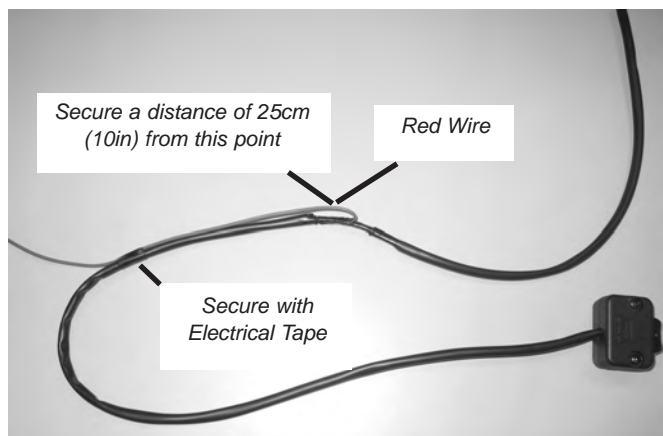

Figure 27 Red Wire - Tie-off 25cm (10in)

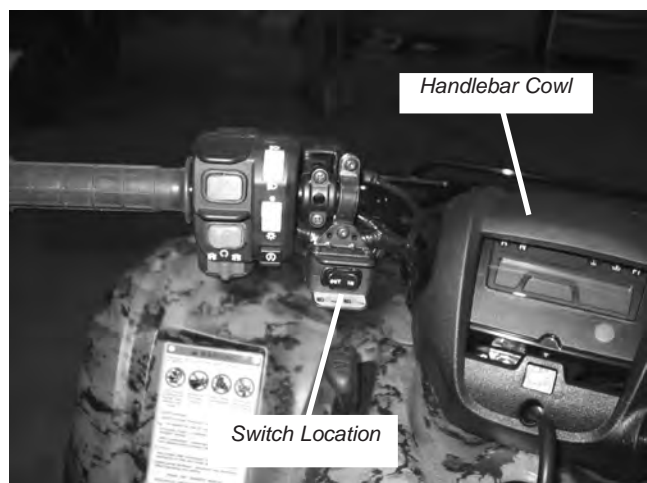

Figure 28 Handlebar Switch Location

c. Remove the handlebar cowl to expose the ignition switch wire harness, refer to the Honda service manual for model specific instructions. Route the handlebar winch switch wire down the handle bar, figure 29. Use existing and supplied plastic tie straps to secure handlebar switch leads.

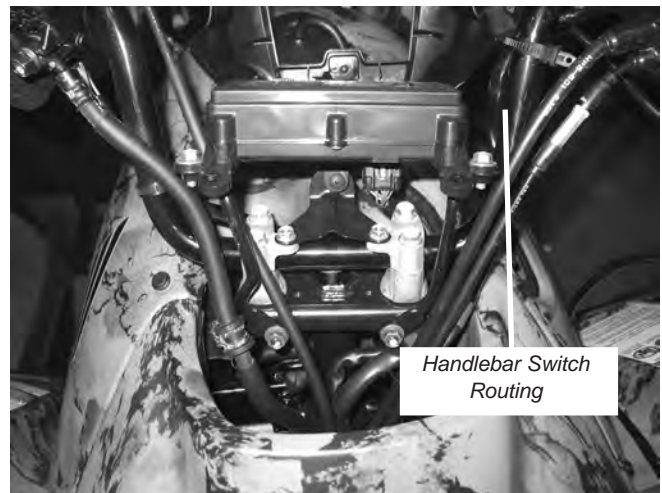

Figure 29 Handlebar Switch Wire Routing

d. Locate the ignition switch wire harness in front of the steering column, figure 30. Cut back the harness protective cover and splice the red switch wire, using the scotch lock supplied in the mounting kit, into the pink wire located in the ignition switch wire harness. Before making the splice, make sure that the pink wire only has power when the key switch is on. Trim the red switch wire excess approximately 20cm (8 in). Retape with electrical tape.

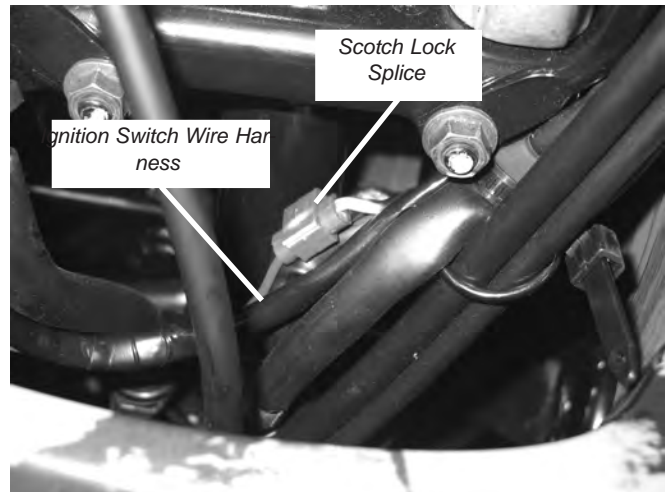

Figure 30 Connecting Switch - Red Wire

- e. Reinstall the handlebar cowl. Use the original hardware to reattach the handlebar cowl. Tighten the bolts securely.
- f. Remove the right side panels by removing the fasteners holding them in place. Keep the fasteners for reinstallation.
- g. Route switch leads to the contactor at the rear of the ATV by following the original wiring harnesses along the right side of the frame, figure 31.

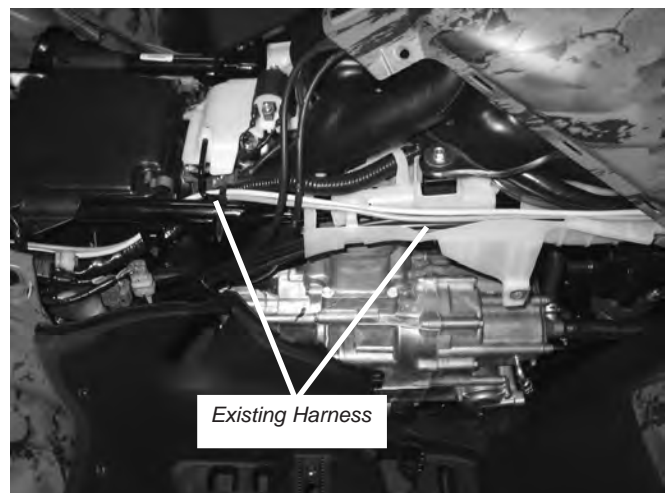

Figure 31 Switch Lead Routing



## WARNING

Avoid all moving and potentially hot components of ATV when routing electrical cables. Avoid areas where the wiring could be pinched when components are reinstalled. Failure to do so can result in product failure which can lead to vehicle damage and operator injury or death.

### 3. Wiring Installation - Step Five in the Installation and Specification Guide:

a. Route the yellow and blue electrical cables from the winch up the left side frame tubes of the ATV, figure 15 and figure 32. Secure the cables with supplied plastic tie straps. Avoid all moving and potentially hot components of the ATV when routing the electrical cables.

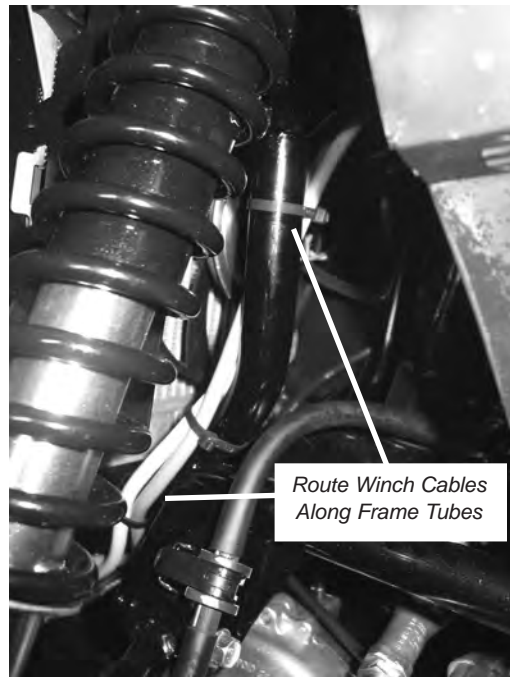

Figure 32 Winch Cables Routing

b. Route the winch wires (yellow and blue) from the left side of the ATV across to the right passing in front of the steering column and following the existing wiring harnesses. Complete the cable routing by following the switch lead path along the right side of the ATV to the contactor, figure 31, figure 33, and figure 34.

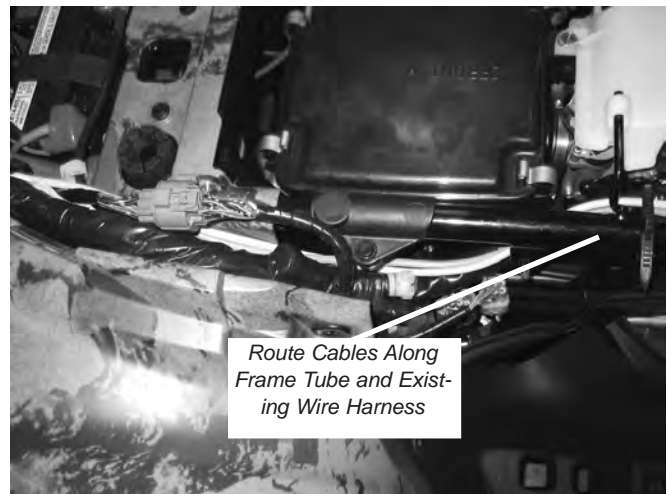

Figure 33 Routing Electrical Cables

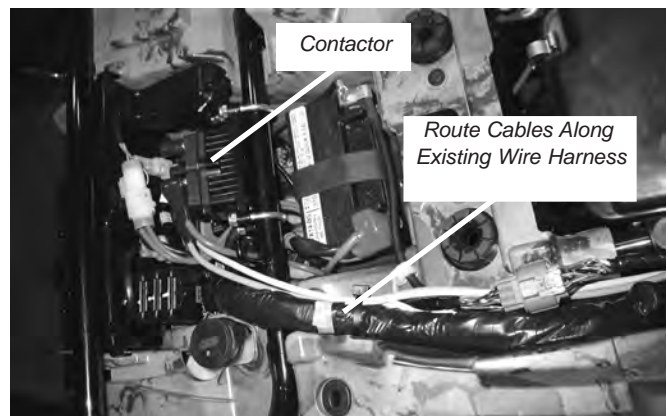

Figure 34 Electrical Cables Routing at Contactor

- c. Place the four remaining cable boots over the four electrical cables. Connect the blue, yellow, red, and black electrical cables to the corresponding contactor terminals, figure 35. Torque the terminal nuts on the contactor to 4.5 N-m (40 in-lb). Do not over tighten. Place the rubber boots into position over the terminals. Connect the green and black switch leads to the contactor at this time.

<b>Notice</b>
Please refer to figure 25 for the wiring schematic

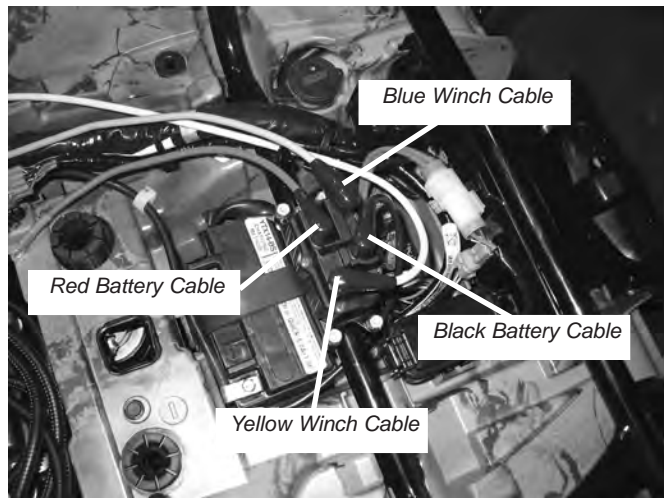

Figure 35 Electrical Cable Connections - Contactor

- d. Route battery electrical cables (red and black) under the frame tube from the contactor to the battery, figure 36. Attach the black wire to the negative terminal on the battery. Attach the red wire to the positive battery terminal. Reposition the protective boot over the positive battery terminal.
- e. Rotate the contactor on the frame tube so that it will not contact the battery cover panel when installed. Tighten the nuts on the u-bolts to a recommended torque of 4.5 N-m (40 in-lb). Do not over tighten.

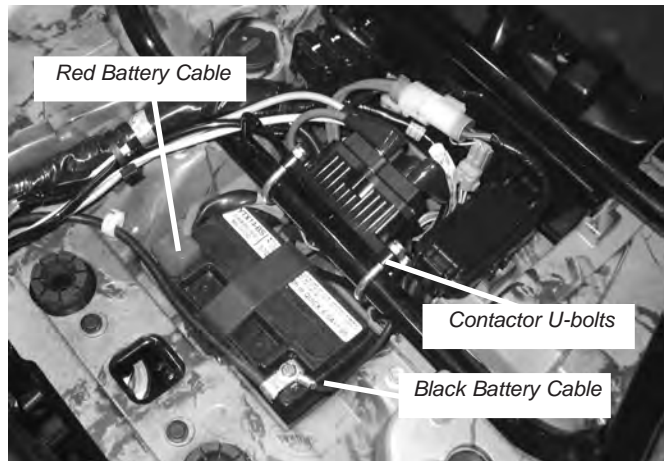

Figure 36 Electrical Connection - Battery Connection

- f. Start at the contactor and use the cable ties supplied in the mounting kit to secure all electrical cables to the ATV frame. Secure any excess wire along the main wire harness at the front of the ATV, figure 37. Avoid all moving and potentially hot components of the ATV when routing the electrical cables. Avoid areas where the wiring could be pinched when components are reinstalled (such as the seat or side panels).

 <b>WARNING</b>
<b>Avoid all moving and potentially hot components of ATV when routing electrical cables. Avoid areas where the wiring could be pinched when components are reinstalled. Failure to do so can result in product failure which can lead to vehicle damage and operator injury or death.</b>



Figure 37 Main Wire Harness - Right Front Wheel Opening



## VI. Maintenance/Care

- Inspect all metal parts on the winch, winch mount, and related hardware. Replace all that appears rusted, cracked or deformed prior to use.
- Inspect all nuts and bolts on the winch, winch mount, and related hardware prior to each use. Tighten all nuts and bolts that are loose. Missing, stripped, fractured, or bent bolts or nuts need to be replaced immediately.
- Check all cables prior to use. Replace cables that are worn or frayed.
- Check all moving and rotating parts. Remove debris that may inhibit the part from moving freely.



### **WARNING**

**Failure to perform regular inspections and maintenance on the winch, winch mount, and related hardware may result in vehicle damage and operator injury or death.**