



The Basic Guide to Utility Winching



Every winching situation has the potential for personal injury. In order to minimize that risk, it is important that you read this Basic Guide carefully, familiarize yourself with the operation of your winch before having to use it, and be constantly safety oriented. In this Guide, we will set forth many of the basic rules of safe winch operation. However, because every winching situation is different, your constant good judgment and consistent focus on safety are of great importance.

Warnings and Cautions



As you read these instructions, you will see WARNINGS, CAUTIONS, NOTICES and NOTES. Each message has a specific purpose. WARNINGS are safety messages that indicate a potentially hazardous situation, which, if not avoided could result in serious injury or death. CAUTIONS are safety messages that indicate a potentially hazardous situation which, if not avoided, could result in minor or moderate injury. A CAUTION may also be used to alert against unsafe practice. CAUTIONS and WARNINGS identify the hazard, indicate how to avoid the hazard, and advise of the probable consequence of not avoiding the hazard. NOTICES are messages to avoid property damage. NOTES are additional information to help you complete a procedure. **PLEASE WORK SAFELY!**

 WARNING		
		
<p>MOVING PARTS ENTANGLEMENT HAZARD</p> <p>Failure to observe these instructions could lead to severe injury or death.</p> <p>To avoid injury to hands or fingers:</p> <ul style="list-style-type: none"> • Always keep hands clear of rope, hook loop, hook and fairlead opening during installation, operation and when spooling in or out. • Always use extreme caution when handling hook and rope during spooling operations. • Always use supplied hook strap whenever spooling rope in or out, during installation, and during operation. • Always wear heavy leather gloves when handling rope. 		

 WARNING	
	
<p>CHEMICAL AND FIRE HAZARD</p> <p>Failure to observe these instructions could lead to severe injury or death.</p> <ul style="list-style-type: none"> • Never route electrical cables: <ul style="list-style-type: none"> - Across any sharp edges. - Through or near moving parts. - Near parts that become hot. • Never operate winch in an environment containing explosive or combustible material. 	

 WARNING	
	
<p>FALLING OR CRUSHING HAZARD</p> <p>Failure to observe these instructions could lead to severe injury or death.</p> <ul style="list-style-type: none"> • Never use winch to lift or move persons. • Never use winch as a hoist or to suspend a load. • Never operate winch with less than 5 wraps of rope around the drum. Rope could come loose from the drum, as the rope attachment to the drum is not designed to hold a load. 	

 WARNING	
	
<p>CUT AND BURN HAZARD</p> <p>Failure to observe these instructions could lead to minor or moderate injury.</p> <p>To avoid injury to hands and fingers:</p> <ul style="list-style-type: none"> • Always wear heavy leather gloves when handling a rope. • Never let rope slip through your hands. • Always be aware of possible hot surface at winch motor, drum or rope during or after winch use. 	

 WARNING
<p>MOVING PARTS ENTANGLEMENT HAZARD</p> <p>Failure to observe these instructions could lead to minor or moderate injury.</p> <p>General Safety:</p> <ul style="list-style-type: none"> • Always know your winch. Take time to fully read the Installation Guide and the Basic Guide to Winching Techniques in order to understand your winch and its operation. • Never operate this winch if you are under 16 years of age. • Never operate this winch when under the influence of drugs, alcohol or medication. • Never exceed winch or rope capacity listed on product data sheet. Double line using a snatch block to reduce winch load. • Always remove jewelry and wear eye protection. <p>Installation Safety:</p> <ul style="list-style-type: none"> • Always choose a mounting location that is sufficiently strong to withstand the maximum pulling capacity of your winch. • Always use factory approved mounting hardware, components, and accessories. • Always use grade 5 (grade 8.8 metric) or better mounting hardware. • Always power winch with only the recommended electrical system voltage. See the winch specification sheet for details. • Never weld mounting bolts. • Always position fairlead with WARNING label on top. • Always spool the rope onto the drum in the direction specified by the winch warning label on the winch and/or documentation. This is required for the automatic brake (if so equipped) to function properly. • Always tightly wind rope onto drum when new and new and after each use. During power in or power out, rope direction can unexpectedly switch if rope is caught in layers on drum. Tightly wound rope reduces chance of catching.

 WARNING
<p>MOVING PARTS ENTANGLEMENT HAZARD</p> <p>Failure to observe these instructions could lead to minor or moderate injury.</p> <p>Winching Safety:</p> <ul style="list-style-type: none"> • Always inspect, rope, hook, and slings before operating winch. Frayed, kinked or damaged rope must be replaced immediately. Damaged components must be replaced before operation. Protect parts from damage. • Never leave the winch power cord plugged in when installing, freespooling, rigging, or when the winch is not being used. • Never hook rope back onto itself. This damages the rope. • Always use a choker chain, choker rope, or strap. • Always remove any element or obstacle that may interfere with safe operation of the winch. • Always take time to use appropriate rigging techniques for a winch pull. • Always be certain the anchor you select will withstand the load and the strap or chain will not slip. • Always select an anchor point as far away as possible. This will provide the winch with its greatest pulling power. • Never touch rope or hook while in tension or under load. • Always stand clear of rope and load and keep others away while winching. • Always be aware of stability of vehicle and load during winching, keep others away. Alert all bystanders of any unstable condition. • Never use winch to secure a load. • Always keep wired remote pendant control lead and power cord clear of the drum, rope and rigging. Inspect for cracks, pinches, frayed wires or loose connections. Damaged components must be replaced before operation. • Never leave remote pendant control where it can be activated during freespooling, rigging, or when the winch is not being used. • Always require operator and bystanders to be aware of rope, vehicle and or load.

WARNING

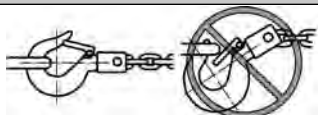

IMPACT AND PART EJECTION HAZARD

Failure to observe these instructions could lead to minor to moderate injury.

- Always use a hook with a latch
- Always ensure hook latch is closed and not supporting load.
- Never apply load to hook tip or latch. Apply load only to the center of hook.
- Never use a hook whose throat opening has increased, or whose tip is bent or twisted.

WARNING

IMPACT AND PART EJECTION HAZARD

Failure to observe these instructions could lead to minor or moderate injury.

To avoid injury to hands and fingers:

- Never engage or disengage clutch if winch is under load, rope is in tension or drum is moving.
- Always ensure the clutch is fully engaged prior to operation of winch.
- Always avoid rapid on/off cycles (jogging or plugging) winch. This can damage motor controls and rope.
- Never shock load rope. Shock load can damage, overload and break rope.

WARNING



SHOCK HAZARD

Failure to observe these instructions could lead to severe injury or death.

- Always use properly grounded 120V AC 50/60 Hz single phase receptacle protected by a ground fault circuit interrupter (GFCI).
- Never remove ground pin from plug.
- Never operate this AC product in a wet environment.
- Never route electrical cables across sharp edges.
- Never route electrical cables through or near moving parts.
- Never route electrical cables near parts that become hot.
- Never remove electrical cover. No user serviceable parts inside. Refer servicing to qualified service personnel.
- Never leave the winch power cord plugged in when installing, freespooling, rigging, servicing or when the winch is not being used.

NOTICE

AVOID WINCH AND EQUIPMENT DAMAGE

- Always avoid side pulls which can pile up rope at one end of the drum. This can damage rope or winch.
- Always avoid "powering out" for extended distances. This causes excess heat and wear on the winch motor and brake.
- Never use winch to secure a load during transport.
- Never submerge winch in water.
- Always store the winch/remote pendant control in a protected, clean, dry area.
- Always double line when rigging heavy loads. This maximizes pulling power and avoids overloading the winch.

WARNING

Never operate or install a winch without reading or understanding the operator's manual.

So, you have your Warn winch and you're ready to put it to use.

Well, if you're smart enough to go prepared with the best, you're probably smart enough to know that to keep having a great time, you need to fully understand your winch and the winching operation.

That's exactly what this guide intends to do: provide you with a basic understanding of your winch and teach you the basics of proper winching techniques. But before we get started, we must emphasize that the information in this guide is general in nature. Because no two situations are alike, it would be nearly impossible to review them all. We can, however, provide you with the general principles and techniques. Then it is up to you to take the time to analyze the situation and apply the proper technique.

Along with a little common sense, the guidelines laid out in this manual can help you keep winching fun. Just remember to think through each situation before you act.

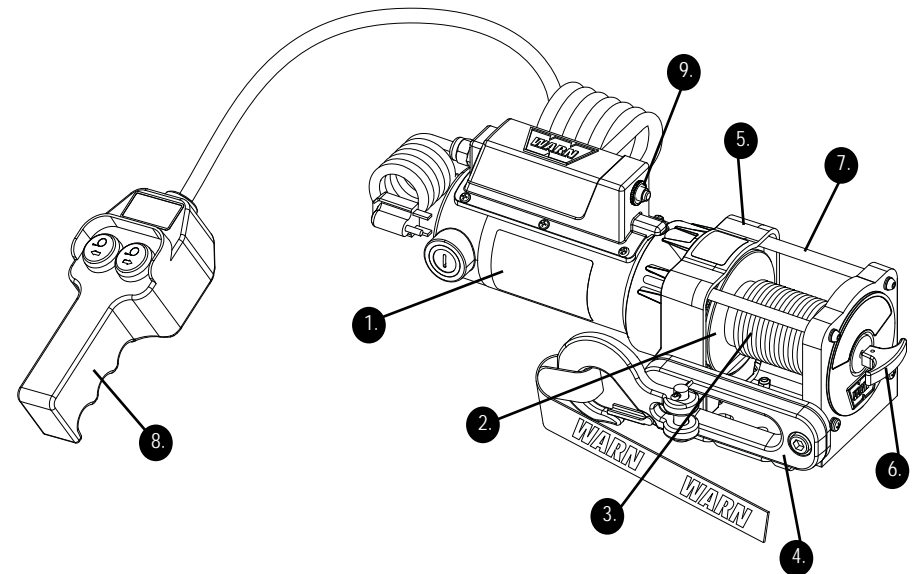

To start, you should familiarize yourself with your Warn winch and each of its components: Practice using your winch before using it for pulling loads.

- 1. Motor** The motor provides torque to the gear train, which turns the winch drum and winds the rope.
- 2. Winch Drum** The winch drum is the cylinder onto which the rope feeds. The drum is driven by the motor and drivetrain. Its direction can be changed using the remote pendant.
- 3. Wire / Synthetic Rope** The rope's diameter and length are determined by the winch's load capacity and design. Wrapped around the winch drum and fed through the fairlead, the rope is looped at the end to accept the hook's clevis pin.
- 4. Fairlead** When using the winch at an angle, the fairlead acts to guide the rope onto the spooling drum. It minimizes damage to the rope while it goes through the winch mount.

- 5. Gear Train** The reduction gear converts the winch motor torque into a large pulling force. The gear train design makes it possible for the winch to be lighter and more compact.
- 6. Clutch** The clutch allows the operator to manually disengage the spooling drum from the gear train, enabling the drum to rotate freely (known as "freespooling"). Engaging the clutch "locks" the winch drum back onto the gear train.
- 7. Tie Rods** Ties the end housings together as a structural unit.
- 8. Remote Pendant** The winch remote pendant enables the operator to start/stop and change the direction of the winch drum rotation.
- 9. Circuit Breaker** Is a device that automatically breaks an electrical circuit whenever the circuit becomes overloaded or an unintentional short circuit occurs.

⚠ CAUTION

Never engage or disengage the clutch if winch is under load, rope is in tension, or rope drum is moving.

⚠ WARNING

Always keep winch and winching load in sight during winching operation.

Winch Mechanics

Now that you've familiarized yourself with your Warn winch and its components, we can begin reviewing how it works. The major advantage of an electric-powered winch is that it can provide reliable service for intermittent utility and recreational use.

It is important to understand that the longer the pull, the more heat that is created, just like a hot plate. Powering out the rope also generates heat. Whenever possible, unwind rope by "freespooling." Prolonged winching without cooling the winch motor will damage the motor.

Control Of Your Winch

The winch is controlled by a remote pendant that provides control of the forward or reverse rotation of the spooling drum.

How the Winch Reacts to Load

Warn winches are rated by pulling capacity. The maximum pulling capacity occurs on the first layer of rope on the drum. As the

layers increase, the pulling power decreases. It's the mathematics of winching. Exceeding the winch capacity could cause the winch to fail or the rope to break. Thinking through how you intend to use your winch now, could save you a big headache later.

In addition, you'll also want to make sure that your winch's mounting system can accommodate the rated load of your winch.

Proper mounting systems are covered in "Installation Instructions".

This winch is controlled by the hand held remote pendant control to allow the operator to stand clear during the winching process.



Alone, the winch is not much more than a simple tool. But when used with certain accessories and enhancements, your Warn winch can become a versatile and productive tool. In this section, we'll review several of these items. Some are vital to the safe operation of your winch, while others offer added versatility and convenience.



Snatch Block: Used properly, the multi-purpose snatch block allows you to: (1) increase your winch's pulling power; and (2) change your pulling direction without damaging the rope. Proper use of the snatch block is covered in "Before You Pull".



Gloves: Rope, through use, will develop "barbs" which can slice skin. It is extremely important to wear protective gloves while operating the winch or handling the rope. Avoid loose fitting clothes or anything that could become entangled in the rope and other moving parts.

Hook Strap: Use to hold the hook and keep fingers away from the fairlead as the rope is being spooled in. Winches develop tremendous pulling forces and can easily remove fingers and limbs that are placed in pinch points. Put the hook into the loop and hold the strap between the thumb and forefingers.



Clevis/D-Shackles: The D-Shackle is a safe means for connecting the looped ends of cables, straps and snatch blocks. The shackle's pin is threaded to allow easy removal.



Choker Chain: Can be used to hook-up a load or anchor winch with accessory mounting plate PN 70770.

Strap: Typically made of tough, high-quality nylon, it provides the operator an attachment method for the winch rope to the load.



WARNING

Never operate winch with less than 5 wraps of rope around the drum. Rope could come loose from the drum, as the rope attachment to the drum, as the rope attachment to the drum is not designed to hold a load.

CAUTION

Never attach a recovery strap to the winch hook to increase the length of a pull. Never attempt to tow a vehicle or object with the recovery strap attached directly to the winch hook. Never use "bungee" straps that develop tremendous and potentially dangerous amounts of force when stretched.

The life of a wire rope is directly related to the use and care it receives. Tensioning the wire rope is critical to ensure a long product life. Tensioning the wire rope will prevent outer layers of wire rope from pinching and deforming the inner layers. During its first use, a new wire rope must be spooled onto its drum under a load of at least 500 lbs. (227kgs). Use the following instructions to properly stretch the wire rope onto the winch drum.

1) Choose a **FLAT AND LEVEL** location that is large enough to run out the entire length of wire rope.

2) Turn the clutch lever on the winch to the "Free Spool" position. Grab hook strap and spool out the wire rope to the last 5 wraps on the drum. Once the wire rope is spooled out, turn the clutch lever on the winch to the "Engaged" position.

3) Attach the hook end of the rope to a suitable load of approximately 500 lbs. (227 kgs). Load should be located so that there is very little slack in the wire rope.

4) Power in the winch until all of the wire rope slack is wound onto the winch drum. Wearing gloves, hold tension on the wire rope with one hand; carefully push the wire rope to the side of the drum the wire rope is attached to so there are no gaps between each coil on the drum. Be sure to check that the wire rope is winding off the bottom of the drum, not the top. If the wire rope is winding off the top you have powered the winch "out" instead of "in".

5) Use care to evenly wrap each layer to prevent damage to the rope.

6) Press power in on the remote pendant control. Make sure wire rope is winding correctly by watching it move across the fairlead as the wire rope is powered in. After winching in for approximately 6 ft, stop winching. Inspect the winch to make sure that the wire rope is being evenly wound onto the winch drum and not sinking into the lower layer. If the wire rope is sinking, power the wire rope out and repeat this step from the beginning with more winching load.

7) When you are convinced the wire rope is winding onto the winch drum properly, repeat step 5 until the load is within 3 ft of the winch. Once within 3 ft, stop winching and remove tension in wire rope. This will ensure that there is no load on the winch wire rope. Disconnect the hook from the load. While holding onto the supplied hook strap, hold tension on the winch rope and slowly power in the winch by "pulsing" the power in on the remote pendant control until the hook is at the fairlead. **DO NOT POWER THE HOOK INTO THE FAIRLEAD.** This could cause damage to the fairlead.

BEFORE YOU PULL

Practice using your winch before you winch a load. A real situation is no time to be learning how to use your winch.

Knowing the proper winching techniques can help keep you and others around you safe. And perhaps the most important part of the winching process, regardless of the situation, is what you do before you pull. In this section, we'll show you the basic fundamentals for effective winching. However, it is up to you to analyze the situation and make the decisions necessary for the proper use of your winch. Apply your knowledge of your winch and the basic fundamentals you've practiced and adjust your techniques to your unique situation. Some keys to remember when using your Warn winch:

1. Always take your time to assess your situation and plan your pull carefully.
2. Always take your time when using a winch.
3. Use the right equipment for your situation.
4. Always wear leather gloves and do not allow the rope to slide through your hands.
5. You and only you should handle the rope and operate the remote pendant control switch.
6. Think safety at all times.
7. Practice. Practice and practice the steps.

Rigging for the Pull

The following steps describe how to winch a load with rigging a single line pull. Double or multiple line rigging techniques follow the same basic steps, but use a snatch block to assist the process.

Step 1: PUT ON GLOVES.



WARNING
Never use the winch as a hoist.

WARNING
Always use supplied hook strap to hold hook when spooling rope in or out.

Step 2: DISENGAGE CLUTCH.

To allow free spooling of the winch drum, rotate the clutch lever on the winch to Disengage.

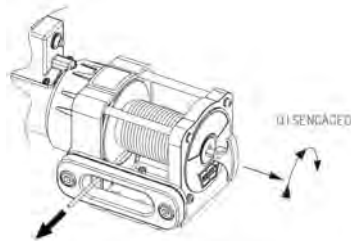

CAUTION
Never attempt to disengage the clutch while rope is under tension. Never engage the clutch while the drum is rotating. Always make sure the clutch is fully engaged or disengaged.

Step 3: FREE THE WINCH HOOK AND ATTACH HOOK STRAP.

Free the winch hook from the load. Attach hook strap to the hook (if not attached).

WARNING
Always keep hands and clothing clear of the rope, hook and fairlead opening during operation and when spooling.

Step 4: PULL ROPE TO LOAD.

Pull out enough rope to reach your load. Be sure to keep a certain amount of tension in the wire. It can become twisted and overwrap when slackened, leading to rope damage. To prevent losing the end, hold the winch hook in the hook strap while you work.

Step 5: SECURE TO THE LOAD.



Once you've established your load point, secure the strap or choker chain around the object/or load.

Step 6: ATTACH THE CLEVIS/D-SHACKLE AND HOOK STRAP.

Attach the shackle to the two ends of the strap or chain and through the hook loop, being careful not to over tighten (tighten and back-off 1/2 turn).

CAUTION
Never attempt to disengage the clutch while rope is under tension. Never engage the clutch while the drum is rotating. Always make sure the clutch is fully engaged or disengaged.

WARNING
Never operate winch with less than 5 wraps of rope around the drum. Rope could come loose from the drum, as the rope attachment to the drum is not designed to hold a load.

CAUTION
Never leave the winch power cord plugged in when installing, free-spooling, rigging, servicing or when the winch is not in use.

WARNING
Never hook rope back onto itself. This damages the rope.



BEFORE YOU PULL

Step 7: LOCK THE CLUTCH.

Lock the winch drum by rotating the clutch lever on the winch to Engage.

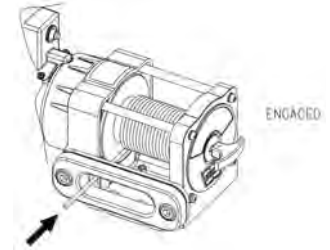

Step 8: PLUG IN THE WINCH POWER CORD.

Be careful not to let the power cord or remote pendant control cord dangle in front of the winch. Always disconnect the winch power cord when not in use.

Step 9: PUT ROPE UNDER TENSION.

Using the winch remote pendant, slowly wind the rope until no slack remains. Once the rope is under tension, stand well clear, and never step over it.

Step 10: CHECK YOUR LOAD.

Make sure all connections are secured and free of debris before continuing with the winching procedure.

As you probably have already noticed, there are many things to do and consider before you actually begin pulling. Think through what you're doing and you can keep yourself and those around you out of harm's way.

Operating your winch properly is so important, in fact, you should practice these techniques before having to face the distractions and stresses of a real winching situation.

Step 11: CHECK ROPE. The rope should be neatly wound around the spooling drum. Improper winding can cause damage to the rope.

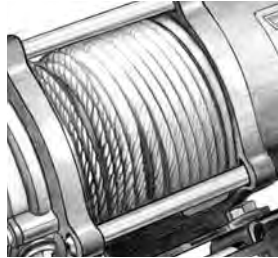

CAUTION
Never use the winch as a hoist

Step 12: LAY SOMETHING OVER THE ROPE, if you decide it is necessary, midway between the winch and the load point to absorb energy should the rope snap loose. Heavy blankets, heavy jackets, chain and a back pack may be used for this purpose.



NOTICE
Avoid over heating the winch motor. For extended winching, stop at reasonable intervals to allow the winch motor to cool down. See table for run time guidelines

Establish "no people" zones

NOTICE
Never use the winch's rope to tow another vehicle or object. Impact loading during towing can exceed rope strength.

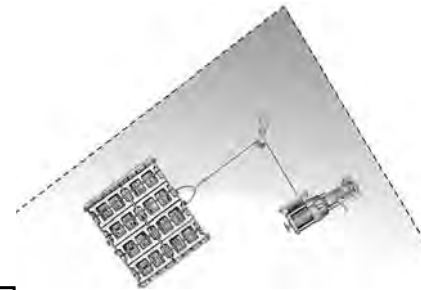
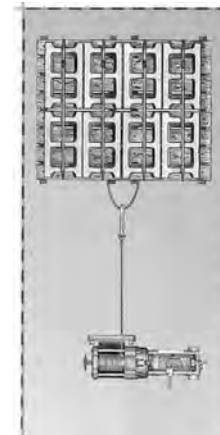

NOTICE
Always avoid continuous side pulls which can pile up rope at one end of the drum. This can damage rope or winch.

Step 13: MAKE YOUR INTENTIONS CLEAR. Be sure that everyone in the immediate vicinity surrounding the winching operation is completely aware of your intentions before you pull.

Declare where the spectators should not stand — never behind or in front of the vehicle and never near the rope or snatch block. Your situation may have other "no people" zones.

What to look for under load
The rope must always spool onto the drum on the side nearest the mounting plate as indicated by the warning label on the winch.
As you power in, make sure the rope winds evenly and tightly on the drum. This prevents the outer wire wraps from drawing into the inner wraps, binding and damaging the rope.
During side pulls the rope tends to stack up at one end of the drum. This stack can become large enough to cause serious damage to the winch. So, line up pulls as straight ahead as possible and stop winching if the rope comes close to the tie rods or mounting plate. To fix an uneven stack, spool out that section of the rope and reposition it to the opposite end of the drum which will free up space for continued winching.

Step 14: BEGIN WINCHING. With light tension already on the rope, begin winching slowly and steadily. Be sure that the rope is winding evenly and tightly around the spooling drum.

Step 15: SECURE LOAD. Once recovery of the load is complete, be sure to secure the load completely. Only then should you release tension in the rope.



How to spool under no load

Arrange the rope so it will not kink or tangle when spooled. Be sure any rope already on the spooling drum is wound tightly and evenly layered. Tighten and straighten the layer if necessary. Keep the rope under light tension and spool the rope back onto the winch drum in even layers one layer at a time. At the end of each layer stop spooling and arrange the rope in tight even layers.

Repeat this process until the winch hook is a minimum of 4 ft. (1.2m) from the winch. Pinch the hook between your thumb and forefinger and attach the hook strap. Hold the hook strap between the thumb and forefinger to keep tension on the rope. Walk the rope towards the fairlead, carefully spooling in the remaining rope by pulsing the control switch. Store the hook at the fairlead or tensioned to a suitable location to the side.

If you do not have the hook strap, use a length of cord or something similar. To prevent serious injury, NEVER put your fingers inside the hook area as you are powering in.



Step 17: REWIND ROPE. The person handling the rope should walk the rope, using the hook strap, in and not let it slide through the hand and control the winch at all times.



Step 16: DISCONNECT ROPE.
Disconnect from the load.

Step 18: DISCONNECT THE WINCH POWER CORD.
Disconnect the winch power cord and store the winch in a clean and dry place. Winching operations are now complete.

⚠ WARNING
Always keep hands and clothing clear of the rope, hook and fairlead opening during operation and when spooling.

Various winching situations will require application of other winching techniques. These could range from too little distance to achieve maximum pull using straight line rigging, simply increasing pulling power, or maintaining a straight-line pulling situation. You will have to assess what technique is correct for your situation. Think "safety" at all times.



Increasing pulling power & duration

In some cases, you may find yourself needing more pulling power. The use of snatch blocks increases mechanical advantage and increases your pulling power:

Double line

Because pulling power decreases with the number of layers of rope on the winch drum, you can use a snatch block to double line out more rope. This decreases the number of layers of rope on the drum, and increases pulling power.

Start by feeding out enough rope to free the winch hook. Attach the hook to an anchor and run the rope through a snatch block.

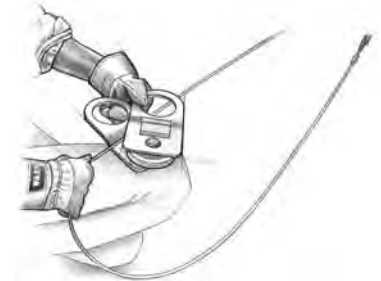
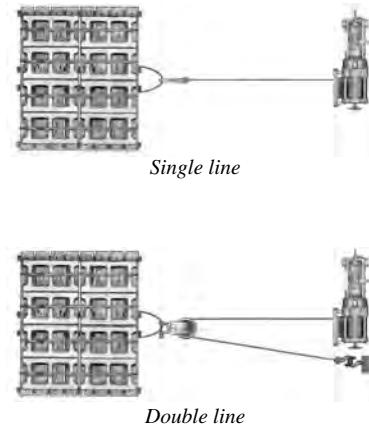

Disengage the clutch and, using the snatch block, pull out enough wire to reach your load point.

Secure to the load point with a strap or choker chain. Attach the clevis/shackle. Attach the shackle to the two ends of the strap/chain, being careful not to over tighten (tighten and back-off 1/2 turn).

Maintenance

Inspect the rope before and after each winching operation. If the rope has become kinked or frayed, the rope needs to be replaced immediately. Be sure to also inspect the winch hook and hook pin for signs of wear or damage. Replace if necessary.

Keep winch, rope, and remote pendant control free from contaminants. Use a clean rag or towel to remove any dirt and debris. If necessary, unwind winch completely (leaving a minimum of 5 wraps on spooling drum), wipe clean, and rewind properly before storage. Using light oil on the wire rope and winch hook can keep rust and corrosion from forming.

Inspect remote pendant control and all electrical connections to be certain they are clean and tight fitting.

Inspect the remote pendant control for damage. Store the winch/remote pendant in a protected, clean, dry area.

No lubrication is required for the life of the winch.

Storage

When not being used, the winch should be left with the clutch in the engaged position. This helps the internal parts of the winch withstand the effects of weather and contamination.

Final Comment

The basic guide to proper winching techniques cannot cover all the possible situations in which you may need to use a winch. In the final analysis, the decisions you make will determine the final outcome. So think through each situation and each step of use. Always be mindful of your own safety and the safety of others. Pay attention and you'll have fun.

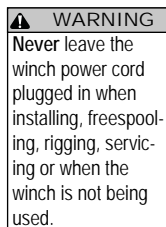

Winch Installation

Choose a mounting location that is sufficiently strong enough to withstand the loads you intend to winch. The mounting platform should withstand 4x the rated load of your winch.

Mounting Location

- 1) Smooth and flat, thickness = 3/16" (5mm)
- 2) Supplied M8 lock washers (Qty. 4)
- 3) Supplied M8 flat washers (Qty. 4)
- 4) Supplied grade 8.8 M8 x 25mm bolts (Qty. 4)
- 5) Torque 17 ft. lbs. (23 Nm)

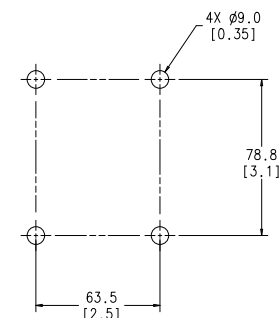

Mounting Bolt Pattern

Operating Instructions

Connect the winch to an AC power source.

- 1) Connect the winch power cord to a properly grounded, 3-prong electrical socket with a Ground Fault Circuit Interrupter (GFCI).
- 2) Verify that all wiring and power supply cords are positioned so that the wire rope or moving load will not damage the cords.
- 3) If using an extension cord and/or generator, make sure that it is rated to handle a minimum of 15 Amps, the current required to run the winch at full capacity.
- 4) Always unplug the winch when not in use.
- 5) Unplug the product when maintaining or cleaning.

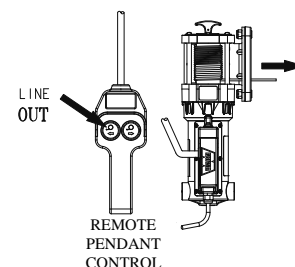
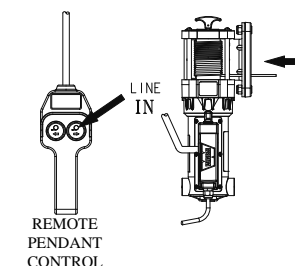

Using the remote pendant control

The remote pendant control is hard wired to the winch and can be operated in the remote position away from the winch unit.

Press the power-out button to spool wire rope off of the drum, or press the power-in button to spool wire rope onto the drum.

WINCH USER GUIDE

Overloading/Overheating

This winch is rated for intermittent duty. It should not be operated with the motor slowed down to a low RPM. When the motor approaches stall speed, a very rapid heat build-up occurs which may cause motor damage.

Overloading/overheating may cause the product circuit breaker to trip. Circuit breaker tripped will be indicated by the center portion protruding from the main body. To reset the circuit breaker, let the winch motor cool and press the center portion back into the circuit breaker body.

Reduce run time and increase cooling if this happens.

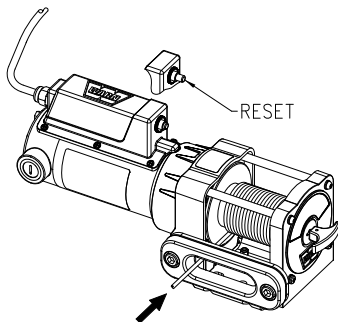

 WARNING	
Always use properly grounded 120V AC 50/60 Hz single phase receptacle protected by a ground fault circuit interrupter (GFCI).	
Never remove ground pin from plug.	
Never operate this AC product in a wet environment.	
Never route electrical cables across sharp edges.	
Never route electrical cables through or near moving parts.	
Never route electrical cables near parts that become hot.	
Never remove electrical cover.	
No user serviceable parts inside. Refer servicing to qualified service personnel.	