





















The Basic Guide to Winching Techniques

Every winching situation has the potential for personal injury. In order to minimize that risk, it is important that you read this Basic Guide carefully, familiarize yourself with the operation of your winch before having to use it, and be constantly safety oriented. In this Guide, we will set forth many of the basic rules of safe winch operation. However, because every winching situation is different, your constant good judgment and consistent focus on safety are of great importance.

TABLE OF CONTENTS:

| | |
|--|-------|
| Symbol Index | 2 |
| General Safety Precautions | 3-5 |
| Winch basics | 6-7 |
| How the winch works | 8 |
| Winch accessories & enhancements | 9-10 |
| Before you pull | 11-14 |
| Pulling | 14-17 |
| Rigging techniques | 18-19 |
| Maintenance | 20 |
| The final analysis | 20 |

| SYMBOL | EXPLANATION |
|---|--|
|  | Read the Instruction Manual |
|  | Always Wear Hearing and Eye Protection |
|  | Never Use Winch as a Hoist |
|  | Properly Seat Load in Throat of Hook |
|  | Wind Rope on Bottom of Drum |
|  | Finger/Fairlead Crushing Hazard |
|  | Hand Piercing/Cutting Hazard |
|  | Explosion/Bursting Hazard |
|  | Sharp Edge Hazard |

| SYMBOL | EXPLANATION |
|---|---------------------------------------|
|  | Always Wear Leather Gloves |
|  | Do Not Move People |
|  | Always Use Supplied Hook Strap |
|  | Never Apply Load to Hook Tip or Latch |
|  | Never Wind Rope Over Top of Drum |
|  | Fairlead Pinch Point |
|  | Hot Surface Hazard |
|  | Fire and Burn Hazard |
|  | Moving Parts Hazard |



Warnings and Cautions



As you read these instructions, you will see WARNINGS, CAUTIONS, NOTICES and NOTES. Each message has a specific purpose. WARNINGS are safety messages that indicate a potentially hazardous situation, which, if not avoided could result in serious injury or death. CAUTIONS are safety messages that indicate a potentially hazardous situation which, if not avoided, could result in minor or moderate injury. A CAUTION may also be used to alert against unsafe practice. CAUTIONS and WARNINGS identify the hazard, indicate how to avoid the hazard, and advise of the probable consequence of not avoiding the hazard. NOTICES are messages to avoid property damage. NOTES are additional information to help you complete a procedure. **PLEASE WORK SAFELY!**

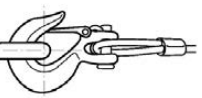

WARNING

MOVING PARTS ENTANGLEMENT HAZARD

Failure to observe these instructions could lead to serious injury or death.

- **Always** ensure hook latch is closed and not supporting load.
- **Never** apply load to hook tip or latch. Apply load only to the center of hook.
- **Never** use a hook whose throat opening has increased, or whose tip is bent or twisted.
- **Always** use a hook with a latch.
- **Always** ensure the operator and bystanders are aware of the stability of the vehicle and/or load.
- **Always** keep wired remote control lead and power cord clear of the drum, rope, and rigging. Inspect for cracks, pinches, frayed wires or loose connections. Damaged components must be replaced before operation.
- **Always** pass remote lead thru window when used in vehicle.



WARNING



MOVING PARTS ENTANGLEMENT HAZARD



Failure to observe these instructions could lead to serious injury or death.



General Safety:

- **Always** Know Your Winch. Take time to fully read the Instructions and/or Operations Guide, and/or Basic Guide to Winching Techniques, in order to understand your winch and its operations.
- **Never** exceed winch or winch rope rated capacity. Double line using a snatch block to reduce winch load.
- **Always** wear heavy leather gloves when handling winch rope.
- **Never** use winch or winch rope for towing. Shock loads can damage, overload and break rope.
- **Never** use a winch to secure a load.
- **Never** operate this winch when under the influence of drugs, alcohol or medication.
- **Never** operate this winch if you are under 16 years of age.





Installation Safety:



- **Always** choose a mounting location that is sufficiently strong to withstand the maximum pulling capacity of your winch.
- **Always** use grade 5 (grade 8.8 metric) or better hardware.
- **Never** weld mounting bolts.
- **Always** use factory approved mounting hardware, components, and accessories.
- **Never** use bolts that are too long.
- **Always** complete the winch installation and hook attachment before installing the wiring.
- **Always** keep hands clear of winch rope, hook loop, hook and fairlead opening during installation, operation, and when spooling in or out.
- **Always** position fairlead with warning readily visible on top.
- **Always** prestretch rope and respool under load before use. Tightly wound rope reduces chances of "binding", which can damage the rope.

|  WARNING | |
|--|---|
|  |  |
| <p>MOVING PARTS ENTANGLEMENT HAZARD Failure to observe these instructions could lead to serious injury or death.</p> <p>Winching Safety:</p> <ul style="list-style-type: none"> • Always inspect winch rope, hook, and slings before operating winch. Frayed, kinked or damaged winch rope must be replaced immediately. Damaged components must be replaced before operation. Protect parts from damage. • Always remove any element or obstacle that may interfere with safe operation of the winch. • Always be certain the anchor you select will withstand the load and the strap or chain will not slip. • Always use supplied hook strap whenever spooling winch rope in or out, during installation and during operation. • Always require operators and bystanders to be aware of vehicle and or load. • Always be aware of stability of vehicle and load during winching, keep others away. Alert all bystanders of an unstable condition. • Always unspool as much wire rope as possible when rigging. Double line or pick distant anchor point. • Always take time to use appropriate rigging techniques for a winch pull. • Never touch winch rope or hook while someone else is at the control switch or during winching operation. • Never engage or disengage clutch if winch is under load, winch rope is in tension or drum is moving. • Never touch winch rope or hook while under tension or under load. • Always stand clear of winch rope and load and keep others away while winching. • Never use vehicle to pull load on winch rope. Combined load or shock load can damage, overload and break rope. • Never wrap winch rope back onto itself. Use a choker chain or tree trunk protector on the anchor. | |

|  WARNING | |
|---|---|
|  |  |
|  |  |
| <p>FALLING OR CRUSHING HAZARD Failure to observe these instructions could lead to serious injury or death.</p> <ul style="list-style-type: none"> • Always stand clear, keep hands clear, keep others away. • Never operate winch with less than 5 wraps of rope around the drum. Rope could come loose from the drum, as the rope attachment to the drum is not designed to hold a load. • Never use winch as a hoist or to suspend a load. • Always be certain anchor will withstand load, use appropriate rigging and take time to rig correctly. • Never use winch to lift or move persons. • Never use excessive effort to freespool winch rope. • Always use proper posture/lifting technique or get lifting assistance while handling and installing product. • Always spool the rope onto the drum in the direction specified by the winch warning label on the winch and/or documentation. This is required for the automatic brake (if so equipped) to function properly. • Always spool the winch rope onto the drum as indicated by the drum rotation label. | |

|  WARNING | |
|---|---|
|  |  |
| <p>CUT AND BURN HAZARD Failure to observe these instructions could lead to serious injury or death.</p> <p>To avoid injury to hands and fingers:</p> <ul style="list-style-type: none"> • Always wear heavy leather gloves when handling winch rope. • Always be aware of possible hot surfaces at winch motor, drum or rope during or after winch use. | |

|  WARNING | |
|---|---|
|  |  |
|  |  |
| <p>CHEMICAL AND FIRE HAZARD Failure to observe these instructions could lead to serious injury or death.</p> <ul style="list-style-type: none"> • Always remove jewelry and wear eye protection. • Never route electrical cables across sharp edges. • Never route electrical cables near parts that get hot. • Never route electrical cables through or near moving parts. • Always place the supplied terminal boots on wires and terminals as directed by the installation instructions. • Never lean over battery while making connections. • Never route electrical cables over battery terminals. • Never short battery terminals with metal objects. • Always verify area is clear of fuel lines, fuel tank, brake lines, electrical wires, etc., when drilling. • Always consult operator's manual for proper wiring details. • Always insulate and protect all exposed wiring and electrical terminals. | |

|  CAUTION | |
|--|---|
|  |  |
| <p>CUT AND BURN HAZARD Failure to observe these instructions could lead to minor or moderate injury.</p> <ul style="list-style-type: none"> • Never let winch rope slip through your hands. | |

|  CAUTION | |
|--|---|
|  |  |
| <p>MOVING PARTS ENTANGLEMENT HAZARD Failure to observe these instructions could lead to minor or moderate injury.</p> <p>To avoid injury to hands or fingers:</p> <ul style="list-style-type: none"> • Never leave remote control where it can be activated during free spooling, rigging, or when the winch is not being used. • Never leave the winch remote control plugged in when installing, freespooling, rigging, servicing or when the winch is not being used. | |

| NOTICE | |
|---|--|
| <p>AVOID WINCH AND EQUIPMENT DAMAGE</p> <ul style="list-style-type: none"> • Always avoid side pulls which can pile up wire rope at one end of the drum. This can damage wire rope or winch. • Always ensure the clutch is fully engaged or disengaged. • Always use care to not damage the vehicle frame when anchoring to a vehicle during a winching operation. • Never submerge winch in water. • Always store the remote control in a protected, clean, dry area. | |

ELECTRIC WINCH BASICS

⚠ WARNING

Always take time to fully understand your winch and the winching operation by reviewing this guide and the Operator's Guide included with your winch..

So, you have your Warn winch and you're ready to get out on the trails: climb a few boulders, splash a little mud, traverse the occasional stream. Basically, you're ready to explore the backcountry and otherwise have a great time.

Well, if you're smart enough to go prepared with the best, you're probably smart enough to know that to keep having a great time, you need to fully understand your winch and the winching operation.

That's exactly what this guide intends to do: provide you with a basic understanding of your winch and teach you the basics of proper winching techniques. But before we get started, we must emphasize that

the information in this guide is general in nature. Because no two situations are alike, it would be nearly impossible to review them all. We can, however, provide you with the general principles and techniques. Then it is up to you to take the time to analyze the situation and apply the proper technique.

Along with a little common sense, the guidelines laid out in this book can help you keep off-roading fun. Just remember to think through each situation before you act and TREAD LIGHTLY!

Structural components of a planetary gear winch

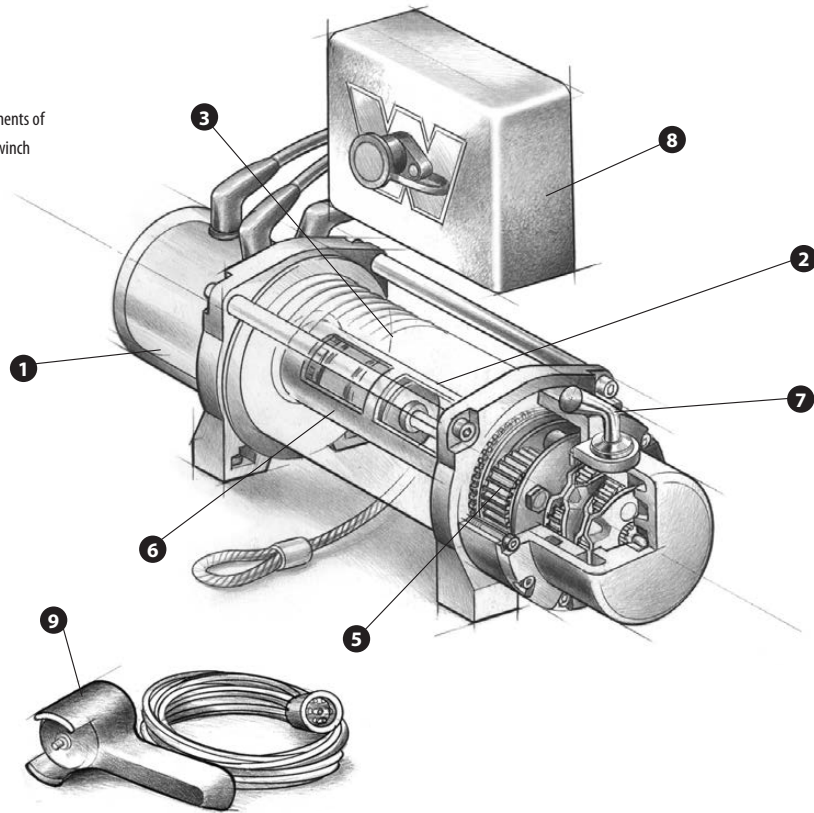

ELECTRIC WINCH BASICS

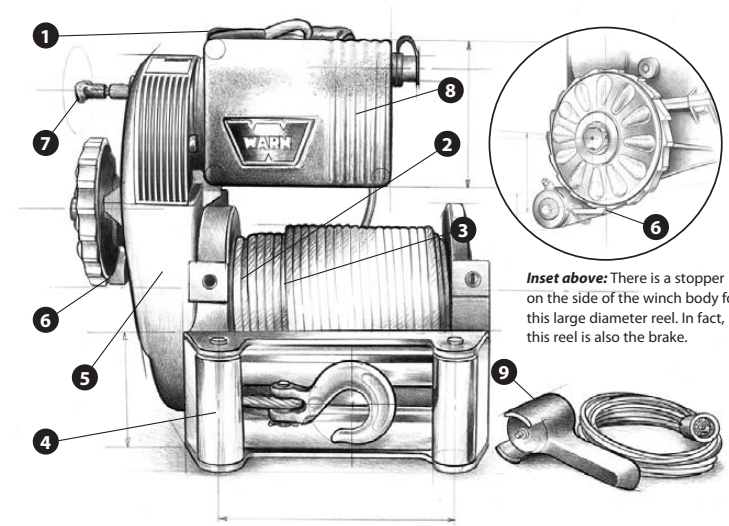

The 8274-50 winch has a different structure. This winch uses spur gears for reduction. Moreover, it has an automatic disc type brake on the body side.

To start, you should familiarize yourself with your Warn winch and each of its components: Practice using your winch before using it on the trail.

1 Motor Typically the winch motor is powered by the vehicle's battery. The motor provides power to the gear mechanism, which turns the winch drum and winds the wire rope.

2 Winch Drum The winch drum is the cylinder onto which the wire rope feeds. The drum is driven by the motor and drive train. Its direction can be changed using the remote control.

3 Wire Rope The wire rope's diameter and length are determined by the winch's load capacity and design. Wrapped around the winch drum and fed through the fairlead, the wire rope is looped at the end to accept the hook's clevis pin.

4 Fairlead When using the winch at an angle, the fairlead (or wire lead) acts to guide the wire rope onto the spooling drum. It minimizes damage to the wire rope while it goes through the winch mount or bumper.

5 Gear Train The reduction gear converts the winch motor power into a large pulling force. The gear train design makes it possible for the winch to be lighter and more compact.

6 Braking System The brake is automatically applied to the winch drum when the winch motor is stopped and there is load on the wire rope. The brake prevents the winch from paying out line, which in turn holds the vehicle in place.

7 Clutch The clutch allows the operator to manually disengage the spooling drum from the gear train, enabling the drum to rotate freely (known as "freespooling"). Engaging the clutch "locks" the winch drum back onto the gear train.

8 Control Box Using electrical power from the vehicle's battery, the control box solenoids switch power to the motor, enabling the operator to change the direction of the winch drum rotation.

9 Remote Control The remote control plugs into the winch control box, allowing the operator to control the winch direction, as well as stand well clear of the wire rope while operating the winch.

⚠ WARNING

Never engage or disengage clutch if winch is under load, winch rope is in tension or drum is moving.

Winch Mechanics

Now that you've familiarized yourself with your Warn winch and its components, we can begin reviewing how it works. The major advantage of an electric-powered winch is that it can provide reliable service for intermittent utility and recreational use even while the vehicle's engine is stalled — assuming, of course, that sufficient battery current is available. Your winch can operate at high current loads, and, for this reason, the control box uses a high current control system to safely handle the current flow.

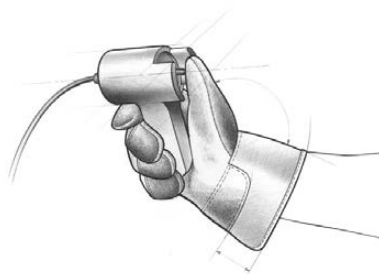

Control Of Your Winch

The winch is controlled by the hand held remote control to allow the operator to stand clear while controlling the winching process. The remote control provides control of the forward or reverse rotation of the spooling drum.

How the Winch Reacts to Load

Warn winches are rated by pulling capacity. The maximum pulling capacity occurs on the first layer of wire rope on the drum. As the layers increase, the pulling power decreases. It's the mathematics of winching. Exceeding the winch capacity could cause the winch to fail or the wire rope to break. Thinking through how you intend to use your winch now, could save you a big headache later.

In addition, you'll also want to make sure that your winch's mounting system and your vehicle's frame can accommodate the rated load of your winch.

So analyze your situation. Use your judgement to calculate how much weight you intend to pull. Calculate the gross weight and multiply by 1.5 and then do not exceed the rating of your winch or wire rope.

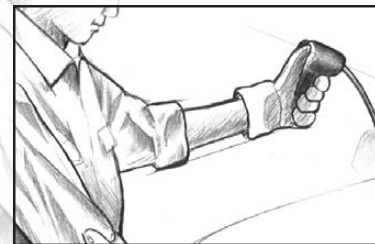

The winch is controlled by the hand held remote control to allow the operator to stand clear during the winching process.

It is important to understand that the longer the pull, the more heat that is created, just like a hot plate. Prolonged winching without cooling the winch motor will damage the motor. Also, if the engine is idling during winching, the battery may drain faster than it is charging. So pay close attention to your voltage gauge to make sure you aren't draining your battery too low to start your vehicle.

Alone, the winch is not much more than a simple tool. But when used with certain accessories and enhancements, your Warn winch can become a versatile and productive tool. In this section, we'll review several of these items. Some are vital to the safe operation of your winch, while others offer added versatility and convenience.

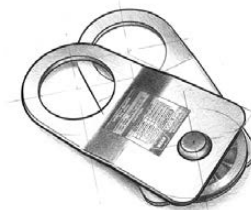

Snatch Block Used properly, the multi-purpose snatch block allows you to: (1) increase your winch's pulling power; and (2) change your pulling direction without damaging the wire rope. Proper use of the snatch block is covered in "Before You Pull".

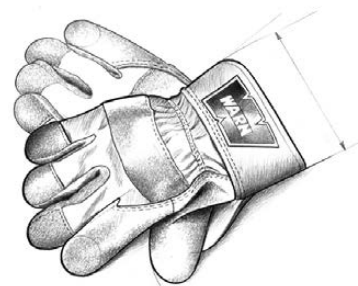

Gloves Wire rope, through use, will develop "barbs" which can slice skin. It is extremely important to wear protective gloves while operating the winch or handling the wire rope. Avoid loose fitting clothes or anything that could become entangled in the wire rope and other moving parts.



Clevis/D-Shackles The D-Shackle is a safe means for connecting the looped ends of cables, straps and snatch blocks. The shackle's pin is threaded to allow easy removal.

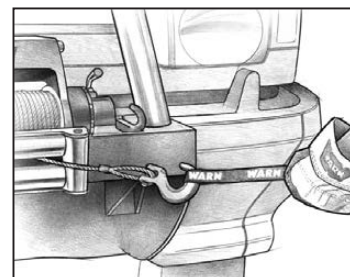

Hook Strap Use to hold the hook and keep fingers away from the fairlead as the wire rope is being spooled in. Winches develop tremendous pulling forces and can easily remove fingers and limbs that are placed in pinch points. Put the hook into the loop and hold the strap between the thumb and forefingers.



Choker Chain Can be used to hook-up to another vehicle or sharp objects for an anchor point. Chains, however, will damage or kill trees.

Tow Hooks Secured properly to your vehicle's frame, tow hooks provide an attachment point for wire hooks, straps, and chains.



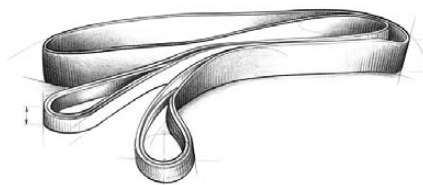

Tree Trunk Protector Typically made of tough, high-quality nylon, it provides the operator an attachment point for the winch rope to a wide variety of anchor points and objects, as well as protect living trees.



Recovery Strap Never use a recovery strap in a winching operation. Because it is designed to stretch, it stores energy and could react like a rubber band should your rigging fail. Use the recovery strap to “snatch” out a stuck vehicle.

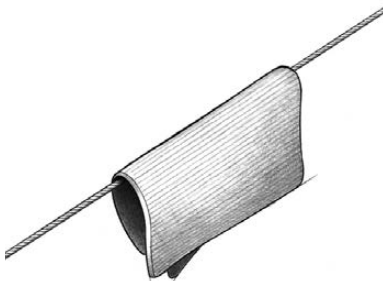

Heavy Blanket In certain situations you may decide to throw a heavy blanket or similar object over the wire rope. A heavy blanket, such as a quilted mover’s blanket, can absorb energy should the wire rope break. Place it on the wire rope midway between the winch and the anchor point. Do this before the wire rope is put under

tension. Do not approach or move the blanket once tension is applied. Do not allow it to get pulled into the fairlead. If necessary to move or remove the blanket, slack the tension on the wire rope first.

Shovels & Hand Tools Quite often during winching activities, you’ll find yourself in need of some additional help. You may want to stow equipment such as a shovel, an axe and a Hi-Lift jack for additional assistance when needed.

Backup Parts Important backup parts to carry for backcountry travel should include an extra screw-pin shackle, snatch block, and remote control. For severe and continued winch use, consider including an extra wire rope and winch hook.

Toolbox Items Items to bring along include hand wrenches, screwdrivers, pliers, and tools to change wire rope.

Booster Cables Many roadside emergencies stem from a dead battery. To prevent exhausting your electrical source, you can install a dual battery system and a battery isolator kit. Also, it’s wise to include battery booster cables and the Warn quick-connect cable system.

Battery Recommendations A fully charged conventional automotive battery with a minimum rating of 650 cold cranking amps is recommended to obtain peak performance from your winch. Make sure all electrical connections are clean and tight.

CAUTION

Never use a strap for winching.
Never use a strap for towing. The strap can be easily cut or abraded.
Never use “bungie” straps that develop tremendous and potentially dangerous amounts of force when stretched.

Practice using your winch before you get stuck. A real situation is no time to be learning how to use your winch. Make sure new wire rope is stretched before it is first used.

Stretching Wire Rope

The life of a wire rope is directly related to the use and care it receives. During its first use, a new wire rope must be spooled onto its drum under a load of at least 1000 lbs. (454 kgs). Use the following instructions to properly stretch the wire rope onto the winch drum.

1) Choose a FLAT AND LEVEL location that is large enough to run out the entire length of wire rope.

2) Turn the clutch lever on the winch to the “Free Spool” position. Spool out the wire rope to the last 5 wraps on the drum. Once the wire rope is spooled out, turn the clutch lever on the winch to the “Engaged” position.

3) Attach the hook end of the rope to a suitable anchor point and back the vehicle away from the anchor point until there is very little slack in the wire rope. Before getting out of the vehicle, set the parking brake, place the vehicle in gear or park and turn the vehicle off.

4) Connect the remote control to the winch. Standing approximately 8 ft away from the winch, power in the winch until all of the slack is wound onto the winch drum. Disconnect the remote control from the winch. Hold tension on the wire rope with one hand; carefully push the wire rope to the side of the drum the wire rope is attached to so there are no gaps between each coil on the drum. Be sure to check that the wire rope is winding off of the bottom of the drum, not the top, or the automatic load holding brake will not function properly. (If the wire rope is winding off the top you have powered the winch “out” instead of “in” on the remote control).

5) The following steps should be done using two people for proper safety. If you attempt to tension your wire rope alone be sure to always engage the parking brake, place the transmission in gear and turn the vehicle off every time you exit the vehicle to inspect the winch wire rope. Never exit the vehicle with a load on the winch wire rope.

Tensioning the wire rope is critical to ensure a long product life. Tensioning the wire rope will prevent outer layers of wire rope from pinching and deforming the inner layers.

6) Use care to evenly wrap each layer to prevent damage to the rope.

7) Pass the remote control through the driver’s window for the driver of the vehicle to operate. Instruct your assistant to stand to the side of the vehicle and away from the winch wire rope. Your assistant should signal you if the wire rope is winding correctly by watching it move across the fairlead as the wire rope is powered in. Start the vehicle and place the transmission in neutral. Release the parking brake while applying moderate brake pedal pressure. Press power in on the remote control switch. After winching in for approximately 6 ft, stop winching. Slowly let up off of the brake pedal and then apply the parking brake. This will ensure that there is no load on the winch rope. Then place the transmission in park or gear and turn the vehicle off. Exit the vehicle and inspect the winch to make sure that the wire rope is being evenly wound onto the winch drum and not sinking into the lower layer. If the wire rope is sinking, power the wire rope out and repeat this step from the beginning with more brake pedal pressure.

8) When you are convinced the wire rope is winding onto the winch drum properly, repeat step 6 until the vehicle is within 6 ft of the winch anchor. Once within 6 ft, slowly let up off of the brake pedal and then apply the parking brake. This will ensure that there is no load on the winch wire rope. Then place the transmission in park or in gear and turn the vehicle off. Exit the vehicle. Disconnect the hook from the anchor. While holding onto the supplied hook strap, hold tension on the winch rope and slowly power in the winch by “pulsing” the power in on the remote control until the hook is within 3 ft of the fairlead. Stop winching in and attach the hook to a suitable anchor point on the vehicle. DO NOT POWER THE HOOK INTO THE FAIRLEAD. This could cause damage to the fairlead. Once the hook is suitably attached to the vehicle, power in the remaining slack in the winch rope by “pulsing” the power in on the remote until there is minimal slack in the winch wire rope.

WARNING

Never operate winch with less than 5 wraps of rope around the drum. Rope could come loose from the drum, as the rope attachment to the drum is not designed to hold a load.

Whether you're recovering another vehicle or pulling a stump from the ground, knowing the proper winching techniques can help keep you and others around you safe. And perhaps the most important part of the winching process, regardless of the situation, is what you do before you pull.

In this section, we'll show you the basic fundamentals for effective winching. However, it is up to you to analyze the situation and make the decisions necessary for the proper use of your winch. Apply your knowledge of your winch and the basic fundamentals you've practiced and adjust your techniques to your unique situation. Some keys to remember when using your Warn winch:

1. **Always take your time to assess your situation and plan your pull carefully.**
2. **Always take your time when using a winch.**
3. **Use the right equipment for your situation.**
4. **Always wear leather gloves and do not allow the wire rope to slide through your hands.**
5. **You and only you should handle the wire rope and operate the remote control switch.**
6. **Think safety at all times.**
7. **Practice. Practice and practice the steps.**

⚠ WARNING
Always use supplied hook strap whenever spooling winch rope in or out, during installation or operation to avoid injury to hands and fingers.

⚠ WARNING
Always keep hands clear of winch rope, hook loop, hook and fairlead opening during installation, operation, and when spooling in or out.



Rigging for the Pull

The following steps describe how to recover your vehicle with rigging a single line pull. Double or multiple line rigging techniques follow the same basic steps, but use a snatch block to assist the process.

Step 1: PUT ON GLOVES.

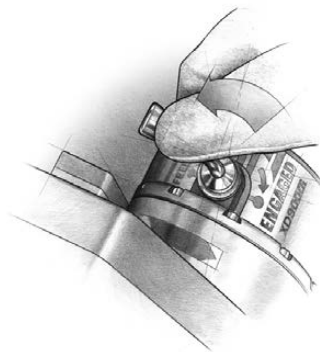

Step 2: DISENGAGE CLUTCH. To allow free spooling of the winch drum, rotate the clutch lever on the winch to Disengage. Freespooling conserves battery power.

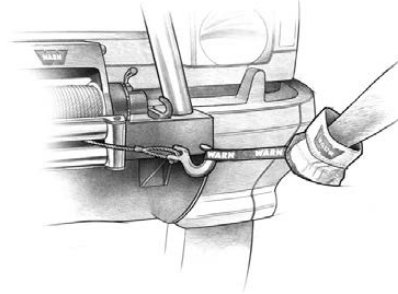

Step 3: FREE THE WINCH HOOK AND ATTACH HOOK STRAP. Free the winch hook from its anchor point. Attach hook strap to the hook (if not attached).



Step 4: PULL WIRE TO ANCHOR POINT. Pull out enough wire rope to reach your anchor point. Be sure to keep a certain amount of tension in the wire. It can become twisted and overwrap when slackened, leading to wire rope damage. To prevent losing the end, hold the winch hook in the hook strap while you work.



Step 5: SECURE TO THE ANCHOR POINT. Once you've established your anchor point, secure the tree trunk protector or choker chain around the object.

Step 6: ATTACH THE CLEVIS/D-SHACKLE AND HOOK STRAP. Attach the shackle to the two ends of the strap or chain and through the hook loop, being careful not to over tighten (tighten and back-off 1/2 turn).



How to choose an anchor point:

A secure anchor is critical to winching operations. An anchor must be strong enough to hold while winching. Natural anchors include trees, stumps, and rocks. Hook the cable as low as possible. If no natural anchors are available, when recovering another vehicle, your vehicle becomes the anchor point. In this case, be sure to put the transmission in neutral, apply the hand brake and block its wheels to prevent your vehicle from moving.

Ideally, you'll want an anchor point that will enable you to pull straight in the direction the vehicle will move. This allows the wire rope to wind tightly and evenly onto the spooling drum. An anchor point as far away as possible will provide the winch with its greatest pulling power.

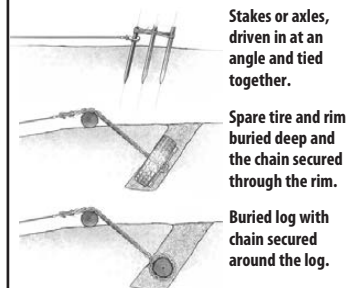

Stakes or axles, driven in at an angle and tied together.
Spare tire and rim buried deep and the chain secured through the rim.
Buried log with chain secured around the log.

⚠ WARNING
Never engage or disengage clutch if winch is under load, winch rope is in tension or drum is moving.

⚠ CAUTION
Never leave remote control where it can be activated during free spooling, rigging, or when the winch is not being used.

⚠ WARNING
Never wrap winch rope back onto itself. Use a choker chain or tree trunk protector on the anchor.

⚠ WARNING

Never use winch as a hoist or to suspend a load.

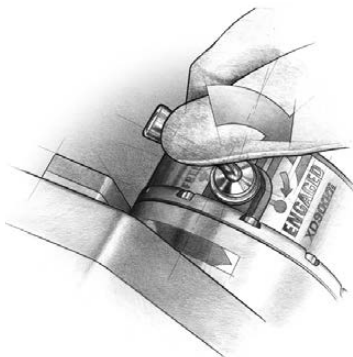

Step 7: LOCK THE CLUTCH. Lock the winch drum by rotating the clutch lever on the winch to Engage.

⚠ WARNING

Never use winch or winch rope for towing. Shock loads can damage, overload and break rope.

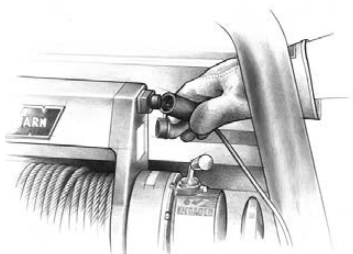

Step 8: CONNECT THE REMOTE CONTROL. Be careful not to let the remote control cord dangle in front of the winch. If you choose to control the winch from inside your vehicle, always pass the remote through a window to avoid pinching the cord in the door.

Always disconnect the remote control when not in use.

⚠ WARNING

Never operate winch with less than 5 wraps of rope around the drum. Rope could come loose from the drum, as the rope attachment to the drum is not designed to hold a load.



Step 9: PUT WIRE ROPE UNDER TENSION. Using the winch switch, slowly wind the wire rope until no slack remains. Once the wire rope is under tension, stand well clear, and never step over it.

Step 10: CHECK YOUR ANCHOR. Make sure all connections are secured and free of debris before continuing with the winching procedure.

PULLING

As you probably have already noticed, there are many things to do and consider before you actually begin pulling. Think through what you're doing and you can keep yourself and those around you out of harm's way.

Operating your winch properly is so important, in fact, you should practice these techniques before having to face the distractions and stresses of a real winching situation.

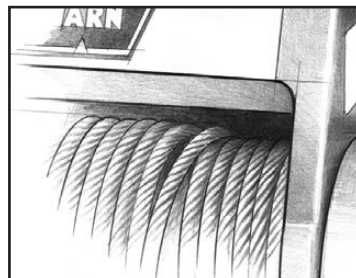

Step 11: CHECK WIRE ROPE. The wire rope should be neatly wound around the spooling drum. Improper winding can cause damage to the wire rope.

Step 12: LAY SOMETHING OVER THE WIRE ROPE, if you decide it is necessary, midway between the winch and the anchor point to absorb energy should the wire rope snap loose. Tree limbs, heavy jackets, chain, back pack and the like may be used for this purpose.

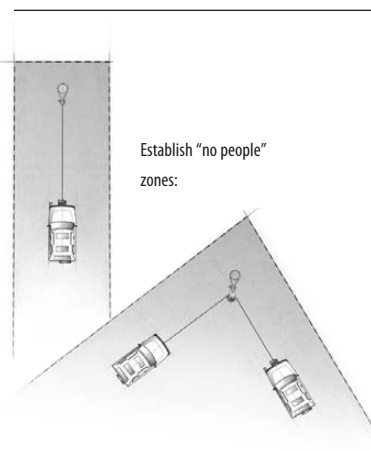
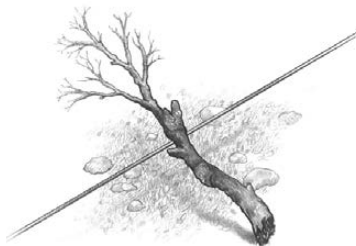

Step 13: MAKE YOUR INTENTIONS CLEAR. Be sure that everyone in the immediate vicinity surrounding the winching operation is completely aware of your intentions before you pull.

Declare where the spectators should not stand — never behind or in front of the vehicle and never near the wire rope or snatch block. Your situation may have other "no people" zones.



Step 14: BEGIN WINCHING. With the winching vehicle's engine on and light tension already on the wire rope, begin winching slowly and steadily. Be sure that the wire rope is winding evenly and tightly around the spooling drum. For additional assistance, the winched vehicle can be slowly driven while being pulled by the winch.

Step 15: FOR VEHICLE RECOVERY, continue pulling until the vehicle is on stable ground. If you are able to drive the vehicle, the winching operation is complete.

Step 16: SECURE VEHICLE. Once recovery of the vehicle is complete, be sure to secure the vehicle's brakes and put the Transmission in "park" (automatic) or "low" gear for (manual) transmissions. Release tension in the wire rope.

What to look for under load

The wire rope must always spool onto the drum as indicated by the drum rotation decal on the winch.

As you power in, make sure the wire rope winds evenly and tightly on the drum. This prevents the outer wire wraps from drawing into the inner wraps, binding and damaging the wire rope.

Avoid shock loads by using the control switch intermittently to take up wire rope slack. Shock loads can momentarily far exceed the drum and wire rope ratings.

During side pulls the wire rope tends to stack up at one end of the drum. This stack can become large enough to cause serious damage to the winch. So, line up pulls as straight ahead as possible and stop winching if the wire rope comes close to the tie rods or mounting plate. To fix an uneven stack, spool out that section of the rope and reposition it to the opposite end of the drum which will free up space for continued winching.

NOTICE

Avoid overheating the winch motor. For extended winching, stop at reasonable intervals to allow the winch motor to cool down.

Winching hand signals

In some situations, recovery could involve two people. One drives and controls the winch, while the other provides navigation instructions and ensures the wire rope is winding properly. You and your helper must establish clear and precise hand signals and review so everyone clearly understands. It should also be understood that if the driver controlling the winch cannot see both hands of the assistant, the winch should not be activated. Suggested signals:

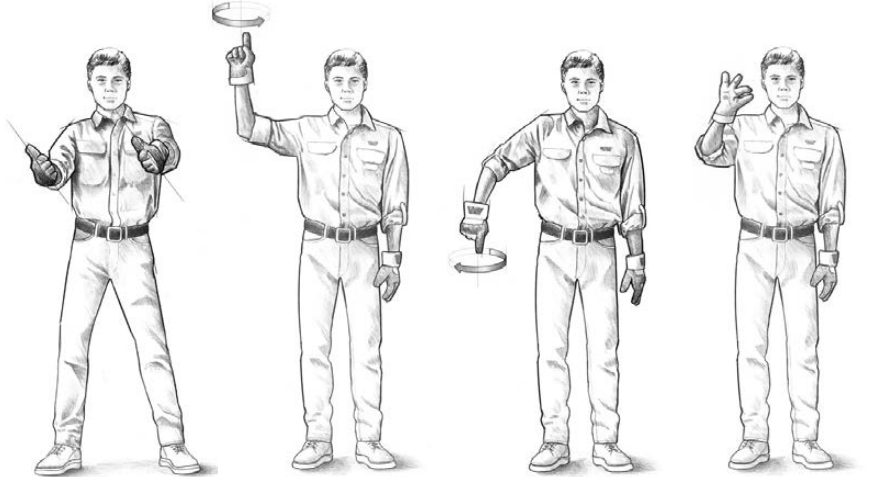

1) Direction of steering
Hold your arms out with thumbs up and tilt your hands in the direction you advise the driver to steer.

2) Power in the wire rope
Hold your forefinger in the air above your shoulder height and draw small circles in the air to indicate to wind the winch.

3) Power out the wire rope
Hold your forefinger pointing down and draw circles in the air at about waist height to indicate feeding more wire from the winch.

4) Pulse wind the wire rope
Tells the driver to wind the winch in short, quick bursts. Open and close the two fingertips until you want the winch to stop.

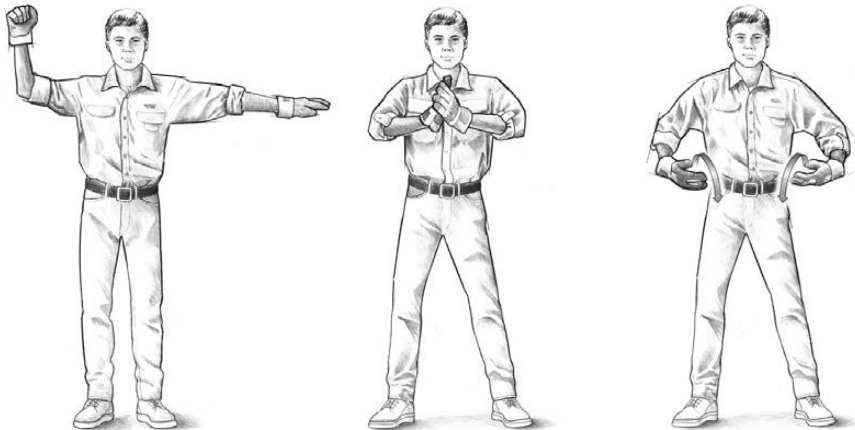

5) Stop the winch
Clinch fist, palm to driver, held high enough for driver to see and other arm straight out at shoulder height is the sign to stop the winch.

6) Braking
Cross your palms together to tell the driver to apply the foot brake.

7) Drive assist
Tells driver to give the tires more drive force to assist the winching process.



How to spool under no load

Arrange the remote control lead so it can not be caught in the winch. Arrange the wire rope so it will not kink or tangle when spooled. Be sure any wire rope already on the spooling drum is wound tightly and evenly layered. Tighten and straighten the layer if necessary. Keep the wire rope under light tension and spool the wire rope back onto the winch drum in even layers. Stop frequently to tighten and straighten the layers as necessary. Repeat this process until the winch hook is the same distance as the full length of the remote control from the winch. Pinch the hook between your thumb and forefinger and attach the hook strap. Hold the hook strap between the thumb and forefinger to keep tension on the wire rope. Walk the wire rope towards the fairlead, carefully spooling in the remaining wire rope by pulsing the remote control switch. Store the hook at the fairlead or tensioned to a suitable location to the side.

If you do not have the hook strap, use a length of cord or something similar. To prevent serious injury, NEVER put your fingers inside the hook area as you are powering in.

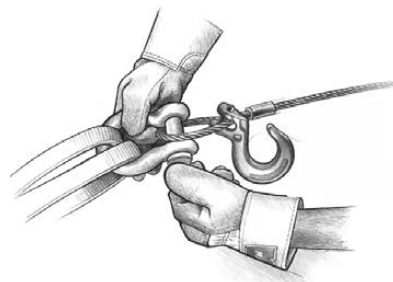

Step 17: DISCONNECT WIRE ROPE.
Disconnect from the anchor.



Step 18: REWIND WIRE ROPE. The person handling the wire rope should walk the rope in and not let it slide through the hand and control the winch at all times.

WARNING
Always keep hands clear of winch rope, hook loop, hook and fairlead opening during installation, operation, and when spooling in or out.

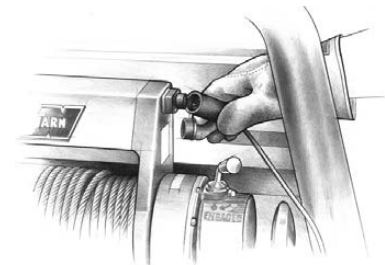

Step 19: DISCONNECT REMOTE CONTROL. Disconnect the remote control cord from the control box and store in a clean and dry place. Winching operations are now complete. Put the cap on the solenoid plug in.

Various winching situations will require application of other winching techniques. These could range from too little distance to achieve maximum pull using straight line rigging, simply increasing pulling power, or maintaining a straight-line pulling situation. You will have to assess what technique is correct for your situation. Think "safety" at all times.

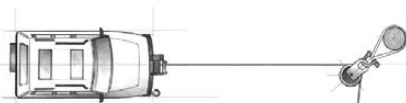
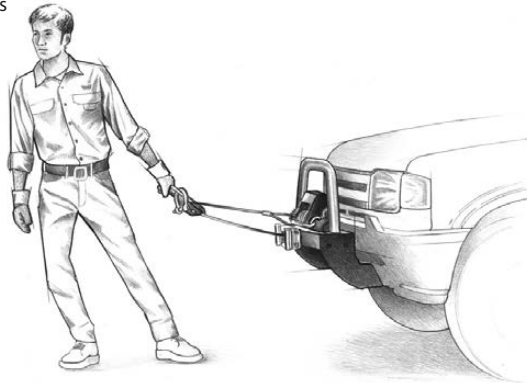

How to change the pulling direction

All winching operations should have a straight line from the winch to the object being pulled. This minimizes the wire rope collecting on one side of the drum affecting pulling efficiency and damaging wire rope. A snatch block, secured to a point directly in front of the



vehicle, will enable you to change your pulling direction while still allowing the wire rope to be at 90° to wind properly onto the spooling drum.

Increasing pulling power

In some cases, you may find yourself needing more pulling power. The use of snatch blocks increases mechanical advantage and that increases your pulling power:

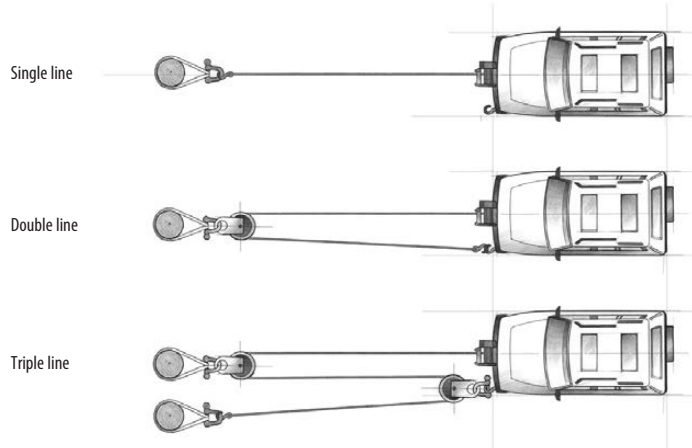

Double line

Because pulling power decreases with the number of layers of wire rope on the winch drum, you can use a snatch block to double line out more wire rope. This decreases the number of layers of wire rope on the drum, and increases pulling power.

Start by feeding out enough wire rope to free the winch hook. Attach the hook to your vehicle's frame/tow hook and run the wire rope through a snatch block.

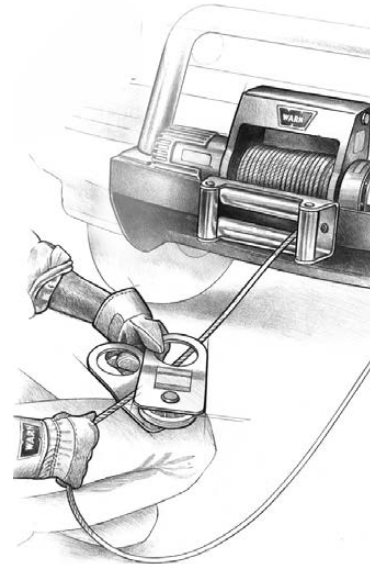

Triple Line

Use the same techniques as the Double Line. Select a robust mounting location on your vehicle for the snatch block and the screw-pin shackle. Keep a 90° angle between the winch and run the wire rope to the first anchor-point and through the snatch block. Secure rope back to the vehicle. Put the wire rope through the snatch block and secure with the screw-pin shackle on the vehicle as close to the winch as practical. Now run the wire rope to the final anchor point.

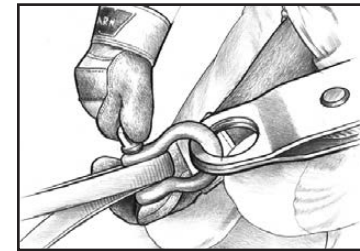

Secure to the anchor point with a tree trunk protector or choker chain. Attach the clevis/shackle. Attach the shackle to the two ends of the strap/chain, being careful not to over tighten (tighten and back-off 1/2 turn).

Secure the winch hook. While keeping the line near the ground, insert the winch hook through the screw-pin shackle. Check your anchor. Make sure all connections are secured and free of debris before continuing with the winching procedure.

Disengage the clutch and, using the snatch block, pull out enough wire to reach your anchor point. Do not attach hook to mounting kit.

Secure to the anchor point with a tree trunk protector or choker chain. Attach the clevis/shackle. Attach the shackle to the two ends of the strap/chain, being careful not to over tighten (tighten and back-off 1/2 turn).

MAINTENANCE

THE FINAL ANALYSIS

- Inspect the wire rope before and after each winching operation. If the wire rope has become kinked or frayed, the wire rope needs to be replaced. Be sure to also inspect the winch hook and hook pin for signs of wear or damage. Replace if necessary.
- Keep winch, wire rope, and switch control free from contaminants. Use a clean rag or towel to remove any dirt and debris. If necessary, unwind winch completely (leaving a minimum of 5 wraps on spooling drum), wipe clean, and rewind properly before storage. Using a light oil on the wire rope and winch hook can keep rust and corrosion from forming.
- Operating your winch for a long period of time places an extra burden on your vehicle's battery. Be sure to check and maintain your battery and battery cables according to manufacturer guidelines. Also inspect switch control and all electrical connections to be certain they are clean and tight fitting.
- Inspect the remote control for damage, if so equipped. Be sure to cap the remote socket to prevent dirt and debris from entering the connections. Store remote control in a protected, clean, dry area.
- No lubrication is required for the life of the winch.

The basic guide to proper winching techniques cannot cover all the possible situations in which you may need to use a winch. In the final analysis, the decisions you make will determine the final outcome. So think through each situation and each step of use. Always be mindful of your own safety and the safety of others. Pay attention and you'll have fun.

WARNING

Never operate winch with less than 5 wraps of rope around the drum. Rope could come loose from the drum, as the rope attachment to the drum is not designed to hold a load.