

## Exhaust gas recirculation



Catalog





Top OEM-  
quality

■ **Variety made to measure**

*BorgWarner Emissions Systems offers suitable Wahler spare parts for 62 auto- mobile brands!*

■ **BorgWarner worldwide**

*BorgWarner is represented in all the world's important markets with its own subsidiaries and a dense service network. For more information, visit [aftermarket.borgwarner.com](http://aftermarket.borgwarner.com)*

■ **Service products included**

*BorgWarner Emissions Systems knows its customers' needs and always supplies original Wahler thermostats together with the matching gasket!*

# Contents

*EGR system*

2 - 25

*Cross references*

26 - 30

<b>Hersteller</b>	
ALFA ROMEO	2
AUDI	2
BMW	4
CHEVROLET	5
CITROËN	6
FORD	6
IVECO	6
LANCIA	7
MERCEDES BENZ	7
MULTICAR	13
OPEL	13
PEUGEOT	15
PUCH	15
SAAB	15
SEAT	15
SKODA	18
VAUXHALL	19
VOLKSWAGEN	20

## About us

**BorgWarner Thermal Systems** is a leading supplier of components and systems for thermal management.

**BorgWarner Morse TEC** is the global leader of automotive chain systems and components for engine timing, automatic transmission and four-wheel drive applications.

**BorgWarner TorqTransfer Systems** is a leading manufacturer of torque distribution and management systems for four-wheel drive vehicles.

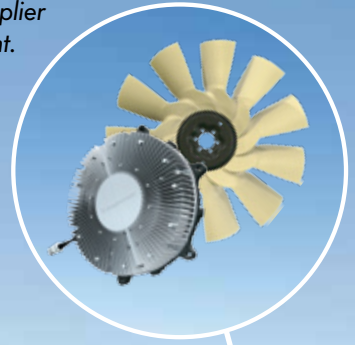



**BorgWarner Turbo Systems** is a leading manufacturer of turbochargers for passenger cars and commercial vehicle markets.

**BorgWarner Emissions Systems** is a leading manufacturer in the design and supply of exhaust gas recirculation (EGR) systems, ignition technology, diesel cold-start technology, cabin heaters and thermostats.

**BorgWarner Transmission Systems** supplies "shift quality" components and systems to virtually every automatic transmission manufacturer.

*Innovations for the aftermarket.  
From the product leader in the field of  
drive technology.*

*Many auto manufacturers all over the world agree on one thing: If they want their engines to meet the toughest emissions standards and break new ground in terms of fuel economy, if they want to combine excellent performance with a high level of reliability, then BorgWarner is the only choice. As product leader in the field of drive technology, we support the automotive industry in developing the vehicle generation of tomorrow. BorgWarner is also the perfect choice in the aftermarket. And not just because of the already legendary quality of our products. But also because of the selection, the range of services and the speed we offer our partners in the spare parts business.*

*Our solutions:  
precise, reliable, economical.*

*BorgWarner's Emissions Systems business unit is a leading global manufacturer and supplier of the latest exhaust gas emissions control systems, ignition technology, diesel cold-start technology, PTC interior heaters and thermostats for passenger vehicles and commercial vehicles all over the world. And with the product range of Wahler, which was acquired by BorgWarner in April 2014 and has been integrated into the Emissions Systems business unit, the product portfolio has been further expanded with a multitude of innovative solutions for the exhaust gas and temperature management of modern engines. Wahler will retain its product brand in the aftermarket segment.*

ALFA ROMEO		Type	Engine	Ltr.	Year	Restriction*	Article	Type
159	2.0 JTDM	844 A2.000 939 B3.000	2	05.2009-11.2011			710559D▲	V
159	2.0 JTDM	939 B4.000	2	06.2010-11.2011			710559D▲	V
BRERA	2.0 JTDM	844 A2.000	2	03.2008-			710559D▲	V
BRERA	2.0 JTDM	939 B3.000	2	05.2009-			710559D▲	V
GIULIETTA	1.6 JTDM	940 A3.000	1,6	04.2010-			710559D▲	V
GIULIETTA	2.0 JTDM	940 A4.000 940 A5.000 940 A7.000 940 A8.000 940 B6.000	2	04.2010-			710559D▲	V
MITO	1.6 JTDM	198 A2.000 955 A3.000 955 A4.000	1,6	09.2008-			710559D▲	V
SPIDER	2.0 JTDM	844 A2.000 939 B3.000	2	04.2009-			710559D▲	V
<b>AUDI</b>								
A2	1.2 TDI	ANY	1,2	03.2001-08.2005			7293D 710608▲	V A
A2	1.4 TDI	ATL / BHC	1,4	02.2000-08.2005			7271D	V
A2	1.4 TDI	AMF	1,4	06.2000-08.2005			7301D	V
A3	1.9 TDI	AGR	1,9	09.1996-07.2001	Chassis 8L-V-110 000→		7293D 710608▲	V A
A3	1.9 TDI	AHF / ALH / ASV	1,9	09.1996-07.2001			7293D 710608▲	V A
A3	1.9 TDI	ASZ	1,9	09.2000-06.2003			7371D 710608▲	V A
A3	1.9 TDI	ATD	1,9	10.2000-06.2003			7293D 710608▲	V A
A3	1.9 TDI	AXR	1,9	10.2000-06.2003	oben / top unten / down		7496D 61306D 61384D 710336 665574D	V L L A D-S
A3	1.9 TDI	BKC	1,9	05.2003-	oben / top unten / down		7496D 61306D 61384D 710336 665574D	V L L A D-S
A3	1.9 TDI	BLS	1,9	05.2003-05.2010			710572D▲	V
A3	1.9 TDI	BXE	1,9	06.2006-05.2010	oben / top unten / down		7496D 61306D 61384D 710336 665574D	V L L A D-S
A3	2.0 TDI	AZV	2	05.2003-			7496D 710413	V A
A3	2.0 TDI 16V	BKD	2	05.2003-			7496D 710413	V A
A3	2.0 TDI	CBAA	2	05.2003-	oben / top		665104D	L
A3	2.0 TDI 16V	CBAB	2	05.2003-	oben / top		665104D	L
A3	2.0 TDI	CBBB	2	03.2006-	oben / top		665104D	L
A3	2.0 TDI	BMM	2	06.2005-06.2008			710572D▲	V

## AUDI

AUDI	Typ	Engine	Ltr.	Year	Restriction*	Article	Typ
A4	1.9 TDI	ATJ AJM	1,9	03.2000-09.2001		<b>7241D</b>	V
						<b>710558</b>	A
					Schaltgetriebe manual gearbox	<b>60409D</b>	L
					Automatikgetriebe autom. gearbox	<b>60700D</b>	L
					oben / top		
		Automatikgetriebe autom. gearbox		<b>60364D</b>	L		
		unten / down		<b>665574D</b>	D-S		
A4	1.9 TDI	AVB	1,9	05.2001-12.2004		<b>7241D</b>	V
						<b>710558</b>	A
					Schaltgetriebe manual gearbox		
					Automatikgetriebe autom. gearbox	<b>710336</b>	A
		Schaltgetriebe manual gearbox		<b>60409D</b>	L		
		Automatikgetriebe autom. gearbox		<b>60700D</b>	L		
		oben / top					
		Automatikgetriebe autom. gearbox		<b>60364D</b>	L		
		unten / down		<b>665574D</b>	D-S		
A4	1.9 TDI	AWX AVF	1,9	11.2000-12.2004		<b>7372D</b>	V
						<b>710558</b>	A
					Schaltgetriebe manual gearbox		
					Automatikgetriebe autom. gearbox	<b>60633D</b>	L
					oben / top		
		Automatikgetriebe autom. gearbox		<b>60702D</b>	L		
		unten / down		<b>60364D</b>	L		
				<b>665574D</b>	D-S		
A4	1.9 TDI	BKE	1,9	06.2004-12.2004		<b>710571D▲</b>	V
A4	1.9 TDI	BRB / BKE	1,9	11.2004-06.2008		<b>710571D▲</b>	V
A4	1.9 TDI	BKE	1,9	06.2004-06.2008	unten / down	<b>60364D</b>	L
A4	1.9 TDI	BRB	1,9	11.2004-06.2008	unten / down	<b>60364D</b>	L
A4	2.0 TDI	BPW	2	11.2004-03.2009		<b>710571D▲</b>	V
A4	2.0 TDI	BPW	2	11.2004-06.2008	unten / down	<b>60364D</b>	L
A4	2.5 TDI	AFB/AKN	2,5	09.1997-11.2000	oben / top	<b>60415D</b>	L
					unten / down	<b>60347D</b>	L
A4	2.5 TDI	AKE / BAU	2,5	10.2000-12.2004	oben / top	<b>60415D</b>	L
					unten / down	<b>60347D</b>	L
A4	2.5 TDI	AYM	2,5	08.2001-07.2002	oben / top	<b>60415D</b>	L
					unten / down	<b>60347D</b>	L
A4	2.5 TDI	BFC / BCZ	2,5	07.2002-12.2004	oben / top	<b>60415D</b>	L
					unten / down	<b>60347D</b>	L

AUDI							
	Type	Engine	Ltr.	Year	Restriction*	Article	Type
A6	1.9 TDI	AJM	1,9	07.2000-01.2005		7241D	V
						710558	A
					Schaltgetriebe manual gearbox	60409D	L
					Automatikgetriebe autom. gearbox oben / top	60700D	L
					Automatikgetriebe autom. gearbox unten / down	60364D	L
					665574D	D-S	
A6	1.9 TDI	AWX AVF	1,9	08.2001-01.2005		7372D	V
						710558	A
					Schaltgetriebe / manual gearbox	60633D	L
					Automatikgetriebe autom. gearbox oben / top	60702D	L
					Automatikgetriebe autom. gearbox unten / down	60364D	L
					665574D	D-S	
A6	2.5 TDI	AFB / AKN	2,5	07.1997-01.2005	oben / top unten / down	60415D 60347D	L L
A6	2.5 TDI	AKE / BAU	2,5	02.2000-01.2005	oben / top unten / down	60415D 60347D	L L
A6	2.5 TDI	AYM	2,5	08.2001-01.2005	oben / top unten / down	60415D 60347D	L L
A6	2.5 TDI	BCZ / BFC	2,5	07.2002-01.2005	oben / top unten / down	60415D 60347D	L L
A8	2.5 TDI	AFB / AKN	2,5	01.1997-04.2000	oben / top unten / down	60415D 60347D	L L
A8	2.5 TDI	AKE / BAU	2,5	05.2000-08.2005	oben / top unten / down	60415D 60347D	L L
A8	2.5 TDI	BCZ	2,5	05.2003-08.2005	oben / top unten / down	60415D 60347D	L L
TT	2.0 TDI	CBBB	2	06.2008-	oben / top	665104D	L
BMW							
1er	116d 118d 120d 123d 125d	N47	2	03.2009- 03.2007- 03.2007- 10.2007- 02.2012-		710327D	V
1er	118d 120d	M47	2	09.2004- 09.2004-		60579D	L
1er	116i 118i 120i	N43	2	01.2009- 04.2007- 03.2007-		7574D	V
3er	318d 320d 325d 330d 335d	M47	2	09.2001- 04.1998-		60579D	L
		M57	3	09.2006- 10.1999- 09.2006-			



**BMW**

	Typ	Engine	Ltr.	Year	Restriction*	Article	Typ	
3er	316d	N47	2	07.2009-		710327D	V	
	318d		2	09.2005-				
	320d		2	01.2005-				
	325d	N57	3	01.2010-				
	330d		3	01.2009-				
3er	316i	N43	1,6	09.2007-		7574D	V	
	318i		2	09.2007-				
	320i			03.2007-				
5er	520d	M47	2	07.2005-		60579D	L	
	525d	M57	2,5	02.2000-				
	530d		3	08.1998-				
	535d			09.2004-				
5er	520d	N47	2	07.2005-		710327D	V	
	525d	N57		03.2010-				
	530d		3	03.2010-				
	535d			09.2010-				
	M 550d			01.2012-				
5er	520i	N43	2	09.2007-		7574D	V	
5er GT	530d	N57	3	10.2009-		710327D	V	
	535d							
6er	640d	N57	3	06.2011-		710327D	V	
7er	730d	M57	3	08.1998-		60579D	L	
7er	730d	N57	3	10.2008-		710327D	V	
	740d							
X1	18d	N47	2	03.2009-		710327D	V	
	20d							
	23d							
X3	20d	M47	2	10.2004-		60579D	L	
	30d	M57	3	09.2006-				
X3	18d	N47	2	09.2007-		710327D	V	
	20d							
	30d	N57	3	05.2011-				
	35d							
X5	30d	M57	3	05.2001-		60579D	L	
	35d			09.2008-				
X5	30d	N57	3	09.2008-		710327D	V	
	40d							
X6	30d	M57	3	05.2008-		60579D	L	
X6	30d	N57	3	09.2008-		710327D	V	
	40d							

**CHEVROLET**

ASTRA	2.0 DTI 16V	Y 20 DTH	2	09.2002-07.2004	Pneumatisch, Metalldeckel / Pneumatic, Metal cover	7188D	V
ASTRA	2.0 DTI 16V	Y 20 DTH	2	09.2002-07.2004	Pneumatisch, Kunststoffdeckel schwarz / Pneumatic, Plastic cover in black	7211D	V
ASTRA G	2.0 DTI 16V	Y 20 DTH	2	09.2002-07.2004	Elektrisch / Electric	7375D	V

<b>CITROËN</b>	Type	Engine	Ltr.	Year	Restriction*	Article	Type
JUMPER	3.0 HDI 160		3	09.2006-		7631D	V
						7523D	D
BRAVO II	1.6 D Multijet	198 A2.000 198 A3.000 198 A6.000 955 A4.000	1,6	03.2008-		710559D▲	V
BRAVO II	2.0 D Multijet	198 A5.000 844 A2.000	2	09.2008-		710559D▲	V
DOBLO	1.6 D Multijet	198 A3.000 263 A3.000 263 A4.000	1,6	02.2010-		710559D▲	V
DOBLO	2.0 D Multijet	263 A1.000	2	02.2010-		710559D▲	V
DUCATO	115 Multijet 2.0 D	250 A1.000	2	06.2011-		710559D▲	V
DUCATO	120 Multijet 2.3 D	F1AE0481D	2,3	07.2006-		7497D	D
DUCATO	130 Multijet 2.3 D		2,3	07.2006-		7497D	D
DUCATO	160 Multijet Power 3.0 D	F1CE0481D	3	07.2006-		7631D	V
						7523D	D
DUCATO	2.8 D	8140,63	2,8	02.1998-04.2002		7350D	V
FREEMONT	2.0 JTD	939 B5.000	2	08.2011-		710559D▲	V
IDEA	1.6 D Multijet	350 A2.000	1,6	05.2008-		710559D▲	V
LINEA	1.6 D Multijet	198 A3.000	1,6	06.2009-		710559D▲	V
PUNTO	1.6 D Multijet	955 A3.000	1,6	07.2008-		710559D▲	V
SEDICI	2.0 D Multijet	D20AA	2	06.2006-		710559D▲	V
<b>FORD</b>							
GALAXY	1.9 TDI	ANU	1,9	06.2000-08.2006		7241D	V
						710558	A
GALAXY	1.9 TDI	AUY / ASZ	1,9	04.2000-05.2006		7372D	V
						710558	A
GALAXY	1.9 TDI	BTB	1,9	05.2005-08.2006		7372D	V
						710558	A
<b>IVECO</b>							
MASSIF	3.0 HPI / HPT	F1CE 0481	3	10.2008-		7631D	V
						7523D	D
DAILY I	30-8 35-8	8140,63	2,8			7350D	V
DAILY II	29L9 35S9 35C9	8140,63	2,8			7350D	V
DAILY III	35C15 35C18 35S18 40C15 40C18 45C15 45C18 50C15 50C18 60C15 60C18 65C15 65C18	F1CE 0481	3			7631D	V
						7523D	D

**IVECO**

	Typ	Engine	Ltr.	Year	Restriction*	Article	Typ
DAILY III	29L10 29L12 29L14 35C10 35S10 35C12 35S12 35S14 40C10 40S10 40C12	F1AE 0481	2,3			7497D	D

**LANCIA**

DELTA III	1.6 D Multijet	198 A2.000 944 A3.000 955 A4.000	1,6	08.2008-		710559D ▲	V
DELTA III	1.9 D Multijet	844 A1.000	1,9	01.2009-		710559D ▲	V
DELTA III	2.0 D Multijet	198 A5.000 198 A8.000 844 A2.000	2	09.2008-		710559D ▲	V
MUSA	1.6 D Multijet	350 A2.000 350 A3.000	1,6	07.2008-		710559D ▲	V

**MERCEDES-BENZ**

A-KLASSE	A 160 CDI A 170 CDI	OM 668	1,7	07.1998-08.2004		7234D	V
A-KLASSE	A 160 CDI A 180 CDI A 200 CDI	OM 640	2	09.2004-02.2008	mit / with DPF  Motor Nr. / engine no. →30455954	7504D  7545D	V  D
A-KLASSE	A 160 CDI A 180 CDI A 200 CDI	OM 640	2	03.2008-	mit / with DPF  Motor Nr. / engine no. 30455955→	710073D ▲	V
B-KLASSE	B 180 CDI B 200 CDI	OM 640	2	03.2005-02.2008	mit / with DPF  Motor Nr. engine no. →30455954	7504D  7545D	V  D
B-KLASSE	B 180 CDI B 200 CDI	OM 640	2	03.2008-	mit / with DPF  Motor Nr. / engine no. 30455955→	710073D ▲	V
C-KLASSE	C 200 CDI C 220 CDI	OM 646	2,1	02.2001-		7389D	V
C-KLASSE	C 320 CDI	OM 642	3	01.2005-		7527D	V
C-KLASSE	C 350 CDI	OM 642	3	07.2009-		7527D	V
C-KLASSE	C 200 CDI C 220 CDI	OM 646.811	2,1	01.2007-		7625D	V
C-KLASSE	C 30 CDI AMG	OM 612.990	3	01.2003-		7353D	V

# EGR

MERCEDES-BENZ	Type	Engine	Ltr.	Year	Restriction*	Article	Type
C-KLASSE	C 300 CDI	OM 642.830	3	08.2007-	Japan+USA	710095D▲	V
	C 350 CDI	OM 642.832					
C-KLASSE	C 300 CDI	OM 642.832	3	01.2011-		710164D▲	V
C-KLASSE	C 350 CDI	OM 642.834	3	06.2011-		710095D▲	V
C-KLASSE	C 350 CDI	OM 642.830 OM 642.832 OM 642.834	3	10.2009-		710164D▲	V
CLC-KLASSE	CLC 200CDI CLC 220CDI	OM 646	2,1	05.2005-		7389D	V
CLK-KLASSE	CLK 220CDI	OM 646	2,1	01.2005-		7389D	V
CLK-KLASSE	CLK 320CDI	OM 642	3	01.2005-		7527D	V
CLS-KLASSE	320 CDI	OM 642.910/920 OM 642.920	3	01.2005-	Excl. Japan + USA	7527D	V
					Japan + USA	7645D	V
CLS-KLASSE	350 CDI	OM 642.920	3	04.2009-12.2010	Excl. Japan + USA	7527D	V
					Japan + USA	7645D	V
CLS-KLASSE	350 CDI	OM 642.853 OM 642.854	3	09.2011-		710095D▲	V
CLS-KLASSE	350 CDI	OM 642	3	09.2011-		710164D▲	V
E-KLASSE	E 200 CDI	OM 646	2,1	07.2002-		7389D	V
E-KLASSE	E 200 CDI	OM 646.820	2,1	04.2006-		7625D	V
E-KLASSE	E 220 CDI	OM 646	2,1	03.2002-		7389D	V
E-KLASSE	E 220 CDI	OM 646.821	2,1	04.2006-		7625D	V
E-KLASSE	E 270 CDI	OM 647	2,7	03.2002-		7353D	V
E-KLASSE	E 320 CDI	OM 648	3,2	11.2002-	Excl. USA	7353D	V
E-KLASSE	E 280 CDI	OM 648.961	3,2	05.2004-	Excl. USA	7353D	V
E-KLASSE	E 280 CDI	OM 642.920	3	03.2005-	Excl. Japan + USA	7527D	V
					Japan + USA	7645D	V
E-KLASSE	E 280 CDI	OM 642.921	3	03.2005-	Excl. Japan + USA	7527D	V
E-KLASSE	E 300 CDI	OM 642.850	3	11.2009-	Japan + USA	710095D▲	V
E-KLASSE- BLUETEC	E 300 CDI	OM 642.920	3	09.2007-	Excl. Japan + USA	7527D	V
					Japan + USA	7645D	V
E-KLASSE- BLUETEC	E 300 CDI	OM 642.850 OM 642.852	3	03.2011-	Japan + USA	710095D▲	V
E-KLASSE	E 300 CDI	OM 642.850 OM 642.852	3	11.2009-		710164D▲	V
E-KLASSE	E 320 CDI	OM 642.920	3	03.2005-	Excl. Japan + USA	7527D	V
					Japan + USA	7645D	V
	E 320 CDI	OM 642.910	3	03.2005-	Excl. USA	7527D	V
E-KLASSE	E 350 CDI	OM 642.836 OM 642.850 OM 642.856	3	01.2009-	Japan + USA	710095D▲	V
E-KLASSE	E 350 CDI	OM 642.838 OM 642.852 OM 642.858	3	03.2011-		710095D▲	V
E-KLASSE	E 350 CDI	OM 642	3	01.2009-		710164D▲	V
E-KLASSE	E 400 CDI	OM 628	4	02.2003-		7396D	V
E-KLASSE	E 420 CDI	OM 629	4	01.2006-	rechts / right links / left	7556D	V
						7557D	V
G-KLASSE	G 290 TD	OM 602	2,9	07.1997-		7159D 60375D	V L
G-KLASSE	G 280 CDI	OM 642.884	3	04.2009-		710471D▲	V
G-KLASSE	G 300 CDI	OM 642.884	3	04.2010-		710471D▲	V
G-KLASSE	G 320 CDI	OM 642	3	09.2006-		7645D	V
G-KLASSE	G 350 CDI	OM 642.886	3	07.2011-		710164D▲	V

# MERCEDES-BENZ

	Typ	Engine	Ltr.	Year	Restriction*	Article	Typ
G-KLASSE	G 400 CDI	OM 628	4	12.2000-	Motor Nr. / Engine no. →40026622 zusätzlich benötigte Artikel / extra items required A 628 203 18 82 (Leitung / pipe) A 628 203 19 82 (Leitung / pipe)	<b>7396D</b>	<b>V</b>
					Motor Nr. / Engine no. 40026623→	<b>7396D</b>	<b>V</b>
GL-KLASSE	GL 320 CDI	OM 642.940	3	09.2006-05.2009	Excl. Japan + USA	<b>7527D</b>	<b>V</b>
	GL 350 CDI	OM 642.940	3	05.2009-	Japan + USA	<b>7645D</b>	<b>V</b>
GL-KLASSE	GL 420 CDI	OM 629.912	4	09.2006-05.2009	rechts / right	<b>7556D</b>	<b>V</b>
					links / left	<b>7557D</b>	<b>V</b>
	GL 450 CDI	OM 629.912	4	05.2009-	rechts / right	<b>7556D</b>	<b>V</b>
					links / left	<b>7557D</b>	<b>V</b>
GL-KLASSE	GL 350 CDI	OM 642.820	3	12.2009-		<b>710095D▲</b>	<b>V</b>
GL-KLASSE	GL 350 CDI	OM 642.822	3	10.2010-	Japan + USA	<b>710095D▲</b>	<b>V</b>
GL-KLASSE	GL 350 CDI	OM 642	3	12.2009-		<b>710164D▲</b>	<b>V</b>
GLK-KLASSE	GLK 320CDI	OM 642	3	06.2008-	Excl. USA	<b>7527D</b>	<b>V</b>
GLK-KLASSE	GLK 350CDI	OM 642.832	3	07.2009-01.2010	Japan + USA	<b>710095D▲</b>	<b>V</b>
GLK-KLASSE	GLK 350CDI	OM 642.835	3	07.2012-		<b>710095D▲</b>	<b>V</b>
GLK-KLASSE	GLK 350CDI	OM 642	3	07.2009-		<b>710164D▲</b>	<b>V</b>
M-KLASSE	ML 400 CDI	OM 628	4	09.2001-06.2005	Motor Nr. / Engine no. →40026622 zusätzlich benötigte Artikel / extra items required A 628 203 18 82 (pipe) A 628 203 19 82 (pipe)	<b>7396D</b>	<b>V</b>
					Motor Nr. / Engine no. 40026623→	<b>7396D</b>	<b>V</b>
M-KLASSE	ML 280 CDI	OM 642.940	3	07.2005-07.2009	Excl. Japan + USA	<b>7527D</b>	<b>V</b>
	ML 320 CDI				Japan + USA	<b>7645D</b>	<b>V</b>
	ML 300 CDI	OM 642.940	3	07.2009-	Excl. Japan + USA	<b>7527D</b>	<b>V</b>
	ML 350 CDI				Japan + USA	<b>7645D</b>	<b>V</b>
M-KLASSE	ML 420 CDI	OM 629.912	4	02.2006-09-2009	rechts / right	<b>7556D</b>	<b>V</b>
					links / left	<b>7557D</b>	<b>V</b>
	ML 450 CDI	OM 629.912	4	09.2009-	rechts / right	<b>7556D</b>	<b>V</b>
					links / left	<b>7557D</b>	<b>V</b>
ML-KLASSE	ML 300 CDI	OM 642.820 OM 642.832	3	02.2010-	Japan + USA	<b>710095D▲</b>	<b>V</b>
ML-KLASSE	ML 300 CDI	OM 642.820 OM 642.832	3	02.2010-	Japan + USA	<b>710164D</b>	<b>V</b>
ML-KLASSE	ML 350 CDI	OM 642.820	3	09.2009-	Japan + USA	<b>710164D</b>	<b>V</b>
ML-KLASSE	ML 350 CDI	OM 642.826	3	06.2011-	Japan + USA	<b>710164D</b>	<b>V</b>

## MERCEDES-BENZ

	Type	Engine	Ltr.	Year	Restriction*	Article	Type
R-KLASSE	R 280 CDI	OM 642.950	3	05.2006-	Excl. USA	7527D	V
	R 300 CDI		3	07.2009-	Excl. USA	7527D	V
	R 320 CDI		3	01.2006-	Excl. USA	7527D	V
	R 350 CDI		3	07.2009-	Excl. USA	7527D	V
R-KLASSE	R 280 CDI	OM 642.870 OM 642.872	3	05.2006-		710095D▲	V
R-KLASSE	R 280 CDI	OM 642.870 OM 642.872	3	05.2006-		710164D▲	V
R-KLASSE	R 300 CDI	OM 642.870 OM 642.872	3	07.2009-	Japan+USA	710095D▲	V
R-KLASSE	R 300 CDI	OM 642.870 OM 642.872	3	07.2009-		710164D▲	V
R-KLASSE	R 320 CDI	OM 642.870 OM 642.950	3	01.2006-	Japan + USA	710095D▲	V
R-KLASSE	R 320 CDI	OM 642.870	3	01.2006-		710164D▲	V
R-KLASSE	R 350 CDI	OM 642.872	3	08.2010-		710095D▲	V
R-KLASSE	R 350 CDI	OM 642.870 OM 642.872	3	01.2006-		710164D▲	V
S-KLASSE	S 320 CDI	OM 648	3,2	09.2002-08.2005		7353D	V
S-KLASSE	S 350 CDI	OM 642.868	3	04.2011-	USA	710164D▲	V
S-KLASSE- BLUETEC	S 350 CDI	OM 642.862 OM 642.868	3	04.2011-		710095D▲	V
S-KLASSE- BLUETEC	S 350 CDI	OM 642.861 OM 642.867	3	05.2013-	USA + Kanada	710164D▲	V
S-KLASSE	S 320 CDI	OM 642.930	3	12.2005-	Excl. Japan + USA	7527D	V
					Japan + USA	7645D	V
	S 350 CDI	OM 642.930	3	10.2006-	Excl. Japan + USA Japan + USA	7527D 7645D	V V
S-KLASSE	S 400 CDI	OM 628	4	06.2000-08.2005	Motor Nr. / Engine no. →40026622 zusätzlich benötigte Artikel / extra items required A 628 203 18 82 (pipe) A 628 203 19 82 (pipe)	7396D	V
					Motor Nr. / Engine no. 40026623→		V
S-KLASSE	S 420 CDI	OM 629.911	4	10.2006-	rechts / right links / left	7556D 7557D	V V
SPRINTER	210 D	OM 602	2,9	02.1995-04.2000		7159D	V
	212 D						
	310 D					60375D	L
	312 D						
SPRINTER	410 D	OM 602	2,9	02.1995-05.2006		7159D	V
	412 D					60375D	L

# MERCEDES-BENZ

	Typ	Engine	Ltr.	Year	Restriction*	Article	Typ
SPRINTER	208 CDI 308 CDI 408 CDI	OM 611	2,1	04.2000-05.2006	für OE-Nr. / for OE-no. 611 090 03 54 und / and 611 090 09 54	<b>7206D</b>	<b>V</b>
					Motor Nr. / Engine no. →611987 50030772 für OE-Nr. / for OE-No. 611 090 02 54	<b>7220D</b>	<b>V</b>
						<b>60595D</b>	<b>L</b>
SPRINTER	211 CDI 311 CDI 411 CDI	OM 611	2,1	04.2000-05.2006	für OE-Nr / for OE-No. 611 090 03 54 und / and 611 090 09 54	<b>7206D</b>	<b>V</b>
					Motor Nr. / Engine no. →611987 50030772 für OE-Nr. / for OE-No. 611 090 02 54	<b>7220D</b>	<b>V</b>
						<b>60595D</b>	<b>L</b>
SPRINTER	209 CDI 211 CDI 213 CDI 309 CDI 311 CDI 313 CDI 509 CDI 511 CDI 513 CDI	OM 646	2,1	06.2006-		<b>7610D</b>	<b>V</b>
SPRINTER	213 CDI 313 CDI 413 CDI	OM 611	2,1	04.2000-05.2006	für OE-Nr. / for OE-No. 611 090 03 54 und / and 611 090 09 54	<b>7206D</b>	<b>V</b>
					Motor Nr. / Engine no. →611987 50030772 für OE-Nr. / for OE-No. 611 090 02 54	<b>7220D</b>	<b>V</b>
						<b>60595D</b>	<b>L</b>
SPRINTER	216 CDI 316 CDI 416 CDI	OM 612	2,7	04.2000-05.2006		<b>7256D</b>	<b>V</b>

## MERCEDES-BENZ

	Type	Engine	Ltr.	Year	Restriction*	Article	Type
SPRINTER	218 CDI 219 CDI 318 CDI 319 CDI 418 CDI 419 CDI 518 CDI 519 CDI	OM 642.896	3	06.2006-		710471D▲	V
SPRINTER	319 CDI 419 CDI 519 CDI	OM 642.898	3	03.2009-		710471D▲	V
SPRINTER	218 CDI 318 CDI 518 CDI	OM 642.992	3	06.2006-		710476D	V
UNIMOG	U 100 L	OM 602	2,9	07.1996-12.2002		7159D 60375D	V L
UNIMOG	U 90	OM 602	2,9	07.1996-12.2002		7159D 60375D	V L
V-KLASSE	V 200 CDI	OM 611	2,1	03.1999-07.2003	für OE-Nr. / for OE-No. 611 090 03 54 und / and 611 090 09 54  Motor Nr./ Engine no. →611987 50030772 für OE-Nr. / for OE-No. 611 090 02 54	7206D   7220D   60595D	V   V   L
V-KLASSE	V 220 CDI	OM 611	2,1	09.1996-07.2003	für OE-Nr. / for OE-No. 611 090 03 54 und / and 611 090 09 54  Motor Nr. / Engine no. →611987 50030772 für OE-Nr. / for OE-No. 611 090 02 54	7206D   7220D   60595D	V   V   L
V-KLASSE	V 230 TD	OM 601	2,2	09.1996-07.2003		7159D  60375D	V  L
VANEO	1.7 CDI	OM 668	1,7	02.2002-		7234D	V
VARIO	512 D 612 D 812 D O 812	OM 602	2,9	09.1996-		7159D	V
VIANO	CDI 2.0 CDI 2.2	OM 646.982	2,1	09.2003-		7353D	V
VIANO	3.0 CDI 120 CDI	OM 646.990	3	03.2006-		710476D	V



**MERCEDES-BENZ**

	Typ	Engine	Ltr.	Year	Restriction*	Article	Typ
VITO	110 D 110 TD	OM 601	2,3	02.1996-07.2003		<b>7159D</b>	<b>V</b>
						<b>60375D</b>	<b>L</b>
VITO	108 CDI 110 CDI 112 CDI	OM 611	2,1	03.1999-07.2003	für OE-Nr. / for OE-No. 611 090 03 54 und / and 611 090 09 54	<b>7206D</b>	<b>V</b>
					Motor Nr. / Engine no. →611987 50030772 für OE-Nr. / for OE-No. 611 090 02 54	<b>7220D</b>	<b>V</b>
						<b>60595D</b>	<b>L</b>
VITO	109 CDI 111 CDI 115 CDI	OM 646.983 OM 646.982	2,1	09.2003-		<b>7353D</b>	<b>V</b>
VITO	109 CDI 2.2	OM 646.981	2,1	08.2006-		<b>710023D</b>	<b>V</b>
VITO	120 CDI	OM 642.990	3	09.2007-		<b>710476D</b>	<b>V</b>
VITO	122 CDI	OM 642.890	3	09.2010-		<b>710095D ▲</b>	<b>V</b>

**MULTICAR**

FUMO	3	F1CE 0481	3			<b>7631D</b> <b>7523D</b>	<b>V</b> <b>D</b>
TREMO	CARRIER CARRIER S	AVM	1,9			<b>7283D</b> <b>710612 ▲</b>	<b>V</b> <b>A</b>

**OPEL**

ASTRA F	2.0 DI	X 20 DTL	2	03.1998-08.2000	Pneumatisch, Metalldeckel / Pneumatic, Metal cover	<b>7188D</b>	<b>V</b>
ASTRA F	2.0 DI	X 20 DTL	2	03.1998-08.2000	Pneumatisch, Kunststoffdeckel schwarz / Pneumatic, Plastic cover black	<b>7211D</b>	<b>V</b>
ASTRA F	2.0 DTI	X 20 DTH	2	08.1999-08.2000	Pneumatisch, Metalldeckel / Pneumatic, Metal cover	<b>7188D</b>	<b>V</b>
ASTRA F	2.0 DTI	X 20 DTH	2	08.1999-08.2000	Pneumatisch, Kunststoffdeckel schwarz / Pneumatic, Plastic cover black	<b>7211D</b>	<b>V</b>
ASTRA F	2.0 DTI	X 20 DTH	2	08.1999-08.2000	Elektrisch - Electric	<b>7375D</b>	<b>V</b>
ASTRA G	2.0 DI	Y 20 DTL X 20 DTL	2	02.1998-04.2005	Pneumatisch, Metalldeckel / Metal cover	<b>7188D</b>	<b>V</b>
ASTRA G	2.0 DI	Y 20 DTL  X 20 DTL	2	02.1998-04.2005	Pneumatisch, Kunststoffdeckel schwarz / Pneumatic, Plastic cover black	<b>7211D</b>	<b>V</b>

OPEL	Type	Engine	Ltr.	Year	Restriction*	Article	Type
ASTRA G	2.0 DTI 16V	Y 20 DTH X 20 DTH	2	08.1999-01.2005	Pneumatisch, Metalldeckel / Pneumatic, Metal cover	7188D	V
ASTRA G	2.0 DTI 16V	Y 20 DTH X 20 DTH	2	08.1999-01.2005	Pneumatisch, Kunststoffdeckel schwarz / Pneumatic, Plastic cover black	7211D	V
ASTRA G	2.0 DTI 16V	Y 20 DTH X 20 DTH	2	08.1999-01.2005	Elektrisch - Electric	7375D	V
ASTRA G	2.2 DTI	Y 22 DTR	2,2	09.2002-10.2005		7375D	V
FRONTERA B	2.2 DTI	Y 22 DTH	2,2	09.2002-	Pneumatisch, Metalldeckel / Pneumatic, Metal cover	7188D	V
FRONTERA B	2.2 DTI	Y 22 DTH	2,2	09.2002-	Elektrisch - Electric	7375D	V
FRONTERA B	2.2 DTI	X 22 DTH Y 22 DTH	2,2	10.1998-09.2002	Chassis →2V 599999 Chassis 3V 500001→	7188D 7375D	V V
OMEGA B	2.0 DTI 16 V	X 20 DTH	2	09.1997-09.2000	Metalldeckel - Metal cover	7188D	V
OMEGA B	2.0 DTI 16 V	X 20 DTH	2	09.1997-09.2000	Pneumatisch, Kunststoffdeckel schwarz / Pneumatic, Plastic cover black	7211D	V
OMEGA B	2.2 DTI 16 V	Y 22 DTH	2,2	09.2000-07.2003	Metalldeckel - Metal cover	7188D	V
OMEGA B	2.2 DTI 16 V	Y 22 DTH	2,2	09.2000-07.2003	Pneumatisch, Kunststoffdeckel schwarz / Pneumatic, Plastic cover black	7211D	V
SIGNUM	2.0 DTI	Y 20 DTH	2	05.2003-		7375D	V
SIGNUM	2.2 DTI 16V	Y 22 DTR	2,2	05.2003-		7375D	V
SINTRA	2.2 DTI	X 22 DTH	2,2	07.1997-04.1999		7188D	V
VECTRA B	2.0 DI 16V	X 20 DTL	2	11.1996-04.2002	Pneumatisch, Kunststoffdeckel schwarz / Pneumatic, Plastic cover black	7211D	V
VECTRA B	2.0 DI 16V	X 20 DTL	2	11.1996-04.2002	Metalldeckel / Metal cover	7188D	V
VECTRA B	2.0 DTI 16V	X 20 DTH Y 20 DTH	2	06.1997-07.2003	Pneumatisch, Kunststoffdeckel schwarz / Pneumatic, Plastic cover black	7211D	V
VECTRA B	2.0 DTI 16V	X 20 DTH Y 20 DTH	2	06.1997-07.2003	Metalldeckel / Metal cover	7188D	V
VECTRA B	2.2 DTI 16V	Y 22 DTR	2,2	09.2000-07.2003		7211D	V
VECTRA C	2.0 DTI 2.0 DTI 16V	Y 20 DTH	2	04.2002-		7375D	V
VECTRA C	2.2 DTI 16V	Y 22 DTR	2,2	04.2002-		7375D	V
VECTRA C	2.2 DTI	Y 22 DTR	2,2	10.2003-		7375D	V

**Opel**

Opel	Typ	Engine	Ltr.	Year	Restriction*	Article	Typ
ZAFIRA A	2.0 DI 16V	X 20 DTL	2	10.1999-06.2005	Pneumatisch, Metalldeckel / Pneumatic, Metal cover	<b>7188D</b>	<b>V</b>
ZAFIRA A	2.0 DI 16V	X 20 DTL	2	10.1999-06.2005	Pneumatisch, Kunststoffdeckel schwarz / Pneumatic, Plastic cover black	<b>7211D</b>	<b>V</b>
ZAFIRA A	2.0 DTI 16V	Y 20 DTH	2	09.2000-06.2005		<b>7375D</b>	<b>V</b>
ZAFIRA A	2.2 DTI 16V	Y 22 DTR	2,2	01.2002-06.2005		<b>7375D</b>	<b>V</b>

**PEUGEOT**

BOXER	3.0 D		3	07.2006-		<b>7631D</b> <b>7523D</b>	<b>V</b> <b>D</b>
BOXER	3.0 HDI 160		3	04.2006-		<b>7631D</b> <b>7523D</b>	<b>V</b> <b>D</b>

**PUCH**

G-MODELL (W461)	G 290 TD	OM 602	2,9	07.1997-		<b>7159D</b> <b>60375D</b>	<b>V</b> <b>L</b>
--------------------	----------	--------	-----	----------	--	-------------------------------	----------------------

**SAAB**

9-3	2.2 TID	D 223 L X 22 DTH	2,2	02.1998-11.2000	Pneumatisch, Metalldeckel / Pneumatic, Metal cover	<b>7188D</b>	<b>V</b>
9-3	2.2 TID	D 223 L X 22 DTH	2,2	02.1998-11.2000	Elektrisch / Electric	<b>7375D</b>	<b>V</b>
9-5	2.2 TID	D 223 L	2,2	03.2002-11.2000	Elektrisch - Electric	<b>7375D</b>	<b>V</b>

**SEAT**

ALHAMBRA	1.9 TDI	ASZ	1,9	11.2002-		<b>7372D</b> <b>710558</b>	<b>V</b> <b>A</b>
ALHAMBRA	1.9 TDI	BVK / AUJ	1,9	06.2000-		<b>7372D</b> <b>710558</b>	<b>V</b> <b>A</b>
ALHAMBRA	1.9 TDI	ANU	1,9	06.2000-05.2005		<b>7241D</b> <b>710558</b>	<b>V</b> <b>A</b>
ALHAMBRA	1.9 TDI	BTB	1,9	05.2005-		<b>7241D</b> <b>710558</b>	<b>V</b> <b>A</b>
ALHAMBRA	2.0 TDI	BRT	2	11.2005-		<b>7529D</b>	<b>V</b>
ALTEA	1.9 TDI	BKC / BXE	1,9	04.2004-		<b>7496D</b> <b>61306D</b> <b>61384D</b> <b>710336</b>	<b>V</b> <b>L</b> <b>L</b> <b>A</b>
ALTEA	1.9 TDI	BJB	1,9	04.2004-		<b>7451D</b> <b>710612▲</b>	<b>V</b> <b>A</b>
ALTEA	1.9 TDI	BLS	1,9	04.2004-		<b>710572D▲</b>	<b>V</b>
ALTEA	1.9 TDI	BXF	1,9	08.2009-		<b>7496D</b> <b>61306D</b> <b>61384D</b> <b>710336</b>	<b>V</b> <b>L</b> <b>L</b> <b>A</b>

# EGR

SEAT	Type	Engine	Ltr.	Year	Restriction*	Article	Type
ALTEA	2.0 TDI	AZV	2	03.2004-		7496D 710413	V A
ALTEA	2.0 TDI 16V	BKD	2	03.2004-		7496D 710413	V A
ALTEA	2.0 TDI	BMM	2	11.2005-		710572D▲	V
ALTEA	2.0 TDI	CEGA	2	03.2006-	oben / top	665104D	L
AROSA	1.4 TDI	AMF	1,4	01.2000-06.2004		7293D 710608▲	V A
AROSA	1.7 SDI	AKU	1,7	08.1997-06.2004		710570D	V
CORDOBA	1.4 TDI	AMF	1,4	10.2002-		7293D 710608▲	V A
CORDOBA	1.4 TDI	BNM	1,4	05.2005-		7271D	V
CORDOBA	1.4 TDI	BMS	1,4	06.2005-		710572D▲	V
CORDOBA	1.9 SDI	AQM/ A GP	1,9	06.1999-10.2002		710570D	V
CORDOBA	1.9 SDI	ASY	1,9	09.2002-11.2009		710570D	V
CORDOBA	1.9 TDI / 1.9 D	AGR / ALH / ASV	1,9	06.1999-10.2002		7293D 710608▲	V A
CORDOBA	1.9 TDI	ASZ	1,9	10.2002-		7327D 710612▲	V A
CORDOBA	1.9 TDI	ATD	1,9	08.2002-		7283D 710612▲	V A
CORDOBA	1.9 TDI	AXR	1,9	09.2002-	unten / down	7496D 60777D	V L
CORDOBA	1.9 TDI	BLT	1,9	09.2002-	unten / down	7496D 60777D	V L
CORDOBA	1.9 TDI	BMT	1,9	09.2002-11.2009		710572D▲	V
IBIZA III	1.9 SDI	AQM / AGP	1,9	08.1999-02.2002		710570D	V
IBIZA III	1.9 TDI	AGR / ALH	1,9	08.1999-02.2002		7293D 710608▲	V A
IBIZA III	1.9 TDI	ASV	1,9	08.1999-02.2002		7293D 710608▲	V A
IBIZA IV	1.4 TDI	AMF	1,4	05.2002-12.2005		7293D 710608▲	V A
IBIZA IV	1.4 TDI	BNM / BNV	1,4	05.2005-		7271D	V
IBIZA IV	1.4 TDI	ATD	1,4	02.2002-		7283D 710612▲	V A
IBIZA IV	1.4 TDI	BMS	1,4	06.2005-11.2009		710572D▲	V
IBIZA IV	1.9 SDI	ASY	1,9	02.2002-12.2005		710570D▲	V
IBIZA IV	1.9 TDI	ASZ	1,9	02.2002-	unten / down	7327D 60777D 665574D 710612▲	V L D-S A
IBIZA IV	1.9 TDI	AXR	1,9	02.2002-		7496D	V
IBIZA IV	1.9 TDI	BLT	1,9	02.2002-	unten / down	7496D 60777D 665574D	V L D-S
IBIZA IV	1.9 TDI	BMT	1,9	02.2002-11.2009		710572D▲	V
IBIZA IV Cupra R	1.9 TDI	BPX / BUK	1,9	03.2004-02.2008		7371D 710608▲	V A
IBIZA V	1.4 TDI	BMS	1,4	07.2008-06.2010		710572D▲	V
IBIZA V	1.9 TDI	BXJ BLS	1,9	03.2008-06.2010		710572D▲	V
LEON	1.9 SDI	AQM	1,9	11.1999-06.2006		710570D▲	V
LEON	1.9 TDI	AHF / ASV AGR	1,9	11.1999-06.2006		7293D 710608▲	V A
LEON	1.9 TDI	ALH	1,9	05.2001-06.2006		7293D 710608▲	V A

## SEAT

	Typ	Engine	Ltr.	Year	Restriction*	Article	Typ
LEON	1.9 TDI	ARL	1,9	02.2001-06.2006		7371D 710608▲	V A
LEON	1.9 TDI	ASZ	1,9	05.2003-06.2006		7371D 710608▲	V A
LEON	1.9 TDI	AXR	1,9	10.2005-06.2006	oben / top unten / down	7496D 61306D 61384D 710336 665574D	V L L A D-S
LEON	1.9 TDI	ASV	1,9	10.2005-		7293D 710608▲	V A
LEON	1.9 TDI	BXF	1,9	06.2007-	oben / top unten / down	7496D 61306D 61384D 710336 665574D	V L L A D-S
LEON	1.9 TDI	BKC / BXE	1,9	07.2005-	oben / top unten / down	7496D 61306D 61384D 710336 665574D	V L L A D-S
LEON	1.9 TDI	BLS	1,9	07.2005-		710572D▲	V
LEON	2.0 TDI	AZV	2	07.2005-		7496D 710413	V A
LEON	2.0 TDI 16V	BKD	2	07.2005-		7496D 710413	V A
LEON	2.0 TDI	BMM	2	10.2005-		710572D▲	V
LEON	2.0 TDI	CEGA	2	05.2006-	oben / top	665104D	L
TOLEDO II	1.9 SDI	AQM	1,9	11.2009-06.2004		710570D▲	V
TOLEDO II	1.9 TDI	AHF / ASV	1,9	04.1999-05.2006		7293D 710608▲	V A
TOLEDO II	1.9 TDI	ALH	1,9	04.1999-09.2002		7293D 710608▲	V A
TOLEDO II	1.9 TDI	AGR	1,9	05.2001-05.2006		7293D 710608▲	V A
TOLEDO II	1.9 TDI	ARL / ASZ	1,9	10.2000-10.2005		7371D 710608▲	V A
TOLEDO II	1.9 TDI	AXR	1,9	08.2005-05.2006	oben / top unten / down	7496D 61306D 61384D 710336 665574D	V L L A D-S
TOLEDO III	1.9 TDI	BJB	1,9	10.2004-		7451D 710612▲ 710336	V A A
TOLEDO III	1.9 TDI	BKC / BXE	1,9	10.2004-	oben / top unten / down	7496D 61306D 61384D 710336 665574D	V L L A D-S
TOLEDO III	1.9 TDI	BLS	1,9	10.2004-05.2009		710572D▲	V
TOLEDO III	2.0 TDI 16V	BKD	2	10.2004-05.2009		7496D 710413	V A
TOLEDO III	2.0 TDI	AZV	2	10.2004-05.2009		7496D 710413	V A
TOLEDO III	2.0 TDI	BMM	2	11.2005-05.2009		710572D▲	V

# EGR

SKODA	Type	Engine	Ltr.	Year	Restriction*	Article	Type
FABIA	1.4 TDI	AMF	1,4	04.2003-03.2008		7293D 710608▲	V A
FABIA	1.4 TDI	BNV	1,4	10.2005-03.2008		7271D	V
FABIA	1.4 TDI	BNM	1,4	10.2005-		7271D	V
FABIA	1.4 TDI	BMS	1,4	01.2007-		710572D▲	V
FABIA	1.9 SDI	ASY	1,9	11.1999-03.2008		710570D▲	V
FABIA	1.9 TDI RS	ASZ	1,9	06.2003-03.2008		7327D 710612▲	V A
FABIA	1.9 TDI RS	BLT	1,9	08.2005-03.2008		7496D 60777D 665574D	V L D-S
FABIA	1.9 TDI	AXR	1,9	01.2000-03.2008		7496D 60777D 665574D	V L D-S
FABIA	1.9 TDI	ATD	1,9	03.2008-		7283D 710612▲	V A
FABIA	1.9 TDI	BSW	1,9	04.2007- unten		7496D 60777D	V L
FABIA	1.9 TDI	BLS	1,9	04.2007-		710572D▲	V
OCTAVIA	1.9 SDI	AQM / AGP	1,9	06.1997-12.2003		710570D▲	V
OCTAVIA	1.9 TDI	AGR / AHF ALH / ASV / ATD	1,9	08.1997-03.2003	Chassis →1U-3-768 637 →1U3A016 277 →1U-38696 292	7293D 710608▲	V A
OCTAVIA	1.9 TDI	AGR / AHF / ALH / ASV / ATD	1,9	03.2003-	Chassis 1U-3-768 638→ 1U3A016 278→ 1U-38696 292→	7283D 710612▲	V A
OCTAVIA	1.9 TDI	ASZ	1,9	01.2003-09.2004		7371D 710608▲	V A
OCTAVIA	1.9 TDI	AXR	1,9	06.2004-	oben / top unten / down	7496D 61306D 61384D 665574D	V L L D-S
OCTAVIA	1.9 TDI	BKC / BXE	1,9	06.2004-	oben / top unten / down	7496D 61306D 61384D 710336 665574D	V L L A D-S
OCTAVIA	1.9 TDI	BJB	1,9	06.2004-		7451D 710612▲	V A
OCTAVIA	1.9 TDI	BLS	1,9	06.2004-12.2010		710572D▲	V
OCTAVIA	2.0 TDI 16V	BKD	2	02.2004-		7496D 710413	A A
OCTAVIA	2.0 TDI 2.0 TDI 16V	AZV	2	02.2004-		7496D 710413	V A
OCTAVIA	2.0 TDI	BMM	2	11.2005-		710572D▲	V
OCTAVIA	2.0 TDI	CEGA	2	04.2006-	oben / top	665104D	L
PRAKTIKER	1.4 TDI	BNM	1,4	03.2007-		7271D	V
PRAKTIKER	1.4 TDI	BNV	1,4	03.2007-		7271D	V
ROOMSTER	1.4 TDI	BNM	1,4	07.2006-		7271D	V
ROOMSTER	1.4 TDI	BNV	1,4	09.2006-		7271D	V
ROOMSTER	1.4 TDI	BMS	1,4	09.2006-03.2010		710572D▲	V
ROOMSTER	1.9 TDI	AXR BSW	1,9	09.2006-		7496D 60777D 665574D	V L D-S

## SKODA

	Typ	Engine	Ltr.	Year	Restriction*	Article	Typ
ROOMSTER	1.9 TDI	BLS	1,9	09.2006-03.2010		710572D ▲	V
SUPERB	1.9 TDI	AVB	1,9	08.2002-10.2005	Schaltgetriebe manual gearbox	7241D 60409D	V L
						710558 665574D	A D-S
SUPERB	1.9 TDI	BSV BPZ	1,9	10.2005-03.2008		710571D ▲	V
SUPERB	1.9 TDI	BXE	1,9	03.2008-	oben / top unten / down	7496D 61306D 61384D 710336 665574D	V L L A D-S
SUPERB	1.9 TDI	AWX AVF	1,9	02.2002-03.2008	Chassis →3U-6-122 427 →3U-6A300 646 Schaltgetriebe manual gearbox Automatikgetriebe autom. gearbox oben / top Automatikgetriebe autom. gearbox unten / down	7372D   60633D 60702D  60364D  710558 665574D	V   L L  L  A D-S
SUPERB	1.9 TDI	BLS	1,9	03.2008-		710572D ▲	V
SUPERB	2.0 TDI	BSS	2	10.2005-03.2008		710571D ▲	V
SUPERB	2.0 TDI 16V	BKD	2	01.2009-		7496D 710413	V A
SUPERB	2.0 TDI	BMP	2	03.2008-		710572D ▲	V
SUPERB	2.0 TDI	CBBB	2	07.2008-	oben / top	665104D	L
SUPERB	2.5 TDI	AYM	2,5	02.2002-	oben / top unten / down	60415D 60347D	L L
YETI	2.0 TDI	CBDB / CEGA	2	05.2009-	oben / top	665104D	L

## VAUXHALL

ASTRA MK IV	2.0 DI	Y 20 DTL X 20 DTL	2	02.1998-07.2004	Metal cover	7188D	V
ASTRA MK IV	2.0 DI	Y 20 DTL X 20 DTL	2	09.1998-07.2004	Plastic cover black	7211D	V
ASTRA MK IV	2.0 DTI 16V	Y 20 DTH X 20 DTH	2	08.1999-07.2004	Metal cover	7188D	V
ASTRA MK IV	2.0 DTI 16V	Y 20 DTH X 20 DTH	2	08.1999-07.2004	Plastic cover black	7211D	V
ASTRA MK IV	2.0 DTI 16V	Y 20 DTH X 20 DTH	2	08.1999-07.2004	Electric	7375D	V
ASTRA MK IV	2.0 DTI	Y 20 DTH	2	04.2004-	Metal cover	7188D	V
ASTRA MK IV	2.0 DTI	Y 20 DTH	2	04.2004-	Plastic cover black	7211D	V
ASTRA MK IV	2.0 DTI	Y 20 DTH	2	04.2004-	Electric	7375D	V
FRONTERA MK II	2.2 DTI	X 22 DTH Y 22 DTH	2,2	10.1998-	Chassis →2V599999 Metal cover	7188D Pneumatic	V
FRONTERA MK II	2.2 DTI	X 22 DTH Y 22 DTH	2,2	10.1998-	Chassis 3V500001→	7375D Electric	V
OMEGA	2.0 DTI 16 V	X 20 DTH	2	10.1998-09.2000	Metal cover	7188D	V
OMEGA B	2.0 DTI 16 V	X 20 DTH	2	10.1998-09.2000	Plastic cover black	7211D	V

## VAUXHALL

	Type	Engine	Ltr.	Year	Restriction*	Article	Type
OMEGA	2.2 DTI 16 V	Y 22 DTH	2,2	09.2000-07.2003	Metal cover	7188D	V
OMEGA	2.2 DTI 16 V	Y 22 DTH	2,2	09.2000-07.2003	Plastic cover black	7211D	V
SIGNUM	2.0 DTI	Y 20 DTH	2	05.2003-		7375D	V
SIGNUM	2.2 DTI	Y 22 DTR	2,2	05.2003-		7375D	V
SINTRA	2.2 DTI	X 22 DTH	2,2	07.1997-04.1999		7188D	V
VECTRA	2.0 DI 16V	X 20 DTL	2	11.1996-04.2002	Plastic cover black	7211D	V
VECTRA	2.0 DI 16V	X 20 DTL	2	11.1996-04.2002	Metal cover	7188D	V
VECTRA	2.0 DTI 16V	X 20 DTH Y 20 DTH	2	06.1997-04.2002	Plastic cover black	7211D	V
VECTRA	2.0 DTI 16V	X 20 DTH Y 20 DTH	2	06.1997-04.2002	Metal cover	7188D	V
VECTRA	2.2 DTI 16V	Y 22 DTR	2,2	09.2000-04.2002		7211D	V
VECTRA MK II	2.0 DTI 16V	Y 20 DTH	2	04.2002-		7375D	V
VECTRA MK II	2.2 DTI 16V	Y 22 DTR	2,2	04.2002-		7375D	V
ZAFIRA	2.0 DI 16V	X 20 DTL	2	10.1999-06.2005	Pneumatic, Metal cover	7188D	V
ZAFIRA	2.0 DI 16V	X 20 DTL	2	10.1999-06.2005	Pneumatic, Plastic cover black	7211D	V
ZAFIRA	2.0 DTI 16V	Y 20 DTH	2	04.1999-		7375D	V
ZAFIRA	2.2 D	Y 22 DTR	2,2	06.2001-06.2005		7375D	V

## VOLKSWAGEN

BORA	1.9 SDI	AGP/AQM	1,9	10.1998-05.2005		710570D▲	V
BORA	1.9 TDI	AGR / AHF AJM / ALH ASV / AUY	1,9	10.1998-06.2001		7293D 710608▲	V A
BORA	1.9 TDI	ATD	1,9	09.2000-05.2005		7293D 710608▲	V A
BORA	1.9 TDI	ARL / ASZ	1,9	05.2000-05.2005		7371D 710608▲	V A
BORA	1.9 TDI	AXR	1,9	05.2000-05.2005	oben / top unten / down	7496D 61306D 61384D 710336 665574D	V L L A D-S
CRAFTER	2.5 TDI	BJJ/CEBA BJK/CEBB BJL/CECA BJM/CECB	2,5	04.2006-		710575D▲	V
CADDY II	1.9 SDI	AYQ / AEY	1,9	11.1995-01.2004		710570D▲	V
CADDY II	1.9 TDI	ALH / ALE / AHU	1,9	10.1996-01.2004		7293D 710608▲	V A
CADDY III	1.9 TDI	BJB	1,9	04.2004-		7451D 710612▲	V A
CADDY III	1.9 TDI	BSU BLS	1,9	04.2004-08.2010		710572D▲	V
CADDY III	2.0 TDI	BST / BDY	2	03.2004-08.2010		710570D▲	V
CADDY III	2.0 TDI	BMM	2	09.2007-08.2010		710572D▲	V
EOS	2.0 TDI	BMM	2	06.2006-05.2008		710572D▲	V
EOS	2.0 TDI 16V	CBAB	2	05.2008-	oben / top	665104D	L
FOX	1.4 TDI	BNM	1,4	04.2005-		7271D	V
FOX	1.9 SDI	ASY	1,9	12.2007-		710570D▲	V
GOLF IV	1.9 SDI	AGP/AQM	1,9	08.1997-06.2006		710570D▲	V
GOLF IV	1.9 TDI	AHF / ALH ASV	1,9	08.1997-05.2006		7293D 710608▲	V A
GOLF IV	1.9 TDI	AGR	1,9	10.1997-	Chassis 1J-X-000001→	7293D 710608▲	V A



## VOLKSWAGEN

	Typ	Engine	Ltr.	Year	Restriction*	Article	Typ
GOLF IV	1.9 TDI	AJM / AUY	1,9	12.1998-06.2001		7293D 710608▲	V A
GOLF IV	1.9 TDI	ARL / ASZ	1,9	05.2000-06.2005		7371D 710608▲	V A
GOLF IV	1.9 TDI	ATD	1,9	09.2000-06.2006		7293D 710608▲	V A
GOLF IV	1.9 TDI	AXR	1,9	09.2000-06.2006	oben / top unten / down	7496D 61306D 61384D 710336 665574D	V L L A D-S
GOLF V	1.9 TDI	BRU / BKC / BXE / BXF	1,9	10.2003-	oben / top unten / down	7496D 61306D 61384D 710336	V L L A
GOLF V	1.9 TDI	BXJ BLS	1,9	10.2003-		710572D▲	V
GOLF V	2.0 TDI	AZV	2	10.2003-	oben / top	7496D 665104D 710413 665574D	V L A D-S
GOLF V	2.0 TDI 16V	BKD	2	10.2003-		7496D 710413	V A
GOLF V	2.0 TDI	CBDA CBDB	2	01.2005-	oben / top	665104D	L
GOLF V	2.0 TDI	BMM	2	06.2007-		710572D▲	V
GOLF PLUS	1.9 TDI	BKC / BXE BRU / BXF	1,9	05.2005-	oben / top unten / down	7496D 61306D 61384D 710336 665574D	V L L A D-S
GOLF PLUS	1.9 TDI	BXJ BLS	1,9	05.2005-01.2009		710572D▲	V
GOLF PLUS	2.0 TDI	AZV	2	05.2005-	oben / top	7496D 665104D 710413 665574D	V L A D-S
GOLF PLUS	2.0 TDI	CBDA CBDB CBDC	2	01.2005-	oben / top	665104D	L
GOLF PLUS	2.0 TDI	BEE	2	05.2005-		7496D 710413	V A
GOLF PLUS	2.0 TDI 16V	BKD	2	01.2005-	oben / top	7496D 665104D 710413 665574D	V L A D-S
GOLF PLUS	2.0 TDI	BMM	2	12.2005-05.2009		710572D▲	V
GOLF VI	2.0 TDI	CBAA CBAB CBBB CBDC	2	10.2008-	oben / top	665104D	L
GOLF VI	2.0 TDI	BMM	2	07.2009-		710572D▲	V

## VOLKSWAGEN

	Type	Engine	Ltr.	Year	Restriction*	Article	Type
JETTA III	1.9 TDI	BKC BXE	1,9	08.2005-		7496D	V
					oben / top unten / down	61306D 61384D 710336 665574D	L L A D-S
JETTA III	1.9 TDI	BLS	1,9	08.2005-10.2010		710572D▲	V
JETTA III	2.0 TDI	AZV	2	09.2005-		7496D 665104D 710413 665574D	V L A D-S
JETTA III	2.0 TDI 16V	BKD	2	08.2005-	oben / top	7496D 665104D 710413 665574D	V L A D-S
JETTA III	2.0 TDI	CBDA / CBDB	2	09.2005-	oben / top	665104D	L
JETTA III	2.0 TDI	CEGA	2	10.2006-	oben / top	665104D	L
JETTA III	2.0 TDI	BMM	2	10.2005-10.2010		710572D▲	V
LT 28 – 46	2.5 TDI	AHD	2,5	05.1999-	Chassis 2D-Y-000 002→	7223D 710608▲	V A
LT 28 – 46	2.5 TDI	ANJ / APA AVR / BBE BBF	2,5	05.1999-07.2006		7223D 710608▲	V A
LUPO	1.2 TDI	ANY	1,2	07.1999-07.2005		7293D 710608▲	V A
LUPO	1.2 TDI	AYZ	1,2	07.1999-07.2005		7496D	V
LUPO	1.4 TDI	AMF	1,4	05.1999-07.2005	Linkslenker / Lefthand	7293D 710608▲	V A
LUPO	1.4 TDI	AMF	1,4	05.1999-07.2005	Rechtslenker / Righthand	7301D	V
LUPO	1.7 SDI	AKU	1,7	09.1998-07.2005		710570D▲	V
MULTIVAN T5	1.9 TDI	AXB	1,9	04.2003-		7372D 710558	V A
MULTIVAN T5	1.9 TDI	BRR BRS	1,9	06.2006-11.2009		710571D▲	V
MULTIVAN T5	2.5 TDI	AXD / AXE / BLJ	2,5	04.2003-		7649D 710608▲	V A
MULTIVAN T5	2.5 TDI	BNZ BPC	2,5	04.2003-		710575D▲	V
NEW BEETLE	1.9 TDI	ALH	1,9	01.1998-06.2004		7293D 710608▲	V A
NEW BEETLE	1.9 TDI	BEW	1,9	02.2001-		710571D▲	V
NEW BEETLE	1.9 TDI	AXR	1,9	06.2003-	unten / down	7496D 61384D 710336 665574D	V L A D-S
NEW BEETLE	1.9 TDI	BEW	1,9	02.2001-	oben / top unten / down	61306D 61384D 710336	L L A
NEW BEETLE	1.9 TDI	BSW	1,9	07.2005-	oben / top unten / down	7496D 61306D 61384D 710336 665574D	V L L A D-S
NEW BEETLE	1.9 TDI	ATD	1,9	02.2001-		7294D 710614▲	V A
NEW BEETLE	1.9 TDI	BEW	1,9	02.2001-	oben	61010D▲	L

# VOLKSWAGEN

	Typ	Engine	Ltr.	Year	Restriction*	Article	Typ
PASSAT	1.9 TDI	ATJ AJM	1,9	08.1998-11.2000		7241D	V
						710558	A
					Schaltgetriebe manual gearbox	60409D	L
					Automatikgetriebe autom. gearbox	60700D	L
					oben / top		
Automatikgetriebe autom. gearbox	60364D	L					
					unten / down	665574D	D-S
PASSAT	1.9 TDI	AVB	1,9	02.2000-05.2005		7241D	V
						710558	A
					Schaltgetriebe manual gearbox	60409D	L
					Automatikgetriebe autom. gearbox	60700D	L
					oben / top		
Automatikgetriebe autom. gearbox	60364D	L					
					unten / down	665574D	D-S
PASSAT	1.9 TDI	AVF AWX	1,9	11.2000-05.2005		7372D	V
						710558	A
					Schaltgetriebe manual gearbox	60633D	L
					Automatikgetriebe autom. gearbox	60702D	L
					oben / top		
Automatikgetriebe autom. gearbox	60364D	L					
					unten / down	665574D	D-S
PASSAT	1.9 TDI	BKC / BXE	1,9	03.2005-		7496D	V
					oben / top	61306D	L
					unten / down	61384D	L
						710336	A
					665574D	D-S	
PASSAT	1.9 TDI	BLS	1,9	03.2005-11.2008		710572D ▲	V
PASSAT	1.9 TDI	BRR BRS	1,9	06.2006-11.2009		710571D ▲	V
PASSAT	2.0 TDI	BGW / BHW	2	12.2003-05.2005		710571D ▲	V
PASSAT	2.0 TDI	BMA / BVE / BWV	2	03.2005-	Chassis	7496D	V
					→3C-6-105 500		
					→3C-6E121 500		
					710413	A	
PASSAT	2.0 TDI 16V	BKP	2	03.2005-	Chassis	7496D	V
					→3C-6-105 500		
					→3C-6E121 500		
					710413	A	
PASSAT	2.0 TDI	CBAA CBAC CBBB CBDC	2	06.2008-	oben / top	665104D	L

## VOLKSWAGEN

	Type	Engine	Ltr.	Year	Restriction*	Article	Type
PASSAT	2.0 TDI 16V	CBAB CBBB	2	03.2005-	oben / top	665104D	L
PASSAT	2.0 TDI	BGW BHW	2	12.2003-	unten / down	60364D	L
PASSAT	2.5 TDI	AKN AFB BAU	2,5	07.1998- 01.2003-	oben / top unten / down	60415D 60347D	L L
PASSAT	2.0 TDI	BMP	2	03.2005-		710572D▲	V
PASSAT CC	2.0 TDI	CBAA CBAB CBAC CBBB	2	06.2008-	oben / top	665104D	L
PHAETON	5.0 V10 TDI	AJS	5	11.2002-	Linke + rechte Seite Left + right side	7268D	V
POLO	1.4 TDI	BAY BNM BNV	1,4	10.2001- 04.2005-		7271D	V
POLO	1.4 TDI	AMF	1,4	10.1999-06.2005		7293D 710608▲	V A
POLO	1.4 TDI	BWB BMS	1,4	04.2005-11.2009		710572D▲	V
POLO	1.7 SDI	AKU AKW	1,7	07.1997-09.2001		710570D▲	V
POLO	1.9 SDI	AGP/AQM ASX/AGD	1,9	08.1999-01.2002		710570D▲	V
POLO	1.9 TDI	AGR / ALH / ASV	1,9	09.1996-09.2001		7293D 710608▲	V A
POLO	1.9 TDI	ATD	1,9	10.2001-		7283D 710612▲	V A
POLO	1.9 TDI	AXR BLT	1,9	10.2001-		7496D 60777D	V L
POLO	1.9 TDI	ASZ	1,9	11.2003-		7327D 710612▲	V A
POLO	1.9 TDI	BMT	1,9	10.2001-11.2009		710572D▲	V
POLO	1.9 TDI	ASY	1,9	10.2001-11.2009		710570D▲	V
SCIROCCO	2.0 TDI	CBBB CBDB	2	09.2008-	oben / top	665104D	L
SHARAN	1.9 TDI	ANU	1,9	09.1995-		7241D 710558	V A
SHARAN	1.9 TDI	AUY / ASZ BTB / BVK	1,9	04.2000-		7372D 710558	V A
SHARAN	2.0 TDI	BRT	2	11.2005-		7529D	V
TIGUAN	2.0 TDI	CBAA CBAB CBBB	2	09.2007-	oben / top	665104D	L
TOUAREG	2.5 R5 TDI	BAC / BPE / BLK	2,5	01.2003-		7650D 710613▲	V A
TOUAREG	2.5 R5 TDI	BPD BPE	2,5	08.2003-05.2010		710575D▲	V
TOUAREG	5.0 V10 TDI	AYH	5	10.2002-	Linke + rechte Seite Left + right side	7268D	V

## VOLKSWAGEN

VOLKSWAGEN	Typ	Engine	Ltr.	Year	Restriction*	Article	Typ
TOURAN	1.9 TDI	AVQ / BKC BRU / BXE / BXF	1,9	02.2003-		<b>7496D</b>	V
					oben / top unten / down	<b>61306D</b> <b>61384D</b> <b>710336</b> <b>665574D</b>	L L A D-S
TOURAN	1.9 TDI	BXJ BLS	1,9	08.2003-05.2010		<b>710572D▲</b>	V
TOURAN	2.0 TDI	AZV	2	02.2003-		<b>7496D</b> <b>710413</b>	V A
TOURAN	2.0 TDI 16V	BKD	2	08.2003-		<b>7496D</b> <b>710413</b>	V A
TOURAN	2.0 TDI	BMM	2	12.2005-05.2010		<b>710572D▲</b>	V
T4	2.5 TDI	AXG AHY	2,5	05.1998-04.2003	Chassis 70-1-048 286→	<b>7187D</b> <b>710614▲</b>	V A
T4	2.5 TDI	AJT ACV	2,5	05.1998-04.2003	Chassis → 70-1-048-285	<b>710574D▲</b>	V
T5	1.9 TDI	AXB AXC	1,9	04.2003-		<b>7372D</b> <b>710558</b>	V A
T5	2.5 TDI	AXE / AXD BLJ	2,5	04.2003-		<b>7649D</b> <b>710608▲</b>	V A
T5	2.5TDI	BNZ BPC	2,5	04.2003-11.2009		<b>710575D▲</b>	V

## Cross References

Manufacturer	Manufacturer No.	Article	Type
<b>ALFA ROMEO</b>	5520 9609	710559D	V
	7174 9240	710559D	V
	7175 2862	710559D	V
	7175 4796	710559D	V
	7175 4815	710559D	V
<b>AUDI</b>	038 131 501 AA	7372D	V
	038 131 501 AF	7496D	V
	038 131 501 AN	7496D	V
	038 131 501 AT	7371D	V
	038 131 501 E	7293D	V
	038 131 501 G	7241D	V
	038 131 501 T	7371D	V
	038 131 501 D	7241D	V
	045 131 501 C	7293D	V
	045 131 501 D	7301D	V
	045 131 501 F	7271D	V
	045 131 501 K	7271D	V
	045 131 501 L	7293D	V
	038 131 521 BM	61306D	L
	03G 131 521 AF	61306D	L
	03G 131 521 F	61306D	L
	038 131 521 CC	61384D	L
	038 131 521 AS	60700D	L
	028 131 521 AD	60364D	L
	038 131 521 BB	60702D	L
	059 131 525 P	60415D	L
	059 131 525 G	60347D	L
	059 131 525 Q	60347D	L
	038 131 521 L	60409D	L
	038 131 521 AJ	60633D	L
	03L 131 521	665104D	L
	03L 131 521 AB	665104D	L
	03L 131 521 AK	665104D	L
	03G 131 502	710572D	V
	03G 131 502 B	710572D	V
045 131 501	7301D	V	
<b>BMW</b>	11 71 7 810 871	710327D	V
	11 71 2 354 039	60579D	L
	11 71 7 563 241	7574D	V
<b>CITROËN</b>	1636 38	7523D	D
	1636 71	7523D	D
	1626 42	7631D	V
<b>FIAT</b>	50 032 2055	7350D	V
	50 409 9669	7497D	D
	50 410 5594	7523D	D
	50 412 1701	7631D	V
	50 434 5917	7523D	D
	50 434 5920	7497D	D
	50 426 4089	7523D	D
	7179 4613	710559D	V
	7179 4616	710559D	V
<b>FORD</b>	1100 628	7241D	V
	1461 874	7241D	V
	1212 966	7372D	V
	6M21 9D475 AA	7372D	V
	XM21 9D475 AA	7241D	V
	1 100 628	7241D	V

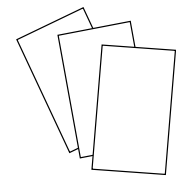

Manufacturer	Manufacturer No.	Article	Type
	1 119 320	7372D	V
	1 212 966	7372D	V
	1 461 304	7372D	V
	1 461 874	7241D	V
	1M21 9D475 AA	7372D	V
	YM21 9D475 AA	7372D	V
<b>IVECO</b>	50 032 2055	7350D	V
	50 409 9669	7497D	D
	50 410 5594	7523D	D
	50 434 5917	7523D	D
	50 412 1701	7631D	V
	50 434 5920	7497D	D
	50 426 4089	7523D	D
<b>MERCEDES-BENZ</b>	002 140 26 60	7159D	V
	601 140 00 57	60375D	L
	601 140 01 57	60375D	L
	601 142 09 64	60375D	L
	611 090 02 54	7220D	V
	611 090 03 54	7206D	V
	611 090 09 54	7206D	V
	611 140 00 57	60595D	L
	611 140 01 57	60595D	L
	612 098 04 17	7256D	V
	628 140 00 60	7396D	V
	628 140 01 60	7396D	V
	628 142 01 19	7396D	V
	640 140 07 60	7504D	V
	640 140 14 60	7504D	V
	640 140 18 60	7504D	V
	642 140 17 60	710476	V
	646 140 07 60	7389D	V
	646 140 08 60	7353D	V
	646 140 09 60	710023D	V
	646 140 17 60	7625D	V
	646 140 19 60	710023D	V
	646 140 23 60	7625D	V
	646 140 24 60	710023D	V
	646 140 27 60	710023D	V
	668 090 01 54	7234D	V
	668 090 04 54	7234D	V
	640 090 14 70	7545D	D
	640 090 20 70	7545D	D
	642 140 01 60	7527D	V
	640 140 19 60	710073D	V
	642 140 10 60	710095D	V
	642 140 14 60	710471D	V
	646 140 04 60	7389D	V
	642 140 03 60	7527D	V
	642 140 08 60	7527D	V
	642 140 04 60	7645D	V
	642 140 18 60	7645D	V
	629 140 06 60	7556D	V
	629 140 08 60	7556D	V
	629 140 15 60	7556D	V
	629 140 05 60	7557D	V
	629 140 07 60	7557D	V
	629 140 12 60	7557D	V

## Cross References

Manufacturer	Manufacturer No.	Article	Type
<b>MERCEDES-BENZ</b>	647 142 00 19	7610D	V
	647 142 02 19	7610D	V
	646 142 00 19	7610D	V
	646 142 01 19	7610D	V
	642 140 17 60	710476D	V
<b>MULTICAR</b>	4001620016	7523D	D
	4008160095	7631D	V
	820110583	7283D	V
<b>OPEL / Vauxhall</b>	58 51 041	7375D	V
	58 51 594	7375D	V
	9 196 675	7375D	V
	93 176 989	7375D	V
	91 28 572 A	7188D	V
	91 96 675	7375D	V
	für Saugmodul / for admission manifold 849 067	7188D	V
	für Saugmodul / for admission manifold 849 087	7188D	V
	für Saugmodul / for admission manifold 849 104	7188D	V
	für Saugmodul / for admission manifold 849 105	7188D	V
	für Saugmodul / for admission manifold 849 124	7211D	V
	für Saugmodul / for admission manifold 849 156	7211D	V
	für Saugmodul / for admission manifold 90 500 935	7188D	V
	für Saugmodul / for admission manifold 90 530 760	7188D	V
	für Saugmodul / for admission manifold 911 7505	7188D	V
	für Saugmodul / for admission manifold 912 8573	7188D	V
	für Saugmodul / for admission manifold 919 2805	7211D	V
für Saugmodul / for admission manifold 93 170138	7211D	V	
<b>PEUGEOT</b>	1626 42	7631D	V
	1636 38	7523D	D
	1636 71	7523D	D
<b>SAAB</b>	47 74 311	7375D	V
	53 38 033	7188D	V
	93 176 989	7375D	V
	91 96 675	7375D	V
	93 17 6989	7375D	V
<b>SEAT</b>	038 131 501 AA	7372D	V
	038 131 501 AN	7496D	V
	038 131 501 AB	7327D	V
	038 131 501 AF	7496D	V
	038 131 501 AQ	7241D	V
	038 131 501 AR	7283D	V
	038 131 501 E	7293D	V
	038 131 501 G	7241D	V
	038 131 501 M	7283D	V
	038 131 501 T	7371D	V
	03G 131 501 A	7451D	V
	03G 131 501 M	7451D	V
	045 131 501 C	7293D	V
	045 131 501 F	7271D	V
	045 131 501 K	7271D	V
	045 131 501 L	7293D	V
	03G 131 501 E	7529D	V
	038 131 521 BM	61306D	L
	03G 131 521 AF	61306D	L
	03G 131 521 F	61306D	L
	038 131 521 CC	61384D	L
	038 131 521 BL	60777D	L
	038 131 501	710570D	V



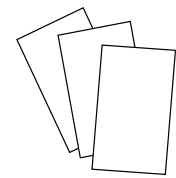

Manufacturer	Manufacturer No.	Article	Type
	038 131 501 BB	710570D	V
	038 131 501 D	7241D	V
	03G 131 502	710572D	V
	03G 131 502 B	710572D	V
<b>SKODA</b>	038 131 501 AA	7372D	V
	038 131 501 AB	7327D	V
	038 131 501 AF	7496D	V
	038 131 501 AL	7372D	V
	038 131 501 AM	7327D	V
	038 131 501 AN	7496D	V
	038 131 501 AR	7283D	V
	038 131 501 AT	7371D	V
	038 131 501 G	7241D	V
	038 131 501 M	7283D	V
	038 131 501 T	7371D	V
	03G 131 501 A	7451D	V
	03G 131 501 M	7451D	V
	045 131 501 C	7293D	V
	045 131 501 F / K / L	7271D	V
	038 131 521 BB	60702D	L
	028 131 521 AD	60364D	L
	059 131 525 P	60415D	L
	059 131 525 G	60347D	L
	038 131 501 BB	710570D	V
	038 131 501 D	7241D	V
	03G 131 502	710572D	V
	03G 131 502 B	710572D	V
	059 131 525 Q	60347D	L
<b>VOLKSWAGEN</b>	Aktuator für 038 131 063 D	710336	A
	Aktuator für 038 131 512 H	710336	A
	Aktuator für 03G 131 063 B	710336	A
	Aktuator für 03G 131 063 E	710336	A
	Aktuator für 03G 131 063	710413	A
	Aktuator für 03G 131 063 B	710413	A
	Aktuator für 03G 131 063 E	710413	A
	Aktuator für 03G 131 063 F	710413	A
	Aktuator für 03G 131 512 L	710413	A
	038 131 501	710570D	V
	038 131 501 AD	710571D	V
	038 131 501 AG	710570D	V
	038 131 501 BB	710570D	V
	038 131 501 BF	710571D	V
	038 131 501 BH	710571D	V
	038 131 501 C	710570D	V
	038 131 501 D	7241D	V
	038 131 501 AA	7372D	V
	038 131 501 AB	7327D	V
	038 131 501 AF	7496D	V
	038 131 501 AL	7372D	V
	038 131 501 AM	7327D	V
	038 131 501 AN	7496D	V
	038 129 637 D	7496D	V
	038 131 501 AQ	7241D	V
	038 131 501 AR	7283D	V
	038 131 501 E	7293D	V
	038 131 501 G	7241D	V
	038 131 501 J	7372D	V

## Cross References

Manufacturer	Manufacturer No.	Article	Type
<b>VOLKSWAGEN</b>	038 131 501 M	7283D	V
	038 131 501 N	7294D	V
	038 131 501 S	7496D	V
	038 131 501 T	7371D	V
	038 131 521 BL	60777D	L
	038 131 521 L	60409D	L
	038 131 521 AJ	60633D	L
	038 131 521 CC	61384D	L
	03G 131 501 A	7451D	V
	03G 131 501 M	7451D	V
	03G 131 521 AF	61306D	L
	038 131 521 BM	61306D	L
	03G 131 521 F	61306D	L
	03L 131 521	665104D	L
	03L 131 521 AB	665104D	L
	03L 131 521 AK	665104D	L
	045 131 501 C	7293D	V
	045 131 501 D	7301D	V
	045 131 501 F	7271D	V
	045 131 501 K	7271D	V
	045 131 501 L	7293D	V
	070 128 070 E	7649D	V
	070 128 070 F	7650D	V
	074 129 463 A	7223D	V
	07Z 131 501 A	7268D	V
	03G 131 501 E	7529D	V
	038 131 521 CC	61384D	L
	038 131 521 AS	60700D	L
	028 131 521 AD	60364D	L
	038 131 521 BB	60702D	L
	074 129 463 B	7187D	V
	038 131 521 CA	61010D	L
	03G 131 502	710572D	V
	03G 131 502 B	710572D	V
	045 131 501	7301D	V
	070 128 070 B	7649D	V
	070 128 070 C	7650D	V
	074 129 499 B	710574D	V
	076 131 501 A	710575D	V
	076 131 501 B	710575D	V

# Explanations

2 / 3 connections
2 / 4 pole
2-piece aluminum housing
A = actuator
EGR valve
automatic transmission
Chassis number
D = throttle flap
thermostat housing cover
seal
seal
DPF = Diesel particle filter
throttle flap
attached to the cylinder head
insert Thermostat
electrical
electrical heated
electrically controlled
no longer available
Europe
Excl. = exclude
for original number
housing
threat
Japan
catalyst
catalyst type
electrically heated thermostat
air conditioner
plastic cover
L = EGR-pipe
pipe throttle valve to cylinder head
metal cover
with
engine number
upper
without
oil cooling
organisation number
diesel sootfilter
pneumatic
Retarder
particle filter
manual transmission
black
series / Standard equipment
available while stocks last
thermal
lower
USA
V = EGR valve
variant
water cooling
additionally required parts
XXX → = from
→ XXX = up to
XXX → XXX = from → up to
▲ = new part number
● = article to be discontinued

## Thermostates and Thermoswitches



Catalog Commercial Vehicles



## Key to article numbers

# 4116.87D1

Type no.

Opening temperature

Gasket type

## Design-Principle 3 Plate Thermostat

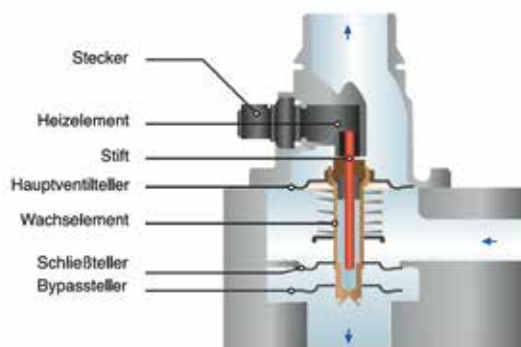

## Working Principle Cooling Water Thermostat

**Warm up period:** The engine enters the warm-up as soon as it is started. The thermostat is closed and the water circulates through the inner engine circuit.



**Normal operation:** The water temperature reaches the opening temperature of the thermostat. A small portion of the volumetric flow is fed through the radiator.



**Full temperature operation:** The bypass is sealed. The full volumetric flow is fed through the radiator.



**Reheating phase:** Maximum thermostat displacement occurs under special operating conditions such as reheating.



# Contents

<i>Engine</i>	1 - 13
<i>Cross references</i>	14 - 52
<i>Listing of gaskets</i>	54 - 57
<i>Supersession list</i>	58
<i>Main assembly dimensions</i>	60 - 71

<b>Hersteller</b>	<b>Thermostat</b>
CASE / I.H.C.	2
DAF	2
DEUTZ / MWM	2
EVOBUS / SETRA	2
FENDT	2
FIAT	3
FORD	4
HOLDER	4
IVECO	4
LOMBARDINI	5
MAN	6
MERCEDES BENZ	7
MULTICAR	8
PEGASO	8
PEUGEOT	9
RENAULT	9
SAURER	10
SCANIA	10
STEYR	11
VOLKSWAGEN	11
VOLVO	12
ZETOR	13

## About us

**BorgWarner Thermal Systems** is a leading supplier of components and systems for thermal management.

**BorgWarner Morse TEC** is the global leader of automotive chain systems and components for engine timing, automatic transmission and four-wheel drive applications.

**BorgWarner TorqTransfer Systems** is a leading manufacturer of torque distribution and management systems for four-wheel drive vehicles.

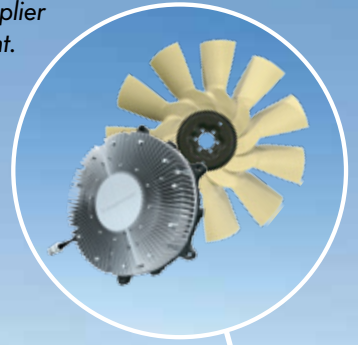



**BorgWarner Turbo Systems** is a leading manufacturer of turbochargers for passenger cars and commercial vehicle markets.

**BorgWarner Emissions Systems** is a leading manufacturer in the design and supply of exhaust gas recirculation (EGR) systems, ignition technology, diesel cold-start technology, cabin heaters and thermostats.

**BorgWarner Transmission Systems** supplies "shift quality" components and systems to virtually every automatic transmission manufacturer.

*Innovations for the aftermarket.  
From the product leader in the field of  
drive technology.*

*Many auto manufacturers all over the world agree on one thing: If they want their engines to meet the toughest emissions standards and break new ground in terms of fuel economy, if they want to combine excellent performance with a high level of reliability, then BorgWarner is the only choice. As product leader in the field of drive technology, we support the automotive industry in developing the vehicle generation of tomorrow. BorgWarner is also the perfect choice in the aftermarket. And not just because of the already legendary quality of our products. But also because of the selection, the range of services and the speed we offer our partners in the spare parts business.*

*Our solutions:  
precise, reliable, economical.*

*BorgWarner's Emissions Systems business unit is a leading global manufacturer and supplier of the latest exhaust gas emissions control systems, ignition technology, diesel cold-start technology, PTC interior heaters and thermostats for passenger vehicles and commercial vehicles all over the world. And with the product range of Wahler, which was acquired by BorgWarner in April 2014 and has been integrated into the Emissions Systems business unit, the product portfolio has been further expanded with a multitude of innovative solutions for the exhaust gas and temperature management of modern engines. Wahler will retain its product brand in the aftermarket segment.*



„Meine Wahl? Das Original.“  
“My Choice? The Original.”



### Thermostates and Thermoswitches

*BorgWarner Emissions Systems is a provider of Wahler brand thermostats and thermoswitches in OE quality. Our parts stand for proper functionality and outstanding reliability. Thanks to the optimum levels of heat management, they also ensure that engines live on, and on... Diversity made to measure – BorgWarner has the right parts for all current makes and models!*

Top OEM-  
quality

■ **Variety made to measure**

*BorgWarner Emissions Systems offers suitable Wahler spare parts for 62 automobile brands!*

■ **BorgWarner worldwide**

*BorgWarner is represented in all the world's important markets with its own subsidiaries and a dense service network. For more information, visit [aftermarket.borgwarner.com](http://aftermarket.borgwarner.com)*

■ **Service products included**

*BorgWarner Emissions Systems knows its customers' needs and always supplies original Wahler thermostats together with the matching gasket!*

## CASE / I.H.C.

	Restriction*	Thermostat	Kit	Gasket
D-155, D-179, D-206, D-239, D-310, D-358	ohne Gehäuse	4017.82		
353, 383, 423, 453, 523, 624, 724, 824, 654		4017.82		
433, 533, 553, 633, 733, 644, 743, 744, 745		4017.82		
844, 844S, 946, 955, 1046, 1055, 1246		4017.82		
743XL, 745XL, 844XL, 856XL, 956XL, 1056XL		4017.82		
1255XL, 1455XL		4017.82		
Typ 74, 84, 85 Europa 526 - 1056	ohne Gehäuse	4017.82		
Typ 968, 975, 9078, 9086, 9094		4512.85/1		

## DAF

MX 265				120875
MX 300 / 340 / 375				120875
PE 183 C / 228 C / 265 C				120875
PF 183 M / PF 212 M / PF 235 M				120875
PR 183 S / 228 S / 265 S				120875
RS 180 / L / M		4619.80	411133.80D	120875
RS 180 / L / M		4619.82		120875
RS 200 / L / M		4619.80	411133.80D	120875
RS 200 / L / M		4619.82		120875
RS 222 / L / M		4619.80	411133.80D	120875
RS 222 / L / M		4619.82		120875
VF 373 M				120875
WS 225		4619.80	411133.80D	120875
WS 242 / L / M		4619.75		120875
WS 242 / L / M		4619.80	411133.80D	120875
WS 259		4619.80	411133.80D	120875
WS 268 / G / L / M		4619.80	411133.80D	120875
WS 282		4619.80	411133.80D	120875
WS 295 / G L / M		4619.80	411133.80D	120875
WS 315 7 G / L / M		4619.80	411133.80D	120875
XE 250 C / 280 C / 315 C / 355 C / 390 C				120875
XF 250 M / 280 M / 315 M / 355 M				120875

## DEUTZ / MWM

D 208, D 225		2391.75		
D 226, TD 226, D 227, TD 228, D 325, D 327		2393.75		
F 2 / 3 / 4 M 1008		4007.80D		
B 2 / 3 / 4 M 1008		4007.80D		
226 / B3 TD		4512.85/1		
226		4512.75/1 ▲		

## EVOBUS / SETRA

Serie 200 S 215	2 x	4105.83D		
Serie 400 S 411 / 415 / 416 / 417 / 431	2 x	4105.83D		

## FENDT

FW 135, 138, 180, 181, 182, 184		2391.75		
FW 238, 258, 268, 278		2391.75		
F 281, 282, 283, 284, 285		2389.75/1		
Farmer 304, 305, 306, 307, 308, 309	3 Anschlüsse	2391.75		
Farmer 305 LS, 307 LS	4 Anschlüsse	2393.75		

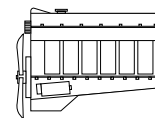

**FIAT**

	Restriction*	Thermostat	Kit	Gasket
149 B1.000 / 149 B3.000		3431.80D		
169 B / 170 B / 170 D		3061.82		
182 B6.000		3163.88D		
182 B9.000 / 186 A9.000		410589.88D		
199 A2.000 / 199 A9.000		410048.88D		
223 A5.000 / 223 B1.000 / 223 B2.000		3105.87D		
223 A7.000		410589.88D		
223 A9.000		410048.88D		
280 A1.000		3431.80D		
350 A1.000		410090.88D		
4HV		3497.88D		
8140.21 / 23 / 27 / 43 / 47 / 63 / 67		4174.79D		
8140.21 / 23 / 27 / 43 / 47 / 63 / 67		4174.82D		
8144.61		4008.79D		
843 A1.000		410090.88D		
CRD93L (U25-661)		4174.82D		
D8B / D9B		4446.83D		
DHX		4446.83D		
DHX		4450.83D		
DJY		4446.83D		
DW 8 / DW 10		4446.83D		
DW10ATED4 (RHW)		4446.83D		
EW 10J4		3483.89D		
F1A E0481 C		3171.82D		
F1A E0481 N		410937.82D ▲		
F1A E3481 D		410937.82D ▲		
F1C E0481 D		410075.79D ▲		
F1C E3481 E		410075.79D ▲		
F1C E3481 M		410075.79D ▲		
F1C E3481 N		410075.79D ▲		
RFL / RFW		3136.82D50		
RFN		3483.89D		
RHV / RHW / RHX / RHZ		4446.83D		
WJZ		4446.83D		
XM7T		3061.82		
XN 1T		3061.82		
XUD9A		4446.83D		
XUD9TF		4446.83D		
XUD9TF		4450.83D		
<b>Fiat Traktor</b>				
Traktor Typ 45.66, 50.66		4008.79D		
Traktor Typ 55.46 / 56 / 66 / 88 / 90		4008.79D		
Traktor Typ 60.46 / 56 / 66 / 90 / 93 / 94		4008.79D		
Traktor Typ 65.46 / 56 / 66 / 90, 70.90		4008.79D		
Traktor Typ 80.66 / 90, 85.90, 95.90		4008.79D		
Traktor Typ 95.90		4008.79D		
Traktor Typ 100.90, 110.90, 115.90		4008.79D		
Traktor Typ 250, 420, 440, 450, 470, 474		4008.74D		
Traktor Typ 500, 540, 550, 566, 570, 580		4008.79D		
Traktor Typ 600, 640		4008.74D		
Traktor Typ 666, 670, 680		4008.79D		
Traktor Typ 766, 780		4008.79D		
Traktor Typ 980, 1000, 1180, 1280, 1300 s, 1380		4008.74D		
Traktor Serie 900 Typ 980		2391.75		
Traktor Typ 1280, 1380, 1580, 1880		4008.79D		
Traktor Typ 3435, 3935, 4135, 4635, 4835, 5635, 6635, 7635		4008.74D		

# Engine

## FORD

	Restriction*	Thermostat	Kit	Gasket
4AB / 4BA / 4CA		4147.80D		
4BC / 4CC / 4DA / 4EA / 4EB / 4EC / 4ED		4270.88D		
4FA / 4FB / 4FC / 4FD		4270.88D		
4GA / 4GB / 4GC / 4GD / 4GE / 4GF		410131.88D		
4HA / 4HB / 4HC / 4HD		4270.88D		
4RB / 4RC		3021.88D50		
ABFA		3497.88D		
B		3021.88D50		
BHPA		410131.88D		
BRT		4270.80D		
CVRA / CVRB / CVRC		3497.88D		
CYFB / CYFA / CYFC / CYFD / CYRA / CYRB / CYRC		3497.88D		
D2FA / D2FB / D2FE / D3FA / D4FA / DOFA		3497.88D		
DRFA / DRFD / DRFE / DRFB / DRFC		3497.88D		
DRRC / DRRR / DRRB		3497.88D		
E5FA / E5FC / E5FA		3100.88D		
EX / EY		3021.88D50		
EYPC / EYPA / EYPD		4270.88D		
F3FA / F4FA / F1FA / FXFA		3497.88D		
FUJA / FUJB		4457.82D		
FXJB / FXJA / FYJA / FYJB	→ 09.2003	4457.82D		
FXJB / FXJA / FYJA / FYJB	09.2003 →	4483.82D		
H9FA / H9FB / H9FD		3497.88D		
HCPB / HCPA		410131.88D		
JXFC / JXFA		3497.88D		
L3C / LAT / LCR / N6T / N6TS / NAE		3021.88D50		
NAT / NAV / NAW / NAX / NBA / NCA		3021.88D50		
NSF / NSG / NSH		3100.88D		
P7PA / P7PB		410131.88D		
P8FA / P8FB		3497.88D		
P9PA / P9PB / P9PC / P9PD		410131.88D		
PGFA / PGFB / PHFA / PHFC		3497.88D		
QVFA / QWFA		3497.88D		
R2PA / R3PA / RWPA / RWPC / RWPE / RWPF / RWPD		410131.88D		
RFA		4270.88D		
RWPA		410131.88D		
SAFA / SAFB / SRFA / SRFC / SRFB / SRFE / SRFD		3497.88D		
UHFA / UHFB / UHFC / USRA / USRB		3497.88D		

## HOLDER

Typ A40, 50, 60 / Turbo		3000.83		
Typ AG 3, AG 35,		3000.83		
Typ AM 2, B 25, P 50		3000.83		

## IVECO

8040.05 / 25 / 45		4166.79D		
8060.04/ 05 / 24 / 25 / 45		4165.79D		
8140.07 / 23 / 27 / 43 / 47 / 63 / 67 / 97		4174.79D		
8140.21 / 61		4151.79D		
8140.43	Serienausführung	4174.82D		
8140.43		4174.88D ▲		
8140.61.200		4151.79D		
8210.22 / 42	2 x / Motornummer 264992 →	4165.79D		
8210.42	2 x	4163.79D		

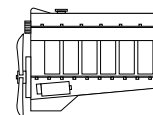
**IVECO**

	Restriction*	Thermostat	Kit	Gasket
8280.22		4152.79D		
8280.42.001	Motornummer 108436 →	4163.74D		
8280.42.001	Motornummer 108436 →	4163.79D		
8280.42.050		4163.74D		
8280.42.050		4163.79D		
8280.42S. TCA	2 x / Motornummer →116714	4163.79D		
8280.42S. TCA	1 x / Motornummer 116715 → 227934	4163.74D		
8280.42S. TCA	1 x / Motornummer 116715 → 227934	4163.79D		
8280.42S. TCA	2 x / Motornummer 227935 →	4163.79D		
8280.42S.342 / 352		4163.74D		
8280.42S.342 / 352		4163.79D		
8280.42S.350	2 x / Motornummer →116714	4163.79D		
8280.42S.350	1 x / Motornummer 116715 → 227934	4163.74D		
8280.42S.350	1 x / Motornummer 116715 → 227934	4163.79D		
8280.42S.350	2 x / Motornummer 227935 →	4163.79D		
8360.46		4165.79D		
8460.21 / 41	2 x	4162.79D		
8460.41	2 x	4165.79D		
F1AE0481 A / B		3171.82D		
F1AE0481 D / FA / GA / HA		410937.82D ▲		
F1AE0481 M		3171.82D		
F1CE0481 A / B		3169.79D		
F1CE0481 FA / HA / HC		410081.79D		
F2BE0681 A / B / C / D / E / F	Wasserkühlung	4619.86	410608.86D	120213
F2BE0681 A / B / C / D / E / F	Ölkühlung	4622.82D0		
F2BE0681 A / B / C / D / E / F	Ölkühlung Motornummer 13702 →		410763.82D	
F2BE1682 G	Ölkühlung	4622.82D0		
F2BE1682 G	Ölkühlung Motornummer 13702 →		410763.82D	
F2BE3681 A / B	Wasserkühlung	4619.86	410608.86D	120213
F2BE3681 A / B	Ölkühlung	4622.82D0	410763.82D	
F2BE3681 C	Wasserkühlung	4619.86	410608.86D	120213
F2BE3681 C	Ölkühlung	4622.82D0		
F2BE3681 C	Ölkühlung Motornummer 13702 →		410763.82D	
F3AE0681 B / D / E	Ölkühlung	4622.82D0		
F3AE0681 B / D / E	Ölkühlung Motornummer 14695 →		410763.82D	
F3AE3681 A / B	Ölkühlung	4622.82D0	410763.82D	
F3B3681 A	Ölkühlung	4622.82D0		
F3B3681 A	Ölkühlung Motornummer 14695 →		410763.82D	
F3B3681 B / C / D	Ölkühlung	4622.82D0	410763.82D	

**LOMBARDINI**

LDW 502		4007.80D		
LDW 602		4007.80D		
LDW 702		4007.80D		
LDW 903		4007.80D		
LDW 1003		4007.80D		
LDW 1204		4007.80D		
LDW 1204/T		4007.80D		
LDW 1404		4007.80D		
LDW 1503		4007.80D		
LDW 2004		4007.80D		
LDW 2004/T		4007.80D		

# Engine

MAN	Restriction*	Thermostat	Kit	Gasket
D 0224 ME / MF		4150.79D50		
D 0226		4150.79D50		
D 0824 FL / LF / LFL / LFO / LOH		4150.83D50		
D 0824 GF		4150.79D50		
D 0824 LF	Automatikgetriebe	410864.79D0		
D 0824 LOH	Automatikgetriebe	410864.83D0		
D 0826 F / LF / LFL / TF	Automatikgetriebe	410864.79D0		
D 0826 F / LF / LOH / OH / TF / TOH		4150.79D50		
D 0826 GF / LF / LFL / LUH / TOH		4150.83D50		
D 0826 LOH / LUH	Automatikgetriebe	410864.83D0		
D 0834 LFL		4150.83D50		
D 0836 HM 3 U		4373.70 •		
D 0836 LF		4150.79D50		
D 0836 LF		4150.83D50		
D 0836 LOH / LUH	2 x	4150.83D50		
D 0846 HM 91 U / 95 U		4351.79		
D 2066 LF	2 x	4150.79D50		
D 2066 LF	2 x	4150.83D50		
D 2530 MF / MTE / MTXF / MXF	2 x	4150.79D50		
D 2538 M / MF / MT	2 x	4150.79D50		
D 2540 MTF	2 x	4150.79D50		
D 2555 M / MF / MX / MXF / MXUL	2 x	4150.79D50		
D 2556 M / MF / MX / MXF / MXUH / MXUM	2 x	4150.79D50		
D 2565 HM / ME / MK / MS / MT / MUH	2 x	4150.83D50		
D 2565 M / MF / MUL	2 x	4150.79D50		
D 2566 M / MF / MH / MH / MK / ML / MT / MU / UH	2 x	4150.79D50		
D 2566 MLU / MSF / MT / MXF	2 x	4150.83D50		
D 2566 MUH / UH	Automatikgetriebe	410864.83D0		
D 2658 M2	2 x	4150.83D50		
D 2676 LF / LOH	2 x	4150.83D50		
D 2840 LF / MF / MFG	2 x	4150.79D50		
D 2840 LYE / ME / MH	2 x	4150.83D50		
D 2842 LE / LXE / LYE / LZE / ME	2 x	4150.83D50		
D 2848 LXE / LYE / M / MH	2 x	4150.83D50		
D 2858 M	2 x	4150.83D50		
D 2865 LF / LOH / LU / LUH / LXF	2 x	4150.79D50		
D 2865 LF / LOH / LUH / LXF	2 x	4150.83D50		
D 2865 LF / LUH	Automatikgetriebe	410864.83D0		
D 2866 F / KF / KO / KU / LF / LO / LU / LX / T / U	2 x	4150.79D50		
D 2866 F / KF / KO / KU / LF / LO / LU / LX / T / U	2 x	4150.83D50		
D 2866 LU	2 x	4150.71D50		
D 2866 LUH / TOH / TUH / UH	Automatikgetriebe	410864.83D0		
D 2868 LF	2 x	4150.79D50		
D 2868 LF	2 x	4150.83D50		
D 2876 LF	2 x	4150.79D50		
D 2876 LF	2 x	4150.83D50		
D 2876 LOH	2 x	4150.71D50		
D 2876 LOH	2 x	4150.79D50		
D 2876 LOH	2 x	4150.83D50		
E 2866 DF / DOH	2 x	4150.83D50		
E 2866 DF / DUH	2 x	4150.79D50		
G 2866 DOH / DUH	2 x	4150.83D50		

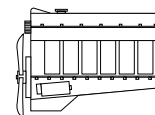

## MERCEDES BENZ

	Restriction*	Thermostat	Kit	Gasket
M 102.942/943/945/946		4078.87D		
M 104.900		4123.80D		
M 111.948/950/978/980		4279.87D		
M 111.979/984		4275.87D		
M 112.951/976		4281.87D		
M 115.921/927/928/929/952/970/971		4105.83D		
M 115.955/972		4078.87D		
M 271.951		3457.90D		
M 272.978/979		4833.100D ▲		
OM 314.910/915→917/944/946/948/953/956/957/ 959/961→968		4083.83D50		
OM 314.970		4105.83D		
OM 327.910/914→919/931→946		4083.83D50		
OM 352 / OM 353		4083.83D50		
OM 352.901/904/908/915/917/930/931/936/938	Motornummer →004710	4351.79		
OM 352.901/904/908/915/917/930/931/936/938	Motornummer 004711→	4083.83D50		
OM 352.944/945/948/953/954/955/963/969/991	Motornummer →004710	4351.79		
OM 352.944/945/948/953/954/955/963/969/991	Motornummer 004711→	4083.83D50		
OM 354		4105.83D		
OM 355		4105.83D		
OM 356		4105.83D		
OM 357		4105.83D		
OM 360.911/914→918/931/933/936→949/979→ 981/984→986		4083.83D50		
OM 362		4105.83D		
OM 364		4105.83D		
OM 366		4105.83D		
OM 382.916/917/950		4105.83D		
OM 401 / 402 / 403	2 x	4105.83D		
OM 407	2 x	4105.83D		
OM 421 / 422 / 423	2 x	4105.83D		
OM 427 / 429	2 x	4105.83D		
OM 440 / 441 / 442 / 443	2 x	4105.83D		
OM 445 / 446	2 x	4105.83D		
OM 447 / 457	2 x	4105.83D		
OM 458.960/970/980	2 x	4105.83D		
OM 481.902/904	2 x	4105.83D		
OM 482.902/904	2 x	4105.83D		
OM 521.940/950	2 x	4105.83D		
OM 522.940→943	2 x	4105.83D		
OM 541.920→928/940→952/970/972/974/976	2 x	4105.83D		
OM 542.920→926/940→ 945/947/948/956/957/960/962/964	2 x	4105.83D		
OM 601.940/941/943	ohne Gehäuse	4176.85D		
OM 601.940/941/943	mit Gehäuse	4280.85D		
OM 601.942/970		4176.80D		
OM 602.940/941/948		4176.85D		
OM 602.980/982/984	ohne Gehäuse	4176.85D		
OM 602.980/982	mit Gehäuse	4280.85D		
OM 611.980/981/987	ohne Gewinde	410171.87D		
OM 611.980/981/987	mit Gewinde	411433.87D ▲		
OM 612.981	ohne Gewinde	410171.87D		
OM 612.981	mit Gewinde	411433.87D ▲		
OM 615.917/937/939		4049.80D1		
OM 616.910		4078.79D		
OM 616.913/914/937/939/963		4049.80D1		
OM 616.917/934		4049.80D		



# Engine

## MERCEDES BENZ

	Restriction*	Thermostat	Kit	Gasket
OM 617.913		4049.80D1		
OM 642.896/898/992/993		4490.87D ▲		
OM 642.896/898/992/993	elektrisch beheizt	410055.87D ▲		
OM 642.990		4832.87D ▲		
OM 646.980→985/990	ohne Gewinde	410171.87D		
OM 646.980→986/989/990	mit Gewinde	411433.87D ▲		
OM 900.911→913/917→919		4105.83D		
OM 902.910/913→915		4105.83D		
OM 902.911/912/922/927		4472.83D ▲		
OM 904.904→959/961/962/964→968		4105.83D		
OM 906.910→935/937/938/940/941/944→955		4105.83D		
OM 906.936/967		4472.83D ▲		
OM 906.957→960/962→966/968/970/971/974→983/985/988		4105.83D		
OM 907.910/920/930/940/941/960/970/980/990		4105.83D		
OM 909.900/901/910/911/920/921/960/970/971		4105.83D		
OM 924.910→912/914→916/919/920/922→924		4105.83D		
OM 924.917		4472.83D ▲		
OM 926.910→912/914/915/917/918/921		4105.83D		
OM 926.916/920		4472.83D ▲		
OM 926.924→929/932/934/937→939		4105.83D		
OM 941.910/920/921/929/930/940/960/970/980/981/990		4105.83D		
OM 942.910→912/925/930/960/967/970/980		4105.83D		

## MULTICAR

028.B M 344/M 841		4256.80D		
028.B M 344/M 841		4253.87D		
Engine Iveco 8140		4174.79D		
FUMO 2.8	82° Serienausführung	4174.82D		
FUMO 2.8	88°	4174.88D ▲		
FUMO 3.0		410081.79D		
FUMO 3.0	AGR-Ventil	7631D		
FUMO 3.0	Drosselklappe	7523D		
M 25 1.9	80°	4256.80D		
M 25 1.9	87° Serienausführung	4253.87D		
M 26 1.9	80°	4256.80D		
M 26 1.9	87° Serienausführung	4253.87D		
M 26 2.5 / 2.8		4174.79D		
M26 EcoLine, Profiline, Transline	79° Serienausführung	4174.79D		
M26 EcoLine, Profiline, Transline	82° Serienausführung	4174.82D		
M26 EcoLine, Profiline, Transline	88°	4174.88D ▲		
TREMO Carrier, Carrier S		4264.87D		
TREMO Carrier, Carrier S	AGR-Ventil	7283D		
TREMO 501	Motor AFD / AVM	4264.87D		
TREMO 601	Motor OM 601	4176.85D		
UX 100 OM 602	ohne Gehäuse	4176.85D		
UX 100 OM 602	mit Gehäuse	4280.85D		

## PEGASO

9105 / 9220		4078.75D		
9156		4619.75		
200CV / 200CV TURBO / 260CV		4078.75D		
300 CV → 400 CV (TRONER)		4619.75		

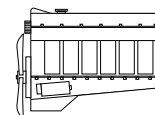
**PEUGEOT**

	Restriction*	Thermostat	Kit	Gasket
169B (XM7T) / 170 (XN1T) / 170B (XN1T) / 170D (XN1TACP)		3061.82		
169B (XM7T) / 170 (XN1T) / 170B (XN1T) / 170D (XN1TACP)		3061.88		
4HU 4HU (P22DTE) / 4HV (P22DTE)		3497.88D		
8140.43		4174.82D		
8140.43		4174.88D ▲		
CRD93 (U25/661) / CRD93LS (U25/673)		3033.84D		
DJ5 / DJ5 T / DJ5 TED		410058.84D		
DW10 ATED		4446.83D		
DW10 BTED		4446.83D		
DW10 TD		4446.83D		
DW10 UTD		4446.83D		
DW12 UTED		4446.83D		
EW10 A		3483.89D		
EW10 J4		3483.89D		
F1CE0481D (FG30DT)		410075.79D ▲		
XB5P / XC5P / XC7P / XD2P94 / XDP88 / XDP90 / XM7P / XN1P		3053.75		
XD3P		4147.80D		
XM7T		3061.82		
XM7T		3061.88		
XN1T		3061.82		
XN1T		3061.88		
XU10 J2		3136.82D50		
XU10 J2		3136.82D50		
XUD7 / XUD9 A		4446.83D		
XUD9 AU		4446.83D		
XUD9 TE		4450.83D		
XUD9 UT		4450.83D		
XUD9 UTF		4450.83D		

**RENAULT**

8140.07 / 21 / 23 / 27 / 43 / 47 / 63 / 67		4174.79D		
8140.21 / 23 / 27 // 43 / 47 / 61 / 67		4151.76D		
829 730 / 731		4122.87D		
841 705		3053.85		
847 700 / 701		3029.86		
852 720 / 750		4147.80D		
A1M 705 / A1M 707 / A1M 708		3053.85		
C1J700		3029.86		
dCi 11-270	→ 06.2003	410828.86D0	410828.86D	120875
dCi 11-270	06.2003 →	4619.86		120875
dCi 4B / 4C	06.2003 →	4619.86		120875
dCi 4B / 4C	→ 06.2003	410828.86D0	410828.86D	120875
dci 6A / 6W	06.2003 →	4619.86		120875
dci 6A / 6W	→ 06.2003	410828.86D0	410828.86D	120875
F1N 720 / 722 / 724		3470.89D50		
F4R 720 / 722 / 820		3466.89D		
F8Q 606	Einsatzthermostat	3470.89D50		
F8Q 606	mit Gehäuse	410530.89D ▲		
F9Q 760 / 762		410517.83D		
F9Q 770	ab Motor 000529	3470.89D50		
F9Q 772 / 774		410517.83D		
J5R 716 / 718 / 726 / 728		4122.87D		
J7T 600 / 780 / 782 / 788		4122.87D		
J8S 330 / 620 / 758		4147.80D		

# Engine

## RENAULT

	Restriction*	Thermostat	Kit	Gasket
M9R 630 / 692 / 780 / 782 / 786		411476.83D ▲		
MACK E.TECH A / B / C 46		411045.82D		120875
MDS 06.35.40		4596.83D		
MIDR 04.02.26		410828.86D0	410828.86D	120875
MIDR 04.02.26		410828.82D0	410828.82D	120875
MIDR 06.02.12		410828.86D0	410828.86D	120875
MIDR 06.02.12		410828.82D0	410828.82D	120875
MIDR 06.02.26		410828.82D0	410828.82D	120875
MIDR 06.02.26		410828.86D0	410828.86D	120875
MIDR 06.20.30 A		4596.83D		
MIDR 06.20.45		4596.83D		
MIDR 06.23.56		4596.83D		
MIDR 06.24.65 A / B / C		411045.82D		120875
MIDR 06.24.65 H / J / L / M / N / P	(2 x 4596.83 + gasket)	410758.83D		
MIDR 06.35.40 / C / G		4596.83D		
MIDS 06.02.12		410828.82D0	410828.82D	120875
MIDS 06.02.12		410828.86D0	410828.86D	120875
MIDS 06.20.30		4596.83D		
MIDS 06.20.45		4596.83D		
MIDS 06.35.40		4596.83D		
MIVR 08.35.30	2 x	4596.83D		
MIVS 08.35.30	2 x	4596.83D		
S8U 720 / 722 / 750 / 752 / 770 / 772		4174.79D		
S8U 731		4008.79D		
S8U 731		4174.79D		
S8U 742		4008.79D		
S8U 758 / 780		4151.76D		
S9W 700 / 702		4174.79D		
S9W 702		4174.79D		
Traktoren 50, 60, 70, 80		2393.75		
Traktoren 351, 421, 461, 462		2393.75		
Traktoren 551, 556, 651, 652, 656		2393.75		
Traktoren 751, 752, 781, 851, 891, 981		2393.75		
Traktoren 1181		2393.75		

## SAURER

CKT, C2 K, C2K-T		4530.80		
DA, DC, DCL, DAU, DCU, DCUL, DKU-D1 KUL		4030.70		

## SCANIA

D 8 / DN 8 / DS 8		4520.80D		
DN 9 / DS 9 / DSC 9.01 / 02 / 07-10		4520.80D		
DC 9 / DSC 9.11 / 12 / 13 / 15 Typ Serie 4		4224.80D		
D 11 / DN 11 / DS 11 / DSC 11 / DTC 11		4520.80D		
DC 11 / DSC 11	ohne Retarder	4223.83D		
DC 11 / DSC 11	mit Retarder	4224.80D		
OSC 11.03	ohne Retarder	4223.83D		
OSC 11.03	mit Retarder	4224.80D		
DC 12 / DSC 12 / DT 12	ohne Retarder	4223.83D		
DC 12 / DSC 12 / DT 12	mit Retarder	4224.80D		
DC 13	ohne Retarder	411004.80D		
DC 13	mit Retarder	4224.80D		
D 14 / DS 14 / DSC 14		4520.80D		
DSC 14.13 / 15 Typ Serie 4	ohne Retarder	4223.83D		
DSC 14.13 / 15 Typ Serie 4	mit Retarder	4224.80D		
DSI 14	ohne Retarder	4223.83D		

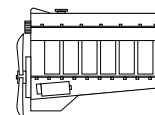

## SCANIA

	Restriction*	Thermostat	Kit	Gasket
DSI 14	mit Retarder	4224.80D		
DC 16	ohne Retarder	4223.83D		
DC 16	mit Retarder	4224.80D		
DT 16.08		4224.80D		
Bus Serie 3 K 93, K 113, L 113		4520.80D		
<b>Industrie:</b>				
DC 9A		4223.75D		
DC 9A		4223.83D		
DSI 11 EO1		4520.80D		
D 12 / D 12 M		4223.75D		
D 12 / D 12 M		4223.83D		
DI 12		4223.75D		
D 16 M		4223.75D		
<b>Dichtung / Gasket / Joint</b>				
<b>für / for / pour</b>				
4223.75D / 4223.83D		122689		
4224.75D / 4224.80D / 411004.80D		122690		

## STEYR

WD 311.40 / 41		4368.87		
WD 411.41 / 42 / 43 / 44 / 45 / 46 / 85 / 86 / 87 / 88 / 89		4368.87		
WD 611.40 / 41 / 42 / 43 / 85 / 86 / 87 / 88		4368.87		
WD 815.60 / 70		410864.79D0		
<b>Traktor</b>				
Typ 8060, 8070, 8075, 8080, 8090		4368.87		
Typ 8100, 8110, 8120, 8130		4368.87		
Typ CS 68, 78, 86		4512.85/1		
Typ CS 75 → DBD 002 3065		4512.85/1		
Typ CS 94 → DBD 001 0601		4512.85/1		

## VOLKSWAGEN

1 E / 1G / 1S		4123.80D		
1F / 1X / 1Y / 1Z		4264.87D		
2L		3477.88D		
2Y / 4Y		4103.82D		
AAB / AAF / ACU / ACV / AEN / AET / AEU		4116.87D1		
AAC / ABL / AEF / AEY		4264.87D		
ACL / ACT / AES		4123.80D		
AEE / AEX		3143.87D	410989.87D ▲	
AGK / ATA / AUH		3145.79D		
AGL		4275.87D		
AGX / AHD		4116.87D1		
AHB / AHU		4264.87D		
AHY / AJA / AJT		4116.87D1		
AKV		3143.87D		
ALE / ALH		4264.87D		
AMV		4123.80D		
AMV		4455.80D		
ANJ / APA / APL / AUF		4116.87D1		
APQ / AUA / AUD		3143.87D	410989.87D ▲	
ATA / AUH		3145.79D		
AVR / AVT		4116.87D1		

# Engine

## VOLKSWAGEN

	Restriction*	Thermostat	Kit	Gasket
AXA		3141.87D		
AXB / AXC / AYQ		4264.87D		
AXD / AXE		4430.87D		
AXG / AXL / AYC / AYY		4116.87D1		
BBE / BBF / BJK / BJJ / BJL / BJM		4116.87D1		
BCA / BUD		3143.87D	410475.87D ▲	
BCQ		3145.79D		
BDJ / BJB / BRR / BRS / BST		4264.87D		
BDL / BKK		4455.80D		
BGU / BSE / BSF / BSX		3141.87D		
BLJ / BNZ / BPC		4430.87D		
BLS / BMM / BSU		4820.87D		
CAYD / CAYE		410845.92D ▲		
CEBA / CEBB / CECA / CECB		4116.87D1		
CFHC / CFHE / CFHF / CFJA / CLCA / CLCB		410845.87D ▲		
CG / CH		4006.82D		
CHGA		3141.87D		
CS		4253.87D		
DF / DG / DH / DJ / GW / MV / SR / SS		4155.87D		
DL / DW / DV		4123.80D		
EM / EW / JB / JH		4264.87D		
JK / ME		4253.87D		
JX / KY		4256.80D		
PD		4253.87D		
SR / SS		4155.87D		

## VOLVO

D 6 A / D 12 A / C		4619.86		
D 16 A / B		4619.86		
TD 40 A / 41 G		4038.81D		
D 50 A / B		4038.76D		
TD 50 A / B		4038.76D		
D 60 A / B		4038.81D		
D 70 A / B		4038.81D		
TD 60 A / B / C		4038.81D		
TD 61 F / G / E		4619.82		
TD 61 F / G / E		4619.86		
TD 63 E		4619.86		
TD 70 A / B / C / D / E / F / G		4038.81D		
TD 70 G		4619.82		
TD 71 F		4619.82		
TD 73 E		4619.82		
D 100 A / B		4038.76D		
D 100 A / B		4038.81D		
HD 100 A / D		4038.76D		
HD 100 A / D		4038.81D		
TD 100 A / B		4038.76D		
TD 100 A / B / C / G		4038.81D		
THD 100 A / D / E		4038.81D		
TD 101 F / G		4619.82		
THD 101 G / K		4619.82		
TD 102 F / TD 103 E		4619.82		
TD 102 F / TD 103 E		4619.86		
TD 120 A		4038.76D		
TD 120 A / C / D / E / F / G		4038.81D		
TD 121 F / G		4619.82		
TD 122 E / F		4619.82		

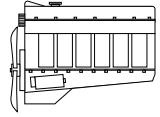

**VOLVO**

Restriction\*

Thermostat

Kit

Gasket

TD 123 E

4619.82

TD 162 F

4619.82

TD 162 F

4619.86

TD 163 ES

4619.82

TD 163 ES

4619.86

**ZETOR**

Typ 8011, 8045, 12011, 12045

4030.78

## Cross References

Manufacturer	Manufacturer's Ref.	Wahler-ref.	Manufacturer	Manufacturer's Ref.	Wahler-ref.
AGCO	X815.090.002.000	2391.75		077 121 113 C	4274.82D
				078 121 113 C	4274.87D
ALFA ROMEO	105.00.01.064.00	3000.83		078 121 113 F	4274.87D
	105.00.01.064.01	3000.83		078 121 113 G	4274.92D
	5177 0698	411193.82D		078 121 113 H	4274.92D
	5520 2510	410049.88D		078 121 113 J	4274.87D
	5521 5006	410871.80D ▲		191 959 481 A	6017.95D
	6050 4230	4003.86		191 959 481 B	6020.95D
	6051 6212	4160.83D		191 959 481 C	6017.95D
	6066 3619	410590.88D		1H0 959 481	6037.95D
	6071 0617	3067.83		1H0 959 481 B	6037.95D
	6071 3535	4008.79D		251 959 481	6017.95D
	6081 5681	410512.88D		251 959 481 G	6087.87D
	6081 6681	410511.88D		251 959 481 H	6087.87D
	7175 4778	410049.88D		251 959 481 K	6087.87D
	761 5234	4022.82D1		321 959 481 A	6017.95D
				321 959 481 C	6017.95D
ASTON MARTIN	52 06 139	3004.82		321 959 481 D	6017.95D
				321 959 481 E	6020.95D
AUDI	022 121 113	4455.80D		6U0 959 481 A	6017.95D
	025 121 113 D	4155.87D		811 959 481	6024.95D
	025 121 113 E	4155.87D		823 959 481	6010.92D
	025 121 113 F	4155.87D		823 959 481 A	6010.92D
	030 121 113 B	4264.84D		823 959 481 F	6010.92D
	032 121 110 B	3143.87D	823 959 481 G	6010.95D	
	032 121 110 F	3167.83D	823 959 481 L	6010.92D	
	032 121 110 L	410475.87D	867 959 481	6039.95D	
	032 121 110 P	3143.87D	893 959 481	6024.95D	
	032 121 121 G	410475.87D			
	032 121 121 K	410475.87D	AUTOBIANCHI	415 4313	3023.87D
	035 121 113	4088.80D		421 8649	3345.79
	035 121 113 B	4088.87D		426 3997	6010.95D
	036 121 113	3091.92D		4355 8460	4091.82D
	036 121 113 A	3091.92D		4409 2540	4091.82D
	036 121 113 B	3091.92D		7545 9580	3105.87D
	03G 121 111 A	4820.87D		7581 3190	3105.87D
	03G 121 113	3472.87D			
	03G 121 113 A	4820.87D	BMW	11 51 7 500 597	410793.95D
	03L 121 111 AE	410845.87D		11 53 0 139 877	4326.97D
	03L 121 111 R	410845.92D		11 53 1 247 125	410792.95D
	03L 121 111 S	410845.92D		11 53 1 251 041	4231.80D
	03L 121 113 B	410537.92D		11 53 1 253 248	3344.80
	03L 121 114 B	410536.92D		11 53 1 253 249	3344.80
	044 121 113	4264.87D		11 53 1 254 065	4231.80D
	050 121 113 C	3141.87D		11 53 1 260 720	3344.75
	052 121 113 A	3091.92D		11 53 1 264 668	4232.80D
	056 121 113 A	4256.80D		11 53 1 265 085	4232.80D
	056 121 113 D	4264.87D		11 53 1 265 086	4232.71
	059 121 113 A	4006.82D		11 53 1 312 288	4619.80
	059 121 113 B	4006.82D		11 53 1 315 063	4619.80
	068 121 113 H	4253.87D		11 53 1 318 274	4621.80D
	069 121 113	4116.87D1		11 53 1 432 881	410792.95D
	06D 121 111 G	411186.87D		11 53 1 436 042	411573.105D ▲
	06F 121 111 F	411187.87D		11 53 1 436 823	4326.97D
075 121 113 D	4123.80D		11 53 1 437 040	4326.97D	
077 121 113	4274.87D		11 53 1 437 085	411573.105D ▲	
077 121 113 B	4274.87D		11 53 1 466 174	4235.71D	

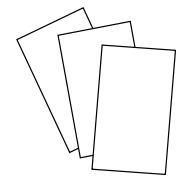

Manufacturer	Manufacturer's Ref.	Wahler-ref.	Manufacturer	Manufacturer's Ref.	Wahler-ref.
	11 53 1 485 847	410263.91D		90 411 948	4177.92D
	11 53 1 501 173	410263.91D		92 062 728	4189.87D
	11 53 1 702 279	4519.95D		92 067 408	4189.87D
	11 53 1 704 704	4594.90D		96 143 939	3017.87D2
	11 53 1 710 056	4516.85D	<b>CHRYSLER</b>	04494 469	3000.90
	11 53 1 710 953	4235.80D		04778 975	4158.80D
	11 53 1 712 043	4238.92D		0489 2642 AC	410871.80D ▲
	11 53 1 713 040	4235.80D		3156283	3000.83
	11 53 1 720 033	4516.85D		4693 117 AA	410263.91D
	11 53 1 720 306	4516.85D		4778 975	4158.80D
	11 53 1 721 002	4236.88D		5098 918 AA	4281.87D
	11 53 1 721 003	4236.88D		5202 8185 AB	3000.90
	11 53 1 727 145	4237.80D		52028185	3000.90
	11 53 1 729 720	4516.85D		5278 144 AA	410262.91D
	11 53 1 729 841	4516.85D		6801 3949 AA	4833.100D
	11 53 1 731 486	4516.70D		MD 194988	410180.82D
	11 53 1 733 803	4236.92D		T 069 7157	4147.80D
	11 53 1 739 755	410792.95D			
	11 53 1 743 528	4238.92D	<b>CITROËN</b>	1336 A7	3431.80D
	11 53 1 743 542	4238.92D		1336 AA	410075.79D ▲
	11 53 2 243 126	4237.80D		1336 N5	3463.89D
	11 53 2 244 151	4237.80D		1336 Q1	3463.89D
	11 53 2 246 199	4237.80D		1336 Q2	410184.89D
	11 53 2 246 825	4237.88D		1336 Z0	410705.89D
	11 53 7 502 779	4508.105D		1337 26	3053.75
	11 53 7 509 227	4326.97D		1338 11	3136.88D50
	11 53 7 510 959	4337.105D		1338 21	4821.89D
	11 53 7 511 083	4236.92D		1338 23	4446.83D
	11 53 7 511 580	4236.88D		1338 26	4450.89D
	11 53 7 536 655	410086.97D0		1338 38	410058.84D
	11 53 7 544 788	410086.97D0		1338 39	4450.83D
	11 53 7 549 476	410086.97D0		1338 44	3136.88D50
	11 53 7 550 172	410087.97D0		1338 71	4447.85D
	11 53 7 552 403	411574.102D ▲		1338 72	4447.80D
	11 53 7 586 885	4508.105D		1338 90	4174.82D
	11 53 7 596 787	410263.91D		1338 A0	3483.89D
	11 53 7 601 158	410766.103D0 ▲		1338 F5	3497.88D
	11 53 7 791 072	410231.82D		5454410R	3033.78D
	11 53 9 055 587	3344.80		5474546	6010.88D
	13 54 1 730 682	7129.00D ▲		5490459C	3033.78D
				75441833	3033.78D
<b>BUGATTI</b>	271990009-00	4618.70		79 100 111 01	3136.82D50
	27199003-00	4618.82		79 100 118 73	3053.75
				79 100 118 80	3136.88D50
<b>BUICK</b>	93235636	410520.92D ▲		79 100 143 90	3136.82D50
				79 100 165 60	3136.82D50
<b>CATERPILLAR</b>	4 N 6958	4256.80D		91 500 723	3061.82
	4 N 6959	4256.80D		93 501 145	4147.80D
	9 L 9119	4256.80D		93 501 386	4147.80D
	9 L 9652	4256.80D		95 492 929	3033.78D
	9 N 5020	4256.80D		95 495 311	3033.84D ▲
	9 N 5065	4256.80D		96 006 231	4821.89D
	9 N 5121	4256.80D		96 049 146	3136.88D50
	9 N 5488	4256.80D		96 050 286 80	3136.88D50
				96 057 136	3136.88D50
<b>CHEVROLET</b>	606 203 02 75	4176.85D		96 058 051	4447.85D
	9 698 4104	4431.105D		96 108 092	4450.89D



## Cross References

Manufacturer	Manufacturer's Ref.	Wahler-ref.	Manufacturer	Manufacturer's Ref.	Wahler-ref.
CITROËN	96 118 108	4447.80D	DODGE	9011 0080	410864.83D0
	96 145 00 980	410058.84D		5080 146 AB	410171.87D
	96 159 513	4147.80D		F 150.204.050.011	2391.75
	96 160 901	4446.83D		F 281.200.050.020	2389.75/1
	96 171 780 80	3136.82D50			
	96 300 66 780	3463.89D			
	96 300 666 80	3483.89D			
DACIA	77 00 101 179	126104 ▲	EVOBUS	83 129 996 050	4105.83D
	77 00 866 387	126104 ▲			
	77 00 872 554	3466.89D			
	82 00 374 994	411043.89D			
	82 00 400 554	411039.83D			
	82 00 558 758	411039.83D			
	82 00 558 783	411043.89D	FENDT	F 150 204 050 10	2391.75
	82 00 561 420	126104 ▲		F 150 204 050 11	2391.75
	82 00 660 882	3166.89D		F 281 200 050 20	2389.75/1
	82 00 772 985	3466.89D		X 815 090 002 000	2391.75
	82 00 954 288	411039.83D		X 815 090 003 000	2389.75/1
DAEWOO	110 200 03 15	4276.87D	FIAT	13 0707 7080	6031.88D
	606 203 02 75	4176.85D		2828 6103	6010.92D
	90 354 822	4144.92D		406 2141	3000.83
	90 411 948	4177.92D		406 2172	3000.83
	92 061 279	4180.82D		406 5540	3000.83
	92 062 728	4189.87D		408 6415	3000.83
	92 067 408	4189.87D		411 4572	6010.92D
	96 143 939	3017.87D2		413 8169	3000.83
				415 4312	3023.87D
				415 4313	3023.87D
				4218 6500	3345.79
DAF	075 0562	4619.80	422 0309	4033.82D	
	129 3885 / F75-85-95	411133.80D	423 5333	6010.92D	
	166 1375 / CF 75	411135.87D	423 5533	6010.92D	
	168 4900 / CF 75	411135.83D	424 0878	6010.92D	
	225 070	3029.83	426 3597	6010.92D	
	295 024	4619.80	434 0878	6010.95D	
	750 562	4619.80	435 1196	4091.82D	
			440 9254	4091.82D	
DAIHATSU	90048-33021-000	3119.88	443 7481	4033.82D	
	90048-33029-000	4126.88	4641 7962	410515.88D	
	90048-33047	410182.84D	4646 4992	3481.88D	
	90048-33056	410182.84D	4646 6123	4247.80D	
	90048-33078	410179.84D	4647 7717	6035.92D	
	90048-33083	410179.84D	465 5782	4008.74D	
	90048-33088	410201.80D	4651 3506	3481.88D	
	90048-33092	410179.84D	4652 0219	6031.97D	
	90916-03040-000	3119.82	4652 0785	410513.88D	
	90916-03046-000	4103.82D	4652 2664	3163.88D	
	90916-03090-000	3478.82D	4652 3118	3151.87D	
			4652 3733	3481.88D	
			4652 5581	4246.80D	
DETROIT DIESEL	8929878	4619.86	4653 6104	3164.88	
			4654 6375	410512.88D	
DEUTZ-FAHR	0117 2667	4094.71/1	467 4169	4008.74D	
	0117 2668	4094.71/1	4673 7644	3151.87D	
	1227 0073	2393.75	4675 8586	410591.88D	
	1227 0074	2391.75	4677 6216	3481.88D	
	1285 0152	4007.80D	4677 6217	3163.88D	
	1285 1663	4007.80D	4677 6218	3164.88	
			4678 5392	410589.88D	
			4679 0294	410511.88D	
		4680 4764	410994.88D		

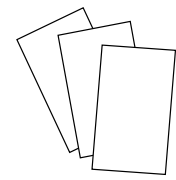

Manufacturer	Manufacturer's Ref.	Wahler-ref.	Manufacturer	Manufacturer's Ref.	Wahler-ref.
	4681 8413	3431.80D		762 5346	3431.80D
	470 3624	4008.74D		762 5347	3431.80D
	470 3625	4008.74D		762 6622	3361.87D
	475 0024	4008.79D		762 8417	3360.87D
	482 3226	4008.74D		762 8527	3355.80D
	482 6602	4151.76D		762 8799	6033.88
	5 0032 9622	4174.82D		765 5732	6035.92D
	50 415 0562	410081.79D		765 6384	3373.80D
	547 4546	6010.88D		765 6385	3373.80D
	5518 7784	410049.88D		765 6567	4022.82D1
	5519 3669	410090.88D		769 2450	3383.87
	5519 4029	410090.88D		769 6535	3383.87
	5519 4271	410048.88D		772 1399	4434.80D
	5519 9402	410588.88D		772 2107	3485.87D
	5520 2176	410090.88D		772 9959	410007.87D
	5520 2373	410048.88D		774 1883	3302.80D
	5520 2510	410049.88D		774 8867	6031.92D
	5520 3388	410049.88D		775 9596	3484.87D
	5521 5006	410871.80D ▲		777 0236	4436.80D
	5523 9819	410090.88D		777 0416	3301.80D
	592 1206	410692.71D		777 3790	410956.83D
	594 2240	3355.80D		779 1178	410516.88D
	595 0116	3159.82D		779 4132	3300.80D
	595 1985	6016.92		779 4218	410513.88D
	595 1987	6016.92		8242 0013	6031.92D
	595 8828	6033.88		8243 6410	6031.92D
	596 6787	3361.87D		8246 5533	6031.92D
	596 9749	3361.87D		8247 7919	6031.92D
	599 2746	6031.92D		907 0701	6031.92D
	6056 4101	6031.92D		9150 0723 80	3061.82
	6065 3946	410514.88D		9616 0901 80	4446.83D
	6080 8223	6031.92D		9616 0902 80	4450.83D
	6081 4382	410514.88D		9617 1780 80	3136.82D50
	708 3256	410520.92D ▲		9845 0800	3103.79
	7173 9800	4357.92D		9846 3637	4174.79D
	7174 2133	410229.82D		9849 8831	3116.82D
	7174 4389	4431.105D			
	7175 4778	410049.88D	FORD	0 801 587	4256.87D50
	7177 0832	4431.105D		1 001 993	4270.88D
	730 3174	4151.79D		1 002 788	4264.87D
	730 3615	4151.79D		1 007 754	4457.82D
	7350 2809	411193.82D		1 018 799	4123.80D
	754 0318	4022.82D1		1 031 881	4264.87D
	754 5958	3105.87D		1 032 249	4123.80D
	755 4544	3383.87		1 086 282	410131.88D ▲
	756 4583	3159.82D		1 096 283	3497.88D
	757 0837	6031.97D		1 096 699	4264.87D
	757 6281	6040.88		1 211 553	4457.82D
	758 1200	3109.87D		1 303 374	4457.82D
	758 1201	3109.87D		1 306 004	4483.82D
	758 9135	3105.87D		1 345 512	4825.98D
	7581 635	3109.82D		1 351 716	4825.98D
	759 7659	3431.80D		1 452 357	3004.88D1
	759 9824	3431.80D		1 472 378	3004.92D1
	761 3433	3378.80		1 473 089	410016.98D
	761 5234	3159.82D		1 473 090	410016.98D
	761 5235	3159.82D		1 497 689	3021.88D50

## Cross References

Manufacturer	Manufacturer's Ref.	Wahler-ref.	Manufacturer	Manufacturer's Ref.	Wahler-ref.
FORD	1 509 953	3021.88D50	GM	800 572	3021.88D50
	1 517 858	3021.88D50		800 573	3021.88D50
	1 518 627	3004.74		800 574	3021.88D50
	1 520 969	3021.88D50		81SF 8575 EA	3021.88D50
	1 607 993	3004.74		81SF 8575 FA	3021.88D50
	1 612 191	4147.80D		84FF 8575 BA	4256.87D50
	1 635 905	3021.88D50		85HF 8575 AA	3021.88D50
	1 649 194	3021.88		891F 8575 AA	3004.88D1
	1 663 819	4270.88D		89BM 8575 AC	3004.92D1
	1 712 228	4483.82D		89BM 8575 AD	3004.92D1
	3 257 449	3119.88		89FF 8575 AA	4270.88D
	3 396 924	4639.82D		89FF 8575 AB	410131.88D
	3 599 763	4639.82D		89TM 8575 AA	4270.88D
	3 893 570	4639.82D		91XM 8575 AA	3021.88D50
	3 902 514	4639.82D		928M 8575 AE	4270.88D
	4 176 181	4639.82D		948M 8575 AA	4270.88D
	4 188 498	4639.82D		95VW 8575 AB	4264.87D
	4 356 548	3100.92D ▲		95VW 8575 AC	4264.87D
	4M5G 6L721 GA	4825.98D		95VW 8B607GA	6037.95D
	4M5G 6L721 GB	4825.98D		95WM 8575 AA	3100.88D
	4M5G 8575 ZA	4483.82D		96MM 8575 A1A	4457.82D
	4M5G 8575 ZB	4483.82D		96MM 8575 BD	4457.82D
	5 004 887	3021.88D50		96MM 8575 BE	4457.82D
	5 004 890	3004.92D1		F42Z 8575 BA	4639.82D
	5 004 891	3004.92D1		KL01 15 171 A	4639.82D
	6 058 444	4256.92D50		XM34 8575 AA	4639.82D
	6 058 784	3053.75		XM34 8575 AB	4639.82D
	6 072 016	6010.95D		XS7Q 8575 AA	3497.88D
	6 077 895	6010.95D		YU3E 8575 BA	3100.92D
	6 077 896	6010.95D			
	6 077 897	6010.95D		02 898 440	3054.92D50
	6 077 898	6010.95D		02 898 688	3054.87D50
	6 077 985	6010.95D		08 966 483	4255.82D
	6 085 917	3021.88D50		08 966 485	4255.87D
	6 085 918	3021.88D50		12 615 097	411193.82D
	6 100 372	4256.87D50		12 622 410	411193.82D
	6 100 629	3021.92D50		12 992 692	4459.92D
	6 100 630	3021.88D50		21 018 811	411193.82D
	6 106 381	4256.87D50		24 405 922	4431.105D
	6 124 378	4256.87D50		24 420 652	4175.92D
	6 144 361	6010.88D		24 420 728	4297.92D
	6 153 501	4270.88D		24 435 781	4201.92D
	6 169 774	410131.88D		24 447 862	4433.92D
	6 176 366	4256.87D50		24 456 401	411578.92D ▲
	6 182 480	4147.80D		55 182 499	410588.88D
	6 201 207	3021.88D50		55 202 510	410049.88D
	6 201 247	3021.88D50		55 577 072	4431.105D
6 526 879	3004.92D1	9 108 106		4151.76D	
6 588 962	4270.88D	9 110 719		3470.89D50	
6 758 566	3100.92D	9 112 305		410517.89D	
6 866 389	4270.88D	9 128 786		4207.92D	
6 994 257	3100.88D	9 129 907		4242.92D	
691F 8575 BA	3004.92D1	9 161 123		4174.79D	
7 072 643	4158.80D	9 543 786		4193.92D	
7 215 818	6037.95D	90 009 956		4115.92D	
7S7G 6L721 AA	410016.98D	90 067 918	4255.92D		
7S7G 6L721 AB	410016.98D	90 108 636	6010.95D		

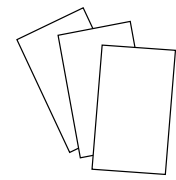

Manufacturer	Manufacturer's Ref.	Wahler-ref.	Manufacturer	Manufacturer's Ref.	Wahler-ref.
	90 156 558	4115.92D			
	90 200 836	3017.92D2	<b>HOLDER</b>	111 727	3000.83
	90 220 435	4164.92D		HD 035 A01	3000.83
	90 232 012	4144.92D			
	90 242 277	6031.100D	<b>HONDA</b>	19300-P08-014	410224.78D
	90 277 288	6031.105D		19300-PA0-003	3119.82
	90 352 677	4168.92D		19300-PB2-003	3119.82
	90 354 822	4164.92D		19300-PB2-004	3119.82
	90 357 303	6031.88D		19300-PB2-013	3119.82
	90 410 665	4144.82D		19300-PB2-014	3119.82
	90 410 897	4175.92D		19300-PB2-024	3119.82
	90 411 948	4177.92D		19300-PB2-811	3119.82
	90 412 901	4178.92D		19300-PB2-812	3119.82
	90 443 472	4164.92D		19300-PB2-815	3119.82
	90 443 473	4144.82D		19300-PB2-816	3119.82
	90 486 128	4180.82D		19300-PB2-817	3119.82
	90 501 081	4183.92D		19300-PDA-E01	410224.78D
	90 501 699	4183.82D		19300-PE0-013	4269.78D
	90 502 201	4175.92D		19300-PE0-024	4269.78D
	90 509 110	4237.80D		19300-PJ7-003	410224.78D
	90 529 846	4188.92D		19300-PJ7-004	410224.78D
	90 536 262	411578.92D ▲		19300-PLZ-004	4269.78D
	90 536 501	411578.92D ▲		19300-PM3-003	410224.78D
	90 537 453	411193.82D		19300-PM3-004	410224.78D
	90 537 605	411193.82D		19300-PR3-003	410224.78D
	90 537 811	411193.82D		19300-PT0-003	410224.78D
	90 570 620	4459.92D		19300-PT0-004	410224.78D
	90 572 899	4198.92D		19301-P07-306	410224.82D
	90 573 326	4208.92D		19301-P07-316	410224.82D
	90 573 926	4201.92D		19301-P08-000	410224.78D
	91 153 670	4158.80D		19301-P08-305	410224.78D
	91 159 950	3466.89D		19301-P08-306	410224.78D
	91 160 168	410517.83D		19301-P08-315	410224.78D
	91 160 216	126104 ▲		19301-P08-316	410224.78D
	9158251	411579.92D ▲		19301-P10-307	410224.78D
	92 063 300	4177.92D		19301-P1K-307	410224.78D
	92 063 300	4194.92D		19301-PAA-305	410224.78D
	93 177 343	410588.88D		19301-PAA-306	410224.78D
	93 179 136	410049.88D		19301-PDF-305	410224.78D
	93 181 245	411578.92D ▲		19301-PLC-305	410224.78D
	93 19 3581	410588.88D		19301-PLC-315	410224.78D
	93 198 017	410517.83D		19301-PNA-003	410225.78D
	93 198 035	411476.83D ▲		19301-PWA-305	410224.82D
	93 198 289	411476.83D ▲		19301-PZA-305	410224.82D
	93 198 317	411476.83D ▲		19301-RAF-003	410226.78D
	93 198 576	411476.83D ▲		19301-RAF-004	410226.78D
	93 198 646	411476.83D ▲		19301-REA-305	410224.78D
	93 275 736	410520.92D ▲		19301-RME-305	410224.78D
	94 372 762	3468.88D		19301-RNA-305	410224.82D
	94 580 182	410183.82D		19301-RNA-306	410224.82D
	96 610 574	410183.88D		19301-RNA-307	410224.82D
	97 087 130	3467.85D		19301-RP3-305	410224.78D
	97 094 283	3004.82			
			<b>HYUNDAI</b>	25500-22600	410351.88D
<b>HAKO</b>	69015347	4264.87D		25500-23001	410348.82D
<b>HOLDEN</b>	92 063 300	4177.92D		25511-29000	4446.83D

## Cross References

Manufacturer	Manufacturer's Ref.	Wahler-ref.	Manufacturer	Manufacturer's Ref.	Wahler-ref.	
INNOCENTI	34 402 115	3004.82		9843 2310	4166.79D	
	65 540 40601	3044.80		9843 3497	4165.79D	
INTER. HARV. IHC	3059 676 R 1	4017.82		9846 3637	4174.79D	
	3059 676 R 91	4017.82		9846 7516	4166.79D	
	3059 676 R 92	4017.82		9846 7517	4163.79D	
	3228 046 R 2	4017.82		9849 2868	4163.74D	
	3228 046 R1	4017.82		9849 2873	4163.74D	
	84247900	6010.75D		9849 8322	4622.82D0	
				9849 8322 Kit	410763.82D	
ISUZU	5-86000-349-0	410224.78D		9943 1512	4619.86	
	5-86000-350-0	410224.78D		JAGUAR	C28067	4006.82D
	5-86008138	410224.82D			C33012	4006.82D
	5-86012-056	410224.78D			C37129	4006.82D
	5-86014-381-0	410224.78D		JEEP	04494469	3000.90
	5-86018-963	410224.78D			5175583AB	4630.87D ▲
	5-86018-964-0	410224.78D			52028185AB	3000.90
	5-86019-507-0	410224.78D		T 069 7157	4147.80D	
	5-86019-513-0	410224.78D		JOHN DEERE	AT 22961	3000.83
	8-79312-726-0	3467.85D			AT 22963	3000.90
	8-94123-295-0	3468.88D			RE 33705	3000.90
	8-94123-295-1	3468.88D	KIA	OK2A-15-171	410352.82D	
	8-94360-227-0	3467.85D		OK2C0-15-171A	410352.88D	
	8-94372-762-0	3468.88D		OK710-15-171	3498.88D	
	8-97087-130-2	3467.85D		OK9FC-15-171	3498.88D	
	94 207 217	3004.82		KE5D3-15-171	3498.88D	
	94 214 962	4022.82D		KHE41-15-171	410352.82D	
IVECO	413 8769	3000.83	KOMATSU	2871 591 M	4520.80D	
	468 4390	4008.79D		2872 578 M	4530.80	
	470 3088	4008.79D	LADA	21080-13060-10	3333.87	
	471 6264	4152.79D		2108-13060-10	3333.87	
	473 8169	4165.79D		21081-3060-11	3333.87	
	474 9724	4105.75D		21215-13060-15	4446.83D	
	477 0246	4174.79D		LANCIA	4652 0785	410513.88D
	480 4321	4166.79D	4652 2664		3163.88D	
	480 7492	4152.79D	4654 6375		410512.88D	
	482 3211	4174.79D	4679 0294		410511.88D	
	483 1783	4152.79D	599 9818		3431.80D	
	483 7166	4174.79D	754 0318		4022.82D1	
	50 032 9622	4174.82D	758 1201		3109.82D	
	50 401 7209	3171.82D	758 1636		3109.82D	
	50 404 5799	3169.79D	758 9135		3105.87D	
	50 408 4365	3169.79D	779 4218		410513.88D	
	50 409 6443	4619.86	7910247116	4122.87D		
	50 409 6443 Kit	410608.86D	8234 2688	3356.80D		
	50 413 2246	410075.79D ▲	9616 0901 80	4446.83D		
	50 415 0562	410081.79D	LANDROVER	GTS 303	4147.80D	
	50 425 8346	410289.81D		RTC 6673	4158.80D	
	50 432 0545	410289.81D		LEXUS	90916-03079	411545.82D ▲
	50 438 7382	410937.82D ▲			90916-03081	411545.82D ▲
6131 6592	4162.79D					
6131 8373	4162.79D					
730 3615	4151.79D					
809 6735	4174.79D					
9842 0718	4163.79D					
9842 4854	4165.79D					

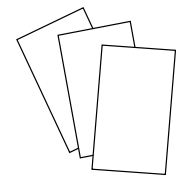

Manufacturer	Manufacturer's Ref.	Wahler-ref.	Manufacturer	Manufacturer's Ref.	Wahler-ref.
LIEBHERR	90916-03144	4480.82D		8173-99-152 A	3499.88D
	90916-03145	4480.82D		8173-99-152 B	3119.88D3
				8173-99-152 B	3499.88D
	738 0513	4530.80		8AB1-15-171	3498.88D
			8AB3 15 171	4006.82D	
LOMBARDINI				8AB5-15-171	3498.88D
	1000208309	4007.80D		8AB7-15-171	3499.82D
	104 9195 092	4008.79D		8AB8-15-171	3498.88D
	9195 057	4007.80D		8AB9-15-171	3499.82D
	9195 1240	4007.80D		8ABA-15-171	3499.88D
	ED0091951240S	4007.80D		8ABB-15-171	3499.88D
				8ABB-15-171A	3499.88D
MACK	657 GC 324 A-P80	411045.82D		8ABC-15-171	3499.82D
MAN				8ABD-15-171	3499.88D
	51.06402.0034	4150.79D50		8ABE-15-171	3498.88D
	51.06402.0042	4150.71D50		8AG1-15-171	3468.88D
	51.06402.0043	4150.79D50		8AG1-15-171A	3468.88D
	51.06402.0044	4150.79D50		8AG2-15-171	3468.88D
	51.06402.0049	4150.79D50		8AG2-15-171A	3468.88D
	51.06402.0050	4150.79D50		8AG3-15-171	3498.88D
	51.06402.0051	4150.79D50		8AG4-15-171	3119.88D3
	51.06402.0052	4150.71D50		8AG4-15-171	3499.88D
	51.06402.0053	4150.79D50		8AG5-15-171	3498.88D
	51.06402.0056	4150.79D50		8AG6-15-171	3468.88D
	51.06402.0057	4150.71D50		8AG7-15-171	3468.88D
	51.06402.0058	4150.83D50		8AG8-15-171	3468.88D
	51.06402.0060	4150.83D50		8AGX-15-171	4639.82D
	51.06402.0061	4150.79D50		8AK1-15-171	3498.88D
	51.06402.0062	4150.71D50		8AN1-15-171	3498.88D
	51.06402.0063	4150.83D50		8AU1-15-171	3498.88D
	51.06402.0064	4150.79D50		8AU-15-171	3498.88D
	51.06402.0065	4150.71D50		8AX1-15-171	3119.88D3
	51.06402.0066	4150.83D50		8AX1-15-171	3499.88D
	51.06402.0067	4150.79D50		8AZ1-15-171	3468.88D
	51.06402.0068	4150.71D50		AB6-15-171	3498.88D
	51.06402.0069	4150.79D50		B366-15-171	3499.82D
	81.06401.0019	410864.71D0		B3H3-15-171	3499.82D
	81.06401.0037	410864.79D0		B3H8-15-171A	3499.82D
	81.06401.0038	410864.83D0		B541-15-171	3119.88D3
	81.06401.0042	410864.71D0		B541-15-171	3499.88D
	81.06401.0045	410864.83D0		B6H-15-171	3498.88D
	81.06401.0046	410864.79D0		B6H-15-171 A	3498.88D
81.06401.6002	4373.70 ▲		BP6F-15-171	3498.88D	
MAZDA				BPD3-15-171	3498.88D
	0223-15-171	3499.82D		E5D3-15-171	3498.88D
	0419-15-171	3499.82D		F201-15-171	3498.88D
	0419-99-152	3499.82D		FS05-15-171	4639.82D
	1A51-15-171	4639.82D		HE 41-99-152 A	3119.88D3
	1E03-15-171	3004.92D1		HE 41-99-152 C	3119.82D3
	1E05-15-171 A	4457.82D		HE 41-99-152C	3499.82D
	1E07-15-171	410131.88D		HE 41-99-152D	3499.82D
	1E07-15-171 A	410131.88D		KL01-15-171	4639.82D
	8124-99-152	3119.82		KL01-15-171 A	4639.82D
	8173-15-152 C	3499.88D		RF03-15-171A	3468.88D
	8173-15-171	3499.88D		ZZ40-15-171	3498.88D
	8173-99-152	3499.88D			
	8173-99-152 A	3119.88D3	MERCEDES-BENZ	000 203 64 75	3000.80

## Cross References

Manufacturer	Manufacturer's Ref.	Wahler-ref.	Manufacturer	Manufacturer's Ref.	Wahler-ref.
MERCEDES-BENZ	001 203 58 75	3000.80		005 203 59 75	4472.83D
	001 203 69 75	4083.83D50		100 200 05 15	4078.87D
	001 203 90 75	4078.79D		100 200 07 15	4078.79D
	001 203 91 75	4078.87D		102 200 08 15	4078.87D
	002 203 04 75	4083.83D50		102 200 14 15	4078.87D
	002 203 16 75	4078.71D		102 200 15 15	4078.87D
	002 203 31 75	4078.71D		102 200 19 15	4078.87D
	002 203 32 75	4105.83D		110 200 01 11	4078.87D
	002 203 35 75	4078.79D		110 200 05 15	4078.87D
	002 203 37 75	4078.79D		110 200 09 15	4078.71D
	002 203 38 75	4078.79D		110 200 19 15	4078.92D
	002 203 39 75	4105.71D		111 200 03 15	4276.87D
	002 203 45 75	4105.83D		111 200 08 15	4279.87D
	002 203 46 75	4078.79D		111 200 09 15	4275.87D
	002 203 47 75	4105.83D		111 200 17 15	4414.87D
	002 203 49 75	4105.83D		111 203 02 75	4275.87D
	002 203 53 75	4083.83D50		111 203 03 75	4276.87D
	002 203 56 75	4105.83D		111 203 05 75	4279.87D
	002 203 59 75	4105.83D		111 203 06 75	4275.87D
	002 203 72 75	4078.79D		111 203 08 75	4275.87D
	002 203 75 75	4117.80D		111 203 10 75	4414.87D
	002 203 76 75	4078.87D		112 200 00 15	4281.87D
	002 203 78 75	4078.79D		112 200 01 15	4298.87D
	002 203 79 75	4105.83D		112 203 02 75	4281.87D
	002 203 80 75	4117.80D		112 203 03 75	4298.87D
	002 203 81 75	4078.87D		116 200 00 15	4064.75D
	002 203 82 75	4064.75D		116 200 02 15	4233.84D
	002 203 90 75	4105.83D		116 200 03 15	4137.80D
	003 203 14 75	4105.83D		119 200 00 15	4278.80D
	003 203 22 75	3000.80		119 203 01 75	4278.80D
	003 203 28 75	4105.83D		120 200 00 15	4517.87D
	003 203 29 75	4105.71D		120 203 02 75	4517.87D
	003 203 31 75	4105.83D		160 200 03 15	3142.90D
	003 203 32 75	4105.71D		166 203 00 75	411576.87D ▲
	003 203 73 75	4105.83D		166 203 01 75	411576.87D ▲
	003 203 74 75	4105.71D		166 203 02 75	411576.87D ▲
	003 203 78 75	4105.83D		266 203 02 75	411577.80D ▲
	003 203 79 75	4105.71D		266 203 04 75	411577.80D ▲
	003 203 82 75	4233.84D		266 203 06 75	411577.80D ▲
	003 203 91 75	4105.79D		271 200 00 15	3457.90D
	003 203 92 75	4105.79D		271 200 01 15	410389.103D ▲
	003 203 98 75	4176.80D		271 200 02 15	410389.103D ▲
	004 203 09 75	4176.85D		271 200 03 15	410389.103D ▲
	004 203 39 75	4137.80D		271 203 03 75	3457.90D
	004 203 40 75	4137.80D		272 200 00 15	4834.100D
	004 203 65 75	4078.65D		272 200 01 15	4834.100D
	004 203 83 75	4105.83D		272 200 04 15	4834.100D
	004 203 84 75	4105.71D		272 200 05 15	4833.100D
	004 203 85 75	4105.79D		272 200 06 15	4829.100D ▲
	004 203 86 75	4078.92D		273 200 01 15	4829.100D ▲
005 203 17 75	4619.75		273 200 02 15	4833.100D	
005 203 18 75	4619.80		273 200 04 15	4829.100D ▲	
005 203 19 75	4619.86		373 203 70 75	4105.83D	
005 203 26 75	4105.83D		601 200 00 15	4176.85D	
005 203 27 75	4105.79D		601 200 01 15	4176.80D	
005 203 28 75	4105.71D		602 200 00 15	4176.80D	
005 203 29 75	4123.80D		603 200 00 15	4176.80D	

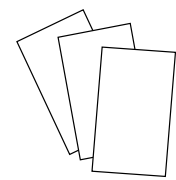

Manufacturer	Manufacturer's Ref.	Wahler-ref.	Manufacturer	Manufacturer's Ref.	Wahler-ref.
	603 203 04 74	4280.80D		MD 345617	4637.76D
	603 203 04 74	4280.85D		MD 348937	410180.82D
	604 203 00 75	4280.85D		MD 351495	410180.82D
	605 203 00 75	4280.80D		MD 360320	4637.82D
	606 203 01 75	4176.80D		MD 972903	3119.88D4
	606 203 02 75	4176.85D		MD 972905	3119.82D4
	606 203 05 75	4176.85D		MD 972908	3119.82D4
	607 200 00 15	3004.82		MD 997217	3119.82D4
	611 200 02 15	410171.87D		MD 997219	3119.82D4
	611 200 07 15	410171.87D		MD 997220	3119.82D4
	611 203 04 75	410171.87D		MD 997221	3119.88
	611 203 05 75	410171.87D		MD 997221	3119.88D4
	611 203 15 75	410171.87D		MD 997224	4638.82D
	611 203 19 75	410171.87D		MD 997461	3119.88D4
	615 200 13 15	4117.80D		MD 997602	3119.82D4
	616 200 04 15	4117.80D		MD 997603	3119.82D4
	617 200 03 15	4049.80D		MD 997605	4638.76D
	617 200 11 15	4049.80D		MD 997606	4638.82D
	617 200 18 15	4049.80D1		MD 997607	3119.82D4
	628 203 01 75	4309.92D		MD 997608	3119.88D4
	642 200 02 15	4490.87D		MD 997644	410180.82D
	642 200 02 15	4835.87D		ME 190303	4637.76D
	642 200 03 15	4630.87D ▲		ME 191593	4637.76D
	642 200 04 15	4835.87D		ME 200262	4637.76D
	642 200 07 15	4832.87D ▲		ME 220538	410180.82D
	642 200 08 15	410055.87D ▲		ME 241816	410180.82D
	642 200 20 15	4490.87D		ME 999295	4638.82D
	646 200 00 15	410174.92D		MN 980137	3472.87D
	646 200 11 15	410174.92D			
	646 200 12 15	410171.87D		<b>MULTICAR</b>	0820117806
646 203 02 75	410174.92D		4008540	4264.87D	
660 200 03 15	3146.90D				
<b>MITSUBISHI</b>	M-474877	3470.89D50	<b>MWM</b>	1215 2752	2391.75
	M-863985	3470.89D50		1215 2766	2391.75
	MD 001370	3119.82D4		6 052 5 010 005 0	4520.75
	MD 005131	3119.88D4		6 052 5 011 001 1	2391.75
	MD 005371	3119.82D4		6 052 5 011 002 4	2393.75
	MD 008086	3119.82D4		6 052 5 011 004 2	2391.75
	MD 015299	4638.82D		6 052 5 100 41	2393.75
	MD 075460	3119.82D4		9 225 0 757 014 6	4351.79
	MD 094120	4638.82D		9 229 8 757 004 6	4588.75/1
	MD 117759	3119.82D4		9 407 0 757 002 4	3145.79D
	MD 126168	3119.82D4	<b>NEOPLAN</b>	0303.191.04	4520.80D
	MD 158570	4637.82D			
	MD 164541	4637.76D	<b>NISSAN</b>	11060-00Q0C	411475.89D ▲
	MD 165630	4637.82D		11060-00Q0E	411475.89D ▲
	MD 170031	4637.76D		11060-00Q0K	411442.83D ▲
	MD 174233	410180.82D		11060-00Q0S	411442.83D ▲
	MD 175746	4637.82D		11060-00QAF	410538.89D
	MD 194988	410180.82D		11060-00QAJ	411040.83D
	MD 310106	4637.82D		11060-00QAL	411475.89D ▲
	MD 315301	4637.82D		11060-AW300	410517.89D
	MD 317015	4637.76D		11060-BN700	411043.89D
	MD 335170	4637.82D		11061-00Q0A	411476.83D ▲
	MD 337408	4637.82D		11061-00Q0B	411476.83D ▲
	MD 338234	4637.82D		11061-00Q0D	411039.83D



## Cross References

Manufacturer	Manufacturer's Ref.	Wahler-ref.	Manufacturer	Manufacturer's Ref.	Wahler-ref.
NISSAN	11061-00Q0E	411043.89D		13 38 003	4242.92D
	11061-00Q0G	411476.83D ▲		13 38 007	411193.82D
	11061-00Q0K	411476.83D ▲		13 38 008	411193.82D
	11061-00Q0L	411476.83D ▲		13 38 009	4201.92D
	11061-00Q1B	411476.83D ▲		13 38 015	4297.92D
	11061-00QAB	410517.83D		13 38 015 old number	3017.92D50
	11061-00QAC	410517.83D		13 38 016	3054.92D50
	11061-00QAD	410517.89D		13 38 017	4433.92D
	11061-00QAE	3166.89D		13 38 018	3054.87D50
	11061-00QAG	411043.89D		13 38 020	410048.88D
	11061-00QAL	411043.89D		13 38 024	4255.82D
	11061-00QAM	411039.83D		13 38 030	3004.82
	21200-01B00	3044.90D1		13 38 033	4255.87D
	21200-2H600	3118.82D1		13 38 034	411193.82D
	21200-2H605	3118.88D1		13 38 038	4255.92D
	21200-41B00	3118.82D1		13 38 039	410049.88D
	21200-4M500	3478.82D		13 38 041	3054.87D50
	21200-57J00	410176.82D0		13 38 042	3021.88D50
	21200-57J05	410176.88D0		13 38 046	4115.92D
	21200-57J15	410176.82D0		13 38 049	4144.92D
	21200-6F900	4821.89D		13 38 050	4164.92D
	21200-6F901	4821.89D		13 38 052	3017.92D2
	21200-77A00	4634.76		13 38 054	4144.92D
	21200-77A05	3478.82D		13 38 056	3468.88D
	21200-77A60	4634.76		13 38 057	4164.92D
	21200-77A61	4634.76		13 38 059	4144.82D
	21200-77A63	4634.76		13 38 060	4168.92D
	21200-77A65	3478.82D		13 38 062	4144.82D
	21200-77A66	3478.82D		13 38 063	4164.92D
	21200-78515	3118.88D1		13 38 067	4175.92D
	21200-85G00	3118.82D1		13 38 068	4177.92D
	21200-85G05	3118.88D1		13 38 069	4180.82D
	21200-85G06	3118.88D1		13 38 073	4178.92D
	21200-86J00	3478.82D		13 38 075	3467.85D
	21200-86J01	3478.82D		13 38 076	4237.80D
	21200-90J00	3478.82D		13 38 077	3004.82
	21200-90J10	3478.82D		13 38 079	4183.92D
	21200-99B03	3118.82D1		13 38 080	4183.82D
	21200-9F600	3478.82D		13 38 084	4175.92D
	21200-BX000	410488.88D		13 38 087	4188.92D
	21200-ED000	411241.82D		13 38 096	4459.92D
	21200-ED00A	411241.82D		13 38 097	4201.92D
	21200-G3100	3000.83		13 38 100	4198.92D
	21200-P7500	3118.88D1		13 38 154	410049.88D
	21200-P7901	3118.82D1		13 38 178	4431.105D
	21200-P7905	3118.88D1		13 38 275	410049.88D
	21200-P7906	3118.88D1		13 38 331	4208.92D
21200-P7990	3118.82D1		13 38 427	411193.82D	
21200-P7991	3118.88D1		13 38 466	4158.80D	
21200-V0100	3118.82D1		13 38 478	4194.92D	
21200-V0105	3118.88D1		13 41 002	6010.95D	
21200-V0200	3118.82D1		13 41 011	6031.100D	
21200-V0201	3118.82D1		13 41 017	6031.105D	
21200-V0205	3118.88D1		13 41 028	6031.88D	
21200-V0206	3118.88D1		1338 001	411578.92D ▲	
			1338 004	411579.92D ▲	
			1338 098	411578.92D ▲	
OPEL	13 38 002	4207.92D			

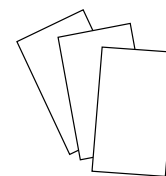

Manufacturer	Manufacturer's Ref.	Wahler-ref.	Manufacturer	Manufacturer's Ref.	Wahler-ref.
	44 00 106	4151.76D		1338 13	4447.85D
	44 02 719	3470.89D50		1338 19	4447.80D
	44 04 305	410517.89D		1338 20	4147.80D
	44 08 334	3466.89D		1338 21	4821.89D
	44 08 928	410517.83D		1338 23	4446.83D
	44 09 180	126104 ▲		1338 25	4147.80D
	44 32 983	410517.83D		1338 26	4450.89D
	44 33 121	411476.83D ▲		1338 37	3136.82D50
	44 34 144	411476.83D ▲		1338 38	410058.84D
	44 34 190	411476.83D ▲		1338 39	4450.83D
	44 49 134	411476.83D ▲		1338 44	3136.88D50
	44 49 506	411476.83D ▲		1338 71	4447.85D
	45 00 823	4174.79D		1338 72	4447.80D
	47 08 757	410588.88D		1338 83	3136.82D50
	48 11 586	4189.87D		1338 90	4174.82D
	63 38 004	4428.92D		1338 A0	3483.89D
	63 38 018	4431.105D		1338 C8	4821.89D
	63 38 022	410588.88D		1338 F5	3497.88D
	63 38 028	4459.92D		5474546	6010.88D
	63 38 039	410048.88D		79 100 118 73	3053.75
	63 38 050	4357.92D		79 102 461 13	4122.87D
	6338 005	411578.92D ▲		79 102 471 16	4122.87D
	6338 035	411578.92D ▲		91 500 723 80	3061.82
	93 18 4200	410048.88D		91 500 724 80	3061.88
				96 057 087 80	3136.88D50
<b>PACCAR</b>	129 3885 / F75-85-95	411133.80D		96 057 136 80	3136.88D50
	166 1375 / CF 75	411135.87D		96 090 230 80	4147.80D
	168 4900 / CF 75	411135.83D		96 108 092 80	4450.89D
				96 108 093 80	4450.89D
<b>PEGASO</b>	222730	4619.75		96 160 902 80	4450.83D
	770275	4078.75D		96 196 379 80	3136.88D50
	770662	4619.75		96 272 785 80	4447.80D
				96 272 814 80	4447.85D
<b>PERKINS</b>	7483490	3000.75		96 300 666 80	3483.89D
	PF 52.842	3000.80		96 300 667 80	3463.89D
				96 472 659 80	410705.89D
<b>PEUGEOT</b>	1264 32	6031.92D		96á485 426 80	410184.89D
	1264 33	6035.92D			
	1264 50	6031.88D	<b>PORSCHE</b>	928.106.129.06	4161.83
	1264 50	6031.92D		928.106.129.16	4161.83
	1336 A7	3431.80D		928.106.129.17	4161.83
	1336 AA	410075.79D ▲		944.106.019.00	4256.83D60
	1336 N5	3463.89D		944.106.129.05	4256.80D60
	1336 Q1	3463.89D		944.106.129.05	4256.83D60
	1336 Q2	410184.89D		944.606.481.00	6010.92D
	1336 Z0	410705.89D		955.106.113.00	4455.80D
	1337 26	3053.75		996.106.013.54	4249.83D
	1337 27	3136.88D50		996.106.013.55	4249.83D
	1337 30	3136.82D50		996.106.013.56	4249.83D
	1337 34	4122.87D		996.106.013.57	4249.83D
	1337 47	3061.82		996.106.121.53	4249.83D
	1337 48	3159.82D		996.106.125.52	4249.83D
	1337 49	3061.88			
	1337 64	4147.80D	<b>RENAULT</b>	00 24 774 033	4529.70
	1337 65	3033.84D ▲		11 06 023 09R	411477.89D ▲
	1337 68	4147.80D		11 06 030 26R	411442.83D ▲
	1338 11	3136.88D50		11 06 055 36R	411442.83D ▲

## Cross References

Manufacturer	Manufacturer's Ref.	Wahler-ref.	Manufacturer	Manufacturer's Ref.	Wahler-ref.
RENAULT	50 00 684 865	410828.82D0		77 01 348 373	3470.89D50
	50 00 684 865 Kit	410828.82D		77 01 348 374	3029.86
	50 00 691 267	410828.86D0		77 01 348 376	3029.83
	50 00 691 267 Kit	410828.86D		77 01 349 173	4122.87D
	50 00 694 785	4529.83D0		77 01 349 415	4122.87D
	50 00 816 924	4151.76D		77 01 474 248	410518.89D
	50 01 855 520	4619.82		77 01 474 249	410530.89D
	50 10 284 184	411045.82D		82 00 039 885	411043.89D
	50 10 295 225	4596.83D		82 00 074 346	410517.89D
	50 10 295 225 2x Kit	410758.83D		82 00 074 349	410517.83D
	50 10 447 161	4619.86		82 00 112 054	410538.89D
	50 10 553 100	4619.86		82 00 171 021	411043.89D
	60 01 543 366	3466.89D		82 00 244 023	411039.83D
	60 05 000 004	2391.75		82 00 244 402	411043.89D
	60 05 004 616	2391.75		82 00 248 531	411477.89D ▲
	60 05 004 616	2393.75		82 00 267 349	411042.89D
	74 31 397 947	4272.90D		82 00 374 994	411043.89D
	74 36 842 409	4272.90D		82 00 380 898	411475.89D ▲
	74 39 180 811	4272.90D		82 00 400 553	411040.83D
	77 00 024 756	2389.75/1		82 00 400 554	411039.83D
	77 00 024 756	2391.75		82 00 403 437	411476.83D ▲
	77 00 101 179	126104 ▲		82 00 558 751	411040.83D
	77 00 109 641	410530.89D		82 00 558 758	411039.83D
	77 00 110 716	3166.89D		82 00 558 766	411042.89D
	77 00 112 491	410518.89D		82 00 558 779	411477.89D ▲
	77 00 260 959	4449.84D		82 00 558 783	411043.89D
	77 00 575 874	3029.83		82 00 561 420	126104 ▲
	77 00 619 931	3029.86		82 00 656 419	411475.89D ▲
	77 00 657 955	4122.87D		82 00 656 420	411475.89D ▲
	77 00 665 226	4147.80D		82 00 660 882	3166.89D
	77 00 697 157	4147.80D		82 00 674 368	410517.89D
	77 00 703 136	4122.87D		82 00 674 369	410517.83D
	77 00 710 657	4122.87D		82 00 699 392	411475.89D ▲
	77 00 722 762	3029.86		82 00 703 139	411475.89D ▲
	77 00 723 945	3470.89D50		82 00 703 140	411476.83D ▲
	77 00 727 190	3029.89		82 00 772 985	3466.89D
	77 00 730 540	3029.89		82 00 801 567	411476.83D ▲
	77 00 742 617	3469.91D		82 00 801 570	411475.89D ▲
	77 00 858 087	4147.80D		82 00 801 571	411475.89D ▲
	77 00 858 802	3469.91D		82 00 907 229	411475.89D ▲
	77 00 862 200	4147.80D		82 00 907 234	411475.89D ▲
	77 00 866 387	126104 ▲		82 00 907 239	411476.83D ▲
	77 00 866 896	3470.89D50		82 00 907 243	411476.83D ▲
	77 00 868 274	4446.83D		82 00 954 285	411043.89D
	77 00 868 980	3174.89D		82 00 954 288	411039.83D
	77 00 872 314	3470.89D50		82 00 954 289	411481.89D ▲
	77 00 872 554	3466.89D		82 00 954 328	411442.83D ▲
77 00 872 635	3466.89D				
77 01 026 647	4008.79D				
77 01 035 736	3116.82D	ROLLS-ROYCE	11 53 7 586 885	4508.105D	
77 01 038 494	4446.83D				
77 01 039 156	3116.82D	ROVER			
77 01 042 512	4174.79D		GTS 282	3000.83	
77 01 068 770	411241.82D		GTS 287	4158.80D	
77 01 348 068	3029.89		GTS 298	3000.90	
77 01 348 139	3053.85		GTS 299	4821.89D	
77 01 348 372	3136.82D50		GTS 301	410808.88D	
			PEL 000170	410806.88D	
			PEL 10009 EVA	4158.80D	

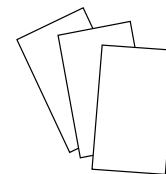

Manufacturer	Manufacturer's Ref.	Wahler-ref.	Manufacturer	Manufacturer's Ref.	Wahler-ref.	
SAAB	PEL 10016	410808.88D		032 121 110 L	410475.87D	
	PEL 10019 EVA	4821.89D		032 121 110 P	3143.87D	
	12 61 5097	411193.82D		032 121 121 G	410475.87D	
	12 62 2410	411193.82D		032 121 121 K	410475.87D	
	24 435 102	4357.92D		03G 121 111 A	4820.87D	
	30 57 7561	4154.88D		03G 121 113	3472.87D	
	45 03 017	4175.92D		03G 121 113 A	4820.87D	
	46 23 815	4175.92D		03L 121 111 AE	410845.87D	
	47 72 190	4193.92D		03L 121 111 R	410845.92D	
	55 20 3388	410049.88D		03L 121 111 S	410845.92D	
	640972	411578.92D ▲		03L 121 113 B	410537.92D	
	75 02 297	4022.82D		03L 121 114 B	410536.92D	
	75 17 345	4154.82D		044 121 113	4264.87D	
	83 89 512	4022.88D		050 121 113 C	3141.87D	
	85 47 572	6010.88D		056 121 113 D	4264.87D	
	85 69 23	6010.92D		068 121 113 H	4253.87D	
	88 17 298	4154.88D		06D 121 111 G	411186.87D	
	88 17 538	4154.82D		06F 121 111 F	411187.87D	
	88 22 025	4154.88D		075 121 113 D	4123.80D	
	90 53 7453	411193.82D		191 959 481 A	6017.95D	
	90 53 7811	411193.82D		191 959 481 B	6020.95D	
	91 66 687	4154.88D		191 959 481 C	6017.95D	
	91 94 101	4154.88D		1H0 959 481	6037.95D	
	91 94 242	4154.88D		1H0 959 481 B	6037.95D	
	93 20 284	4022.92D		251 959 481	6017.95D	
	93 37 551	4022.82D		321 959 481 A	6017.95D	
	95 26 518	6010.95D		321 959 481 C	6017.95D	
	SAURER	154.0943.426		4530.80	321 959 481 D	6017.95D
		461.0943		4030.70	6U0 959 481 A	6017.95D
					823 959 481	6010.92D
SCANIA	1 347 594	4224.80D	823 959 481 A	6010.92D		
	1 358 995	4223.83D	823 959 481 F	6010.92D		
	1 395 856	4520.75	823 959 481 G	6010.95D		
	1 404 924	4223.83D	823 959 481 L	6010.92D		
	1 404 925	4224.80D	867 959 481	6039.95D		
	1 423 450	4223.83D	CA 032.221.01	3000.83		
	1 423 451	411004.80D	EA03222101	3023.87D		
	1 431 979	4223.75D	SE 020 032 221 A	3361.87D		
	1 458 198	4224.75D	SE 021 032 221 B	4256.87D50		
	1 745 449	4224.80D	SE 021 952 600 A	6020.92D		
	1 799 757	411004.80D	SKODA	032 121 110 B	3143.87D	
	1 800 909	411004.80D		032 121 110 B	410989.87D	
	1 849 060	411004.80D		032 121 110 F	3167.83D	
	2 832 814	4520.80D		032 121 110 J	410989.87D	
	238 156	3096.75		032 121 110 L	410475.87D	
	283 281	4520.80D		032 121 110 P	3143.87D	
	525 076	3096.75		032 121 113	4253.87D	
	550 275	4520.80D		032 121 121 G	410475.87D	
	SEAT	0004218650		3345.79	032 121 121 K	410475.87D
		030 121 113 B		4264.84D	03G 121 111 A	4820.87D
032 121 110 B		3143.87D		03G 121 113	3472.87D	
032 121 110 B		410989.87D		03G 121 113 A	4820.87D	
032 121 110 F		3167.83D		03L 121 111 AE	410845.87D	
032 121 110 J		410989.87D		03L 121 111 R	410845.92D	
				03L 121 111 S	410845.92D	
				03L 121 113 B	410537.92D	

## Cross References

Manufacturer	Manufacturer's Ref.	Wahler-ref.	Manufacturer	Manufacturer's Ref.	Wahler-ref.
SKODA	03L 121 114 B	410536.92D	SUZUKI	21210-AA120	411716.88D ▲
	044 121 113	4264.87D		21210-AA140	411715.84D ▲
	050 121 113 C	3141.87D		21210-AA150	411716.88D ▲
	056 121 113	4253.87D		21210-AA160	411715.84D ▲
	056 121 113 D	4264.87D		31753-0100	3000.83
	068 121 113 H	4253.87D			
	06D 121 111 G	411186.87D		17570-74000	410228.82D
	06F 121 111 F	411187.87D		17570-740001	410228.82D
	077 121 113	4274.87D		17570-86CA0	4446.83D
	077 121 113 B	4274.87D		17600-77820	410183.88D
	078 121 113	4274.87D		17600-83810	410228.82D
	078 121 113 C	4274.87D		17600-83811	410228.82D
	078 121 113 F	4274.87D		17600-83820	410228.82D
	078 121 113 J	4274.87D		17600-83821	410228.82D
	113 095 0	3032.80		17600-83821-000	3119.82
	113 095 075	6010.75D		17600-83822	410228.82D
	113 095 090	6010.92D		17600-83823	410228.82D
	113 095 091	3032.80		17600-85811	410183.82D
	114 095 090	3032.88		17600-85821	410183.88D
	115 095 070	6010.88D		17600-85830	410228.82D
	1H0 959 481 B	6037.95D		17600-85831	410228.82D
	441 044 330 186	6017.95D		17670-50G00	410183.82D
	823 959 481 G	6010.95D		17670-50G10	410183.88D
	823 959 481 H	6010.95D		17670-50G20	410183.88D
	823 959 481 K	6010.95D		17670-63J00	410229.82D
	867 959 481	6039.95D		17670-65D00	410229.82D
		17670-66G00	4446.83D		
SMART	0003179V009	3142.90D	17670-67H00	410183.88D	
	0003179V010	3142.90D	17670-73000	410228.82D	
	0004698V002	3146.90D	17670-73020	410228.82D	
	0004698V003	3146.90D	17670-73021	410228.82D	
	660 200 05 15	3146.90D	17670-76A00	410183.82D	
	Q0003179V010000000	3142.90D	17670-76A01	410183.82D	
			17670-76G00	410183.82D	
STEYR	217.87.71	6010.75D	17670-76G10	410183.88D	
	311.00.06.0065	4368.87	17670-77E00	410229.82D	
	609E060013	4520.80D	17670-77E10	4639.82D	
		17670-77E11	4639.82D		
SUBARU	21200-AA071	410230.78D	17670-77G00	410183.82D	
	21200-AA072	410230.78D	17670-77G10	410183.88D	
	21200-AA140	411715.84D ▲	17670-78E00	3468.88D	
	21200-AA150	411716.88D ▲	17670-82810-000	410183.82D	
	21200-AA160	411715.84D ▲	17670-83000	410228.82D	
	21200-AA170	411743.82D ▲	17670-83001	410228.82D	
	21200-AA200	411716.88D ▲	17670-83010	410228.82D	
	21200-AA220	411715.84D ▲	17670-83011	410228.82D	
	21200-AA230	411715.84D ▲	17670-85020	410183.88D	
	21200-KA010	410183.82D	17670-85C00	410229.82D	
	21200-KA050	410183.82D	17690 84A00	411043.89D	
	21200-KA070	410183.88D	17690-67JG0	410538.89D	
	21200-KA150	410183.82D	17690-79J50	410049.88D	
	21200-KA151	410183.82D	17690-84A10	411043.89D	
	21200-KA152	410183.82D	17690-84A11	411043.89D	
	21200-KA153	410183.82D	17690-84A50-000	411039.83D	
	21200-KA154	410183.82D	17690-84A51	411477.89D ▲	
	21210-AA030	410230.78D	17690-84E50-000	410588.88D	
	21210-AA080	411743.82D ▲			

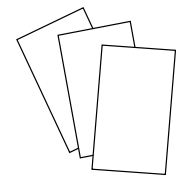

Manufacturer	Manufacturer's Ref.	Wahler-ref.	Manufacturer	Manufacturer's Ref.	Wahler-ref.
TALBOT	131 666.00	4026.89		13 38 018	3054.87D50
				13 38 024	4255.82D
TOYOTA	16340-54010	3477.88D		13 38 033	4255.87D
	90080-23002	3478.82D		13 38 038	4255.92D
	90916-03040	3119.88		13 38 041	3054.87D50
	90916-03040	3119.88D5		13 38 042	3021.88D50
	90916-03043	3477.88D		13 38 046	4115.92D
	90916-03043	4126.88		13 38 049	4144.92D
	90916-03046	4103.82D		13 38 052	3017.92D2
	90916-03055	3119.82D5		13 38 057	4164.92D
	90916-03060	3478.82D		13 38 060	4168.92D
	90916-03062	3477.88D		13 38 063	4164.92D
	90916-03062	4126.88		13 38 067	4175.92D
	90916-03065	4103.82D		13 38 068	4177.92D
	90916-03069	4103.82D		13 38 069	4180.82D
	90916-03072	3477.88D		13 38 073	4178.92D
	90916-03075	4480.82D		13 38 076	4237.80D
	90916-03078	3119.88D5		13 38 079	4183.92D
	90916-03079	411545.82D ▲		13 38 084	4175.92D
	90916-03081	411545.82D ▲		13 38 096	4459.92D
	90916-03084	4480.82D		13 38 466	4158.80D
	90916-03088	410178.82D		13 41 002	6010.95D
	90916-03090	3478.82D		13 41 011	6031.100D
	90916-03093	410231.82D		13 41 017	6031.105D
	90916-03095	3478.82D		13 41 028	6031.88D
	90916-03096	3478.82D		21 018 811	411193.82D
	90916-03097	410181.82D		24 405 922	4431.105D
	90916-03099	3477.88D		24 420 728	4297.92D
	90916-03101	410178.82D		24 435 781	4201.92D
	90916-03106	3477.88D		24 447 862	4433.92D
	90916-03109	3478.82D		24 456 401	411578.92D ▲
	90916-03115	3478.82D		40 191 1858	3021.88
	90916-03118	410181.82D		55 182 499	410588.88D
	90916-03120	410178.82D		55 202 510	410049.88D
90916-03122	410201.80D		55 577 072	4431.105D	
90916-03123	410231.82D		9 108 106	4151.76D	
90916-03125	4480.82D		9 110 719	3470.89D50	
90916-03129	4480.82D		90 009 956	4115.92D	
90916-03133	4480.82D		90 067 918	4255.92D	
90916-03136	4480.82D		90 108 636	6010.95D	
90916-03140	4480.82D		90 242 277	6031.100D	
90916-03144	4480.82D		90 264 080	4144.92D	
90916-03145	4480.82D		90 277 288	6031.105D	
90916-54010	3477.88D		90 357 303	6031.88D	
90916-A3001	4480.82D		90 411 948	4177.92D	
90916-A3002	4480.82D		90 509 110	4237.80D	
90916-A3003	4480.82D		90 529 846	4188.92D	
SU001-0223	4446.83D		90 536 262	411578.92D ▲	
			90 536 501	411578.92D ▲	
VALTRA	114 470	4351.79		90 537 453	411193.82D
	149 620	4588.75/1		90 537 605	411193.82D
				90 537 811	411193.82D
VAUXHALL	02 898 440	3054.92D50		90 570 620	4459.92D
	08 966 485	4255.87D		90 572 899	4198.92D
	12 615 097	411193.82D		90 573 326	4208.92D
	12 622 410	411193.82D		90 573 926	4201.92D
	13 38 016	3054.92D50		91 153 670	4158.80D

## Cross References

Manufacturer	Manufacturer's Ref.	Wahler-ref.	Manufacturer	Manufacturer's Ref.	Wahler-ref.
VAUXHALL	91 159 950	3466.89D		059 121 113 A	4006.82D
	91 160 216	126104 ▲		059 121 113 B	4006.82D
	91 28 786	4207.92D		062 121 111 A	3145.79D
	91 29 907	4242.92D		062 121 111 B	3145.79D
	91 61 123	4174.79D		068 121 113 A	4256.71
	93 177 343	410588.88D		068 121 113 H	4253.87D
	93 179 136	410049.88D		069 121 113	4116.87D1
	93 181 245	411578.92D ▲		069 121 113 A	4116.87D1
	93 198 035	411476.83D ▲		06B 121 113 A	3141.87D
	93 198 289	411476.83D ▲		06C 121 111 C	4814.92D
	93 198 317	411476.83D ▲		06C 121 111 D	4814.92D
	93 198 576	411476.83D ▲		06C 121 111 E	4814.92D
	93 198 646	411476.83D ▲		06D 121 111 G	411186.87D
	94 372 762	3468.88D		06F 121 111 F	411187.87D
	97 087 130	3467.85D		070 121 114	4430.87D
			075 121 113 D	4123.80D	
VM	3 901 2004 F	4158.80D		076 121 113 A	4123.70
	4 901 2012 F	4030.70		077 121 113	4274.87D
VOLKSWAGEN				077 121 113 B	4274.87D
	00A 121 113	4275.87D		077 121 113 C	4274.82D
	022 121 113	4455.80D		078 121 113	4274.87D
	025 121 113 D	4155.87D		078 121 113 C	4274.87D
	025 121 113 E	4155.87D		078 121 113 F	4274.87D
	025 121 113 F	4155.87D		078 121 113 J	4274.87D
	030 121 113	4264.84D		07K 121 113 B	4488.80D0
	030 121 113 B	4264.84D		07Z 121 111	4572.105D
	032 121 110 B	3143.87D		191 959 481 A	6017.95D
	032 121 110 B	410989.87D		191 959 481 B	6020.95D
	032 121 110 C	410989.80D		191 959 481 C	6017.95D
	032 121 110 F	3167.83D		1H0 959 481	6037.95D
	032 121 110 J	410989.87D		1H0 959 481 B	6037.95D
	032 121 110 L	410475.87D		251 959 481	6017.95D
	032 121 110 P	3143.87D		251 959 481 G	6087.87D
	032 121 113	4253.87D		251 959 481 H	6087.87D
	032 121 121 G	410475.87D		251 959 481 K	6087.87D
	032 121 121 K	410475.87D		321 959 481 A	6017.95D
	035 121 113	4088.80D		321 959 481 B	6020.95D
	035 121 113 B	4088.87D		321 959 481 C	6017.95D
	036 121 113	3091.92D		321 959 481 D	6017.95D
	036 121 113 A	3091.92D		321 959 481 E	6020.95D
	036 121 113 B	3091.92D		321 959 481 G	6020.95D
	037 121 113	4256.83D60		372 959 481 1	6039.95D
	03G 121 111 A	4820.87D		6U0 959 481 A	6017.95D
	03G 121 113	3472.87D		701 959 481	6037.87D
	03G 121 113 A	4820.87D		701 959 481 C	6037.81D
	03L 121 111 AE	410845.87D		701 959 481 J	6037.87D
	03L 121 111 R	410845.92D		811 959 481	6024.95D
	03L 121 111 S	410845.92D		823 959 481	6010.92D
	03L 121 113 B	410537.92D		823 959 481 A	6010.92D
	03L 121 114 B	410536.92D		823 959 481 F	6010.92D
	044 121 113	4264.87D		823 959 481 G	6010.95D
	050 121 113 C	3141.87D		823 959 481 H	6010.95D
	052 121 113 A	3091.92D		823 959 481 K	6010.95D
	056 121 113	4253.87D		823 959 481 L	6010.92D
	056 121 113 A	4256.80D		867 959 481	6039.95D
	056 121 113 D	4264.87D		893 959 481	6024.95D
	056 121 113 E	4256.71		9.407.0.757.002.4	3145.79D

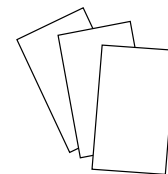

Manufacturer	Manufacturer's Ref.	Wahler-ref.		
<b>VOLVO</b>	J 16 340 540 10	410201.80D		
	J 90 916 030 46	4103.82D		
	J 90 916 030 99	3477.88D		
	J 90 916 540 10	3477.88D		
	1 219 150	4089.82D		
	1 544 097	4038.76D		
	1 544 098	4038.81D		
	1 544 389	4038.65D		
	1 544 683	4619.82		
	1 661 993	4619.75		
	1 665 694	4619.86		
	267 235	3029.89		
	271 417	4272.90D		
	271 664	4272.90D		
	272 246	4116.87D1		
	272 335	4206.90D		
	273 307	4089.92D		
	273 458	4022.88D		
	273 459	4089.87D		
273 480	4122.87D			
273 728	4088.87D			
273 950	4038.65D			



## Cross References

Wahler-ref.	Manufacturer's Ref.	Manufacturer	Wahler-ref.	Manufacturer's Ref.	Manufacturer	
126104 ▲	44 09 180	OPEL	3000.90	04494 469	CHRYSLER	
	77 00 101 179	DACIA		04494469	JEEP	
	77 00 101 179	RENAULT		5202 8185 AB	CHRYSLER	
	77 00 866 387	DACIA		52028185	CHRYSLER	
	77 00 866 387	RENAULT		52028185AB	JEEP	
	82 00 561 420	DACIA		AT 22963	JOHN DEERE	
	82 00 561 420	RENAULT		GTS 298	ROVER	
	91 160 216	GM		RE 33705	JOHN DEERE	
2389.75/1	77 00 024 756	RENAULT	3004.74	1 518 627	FORD	
	F 281 200 050 20	FENDT		1 607 993	FORD	
	F 281.200.050.020	DODGE	3004.82	13 38 030	OPEL	
	X 815 090 003 000	FENDT		13 38 077	OPEL	
2391.75	1215 2752	MWM	3004.88D1	34 402 115	INNOCENTI	
	1215 2766	MWM		52 06 139	ASTON MARTIN	
	1227 0074	DEUTZ-FAHR		607 200 00 15	MERCEDES-BENZ	
	6 052 5 011 001 1	MWM		94 207 217	ISUZU	
	6 052 5 011 004 2	MWM		97 094 283	GM	
	60 05 000 004	RENAULT		1 452 357	FORD	
	60 05 004 616	RENAULT		891F 8575 AA	FORD	
	77 00 024 756	RENAULT		3004.92D1	1 472 378	FORD
	F 150 204 050 10	FENDT			1E03-15-171	MAZDA
	F 150 204 050 11	FENDT			5 004 890	FORD
	F 150.204.050.011	DODGE			5 004 891	FORD
	X 815 090 002 000	FENDT			6 526 879	FORD
	X815.090.002.000	AGCO			691F 8575 BA	FORD
	2393.75	1227 0073			DEUTZ-FAHR	89BM 8575 AC
6 052 5 011 002 4		MWM	89BM 8575 AD		FORD	
6 052 5 100 41		MWM	3017.87D2	96 143 939	CHEVROLET	
60 05 004 616		RENAULT		96 143 939	DAEWOO	
3000.75	7483490	PERKINS	3017.92D2	13 38 052	OPEL	
3000.80	000 203 64 75	MERCEDES-BENZ		13 38 052	VAUXHALL	
	001 203 58 75	MERCEDES-BENZ		90 200 836	GM	
	003 203 22 75	MERCEDES-BENZ		3017.92D50	13 38 015 old number	OPEL
	PF 52.842	PERKINS	3021.88		1 649 194	FORD
3000.83	105.00.01.064.00	ALFA ROMEO		40 191 1858	VAUXHALL	
	105.00.01.064.01	ALFA ROMEO	3021.88D50	1 497 689	FORD	
	111 727	HOLDER		1 509 953	FORD	
	21200-G3100	NISSAN		1 517 858	FORD	
	3156283	CHRYSLER		1 520 969	FORD	
	31753-0100	SUBARU		1 635 905	FORD	
	406 2141	FIAT		13 38 042	OPEL	
	406 2172	FIAT		13 38 042	VAUXHALL	
	406 5540	FIAT		5 004 887	FORD	
	408 6415	FIAT	6 085 917	FORD		
	413 8169	FIAT	6 085 918	FORD		
	413 8769	IVECO	6 100 630	FORD		
	AT 22961	JOHN DEERE	6 201 207	FORD		
	CA 032.221.01	SEAT				
	GTS 282	ROVER				
	HD 035 A01	HOLDER				

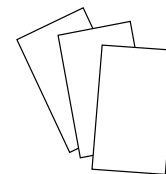

Wahler-ref.	Manufacturer's Ref.	Manufacturer	Wahler-ref.	Manufacturer's Ref.	Manufacturer
	6 201 247	FORD		13 38 041	OPEL
	800 572	FORD		13 38 041	VAUXHALL
	800 573	FORD			
	800 574	FORD	<b>3054.92D50</b>	02 898 440	GM
	81SF 8575 EA	FORD		02 898 440	VAUXHALL
	81SF 8575 FA	FORD		13 38 016	OPEL
	85HF 8575 AA	FORD		13 38 016	VAUXHALL
	91XM 8575 AA	FORD			
<b>3021.92D50</b>	6 100 629	FORD	<b>3061.82</b>	1337 47	PEUGEOT
				91 500 723	CITROËN
<b>3023.87D</b>	415 4312	FIAT		91 500 723 80	PEUGEOT
	415 4313	AUTOBIANCHI		9150 0723 80	FIAT
	415 4313	FIAT	<b>3061.88</b>	1337 49	PEUGEOT
	EA03222101	SEAT		91 500 724 80	PEUGEOT
<b>3029.83</b>	225 070	DAF	<b>3067.83</b>	6071 0617	ALFA ROMEO
	77 00 575 874	RENAULT			
	77 01 348 376	RENAULT	<b>3091.92D</b>	036 121 113	AUDI
<b>3029.86</b>	77 00 619 931	RENAULT		036 121 113	VOLKSWAGEN
	77 00 722 762	RENAULT		036 121 113 A	AUDI
	77 01 348 374	RENAULT		036 121 113 A	VOLKSWAGEN
<b>3029.89</b>	267 235	VOLVO		036 121 113 B	AUDI
	77 00 727 190	RENAULT		036 121 113 B	VOLKSWAGEN
	77 00 730 540	RENAULT		052 121 113 A	AUDI
	77 01 348 068	RENAULT	<b>3096.75</b>	052 121 113 A	VOLKSWAGEN
<b>3032.80</b>	113 095 0	SKODA		238 156	SCANIA
	113 095 091	SKODA	<b>3100.88D</b>	525 076	SCANIA
<b>3032.88</b>	114 095 090	SKODA		6 994 257	FORD
<b>3033.78D</b>	5454410R	CITROËN		95WM 8575 AA	FORD
	5490459C	CITROËN	<b>3100.92D</b>	4 356 548	FORD
	75441833	CITROËN		6 758 566	FORD
	95 492 929	CITROËN		YU3E 8575 BA	FORD
<b>3033.84D ▲</b>	1337 65	PEUGEOT	<b>3103.79</b>	9845 0800	FIAT
	95 495 311	CITROËN			
<b>3044.80</b>	65 540 40601	INNOCENTI	<b>3105.87D</b>	754 5958	FIAT
<b>3044.90D1</b>	21200-01B00	NISSAN		7545 9580	AUTOBIANCHI
<b>3053.75</b>	1337 26	CITROËN		758 9135	FIAT
	1337 26	PEUGEOT		758 9135	LANCIA
	6 058 784	FORD		7581 3190	AUTOBIANCHI
	79 100 118 73	CITROËN	<b>3109.82D</b>	758 1201	LANCIA
	79 100 118 73	PEUGEOT		758 1636	LANCIA
<b>3053.85</b>	77 01 348 139	RENAULT		7581 635	FIAT
<b>3054.87D50</b>	02 898 688	GM	<b>3109.87D</b>	758 1200	FIAT
	13 38 018	OPEL		758 1201	FIAT
	13 38 018	VAUXHALL	<b>3116.82D</b>	77 01 035 736	RENAULT
				77 01 039 156	RENAULT
			<b>3118.82D1</b>	9849 8831	FIAT
				21200-2H600	NISSAN

## Cross References

Wahler-ref.	Manufacturer's Ref.	Manufacturer	Wahler-ref.	Manufacturer's Ref.	Manufacturer	
3118.82D1	21200-41B00	NISSAN	3119.88D3	90916-03040	TOYOTA	
	21200-85G00	NISSAN		MD 997221	MITSUBISHI	
	21200-99B03	NISSAN		8173-99-152 A	MAZDA	
	21200-P7901	NISSAN		8173-99-152 B	MAZDA	
	21200-P7990	NISSAN		8AG4-15-171	MAZDA	
	21200-V0100	NISSAN		8AX1-15-171	MAZDA	
	21200-V0200	NISSAN		B541-15-171	MAZDA	
	21200-V0201	NISSAN		HE 41-99-152 A	MAZDA	
3118.88D1	21200-2H605	NISSAN	3119.88D4	MD 005131	MITSUBISHI	
	21200-78515	NISSAN		MD 972903	MITSUBISHI	
	21200-85G05	NISSAN		MD 997221	MITSUBISHI	
	21200-85G06	NISSAN		MD 997461	MITSUBISHI	
	21200-P7500	NISSAN		MD 997608	MITSUBISHI	
	21200-P7905	NISSAN				
	21200-P7906	NISSAN	3119.88D5	90916-03040	TOYOTA	
	21200-P7991	NISSAN		90916-03078	TOYOTA	
	21200-V0105	NISSAN				
	21200-V0205	NISSAN		3136.82D50	1337 30	PEUGEOT
	21200-V0206	NISSAN			1338 37	PEUGEOT
					1338 83	PEUGEOT
3119.82	17600-83821-000	SUZUKI	77 01 348 372		RENAULT	
	19300-PA0-003	HONDA	79 100 111 01		CITROËN	
	19300-PB2-003	HONDA	79 100 143 90		CITROËN	
	19300-PB2-004	HONDA	79 100 165 60	CITROËN		
	19300-PB2-013	HONDA	96 171 780 80	CITROËN		
	19300-PB2-014	HONDA	9617 1780 80	FIAT		
	19300-PB2-024	HONDA				
	19300-PB2-811	HONDA	3136.88D50	1337 27	PEUGEOT	
	19300-PB2-812	HONDA		1338 11	CITROËN	
	19300-PB2-815	HONDA		1338 11	PEUGEOT	
	19300-PB2-816	HONDA		1338 44	CITROËN	
	19300-PB2-817	HONDA		1338 44	PEUGEOT	
	8124-99-152	MAZDA		79 100 118 80	CITROËN	
	90916-03040-000	DAIHATSU		96 049 146	CITROËN	
				96 050 286 80	CITROËN	
				96 057 087 80	PEUGEOT	
		96 057 136		CITROËN		
		96 057 136 80	PEUGEOT			
		96 196 379 80	PEUGEOT			
3119.82D3	HE 41-99-152 C	MAZDA	3141.87D	050 121 113 C	AUDI	
				050 121 113 C	SEAT	
3119.82D4	MD 001370	MITSUBISHI		050 121 113 C	SKODA	
	MD 005371	MITSUBISHI		050 121 113 C	VOLKSWAGEN	
	MD 008086	MITSUBISHI		06B 121 113 A	VOLKSWAGEN	
	MD 075460	MITSUBISHI				
	MD 117759	MITSUBISHI		3142.90D	0003179V009	SMART
	MD 126168	MITSUBISHI			0003179V010	SMART
	MD 972905	MITSUBISHI			160 200 03 15	MERCEDES-BENZ
	MD 972908	MITSUBISHI			Q0003179V010000000	SMART
	MD 997217	MITSUBISHI				
	MD 997219	MITSUBISHI	3143.87D		032 121 110 B	AUDI
	MD 997220	MITSUBISHI		032 121 110 B	SEAT	
	MD 997602	MITSUBISHI		032 121 110 B	SKODA	
MD 997603	MITSUBISHI	032 121 110 B		VOLKSWAGEN		
MD 997607	MITSUBISHI					
3119.82D5	90916-03055	TOYOTA				
3119.88	3 257 449	FORD				
	90048-33021-000	DAIHATSU				

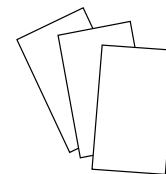

Wahler-ref.	Manufacturer's Ref.	Manufacturer	Wahler-ref.	Manufacturer's Ref.	Manufacturer
	032 121 110 P	AUDI	<b>3344.75</b>	11 53 1 260 720	BMW
	032 121 110 P	SEAT			
	032 121 110 P	SKODA	<b>3344.80</b>	11 53 1 253 248	BMW
	032 121 110 P	VOLKSWAGEN		11 53 1 253 249	BMW
				11 53 9 055 587	BMW
<b>3145.79D</b>	062 121 111 A	VOLKSWAGEN			
	062 121 111 B	VOLKSWAGEN	<b>3345.79</b>	0004218650	SEAT
	9 407 0 757 002 4	MWM		421 8649	AUTOBIANCHI
	9.407.0.757.002.4	VOLKSWAGEN		4218 6500	FIAT
<b>3146.90D</b>	0004698V002	SMART			
	0004698V003	SMART	<b>3355.80D</b>	594 2240	FIAT
	660 200 03 15	MERCEDES-BENZ		762 8527	FIAT
	660 200 05 15	SMART			
			<b>3356.80D</b>	8234 2688	LANCIA
<b>3151.87D</b>	4652 3118	FIAT			
	4673 7644	FIAT	<b>3360.87D</b>	762 8417	FIAT
<b>3159.82D</b>	1337 48	PEUGEOT	<b>3361.87D</b>	596 6787	FIAT
	595 0116	FIAT		596 9749	FIAT
	756 4583	FIAT		762 6622	FIAT
	761 5234	FIAT		SE 020 032 221 A	SEAT
	761 5235	FIAT			
			<b>3373.80D</b>	765 6384	FIAT
<b>3163.88D</b>	4652 2664	FIAT		765 6385	FIAT
	4652 2664	LANCIA			
	4677 6217	FIAT	<b>3378.80</b>	761 3433	FIAT
<b>3164.88</b>	4653 6104	FIAT	<b>3383.87</b>	755 4544	FIAT
	4677 6218	FIAT		769 2450	FIAT
				769 6535	FIAT
<b>3166.89D</b>	11061-00QAE	NISSAN			
	77 00 110 716	RENAULT	<b>3431.80D</b>	1336 A7	CITROËN
	82 00 660 882	DACIA		1336 A7	PEUGEOT
	82 00 660 882	RENAULT		4681 8413	FIAT
				599 9818	LANCIA
<b>3167.83D</b>	032 121 110 F	AUDI		759 7659	FIAT
	032 121 110 F	SEAT		759 9824	FIAT
	032 121 110 F	SKODA		762 5346	FIAT
	032 121 110 F	VOLKSWAGEN		762 5347	FIAT
<b>3169.79D</b>	50 404 5799	IVECO	<b>3457.90D</b>	271 200 00 15	MERCEDES-BENZ
	50 408 4365	IVECO		271 203 03 75	MERCEDES-BENZ
<b>3171.82D</b>	50 401 7209	IVECO	<b>3463.89D</b>	1336 N5	CITROËN
				1336 N5	PEUGEOT
<b>3174.89D</b>	77 00 868 980	RENAULT		1336 Q1	CITROËN
				1336 Q1	PEUGEOT
<b>3300.80D</b>	779 4132	FIAT		96 300 66 780	CITROËN
				96 300 667 80	PEUGEOT
<b>3301.80D</b>	777 0416	FIAT			
			<b>3466.89D</b>	44 08 334	OPEL
<b>3302.80D</b>	774 1883	FIAT		60 01 543 366	RENAULT
				77 00 872 554	DACIA
<b>3333.87</b>	21080-13060-10	LADA		77 00 872 554	RENAULT
	2108-13060-10	LADA		77 00 872 635	RENAULT
	21081-3060-11	LADA		82 00 772 985	DACIA
				82 00 772 985	RENAULT

## Cross References

Wahler-ref.	Manufacturer's Ref.	Manufacturer	Wahler-ref.	Manufacturer's Ref.	Manufacturer
3466.89D	91 159 950	GM	3478.82D	21200-4M500	NISSAN
	91 159 950	VAUXHALL		21200-77A05	NISSAN
3467.85D	13 38 075	OPEL	21200-77A65	NISSAN	
	8-79312-726-0	ISUZU	21200-77A66	NISSAN	
	8-94360-227-0	ISUZU	21200-86J00	NISSAN	
	8-97087-130-2	ISUZU	21200-86J01	NISSAN	
	97 087 130	GM	21200-90J00	NISSAN	
	97 087 130	VAUXHALL	21200-90J10	NISSAN	
			21200-9F600	NISSAN	
3468.88D	13 38 056	OPEL	90080-23002	TOYOTA	
	17670-78E00	SUZUKI	90916-03060	TOYOTA	
	8-94123-295-0	ISUZU	90916-03090	TOYOTA	
	8-94123-295-1	ISUZU	90916-03090-000	DAIHATSU	
	8-94372-762-0	ISUZU	90916-03095	TOYOTA	
	8AG1-15-171	MAZDA	90916-03096	TOYOTA	
	8AG1-15-171A	MAZDA	90916-03109	TOYOTA	
	8AG2-15-171	MAZDA	90916-03115	TOYOTA	
	8AG2-15-171A	MAZDA			
	8AG6-15-171	MAZDA	4646 4992	FIAT	
	8AG7-15-171	MAZDA	4651 3506	FIAT	
	8AG8-15-171	MAZDA	4652 3733	FIAT	
	8AZ1-15-171	MAZDA	4677 6216	FIAT	
	94 372 762	GM			
	94 372 762	VAUXHALL	3481.88D	4646 4992	FIAT
	RF03-15-171A	MAZDA		4651 3506	FIAT
				4652 3733	FIAT
			4677 6216	FIAT	
		3483.89D	1338 A0	CITROËN	
			1338 A0	PEUGEOT	
			96 300 666 80	CITROËN	
			96 300 666 80	PEUGEOT	
3469.91D	77 00 742 617	RENAULT			
	77 00 858 802	RENAULT	3484.87D	775 9596	FIAT
3470.89D50	3 344 616	VOLVO	3485.87D	772 2107	FIAT
	3 345 628	VOLVO			
	44 02 719	OPEL	3497.88D	1 096 283	FORD
	77 00 723 945	RENAULT		1338 F5	CITROËN
	77 00 866 896	RENAULT		1338 F5	PEUGEOT
	77 00 872 314	RENAULT		XS7Q 8575 AA	FORD
	77 01 348 373	RENAULT			
	9 110 719	GM	3498.88D	0K710-15-171	KIA
	9 110 719	VAUXHALL		0K9FC-15-171	KIA
	M-474877	MITSUBISHI		8AB1-15-171	MAZDA
	M-863985	MITSUBISHI		8AB5-15-171	MAZDA
			8AB8-15-171	MAZDA	
3472.87D	03G 121 113	AUDI		8ABE-15-171	MAZDA
	03G 121 113	SEAT		8AG3-15-171	MAZDA
	03G 121 113	SKODA		8AG5-15-171	MAZDA
	03G 121 113	VOLKSWAGEN		8AK1-15-171	MAZDA
	MN 980137	MITSUBISHI		8AN1-15-171	MAZDA
				8AU1-15-171	MAZDA
3477.88D	16340-54010	TOYOTA		8AU-15-171	MAZDA
	90916-03043	TOYOTA		AB6-15-171	MAZDA
	90916-03062	TOYOTA		B6H-15-171	MAZDA
	90916-03072	TOYOTA		B6H-15-171 A	MAZDA
	90916-03099	TOYOTA		BP6F-15-171	MAZDA
	90916-03106	TOYOTA		BPD3-15-171	MAZDA
	90916-54010	TOYOTA		E5D3-15-171	MAZDA
	J 90 916 030 99	VOLKSWAGEN		F201-15-171	MAZDA
	J 90 916 540 10	VOLKSWAGEN			

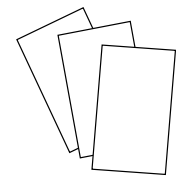

Wahler-ref.	Manufacturer's Ref.	Manufacturer	Wahler-ref.	Manufacturer's Ref.	Manufacturer		
3499.82D	KE5D3-15-171	KIA	4017.82	77 01 026 647	RENAULT		
	ZZ40-15-171	MAZDA		3059 676 R 1	INTER. HARV. IHC		
	0223-15-171	MAZDA		3059 676 R 91	INTER. HARV. IHC		
	0419-15-171	MAZDA		3059 676 R 92	INTER. HARV. IHC		
	0419-99-152	MAZDA		3228 046 R 2	INTER. HARV. IHC		
	8AB7-15-171	MAZDA		3228 046 R1	INTER. HARV. IHC		
	8AB9-15-171	MAZDA		4022.82D	75 02 297	SAAB	
	8ABC-15-171	MAZDA			93 37 551	SAAB	
	B366-15-171	MAZDA			94 214 962	ISUZU	
	B3H3-15-171	MAZDA		4022.82D1	754 0318	FIAT	
	B3H8-15-171A	MAZDA			754 0318	LANCIA	
	HE 41-99-152C	MAZDA			761 5234	ALFA ROMEO	
	HE 41-99-152D	MAZDA			765 6567	FIAT	
	3499.88D	8173-15-152 C		MAZDA	4022.88D	273 458	VOLVO
8173-15-171		MAZDA	83 89 512	SAAB			
8173-99-152		MAZDA	4022.92D	93 20 284		SAAB	
8173-99-152 A		MAZDA		4026.89		131 666.00	TALBOT
8173-99-152 B		MAZDA			4029.81	466 017	VOLVO
8ABA-15-171		MAZDA	4030.70	4 901 2012 F		VM	
8ABB-15-171		MAZDA		461.0943	SAURER		
8ABB-15-171A		MAZDA		4033.82D	422 0309	FIAT	
8ABD-15-171		MAZDA			443 7481	FIAT	
8AG4-15-171		MAZDA	4038.65D	1 544 389	VOLVO		
8AX1-15-171		MAZDA		273 950	VOLVO		
B541-15-171		MAZDA		3 831 426	VOLVO		
4003.86		6050 4230		ALFA ROMEO	424 370	VOLVO	
		4006.82D		059 121 113 A	AUDI	466 127	VOLVO
059 121 113 A	VOLKSWAGEN			4038.71D	875 788	VOLVO	
059 121 113 B	AUDI				4038.76D	1 544 097	VOLVO
059 121 113 B	VOLKSWAGEN		273 951			VOLVO	
8AB3 15 171	MAZDA		273 953	VOLVO			
C28067	JAGUAR	875 787	VOLVO				
C33012	JAGUAR	4038.81D	1 544 098	VOLVO			
C37129	JAGUAR		273 952	VOLVO			
4007.80D	1000208309	LOMBARDINI	4049.80D	617 200 03 15	MERCEDES-BENZ		
	1285 0152	DEUTZ-FAHR		617 200 11 15	MERCEDES-BENZ		
	1285 1663	DEUTZ-FAHR		4049.80D1	617 200 18 15	MERCEDES-BENZ	
	9195 057	LOMBARDINI			4064.75D	002 203 82 75	MERCEDES-BENZ
	9195 1240	LOMBARDINI				116 200 00 15	MERCEDES-BENZ
ED0091951240S	LOMBARDINI	4078.65D	004 203 65 75	MERCEDES-BENZ			
4008.74D	465 5782		FIAT	4078.65D			
	467 4169		FIAT				
	470 3624		FIAT				
	470 3625	FIAT					
	482 3226	FIAT					
4008.79D	104 9195 092	LOMBARDINI					
	468 4390	IVECO					
	470 3088	IVECO					
	475 0024	FIAT					
	6071 3535	ALFA ROMEO					

## Cross References

Wahler-ref.	Manufacturer's Ref.	Manufacturer	Wahler-ref.	Manufacturer's Ref.	Manufacturer
4078.71D	002 203 16 75	MERCEDES-BENZ	410016.98D	1 473 089	FORD
	002 203 31 75	MERCEDES-BENZ		1 473 090	FORD
	110 200 09 15	MERCEDES-BENZ		7S7G 6L721 AA	FORD
4078.75D	770275	PEGASO		7S7G 6L721 AB	FORD
4078.79D	001 203 90 75	MERCEDES-BENZ	410048.88D	13 38 020	OPEL
	002 203 35 75	MERCEDES-BENZ		5519 4271	FIAT
	002 203 37 75	MERCEDES-BENZ		5520 2373	FIAT
	002 203 38 75	MERCEDES-BENZ		63 38 039	OPEL
	002 203 46 75	MERCEDES-BENZ		93 18 4200	OPEL
	002 203 72 75	MERCEDES-BENZ			
	002 203 78 75	MERCEDES-BENZ		410049.88D	13 38 039
100 200 07 15	MERCEDES-BENZ	13 38 154	OPEL		
4078.87D	001 203 91 75	MERCEDES-BENZ		13 38 275	OPEL
	002 203 76 75	MERCEDES-BENZ		17690-79J50	SUZUKI
	002 203 81 75	MERCEDES-BENZ		55 20 3388	SAAB
	100 200 05 15	MERCEDES-BENZ		55 202 510	GM
	102 200 08 15	MERCEDES-BENZ		55 202 510	VAUXHALL
	102 200 14 15	MERCEDES-BENZ		5518 7784	FIAT
	102 200 15 15	MERCEDES-BENZ		5520 2510	ALFA ROMEO
	102 200 19 15	MERCEDES-BENZ		5520 2510	FIAT
	110 200 01 11	MERCEDES-BENZ		5520 3388	FIAT
	110 200 05 15	MERCEDES-BENZ		7175 4778	ALFA ROMEO
				7175 4778	FIAT
				93 179 136	GM
	4078.92D	004 203 86 75	MERCEDES-BENZ		93 179 136
110 200 19 15		MERCEDES-BENZ			
4083.79 •	738 0833	LIEBHERR	410055.87D ▲	642 200 08 15	MERCEDES-BENZ
4083.83D50	001 203 69 75	MERCEDES-BENZ	410058.84D	1338 38	CITROËN
	002 203 04 75	MERCEDES-BENZ		1338 38	PEUGEOT
	002 203 53 75	MERCEDES-BENZ		96 145 00 980	CITROËN
4088.80D	035 121 113	AUDI	410075.79D ▲	1336 AA	CITROËN
	035 121 113	VOLKSWAGEN		1336 AA	PEUGEOT
				50 413 2246	IVECO
4088.87D	035 121 113 B	AUDI	410081.79D	50 415 0562	FIAT
	035 121 113 B	VOLKSWAGEN		50 415 0562	IVECO
	273 728	VOLVO			
4089.82D	1 219 150	VOLVO	410086.97D0	11 53 7 536 655	BMW
	463 433	VOLVO		11 53 7 544 788	BMW
				11 53 7 549 476	BMW
4089.87D	273 459	VOLVO	410087.97D0		
				11 53 7 550 172	BMW
4089.92D	273 307	VOLVO	410090.88D	5519 3669	FIAT
				5519 4029	FIAT
				5520 2176	FIAT
				5523 9819	FIAT
4091.82D	435 1196	FIAT	410131.88D	1 086 282	FORD
	4355 8460	AUTOBIANCHI		1E07-15-171	MAZDA
	440 9254	FIAT		1E07-15-171 A	MAZDA
	4409 2540	AUTOBIANCHI		6 169 774	FORD
4094.71/1	0117 2667	DEUTZ-FAHR		89FF 8575 AB	FORD
	0117 2668	DEUTZ-FAHR			
410007.87D	772 9959	FIAT			

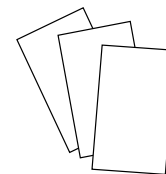

Wahler-ref.	Manufacturer's Ref.	Manufacturer	Wahler-ref.	Manufacturer's Ref.	Manufacturer
<b>410171.87D</b>	5080 146 AB	DODGE	<b>410183.88D</b>	17600-77820	SUZUKI
	611 200 02 15	MERCEDES-BENZ		17600-85821	SUZUKI
	611 200 07 15	MERCEDES-BENZ		17670-50G10	SUZUKI
	611 203 04 75	MERCEDES-BENZ		17670-50G20	SUZUKI
	611 203 05 75	MERCEDES-BENZ		17670-67H00	SUZUKI
	611 203 15 75	MERCEDES-BENZ		17670-76G10	SUZUKI
	611 203 19 75	MERCEDES-BENZ		17670-77G10	SUZUKI
	646 200 12 15	MERCEDES-BENZ		17670-85020	SUZUKI
<b>410174.92D</b>	646 200 00 15	MERCEDES-BENZ	<b>410184.89D</b>	21200-KA070	SUBARU
	646 200 11 15	MERCEDES-BENZ		96 610 574	GM
	646 203 02 75	MERCEDES-BENZ		1336 Q2	CITROËN
<b>410176.82D0</b>	21200-57J00	NISSAN	<b>410201.80D</b>	1336 Q2	PEUGEOT
	21200-57J15	NISSAN		96â485 426 80	PEUGEOT
<b>410176.88D0</b>	21200-57J05	NISSAN	<b>410224.78D</b>	90048-33088	DAIHATSU
<b>410178.82D</b>	90916-03088 90916-03101 90916-03120	TOYOTA TOYOTA TOYOTA		90916-03122	TOYOTA
				J 16 340 540 10	VOLKSWAGEN
			19300-P08-014	HONDA	
<b>410179.84D</b>	90048-33078	DAIHATSU	19300-PDA-E01	HONDA	
	90048-33083	DAIHATSU	19300-PJ7-003	HONDA	
	90048-33092	DAIHATSU	19300-PJ7-004	HONDA	
<b>410180.82D</b>	MD 174233	MITSUBISHI	19300-PM3-003	HONDA	
	MD 194988	CHRYSLER	19300-PM3-004	HONDA	
	MD 194988	MITSUBISHI	19300-PR3-003	HONDA	
	MD 348937	MITSUBISHI	19300-PT0-003	HONDA	
	MD 351495	MITSUBISHI	19300-PT0-004	HONDA	
	MD 997644	MITSUBISHI	19301-P08-000	HONDA	
	ME 220538	MITSUBISHI	19301-P08-305	HONDA	
	ME 241816	MITSUBISHI	19301-P08-306	HONDA	
<b>410181.82D</b>	90916-03097	TOYOTA	19301-P08-315	HONDA	
	90916-03118	TOYOTA	19301-P08-316	HONDA	
<b>410182.84D</b>	90048-33047	DAIHATSU	19301-P10-307	HONDA	
	90048-33056	DAIHATSU	19301-P1K-307	HONDA	
<b>410183.82D</b>	17600-85811	SUZUKI	19301-PAA-305	HONDA	
	17670-50G00	SUZUKI	19301-PAA-306	HONDA	
	17670-76A00	SUZUKI	19301-PDF-305	HONDA	
	17670-76A01	SUZUKI	19301-PLC-305	HONDA	
	17670-76G00	SUZUKI	19301-PLC-315	HONDA	
	17670-77G00	SUZUKI	19301-REA-305	HONDA	
	17670-82810-000	SUZUKI	19301-RME-305	HONDA	
	21200-KA010	SUBARU	19301-RP3-305	HONDA	
	21200-KA050	SUBARU	5-86000-349-0	ISUZU	
	21200-KA150	SUBARU	5-86000-350-0	ISUZU	
	21200-KA151	SUBARU	5-86012-056	ISUZU	
	21200-KA152	SUBARU	5-86014-381-0	ISUZU	
	21200-KA153	SUBARU	5-86018-963	ISUZU	
	21200-KA154	SUBARU	5-86018-964-0	ISUZU	
	94 580 182	GM	5-86019-507-0	ISUZU	
			5-86019-513-0	ISUZU	
			19301-P07-306	HONDA	
		19301-P07-316	HONDA		
		19301-PWA-305	HONDA		
		19301-PZA-305	HONDA		
		19301-RNA-305	HONDA		



## Cross References

Wahler-ref.	Manufacturer's Ref.	Manufacturer	Wahler-ref.	Manufacturer's Ref.	Manufacturer	
410224.82D	19301-RNA-306	HONDA	410348.82D	25500-23001	HYUNDAI	
	19301-RNA-307	HONDA		410351.88D	25500-22600	HYUNDAI
	5-86008138	ISUZU	410225.78D		19301-PNA-003	HONDA
410226.78D	19301-RAF-003	HONDA	410352.82D		0K2A-15-171	KIA
410228.82D	17570-74000	SUZUKI	410352.88D	KHE41-15-171	KIA	
	17570-740001	SUZUKI		410352.88D	0K2C0-15-171A	KIA
410229.82D	17600-83810	SUZUKI	410389.103D ▲	271 200 01 15	MERCEDES-BENZ	
	17600-83811	SUZUKI		271 200 02 15	MERCEDES-BENZ	
	17600-83820	SUZUKI		271 200 03 15	MERCEDES-BENZ	
	17600-83821	SUZUKI	410475.87D	032 121 110 L	AUDI	
	17600-83822	SUZUKI		032 121 110 L	SEAT	
	17600-83823	SUZUKI		032 121 110 L	SKODA	
	17600-85830	SUZUKI		032 121 110 L	VOLKSWAGEN	
	17600-85831	SUZUKI		032 121 121 G	AUDI	
	17670-73000	SUZUKI		032 121 121 G	SEAT	
	17670-73020	SUZUKI		032 121 121 G	SKODA	
	17670-73021	SUZUKI		032 121 121 G	VOLKSWAGEN	
	17670-83000	SUZUKI		032 121 121 K	AUDI	
	17670-83001	SUZUKI		032 121 121 K	SEAT	
	17670-83010	SUZUKI	032 121 121 K	SKODA		
	17670-83011	SUZUKI	032 121 121 K	VOLKSWAGEN		
	410230.78D	17670-63J00	SUZUKI	410488.88D	21200-BX000	NISSAN
		17670-65D00	SUZUKI		002 203 39 75	MERCEDES-BENZ
17670-77E00		SUZUKI	003 203 29 75		MERCEDES-BENZ	
17670-85C00		SUZUKI	003 203 32 75		MERCEDES-BENZ	
7174 2133		FIAT	003 203 74 75		MERCEDES-BENZ	
410231.82D	21200-AA071	SUBARU	003 203 79 75		MERCEDES-BENZ	
	21200-AA072	SUBARU	004 203 84 75		MERCEDES-BENZ	
	21210-AA030	SUBARU	005 203 28 75		MERCEDES-BENZ	
410262.91D	11 53 7 791 072	BMW	4105.75D		474 9724	IVECO
	90916-03093	TOYOTA			003 203 91 75	MERCEDES-BENZ
	90916-03123	TOYOTA			003 203 92 75	MERCEDES-BENZ
410263.91D	5278 144 AA	CHRYSLER			004 203 85 75	MERCEDES-BENZ
	11 53 1 485 847	BMW			005 203 27 75	MERCEDES-BENZ
	11 53 1 501 173	BMW	4105.83D	002 203 32 75	MERCEDES-BENZ	
	11 53 7 596 787	BMW		002 203 45 75	MERCEDES-BENZ	
4693 117 AA	CHRYSLER	002 203 47 75		MERCEDES-BENZ		
410289.81D	50 425 8346	IVECO		002 203 49 75	MERCEDES-BENZ	
	50 432 0545	IVECO		002 203 56 75	MERCEDES-BENZ	
4103.82D	90916-03046	TOYOTA		002 203 59 75	MERCEDES-BENZ	
	90916-03046-000	DAIHATSU		002 203 79 75	MERCEDES-BENZ	
	90916-03065	TOYOTA		002 203 90 75	MERCEDES-BENZ	
	90916-03069	TOYOTA		003 203 14 75	MERCEDES-BENZ	
	J 90 916 030 46	VOLKSWAGEN		003 203 28 75	MERCEDES-BENZ	
			003 203 31 75	MERCEDES-BENZ		
		003 203 31 75	MERCEDES-BENZ			
		003 203 73 75	MERCEDES-BENZ			
		003 203 78 75	MERCEDES-BENZ			
		004 203 83 75	MERCEDES-BENZ			

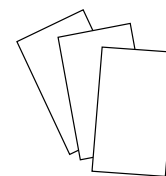

Wahler-ref.	Manufacturer's Ref.	Manufacturer	Wahler-ref.	Manufacturer's Ref.	Manufacturer
	005 203 26 75	MERCEDES-BENZ		03L 121 113 B	SKODA
	373 203 70 75	MERCEDES-BENZ		03L 121 113 B	VOLKSWAGEN
	83 129 996 050	EVOBUS			
<b>410511.88D</b>	4679 0294	FIAT	<b>410538.89D</b>	11060-00QAF	NISSAN
	4679 0294	LANCIA		17690-67JG0	SUZUKI
	6081 6681	ALFA ROMEO		82 00 112 054	RENAULT
<b>410512.88D</b>	4654 6375	FIAT	<b>410588.88D</b>	17690-84E50-000	SUZUKI
	4654 6375	LANCIA		47 08 757	OPEL
	6081 5681	ALFA ROMEO		55 182 499	GM
<b>410513.88D</b>	4652 0785	FIAT		55 182 499	VAUXHALL
	4652 0785	LANCIA		5519 9402	FIAT
	779 4218	FIAT		63 38 022	OPEL
	779 4218	LANCIA		93 177 343	GM
<b>410514.88D</b>	6065 3946	FIAT	<b>410589.88D</b>	93 177 343	VAUXHALL
	6081 4382	FIAT		93 19 3581	GM
<b>410515.88D</b>	4641 7962	FIAT	<b>410590.88D</b>	4678 5392	FIAT
<b>410516.88D</b>	779 1178	FIAT		6066 3619	ALFA ROMEO
<b>410517.83D</b>	11061-00QAB	NISSAN	<b>410591.88D</b>	4675 8586	FIAT
	11061-00QAC	NISSAN	<b>410608.86D</b>	50 409 6443 Kit	IVECO
	44 08 928	OPEL	<b>410692.71D</b>	592 1206	FIAT
	44 32 983	OPEL	<b>410705.89D</b>	1336 Z0	CITROËN
	82 00 074 349	RENAULT		1336 Z0	PEUGEOT
	82 00 674 369	RENAULT		96 472 659 80	PEUGEOT
	91 160 168	GM	<b>410758.83D</b>	50 10 295 225 2x Kit	RENAULT
	93 198 017	GM	<b>410763.82D</b>	9849 8322 Kit	IVECO
<b>410517.89D</b>	11060-AW300	NISSAN	<b>410765.90D ▲</b>	31293556	VOLVO
	11061-00QAD	NISSAN	<b>410766.103D0 ▲</b>	11 53 7 601 158	BMW
	44 04 305	OPEL	<b>410792.95D</b>	11 53 1 247 125	BMW
	82 00 074 346	RENAULT		11 53 1 432 881	BMW
	82 00 674 368	RENAULT		11 53 1 739 755	BMW
	9 112 305	GM	<b>410793.95D</b>	11 51 7 500 597	BMW
<b>410518.89D</b>	77 00 112 491	RENAULT	<b>410806.88D</b>	PEL 000170	ROVER
	77 01 474 248	RENAULT	<b>410808.88D</b>	GTS 301	ROVER
<b>410520.92D ▲</b>	708 3256	FIAT		PEL 10016	ROVER
	93 275 736	GM	<b>410828.82D</b>	50 00 684 865 Kit	RENAULT
	93235636	BUICK	<b>410828.82D0</b>	50 00 684 865	RENAULT
<b>410530.89D</b>	77 00 109 641	RENAULT	<b>410828.86D</b>	50 00 691 267 Kit	RENAULT
	77 01 474 249	RENAULT	<b>410828.86D0</b>	50 00 691 267	RENAULT
<b>410536.92D</b>	03L 121 114 B	AUDI			
	03L 121 114 B	SEAT			
	03L 121 114 B	SKODA			
	03L 121 114 B	VOLKSWAGEN			
<b>410537.92D</b>	03L 121 113 B	AUDI			
	03L 121 113 B	SEAT			

## Cross References

Wahler-ref.	Manufacturer's Ref.	Manufacturer	Wahler-ref.	Manufacturer's Ref.	Manufacturer
410845.87D	03L 121 111 AE	AUDI	411040.83D	11060-00QAJ	NISSAN
	03L 121 111 AE	SEAT		82 00 400 553	RENAULT
	03L 121 111 AE	SKODA		82 00 558 751	RENAULT
	03L 121 111 AE	VOLKSWAGEN			
410845.92D	03L 121 111 R	AUDI	411042.89D	82 00 267 349	RENAULT
	03L 121 111 R	SEAT		82 00 558 766	RENAULT
	03L 121 111 R	SKODA	411043.89D	11060-BN700	NISSAN
	03L 121 111 R	VOLKSWAGEN		11061-00Q0E	NISSAN
	03L 121 111 S	AUDI		11061-00QAG	NISSAN
	03L 121 111 S	SEAT		11061-00QAL	NISSAN
	03L 121 111 S	SKODA		17690 84A00	SUZUKI
	03L 121 111 S	VOLKSWAGEN		17690-84A10	SUZUKI
410864.71D0	81.06401.0019	MAN	17690-84A11	SUZUKI	
	81.06401.0042	MAN	82 00 039 885	RENAULT	
410864.79D0	81.06401.0037	MAN	82 00 171 021	RENAULT	
	81.06401.0046	MAN	82 00 244 402	RENAULT	
410864.83D0	81.06401.0038	MAN	82 00 374 994	DACIA	
	81.06401.0045	MAN	82 00 374 994	RENAULT	
	9011 0080	DEUTZ-FAHR	82 00 558 783	DACIA	
			82 00 558 783	RENAULT	
410871.80D ▲	0489 2642 AC	CHRYSLER	82 00 954 285	RENAULT	
	5521 5006	ALFA ROMEO	411045.82D	50 10 284 184	RENAULT
	5521 5006	FIAT		657 GC 324 A-P80	MACK
410937.82D ▲	50 438 7382	IVECO	411133.80D	129 3885 / F75-85-95	DAF
				129 3885 / F75-85-95	PACCAR
410956.83D	777 3790	FIAT	411135.83D	168 4900 / CF 75	DAF
410989.80D	032 121 110 C	VOLKSWAGEN		168 4900 / CF 75	PACCAR
410989.87D	032 121 110 B	SEAT	411135.87D	166 1375 / CF 75	DAF
	032 121 110 B	SKODA		166 1375 / CF 75	PACCAR
	032 121 110 B	VOLKSWAGEN	411186.87D	06D 121 111 G	AUDI
	032 121 110 J	SEAT		06D 121 111 G	SEAT
	032 121 110 J	SKODA		06D 121 111 G	SKODA
	032 121 110 J	VOLKSWAGEN		06D 121 111 G	VOLKSWAGEN
410994.88D	4680 4764	FIAT	411187.87D	06F 121 111 F	AUDI
411004.80D	1 423 451	SCANIA		06F 121 111 F	SEAT
	1 799 757	SCANIA		06F 121 111 F	SKODA
	1 800 909	SCANIA		06F 121 111 F	VOLKSWAGEN
	1 849 060	SCANIA			
411039.83D	11061-00Q0D	NISSAN	411193.82D	12 61 5097	SAAB
	11061-00QAM	NISSAN		12 615 097	GM
	17690-84A50-000	SUZUKI		12 615 097	VAUXHALL
	82 00 244 023	RENAULT		12 62 2410	SAAB
	82 00 400 554	DACIA		12 622 410	GM
	82 00 400 554	RENAULT		12 622 410	VAUXHALL
	82 00 558 758	DACIA		13 38 007	OPEL
	82 00 558 758	RENAULT		13 38 008	OPEL
	82 00 954 288	DACIA		13 38 034	OPEL
	82 00 954 288	RENAULT		13 38 427	OPEL
				21 018 811	GM

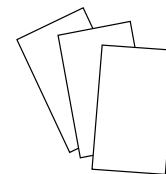

Wahler-ref.	Manufacturer's Ref.	Manufacturer	Wahler-ref.	Manufacturer's Ref.	Manufacturer	
411241.82D	21 018 811	VAUXHALL	411477.89D ▲	93 198 576	VAUXHALL	
	5177 0698	ALFA ROMEO		93 198 646	GM	
	7350 2809	FIAT		93 198 646	VAUXHALL	
	90 53 7453	SAAB				
	90 53 7811	SAAB		11 06 023 09R	RENAULT	
	90 537 453	GM		17690-84A51	SUZUKI	
	90 537 453	VAUXHALL		82 00 248 531	RENAULT	
	90 537 605	GM		82 00 558 779	RENAULT	
	90 537 605	VAUXHALL				
	90 537 811	GM		411481.89D ▲	82 00 954 289	RENAULT
	90 537 811	VAUXHALL				
411442.83D ▲	21200-ED000	NISSAN	4115.92D	13 38 046	OPEL	
	21200-ED00A	NISSAN	13 38 046	VAUXHALL		
	77 01 068 770	RENAULT	90 009 956	GM		
			90 009 956	VAUXHALL		
411475.89D ▲	11 06 030 26R	RENAULT	90 156 558	GM		
	11 06 055 36R	RENAULT				
	11060-00Q0K	NISSAN	411545.82D ▲	90916-03079	LEXUS	
	11060-00Q0S	NISSAN	90916-03079	TOYOTA		
	82 00 954 328	RENAULT	90916-03081	LEXUS		
	11060-00Q0C	NISSAN	90916-03081	TOYOTA		
	11060-00Q0E	NISSAN				
	11060-00QAL	NISSAN	411573.105D ▲	11 53 1 436 042	BMW	
	82 00 380 898	RENAULT	11 53 1 437 085	BMW		
	82 00 656 419	RENAULT				
	82 00 656 420	RENAULT	411574.102D ▲	11 53 7 552 403	BMW	
82 00 699 392	RENAULT					
82 00 703 139	RENAULT	411576.87D ▲	166 203 00 75	MERCEDES-BENZ		
82 00 801 570	RENAULT	166 203 01 75	MERCEDES-BENZ			
82 00 801 571	RENAULT	166 203 02 75	MERCEDES-BENZ			
82 00 907 229	RENAULT					
82 00 907 234	RENAULT	411577.80D ▲	266 203 02 75	MERCEDES-BENZ		
		266 203 04 75	MERCEDES-BENZ			
		266 203 06 75	MERCEDES-BENZ			
411476.83D ▲	11061-00Q0A	NISSAN	411578.92D ▲	1338 001	OPEL	
	11061-00Q0B	NISSAN	1338 098	OPEL		
	11061-00Q0G	NISSAN	24 456 401	GM		
	11061-00Q0K	NISSAN	24 456 401	VAUXHALL		
	11061-00Q0L	NISSAN	6338 005	OPEL		
	11061-00Q1B	NISSAN	6338 035	OPEL		
	44 33 121	OPEL	640972	SAAB		
	44 34 144	OPEL	90 536 262	GM		
	44 34 190	OPEL	90 536 262	VAUXHALL		
	44 49 134	OPEL	90 536 501	GM		
	44 49 506	OPEL	90 536 501	VAUXHALL		
	82 00 403 437	RENAULT	93 181 245	GM		
	82 00 703 140	RENAULT	93 181 245	VAUXHALL		
	82 00 801 567	RENAULT				
	82 00 907 239	RENAULT	411579.92D ▲	1338 004	OPEL	
	82 00 907 243	RENAULT	9158251	GM		
	93 198 035	GM				
	93 198 035	VAUXHALL	4116.87D1	069 121 113	AUDI	
	93 198 289	GM	069 121 113	VOLKSWAGEN		
	93 198 289	VAUXHALL	069 121 113 A	VOLKSWAGEN		
	93 198 317	GM	272 246	VOLVO		
	93 198 317	VAUXHALL	3 273 728	VOLVO		
	93 198 576	GM				

## Cross References

Wahler-ref.	Manufacturer's Ref.	Manufacturer	Wahler-ref.	Manufacturer's Ref.	Manufacturer
4117.80D	002 203 75 75	MERCEDES-BENZ	4147.80D	90 264 080	VAUXHALL
	002 203 80 75	MERCEDES-BENZ		90 354 822	DAEWOO
	615 200 13 15	MERCEDES-BENZ			
	616 200 04 15	MERCEDES-BENZ		1 612 191	FORD
411715.84D ▲				1337 64	PEUGEOT
	21200-AA140	SUBARU		1337 68	PEUGEOT
	21200-AA160	SUBARU		1338 20	PEUGEOT
	21200-AA220	SUBARU		1338 25	PEUGEOT
	21200-AA230	SUBARU		6 182 480	FORD
	21210-AA140	SUBARU		77 00 665 226	RENAULT
21210-AA160	SUBARU	77 00 697 157		RENAULT	
411716.88D ▲				77 00 858 087	RENAULT
	21200-AA150	SUBARU	77 00 862 200	RENAULT	
	21200-AA200	SUBARU	93 501 145	CITROËN	
	21210-AA120	SUBARU	93 501 386	CITROËN	
411743.82D ▲	21210-AA150	SUBARU	96 090 230 80	PEUGEOT	
	21200-AA170	SUBARU	96 159 513	CITROËN	
	21210-AA080	SUBARU	GTS 303	LANDROVER	
4122.87D			T 069 7157	CHRYSLER	
	1337 34	PEUGEOT	T 069 7157	JEEP	
	273 480	VOLVO			
	77 00 657 955	RENAULT	51.06402.0042	MAN	
	77 00 703 136	RENAULT	51.06402.0052	MAN	
	77 00 710 657	RENAULT	51.06402.0057	MAN	
	77 01 349 173	RENAULT	51.06402.0062	MAN	
	77 01 349 415	RENAULT	51.06402.0065	MAN	
	79 102 461 13	PEUGEOT	51.06402.0068	MAN	
4123.70					
	076 121 113 A	VOLKSWAGEN	4150.71D50		
			51.06402.0034	MAN	
			51.06402.0043	MAN	
			51.06402.0044	MAN	
			51.06402.0049	MAN	
4123.80D			51.06402.0050	MAN	
	005 203 29 75	MERCEDES-BENZ	51.06402.0051	MAN	
	075 121 113 D	AUDI	51.06402.0053	MAN	
	075 121 113 D	SEAT	51.06402.0056	MAN	
	075 121 113 D	VOLKSWAGEN	51.06402.0061	MAN	
	1 018 799	FORD	51.06402.0064	MAN	
4126.88	1 032 249	FORD	51.06402.0067	MAN	
			51.06402.0069	MAN	
	90048-33029-000	DAIHATSU			
4137.80D	90916-03043	TOYOTA	4150.83D50		
	90916-03062	TOYOTA	51.06402.0058	MAN	
			51.06402.0060	MAN	
4144.82D			51.06402.0063	MAN	
	004 203 39 75	MERCEDES-BENZ	51.06402.0066	MAN	
	004 203 40 75	MERCEDES-BENZ			
4144.92D	116 200 03 15	MERCEDES-BENZ	4151.76D		
			44 00 106	OPEL	
	13 38 059	OPEL	482 6602	FIAT	
	13 38 062	OPEL	50 00 816 924	RENAULT	
4144.92D	90 410 665	GM	9 108 106	GM	
	90 443 473	GM	9 108 106	VAUXHALL	
	13 38 049	OPEL	4151.79D		
	13 38 049	VAUXHALL	730 3174	FIAT	
4144.92D	13 38 054	OPEL	730 3615	FIAT	
	90 232 012	GM	730 3615	IVECO	
			4152.79D		
			471 6264	IVECO	

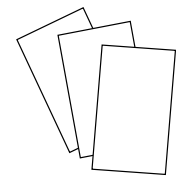

Wahler-ref.	Manufacturer's Ref.	Manufacturer	Wahler-ref.	Manufacturer's Ref.	Manufacturer
	480 7492	IVECO		9842 4854	IVECO
	483 1783	IVECO		9843 3497	IVECO
<b>4154.82D</b>	75 17 345	SAAB	<b>4166.79D</b>	480 4321	IVECO
	88 17 538	SAAB		9843 2310	IVECO
				9846 7516	IVECO
<b>4154.88D</b>	30 57 7561	SAAB	<b>4168.92D</b>	13 38 060	OPEL
	88 17 298	SAAB		13 38 060	VAUXHALL
	88 22 025	SAAB		90 352 677	GM
	91 66 687	SAAB	<b>4174.79D</b>	45 00 823	OPEL
	91 94 101	SAAB		477 0246	IVECO
	91 94 242	SAAB		482 3211	IVECO
<b>4155.87D</b>	025 121 113 D	AUDI		483 7166	IVECO
	025 121 113 D	VOLKSWAGEN		77 01 042 512	RENAULT
	025 121 113 E	AUDI		809 6735	IVECO
	025 121 113 E	VOLKSWAGEN		9 161 123	GM
	025 121 113 F	AUDI		91 61 123	VAUXHALL
	025 121 113 F	VOLKSWAGEN		9846 3637	FIAT
				9846 3637	IVECO
<b>4158.80D</b>	04778 975	CHRYSLER	<b>4174.82D</b>	1338 90	CITROËN
	13 38 466	OPEL		1338 90	PEUGEOT
	13 38 466	VAUXHALL		5 0032 9622	FIAT
	3 901 2004 F	VM		50 032 9622	IVECO
	4778 975	CHRYSLER	<b>4175.92D</b>	13 38 067	OPEL
	7 072 643	FORD		13 38 067	VAUXHALL
	91 153 670	GM		13 38 084	OPEL
	91 153 670	VAUXHALL		13 38 084	VAUXHALL
	GTS 287	ROVER		24 420 652	GM
	PEL 10009 EVA	ROVER		45 03 017	SAAB
	RTC 6673	LANDROVER		46 23 815	SAAB
				90 410 897	GM
<b>4160.83D</b>	6051 6212	ALFA ROMEO		90 502 201	GM
			<b>4176.80D</b>	003 203 98 75	MERCEDES-BENZ
<b>4161.83</b>	928.106.129.06	PORSCHE		601 200 01 15	MERCEDES-BENZ
	928.106.129.16	PORSCHE		602 200 00 15	MERCEDES-BENZ
	928.106.129.17	PORSCHE		603 200 00 15	MERCEDES-BENZ
				606 203 01 75	MERCEDES-BENZ
<b>4162.79D</b>	6131 6592	IVECO	<b>4176.85D</b>	004 203 09 75	MERCEDES-BENZ
	6131 8373	IVECO		0820117806	MULTICAR
				601 200 00 15	MERCEDES-BENZ
<b>4163.74D</b>	9849 2868	IVECO		606 203 02 75	CHEVROLET
	9849 2873	IVECO		606 203 02 75	DAEWOO
				606 203 02 75	MERCEDES-BENZ
<b>4163.79D</b>	9842 0718	IVECO		606 203 05 75	MERCEDES-BENZ
	9846 7517	IVECO	<b>4177.92D</b>	13 38 068	OPEL
				13 38 068	VAUXHALL
<b>4164.92D</b>	13 38 050	OPEL		90 411 948	CHEVROLET
	13 38 057	OPEL		90 411 948	DAEWOO
	13 38 057	VAUXHALL		90 411 948	GM
	13 38 063	OPEL		90 411 948	VAUXHALL
	13 38 063	VAUXHALL			
	90 220 435	GM			
	90 354 822	GM			
	90 443 472	GM			
<b>4165.79D</b>	473 8169	IVECO			

## Cross References

Wahler-ref.	Manufacturer's Ref.	Manufacturer	Wahler-ref.	Manufacturer's Ref.	Manufacturer
4177.92D	92 063 300	GM	4223.75D	1 431 979	SCANIA
	92 063 300	HOLDEN			
4178.92D	13 38 073	OPEL	4223.83D	1 358 995	SCANIA
	13 38 073	VAUXHALL		1 404 924	SCANIA
	90 412 901	GM		1 423 450	SCANIA
4180.82D	13 38 069	OPEL	4224.75D	1 458 198	SCANIA
	13 38 069	VAUXHALL			
	90 486 128	GM	4224.80D	1 347 594	SCANIA
	92 061 279	DAEWOO		1 404 925	SCANIA
4183.82D	13 38 080	OPEL	4231.80D	11 53 1 251 041	BMW
	90 501 699	GM			11 53 1 254 065
4183.92D	13 38 079	OPEL	4232.71	11 53 1 265 086	BMW
	13 38 079	VAUXHALL			
	90 501 081	GM	4232.80D	11 53 1 264 668	BMW
4188.92D	13 38 087	OPEL		11 53 1 265 085	BMW
	90 529 846	GM	4233.84D	003 203 82 75	MERCEDES-BENZ
	90 529 846	VAUXHALL		116 200 02 15	MERCEDES-BENZ
4189.87D	48 11 586	OPEL	4235.71D	11 53 1 466 174	BMW
	92 062 728	CHEVROLET			
	92 062 728	DAEWOO	4235.80D	11 53 1 710 953	BMW
	92 067 408	CHEVROLET		11 53 1 713 040	BMW
	92 067 408	DAEWOO	4236.88D	11 53 1 721 002	BMW
4193.92D	47 72 190	SAAB		11 53 1 721 003	BMW
	9 543 786	GM		11 53 7 511 580	BMW
4194.92D	13 38 478	OPEL	4236.92D	11 53 1 733 803	BMW
	92 063 300	GM		11 53 7 511 083	BMW
4198.92D	13 38 100	OPEL	4237.80D	11 53 1 727 145	BMW
	90 572 899	GM		11 53 2 243 126	BMW
	90 572 899	VAUXHALL		11 53 2 244 151	BMW
				11 53 2 246 199	BMW
4201.92D	13 38 009	OPEL		13 38 076	OPEL
	13 38 097	OPEL		13 38 076	VAUXHALL
	24 435 781	GM		90 509 110	GM
	24 435 781	VAUXHALL		90 509 110	VAUXHALL
	90 573 926	GM	4237.88D	11 53 2 246 825	BMW
	90 573 926	VAUXHALL			
4206.90D	272 335	VOLVO	4238.92D	11 53 1 712 043	BMW
	9 125 406	VOLVO		11 53 1 743 528	BMW
4207.92D	13 38 002	OPEL		11 53 1 743 542	BMW
	9 128 786	GM	4242.92D	13 38 003	OPEL
	91 28 786	VAUXHALL		9 129 907	GM
4208.92D	13 38 331	OPEL		91 29 907	VAUXHALL
	90 573 326	GM	4246.80D	4652 5581	FIAT
	90 573 326	VAUXHALL	4247.80D	4646 6123	FIAT



Wahler-ref.	Manufacturer's Ref.	Manufacturer	Wahler-ref.	Manufacturer's Ref.	Manufacturer	
4249.83D	996.106.013.54	PORSCHE	4256.92D50	6 058 444	FORD	
	996.106.013.55	PORSCHE		4264.84D	030 121 113	VOLKSWAGEN
	996.106.013.56	PORSCHE			030 121 113 B	AUDI
	996.106.013.57	PORSCHE			030 121 113 B	SEAT
	996.106.121.53	PORSCHE			030 121 113 B	VOLKSWAGEN
	996.106.125.52	PORSCHE			4264.87D	044 121 113
4253.87D	032 121 113	SKODA	044 121 113			SEAT
	032 121 113	VOLKSWAGEN	044 121 113	SKODA		
	056 121 113	SKODA	044 121 113	VOLKSWAGEN		
	056 121 113	VOLKSWAGEN	056 121 113 D	AUDI		
	068 121 113 H	AUDI	056 121 113 D	SEAT		
	068 121 113 H	SEAT	056 121 113 D	SKODA		
	068 121 113 H	SKODA	056 121 113 D	VOLKSWAGEN		
	068 121 113 H	VOLKSWAGEN	1 002 788	FORD		
4255.82D	08 966 483	GM	1 031 881	FORD		
	13 38 024	OPEL	1 096 699	FORD		
	13 38 024	VAUXHALL	4008540	MULTICAR		
4255.87D	08 966 485	GM	69015347	HAKO		
	08 966 485	VAUXHALL	95VW 8575 AB	FORD		
	13 38 033	OPEL	95VW 8575 AC	FORD		
	13 38 033	VAUXHALL	4269.78D	19300-PE0-013	HONDA	
4255.92D	13 38 038	OPEL		19300-PE0-024	HONDA	
	13 38 038	VAUXHALL		19300-PLZ-004	HONDA	
	90 067 918	GM	4270.88D	1 001 993	FORD	
	90 067 918	VAUXHALL		1 663 819	FORD	
4256.71	056 121 113 E	VOLKSWAGEN		6 153 501	FORD	
	068 121 113 A	VOLKSWAGEN		6 588 962	FORD	
4256.80D	056 121 113 A	AUDI	6 866 389	FORD		
		VOLKSWAGEN	89FF 8575 AA	FORD		
		CATERILLAR	89TM 8575 AA	FORD		
		CATERILLAR	928M 8575 AE	FORD		
		CATERILLAR	948M 8575 AA	FORD		
		CATERILLAR	4272.90D	271 417	VOLVO	
		CATERILLAR		271 664	VOLVO	
		CATERILLAR		74 31 397 947	RENAULT	
		CATERILLAR		74 36 842 409	RENAULT	
		CATERILLAR		74 39 180 811	RENAULT	
CATERILLAR	9 180 811	VOLVO				
4256.80D60	944.106.129.05	PORSCHE	4274.82D	077 121 113 C	AUDI	
	4256.83D60	037 121 113		VOLKSWAGEN	077 121 113 C	VOLKSWAGEN
944.106.019.00		PORSCHE	4274.87D	077 121 113	AUDI	
944.106.129.05		PORSCHE		077 121 113	SKODA	
4256.87D50	0 801 587	FORD		077 121 113	VOLKSWAGEN	
	6 100 372	FORD		077 121 113 B	AUDI	
	6 106 381	FORD		077 121 113 B	SKODA	
	6 124 378	FORD		077 121 113 B	VOLKSWAGEN	
	6 176 366	FORD		078 121 113	SKODA	
	84FF 8575 BA	FORD		078 121 113	VOLKSWAGEN	
	SE 021 032 221 B	SEAT		078 121 113 C	AUDI	



## Cross References

Wahler-ref.	Manufacturer's Ref.	Manufacturer	Wahler-ref.	Manufacturer's Ref.	Manufacturer
4274.87D	078 121 113 C	SKODA	4368.87	63 38 050	OPEL
	078 121 113 C	VOLKSWAGEN		7173 9800	FIAT
	078 121 113 F	AUDI			
	078 121 113 F	SKODA		311.00.06.0065	STEYR
	078 121 113 F	VOLKSWAGEN			
	078 121 113 J	AUDI		81.06401.6002	MAN
	078 121 113 J	SKODA			
	078 121 113 J	VOLKSWAGEN		4414.87D	111 200 17 15
4274.92D	078 121 113 G	AUDI	4428.92D	111 203 10 75	MERCEDES-BENZ
	078 121 113 H	AUDI		63 38 004	OPEL
4275.87D	00A 121 113	VOLKSWAGEN	4430.87D	070 121 114	VOLKSWAGEN
	111 200 09 15	MERCEDES-BENZ	4431.105D		
	111 203 02 75	MERCEDES-BENZ		13 38 178	OPEL
	111 203 06 75	MERCEDES-BENZ		24 405 922	GM
	111 203 08 75	MERCEDES-BENZ		24 405 922	VAUXHALL
		55 577 072		GM	
4276.87D	110 200 03 15	DAEWOO		55 577 072	VAUXHALL
	111 200 03 15	MERCEDES-BENZ		63 38 018	OPEL
	111 203 03 75	MERCEDES-BENZ		7174 4389	FIAT
4278.80D	119 200 00 15	MERCEDES-BENZ		7177 0832	FIAT
	119 203 01 75	MERCEDES-BENZ		9 698 4104	CHEVROLET
4279.87D	111 200 08 15	MERCEDES-BENZ	4433.92D	13 38 017	OPEL
	111 203 05 75	MERCEDES-BENZ		24 447 862	GM
4280.80D	603 203 04 74	MERCEDES-BENZ	4434.80D	24 447 862	VAUXHALL
	605 203 00 75	MERCEDES-BENZ			
4280.85D	603 203 04 74	MERCEDES-BENZ	4436.80D	772 1399	FIAT
	604 203 00 75	MERCEDES-BENZ		4446.83D	777 0236
4281.87D	112 200 00 15	MERCEDES-BENZ		1338 23	CITROËN
	112 203 02 75	MERCEDES-BENZ		1338 23	PEUGEOT
	5098 918 AA	CHRYSLER		17570-86CA0	SUZUKI
4297.92D				17670-66G00	SUZUKI
	13 38 015	OPEL		21215-13060-15	LADA
	24 420 728	GM		25511-29000	HYUNDAI
	24 420 728	VAUXHALL		77 00 868 274	RENAULT
4298.87D	112 200 01 15	MERCEDES-BENZ		77 01 038 494	RENAULT
	112 203 03 75	MERCEDES-BENZ		96 160 901	CITROËN
4309.92D			4447.80D	9616 0901 80	FIAT
	628 203 01 75	MERCEDES-BENZ		9616 0901 80	LANCIA
4326.97D	11 53 0 139 877	BMW		SU001-0223	TOYOTA
	11 53 1 436 823	BMW		1338 19	PEUGEOT
	11 53 1 437 040	BMW		1338 72	CITROËN
	11 53 7 509 227	BMW		1338 72	PEUGEOT
4337.105D			4447.85D	96 118 108	CITROËN
	11 53 7 510 959	BMW		96 272 785 80	PEUGEOT
4351.79	114 470	VALTRA		1338 13	PEUGEOT
	9 225 0 757 014 6	MWM		1338 71	CITROËN
4357.92D			4449.84D	1338 71	PEUGEOT
	24 435 102	SAAB		96 058 051	CITROËN
				96 272 814 80	PEUGEOT
				77 00 260 959	RENAULT

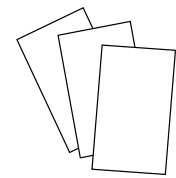

Wahler-ref.	Manufacturer's Ref.	Manufacturer	Wahler-ref.	Manufacturer's Ref.	Manufacturer
4450.83D	1338 39	CITROËN	4490.87D	642 200 02 15	MERCEDES-BENZ
	1338 39	PEUGEOT		642 200 20 15	MERCEDES-BENZ
	96 160 902 80	PEUGEOT	4508.105D	11 53 7 502 779	BMW
	9616 0902 80	FIAT		11 53 7 586 885	BMW
		11 53 7 586 885		ROLLS-ROYCE	
4450.89D	1338 26	CITROËN	4516.70D	11 53 1 731 486	BMW
	1338 26	PEUGEOT			
	96 108 092	CITROËN	4516.85D	11 53 1 710 056	BMW
	96 108 092 80	PEUGEOT		11 53 1 720 033	BMW
	96 108 093 80	PEUGEOT		11 53 1 720 306	BMW
4455.80D	022 121 113	AUDI		11 53 1 729 720	BMW
	022 121 113	VOLKSWAGEN		11 53 1 729 841	BMW
	955.106.113.00	PORSCHE	4517.87D	120 200 00 15	MERCEDES-BENZ
		120 203 02 75		MERCEDES-BENZ	
4457.82D	1 007 754	FORD	4519.95D	11 53 1 702 279	BMW
	1 211 553	FORD			
	1 303 374	FORD	4520.75	1 395 856	SCANIA
	1E05-15-171 A	MAZDA		6 052 5 010 005 0	MWM
	96MM 8575 A1A	FORD			
	96MM 8575 BD	FORD	4520.80D	0303.191.04	NEOPLAN
	96MM 8575 BE	FORD		2 832 814	SCANIA
				283 281	SCANIA
4459.92D	12 992 692	GM		2871 591 M	KOMATSU
	13 38 096	OPEL		550 275	SCANIA
	13 38 096	VAUXHALL		609E060013	STEYR
	63 38 028	OPEL	4529.70	00 24 774 033	RENAULT
	90 570 620	GM			
	90 570 620	VAUXHALL	4529.83D0	50 00 694 785	RENAULT
				4530.80	154.0943.426
4472.83D	005 203 59 75	MERCEDES-BENZ		2872 578 M	KOMATSU
4480.82D	90916-03075	TOYOTA	4572.105D	738 0513	LIEBHERR
	90916-03084	TOYOTA			
	90916-03125	TOYOTA		07Z 121 111	VOLKSWAGEN
	90916-03129	TOYOTA	4588.75/1	149 620	VALTRA
	90916-03133	TOYOTA		9 229 8 757 004 6	MWM
	90916-03136	TOYOTA	4594.90D	11 53 1 704 704	BMW
	90916-03140	TOYOTA			
	90916-03144	LEXUS		4596.83D	50 10 295 225
	90916-03144	TOYOTA	4618.70	271990009-00	BUGATTI
	90916-03145	LEXUS			
	90916-03145	TOYOTA		4618.82	27199003-00
	90916-A3001	TOYOTA	4619.75	005 203 17 75	MERCEDES-BENZ
	90916-A3002	TOYOTA		1 661 993	VOLVO
90916-A3003	TOYOTA	222730		PEGASO	
4483.82D	1 306 004	FORD		770662	PEGASO
	1 712 228	FORD	4619.80	005 203 18 75	MERCEDES-BENZ
	30 711 624	VOLVO		075 0562	DAF
	4M5G 8575 ZA	FORD			
	4M5G 8575 ZB	FORD			
4488.80D0	07K 121 113 B	VOLKSWAGEN			

## Cross References

Wahler-ref.	Manufacturer's Ref.	Manufacturer	Wahler-ref.	Manufacturer's Ref.	Manufacturer	
4619.80	11 53 1 312 288	BMW	4639.82D	17670-77E10	SUZUKI	
	11 53 1 315 063	BMW		17670-77E11	SUZUKI	
	295 024	DAF		1A51-15-171	MAZDA	
	750 562	DAF		3 396 924	FORD	
4619.82	1 544 683	VOLVO		3 599 763	FORD	
	50 01 855 520	RENAULT		3 893 570	FORD	
	8 149 182	VOLVO		3 902 514	FORD	
4619.86	005 203 19 75	MERCEDES-BENZ		4 176 181	FORD	
	1 665 694	VOLVO		4 188 498	FORD	
	50 10 447 161	RENAULT		8AGX-15-171	MAZDA	
	50 10 553 100	RENAULT	F42Z 8575 BA	FORD		
	50 409 6443	IVECO	FS05-15-171	MAZDA		
	8 149 186	VOLVO	KL01 15 171 A	FORD		
	8929878	DETROIT DIESEL	KL01-15-171	MAZDA		
	9943 1512	IVECO	KL01-15-171 A	MAZDA		
4621.80D	11 53 1 318 274	BMW	XM34 8575 AA	FORD		
			XM34 8575 AB	FORD		
4622.82D0	9849 8322	IVECO	4814.92D	06C 121 111 C	VOLKSWAGEN	
4630.87D ▲	5175583AB	JEEP		06C 121 111 D	VOLKSWAGEN	
	642 200 03 15	MERCEDES-BENZ		06C 121 111 E	VOLKSWAGEN	
4634.76	21200-77A00	NISSAN	4816.90D	3063 7217	VOLVO	
	21200-77A60	NISSAN		3065 0022	VOLVO	
	21200-77A61	NISSAN		3077 7475	VOLVO	
	21200-77A63	NISSAN		3129 3699	VOLVO	
4637.76D	MD 164541	MITSUBISHI		4817.90D	3063 7216	VOLVO
	MD 170031	MITSUBISHI			3065 0023	VOLVO
	MD 317015	MITSUBISHI	3121 9205		VOLVO	
	MD 345617	MITSUBISHI	4818.90D	3065 0469	VOLVO	
	ME 190303	MITSUBISHI		3077 7476	VOLVO	
	ME 191593	MITSUBISHI		3129 3698	VOLVO	
	ME 200262	MITSUBISHI		4820.87D	03G 121 111 A	AUDI
4637.82D	30874021	VOLVO	03G 121 111 A		SEAT	
	30875350	VOLVO	03G 121 111 A		SKODA	
	MD 158570	MITSUBISHI	03G 121 111 A		VOLKSWAGEN	
	MD 165630	MITSUBISHI	03G 121 113 A		AUDI	
	MD 175746	MITSUBISHI	03G 121 113 A		SEAT	
	MD 310106	MITSUBISHI	03G 121 113 A		SKODA	
	MD 315301	MITSUBISHI	03G 121 113 A	VOLKSWAGEN		
	MD 335170	MITSUBISHI	4821.89D	1338 21	CITROËN	
	MD 337408	MITSUBISHI		1338 21	PEUGEOT	
	MD 338234	MITSUBISHI		1338 C8	PEUGEOT	
	MD 360320	MITSUBISHI		21200-6F900	NISSAN	
	4638.76D	MD 997605		MITSUBISHI	21200-6F901	NISSAN
				96 006 231	CITROËN	
4638.82D	MD 015299	MITSUBISHI	GTS 299	ROVER		
	MD 094120	MITSUBISHI	PEL 10019 EVA	ROVER		
	MD 997224	MITSUBISHI	4825.98D	1 345 512	FORD	
	MD 997606	MITSUBISHI		1 351 716	FORD	
	ME 999295	MITSUBISHI		4M5G 6L721 GA	FORD	
		4M5G 6L721 GB		FORD		

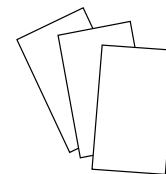

Wahler-ref.	Manufacturer's Ref.	Manufacturer	Wahler-ref.	Manufacturer's Ref.	Manufacturer					
4829.100D ▲	272 200 06 15	MERCEDES-BENZ		6 077 896	FORD					
	273 200 01 15	MERCEDES-BENZ		6 077 897	FORD					
	273 200 04 15	MERCEDES-BENZ		6 077 898	FORD					
4832.87D ▲	642 200 07 15	MERCEDES-BENZ		6 077 985	FORD					
				823 959 481 G	AUDI					
4833.100D	272 200 05 15	MERCEDES-BENZ		823 959 481 G	SEAT					
				823 959 481 G	SKODA					
				823 959 481 G	VOLKSWAGEN					
4834.100D	273 200 02 15	MERCEDES-BENZ		823 959 481 H	SKODA					
				6801 3949 AA	CHRYSLER	823 959 481 H	VOLKSWAGEN			
						823 959 481 K	SKODA			
4835.87D	272 200 00 15	MERCEDES-BENZ		823 959 481 K	VOLKSWAGEN					
				272 200 01 15	MERCEDES-BENZ	90 108 636	GM			
						272 200 04 15	MERCEDES-BENZ	90 108 636	VAUXHALL	
6010.75D	642 200 02 15	MERCEDES-BENZ		95 26 518	SAAB					
				642 200 04 15	MERCEDES-BENZ	595 1985	FIAT			
6010.88D	113 095 075	SKODA				595 1987	FIAT			
				217.87.71	STEYR	191 959 481 A	AUDI			
						84247900	INTER. HARV. IHC	191 959 481 A	SEAT	
6010.92D	115 095 070	SKODA		191 959 481 A	VOLKSWAGEN					
				547 4546	FIAT	191 959 481 C	AUDI			
						5474546	CITROËN	191 959 481 C	SEAT	
				5474546	PEUGEOT			191 959 481 C	VOLKSWAGEN	
						6 144 361	FORD	251 959 481	AUDI	
				85 47 572	SAAB			251 959 481	SEAT	
6010.95D	113 095 090	SKODA				251 959 481	VOLKSWAGEN			
				2828 6103	FIAT	321 959 481 A	AUDI			
						411 4572	FIAT	321 959 481 A	SEAT	
				423 5333	FIAT			321 959 481 A	VOLKSWAGEN	
						423 5533	FIAT	321 959 481 C	AUDI	
			424 0878	FIAT	321 959 481 C			SEAT		
					426 3597	FIAT	321 959 481 C	VOLKSWAGEN		
			823 959 481	AUDI			321 959 481 C	VOLKSWAGEN		
					823 959 481	SEAT	321 959 481 D	AUDI		
			823 959 481	VOLKSWAGEN			321 959 481 D	SEAT		
					823 959 481 A	AUDI	321 959 481 D	VOLKSWAGEN		
			823 959 481 A	SEAT			441 044 330 186	SKODA		
					823 959 481 A	VOLKSWAGEN	6U0 959 481 A	AUDI		
			823 959 481 F	AUDI			6U0 959 481 A	SEAT		
					823 959 481 F	SEAT	6U0 959 481 A	VOLKSWAGEN		
			823 959 481 F	VOLKSWAGEN			SE 021 952 600 A	SEAT		
					823 959 481 L	AUDI	191 959 481 B	AUDI		
			823 959 481 L	SEAT			191 959 481 B	SEAT		
					823 959 481 L	VOLKSWAGEN	191 959 481 B	VOLKSWAGEN		
			85 69 23	SAAB			321 959 481 B	VOLKSWAGEN		
944.606.481.00	PORSCHE	321 959 481 E			AUDI					
		6010.95D	13 41 002	OPEL	321 959 481 E	VOLKSWAGEN				
426 3997	AUTOBIANCHI				321 959 481 G	VOLKSWAGEN				
					434 0878	FIAT	811 959 481	AUDI		
6 072 016	FORD						811 959 481	VOLKSWAGEN		
					6 077 895	FORD	893 959 481	AUDI		
6016.92	595 1985						FIAT	893 959 481	VOLKSWAGEN	
		6017.95D	191 959 481 A	AUDI	811 959 481	VOLKSWAGEN				
					6020.92D	SE 021 952 600 A		SEAT	893 959 481	AUDI
									6020.95D	191 959 481 B
6024.95D	811 959 481				AUDI	811 959 481	VOLKSWAGEN			
		6024.95D	811 959 481	VOLKSWAGEN		893 959 481	AUDI			
6024.95D	893 959 481				VOLKSWAGEN	893 959 481	VOLKSWAGEN			
		6024.95D	893 959 481	VOLKSWAGEN		893 959 481	VOLKSWAGEN			

## Cross References

Wahler-ref.	Manufacturer's Ref.	Manufacturer
-------------	---------------------	--------------

<b>6031.100D</b>	13 41 011	OPEL
	13 41 011	VAUXHALL
	90 242 277	GM
	90 242 277	VAUXHALL
<b>6031.105D</b>	13 41 017	OPEL
	13 41 017	VAUXHALL
	90 277 288	GM
	90 277 288	VAUXHALL
<b>6031.88D</b>	1264 50	PEUGEOT
	13 0707 7080	FIAT
	13 41 028	OPEL
	13 41 028	VAUXHALL
	90 357 303	GM
	90 357 303	VAUXHALL
<b>6031.92D</b>	1264 32	PEUGEOT
	1264 50	PEUGEOT
	599 2746	FIAT
	6056 4101	FIAT
	6080 8223	FIAT
	774 8867	FIAT
	8242 0013	FIAT
	8243 6410	FIAT
	8246 5533	FIAT
	8247 7919	FIAT
907 0701	FIAT	
<b>6031.97D</b>	4652 0219	FIAT

# Gasket

Wahler-ref.	Gasket	Wahler-ref.	Gasket	Wahler-ref.	Gasket
100456D5	100456	3119.88D5	100601	4038.71D	104224
102543D5	102543		100607	4038.76D	104224
110156D5	110156	3119.92D3	100599	4038.81D	104224
110392D5	110392		100600	4049.80D	002085
115600D5	115600	3136.82D50	002154	4049.80D1	002479
117385D5	117385		105433	4049.87D	002085
3004.82D1	002149	3136.88D50	002154	4064.75D	002085
3004.88D1	002149		105433	4078.65D	002085
3004.92D1	002149	3141.87D	002138	4078.71D	002085
3017.87D2	003187	3142.90D	102642	4078.75D	002085
3017.87D50	002137	3143.87D	102725	4078.79D	002085
	002150	3145.79D	108476	4078.87D	002085
3017.92D2	003187	3146.90D	102642	4078.92D	002085
3017.92D50	002137	3151.87D	003062	4083.83D50	002892
	002150	3159.82D	003594		002922
3021.88D50	002153	3163.88D	104360	4088.80D	002085
	002163	3164.88	104360	4088.87D	002085
	002164	3166.89D	105317	4089.71D	003192
	002523	3167.83D	102725	4089.82D	003192
3021.92D50	002153	3169.79D	119164	4089.87D	003192
	002163	3171.82D	119081	4089.92D	003192
	002164	3174.89D	105571	4091.82D	116692
	002523	3300.80D	104361		116693
3023.87D	002160	3301.80D	104361	410007.87D	003588
3033.78D	120675	3302.80D	104361	410048.88D	109953
3033.84D	120675	3355.80D	003587	410049.88D	109944
3044.90D1	100595	3356.80D	003590	410055.87D	114270
3054.87D50	002143	3360.87D	003588		114365
	002153	3361.87D	003588	410058.84D	114419
3054.92D50	002143	3373.80D	003587	410075.79D	119164
	002153	3383.87	108485	410081.79D	119164
3091.92D	002137	3431.80D	104361	410090.88D	112151
3100.88D	102511	3457.90D	114432	410131.88D	102511
3100.92D	102511		114433	410171.87D	104738
3103.79	003602	3466.89D	105414	410174.92D	104738
3105.87D	003062	3467.85D	114595	410178.82D	114229
3109.82D	003592	3469.91D	105414	410181.82D	115702
3109.87D	003592	3470.89D50	105434	410183.82D	118938
3116.82D	120392		105435		118939
3116.89D	120392	3472.87D	002138	410183.88D	118938
3118.82D1	100596	3477.88D	115864		118939
	100597	3478.82D	115422	410201.80D	115864
	100606	3481.88D	104360	410224.78D	115423
3118.88D1	100596	3484.87D	108485	410224.82D	115423
	100597	3485.87D	108485	410228.82D	100596
	100606	3498.88D	100599	410230.78D	116903
3118.92D1	100596	3499.82D	100599	410262.91D	114731
	100597	3499.88D	100599	410263.91D	114731
	100606	4006.82D	002138	410289.81D	120389
3119.82D3	100599	4007.80D	110991	4103.82D	115422
	100600	4008.74D	003594	410348.82D	117136
3119.82D4	100605	4008.79D	003594		118913
3119.82D5	100601	4022.82D	003192	410352.82D	100599
	100607	4022.82D1	003595	410352.88D	100599
3119.88D3	100599	4022.88D	003192	410389.103D	116490
	100600	4022.92D	003192		118342
3119.88D4	100605	4033.82D	002144	410475.80D	102725
		4038.65D	104224	410475.87D	102725

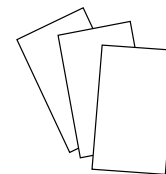

Wahler-ref.	Gasket	Wahler-ref.	Gasket	Wahler-ref.	Gasket
410488.88D	003192	4115.92D	002900	4201.92D	104892
4105.65D	002892	411545.82D	115864	4206.90D	100928
4105.71D	002892	4116.87D1	102081		101313
4105.75D	002892	4117.80D	002085	4207.92D	104892
4105.79D	002892	411715.84D	116903	4208.92D	102543
4105.83D	002892	411716.88D	116903	4223.75D	122689
410513.88D	003123	411743.82D	116903	4223.83D	122689
410514.88D	003123	4122.87D	002898	4224.75D	122690
410515.88D	003123	4123.80D	102081	4224.80D	122690
410516.88D	003123	4132.74D	002817	4231.71D	002140
410537.92D	002138	4137.71D	002085	4231.80D	002140
410590.88D	003123	4137.80D	002085	4231.84D	002140
410608.86D	118996	4144.82D	101973	4232.80D	002085
	119078	4144.92D	101973	4233.80D	002430
	119080	4147.80D	002898	4233.84D	002430
	120213	4150.71D50	002892	4235.71D	002085
	4619.86		106244	4235.75D	002085
410692.71D	119879	4150.79D50	002892	4235.80D	002085
	119880		106244	4236.88D	002085
410758.83D	120299	4150.83D50	002892	4236.92D	002085
	4596.83		106244	4237.80D	002085
410763.82D	003896	4151.76D	120392	4237.88D	002085
	120329	4151.79D	120392	4238.92D	002085
	120330	4152.79D	002817	4242.92D	102543
	4622.82D0	4154.82D	003192	4246.80D	104361
410765.90D	120222	4154.88D	003192	4247.80D	104361
410806.88D	120763	4155.87D	102081	4249.71D	106281
410808.88D	120763	4158.80D	002817	4249.83D	106281
410828.82D	121904	4160.83D	003052	4253.87D	002138
	122345	4162.79D	120392	4255.82D	003561
410828.86D	121904	4163.74D	002817	4255.87D	003561
	122345	4163.79D	102226	4255.92D	003561
410845.87D	120086	4164.92D	101973	4256.80D	002138
410845.92D	120086	4165.79D	102226	4256.80D60	000232
410871.80D	112151	4166.79D	002817		003602
	127334		102226	4256.83D60	003602
410937.82D	119081	4168.92D	101973		120392
410989.80D	124401	4174.79D	003595	4256.87D50	002138
410989.87D	124401		120392		002147
410994.88D	003123	4174.82D	003595		002148
411004.80D	122690		120392	4256.92D50	002138
411045.82D	121908	4174.88D	003595		002147
411133.80D	123872		120392		002148
	123873	4175.92D	100008	4264.84D	002138
	4619.80	4176.70D	002584	4264.87D	002138
411135.83D	123747	4176.75D	002584	4269.78D	115423
	123748	4176.80D	002584	4270.88D	102511
	411089.83D	4176.85D	002584	4272.90D	003192
411135.87D	123747	4177.92D	100007	4274.82D	102081
	123748	4178.92D	101973	4274.87D	102081
	411089.87D	4180.82D	101973	4274.92D	102081
411186.87D	120086	4183.82D	100007	4275.87D	002085
	127069	4183.92D	100007	4276.87D	002085
	127070	4188.92D	104892	4278.80D	102084
411187.87D	120086	4189.87D	100007	4279.87D	002085
	127069	4193.92D	104892	4280.80D	003650
	127070	4194.92D	100007	4280.85D	003650
4112.79D	002892	4198.92D	104892	4281.87D	003658

# Gasket

Wahler-ref.

Gasket

Wahler-ref.

Gasket

Wahler-ref.

Gasket

4297.92D 104892  
 4298.87D 003658  
 4309.92D 101642  
 4357.92D 104385  
 4414.87D 002085  
 4428.92D 104892  
 4430.87D 115028  
 4431.105D 104385  
 4433.92D 104892  
 4434.80D 104361  
 4436.80D 104361  
 4446.83D 105410  
 4447.80D 002898  
 4447.85D 002898  
 4449.84D 002898  
 4450.83D 105410  
 4450.89D 105410  
 4455.80D 102081  
 4457.82D 105686  
 106503  
 4459.92D 102322  
 4472.83D 002892  
 4480.82D 114229  
 4483.82D 106307  
 106503  
 4489.90D 108431  
 4490.87D 117217  
 4508.105D 100532  
 4516.70D 104887  
 4516.85D 104887  
 4517.87D 002085  
 4519.95D 104887  
 4520.80D 104470  
 4572.105D 120626  
 4594.90D 003562  
 4596.83D 120298  
 4621.80D 101216  
 4630.87D 117217  
 4638.76D 111209  
 4638.82D 111209  
 4814.92D 103394  
 4816.90D 114704  
 4817.90D 114704  
 4818.90D 114704  
 4820.87D 002138  
 4821.89D 109319  
 4829.100D 110657  
 4832.87D 114270  
 117217  
 4833.100D 110657  
 4834.100D 110657  
 111203  
 4835.87D 117217  
 6010.100D 002358  
 6010.70D 002358  
 6010.75D 002358  
 6010.82D 002358  
 6010.85D 002358

6010.88D 002358  
 6010.92D 002358  
 6010.95D 002358  
 6017.85D 002358  
 6017.95D 002358  
 6020.92D 002358  
 6020.95D 002358  
 6024.95D 002358  
 6031.100D 002358  
 6031.105D 002358  
 6031.88D 002358  
 6031.92D 002358  
 6031.97D 002358  
 60347D 123800  
 123801  
 6035.92D 002358  
 60364D 117385  
 6037.81D 002358  
 6037.87D 002358  
 6037.95D 002358  
 60375D 115586  
 6039.95D 002358  
 60409D 115600  
 117385  
 60415D 123800  
 60579D 126105  
 60595D 101541  
 102241  
 117943  
 60633D 115600  
 117385  
 60700D 115600  
 117385  
 60702D 115600  
 117385  
 60777D 115600D5  
 117385  
 6087.87D 002358  
 61010D 115600  
 61384D 117385  
 665104D 115600D5  
 665574D 100456  
 102543  
 110156  
 110392  
 115600  
 117385  
 710023D 103046  
 710073D 110221  
 710095D 106306  
 710327D 103386  
 710476D 123589  
 710559D 127104  
 710571D 110392  
 710572D 110392  
 710574D 115600  
 127082  
 7159D 115586

7187D 101561  
 115600  
 7188D 115599  
 7206D 101541  
 117943  
 117944  
 7211D 115599  
 7220D 117943  
 117944  
 7223D 110156  
 7234D 115618  
 115619  
 7241D 100456  
 115600  
 7256D 120620  
 7268D 111127  
 117420  
 117421  
 7271D 103995  
 115600  
 7283D 100456  
 7293D 100456  
 7294D 100456  
 115600  
 117385  
 7301D 117385  
 7327D 110156  
 115600  
 117385  
 7350D 118533  
 7353D 103046  
 7371D 110156  
 115600  
 7372D 110156  
 115600  
 117385  
 7375D 115593  
 7389D 103046  
 7396D 121743  
 121747  
 7451D 110156  
 117385  
 7496D 102543  
 110156  
 115600  
 7497D 118533  
 118534  
 7504D 110221  
 7523D 118530  
 7527D 106306  
 7529D 110392  
 7545D 108551  
 7556D 108056  
 7557D 108056  
 7574D 117948  
 126163  
 7610D 123590  
 7625D 103046



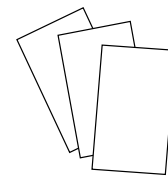

<b>Wahler-ref.</b>	<b>Gasket</b>
--------------------	---------------

<b>7631D</b>	118493 118532 118533
<b>7645D</b>	106306
<b>7649D</b>	101953 115600
<b>7650D</b>	101953 117385

## Supersession List

Wahler-ref.

Gasket

Wahler-ref.

Gasket

**003602** 120392  
**100928** 120389  
**104360** 003123  
**115600** 115600D5  
**117385** 117385D5  
**2383.75** 2391.75  
**3000.70** 3000.75  
**3004.88** 3004.88D1  
**3021.88** 3021.88D50  
**3029.72** 3029.78  
**3033.78** 3033.78D  
**3033.84** 3033.84D  
**3044.90** 3044.90D1  
**3053.72** 3053.75  
**3053.78** 3053.75  
**3054.92D** 3054.92D50  
**3118.82** 3118.82D1  
**3118.88** 3118.88D1  
**3118.92** 3118.92D1  
**3119.92** 3119.92D3  
**3347.80** 3343.80D  
**3391.92D** 4459.92D  
**4069.75/1** 4083.79  
**4083.71** 4105.71D  
**4083.71D1** 4105.71D  
**4083.79** 4105.79D  
**4083.83** 4105.83D  
**4089.87** 4089.87D  
**4089.92** 4089.92D  
**4091.82** 4091.82D  
**410044.82D** 410231.82D  
**410069.82D** 410937.82D  
**410176.82** 410176.82D0  
**410176.88** 410176.88D0  
**4103.82** 4103.82D  
**410695.105D** 411059.105D  
**4112.79D** 4150.79D50  
**4116.87D** 4116.87D1  
**4160.83** 4160.83D  
**4165.79** 4165.79D  
**4166.79** 4166.79D  
**4238.92D** 4236.92D  
**4269.78** 4269.78D  
**4340.80** 4341.80  
**4371.80** 4351.79  
**4378.80** 4341.80  
**4379.80** 4351.79  
**4417.81D** 410289.81D  
**4453.87D** 410171.87D  
**4488.80** 4488.80D0  
**4523.75** 4520.75  
**4523.80** 4520.80D  
**4546.80** 4565.80  
**4546.80** 4565.80/2  
**4547.70** 4565.70  
**4547.80** 4565.80  
**4547.80** 4565.80/2

**4565.80** 4565.80/2  
**4570.80** 4684.80/1  
**4596.83** 4596.83D  
**4622.82** 4622.82D0  
**4663.80/1** 410864.79D0  
**4665.80/1** 4684.80/1  
**4684.70/1** 410864.71D0  
**4684.80/1** 410864.79D0  
**4684.83/1** 410864.83D0  
**4689.97** 4689.97D0  
**4689.97D0** 410086.97D0  
**6035.92** 6035.92D

# Assembly dimensions

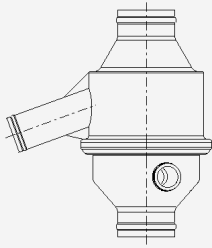

**Typ 2389**

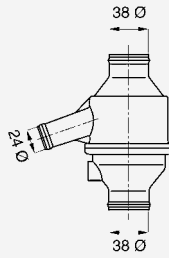

**Typ 2391  
2394**

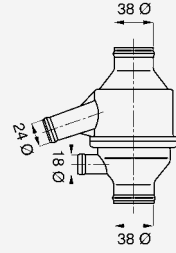

**Typ 2393**

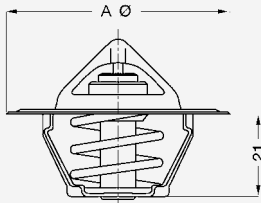

**Typ A**  
**3000** 54 mit Entlüftungskerbe  
**3021** 48  
**3044** 44  
**3136** 53,5  
**3141** 54 ohne Entlüftungskerbe  
**3167** 54 gummibeschichtete Ventilplatte

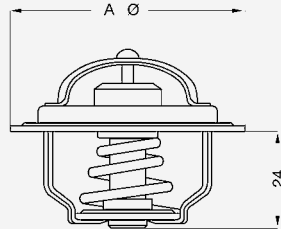

**Typ A**  
**3004** 54 mit Entlüftungsventil  
**3032** 60 mit Entlüftungsventil  
**3061** 57 mit Entlüftungsventil  
**3063** 53,5 mit Entlüftungskerbe

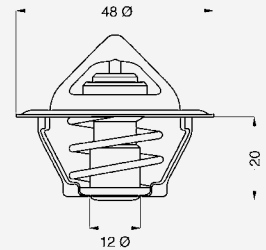

**Typ 3017  
3091** mit Entlüftungsventil und gummibeschichteter Ventilplatte  
**3082** gummibeschichtete Ventilplatte

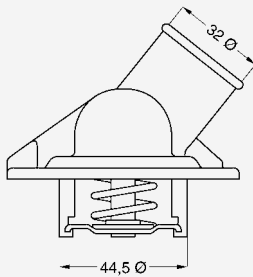

**Typ 3022**

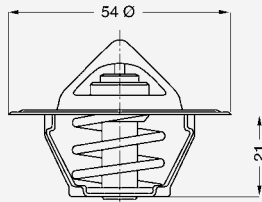

**Typ 3023** mit Entlüftungskerbe

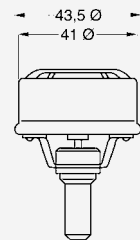

**Typ 3029**

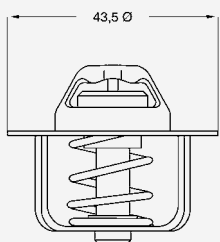

**Typ 3033**

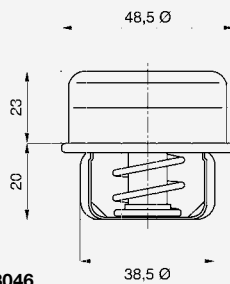

**Typ 3046**

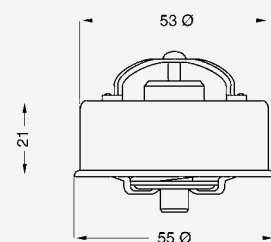

**Typ 3053**

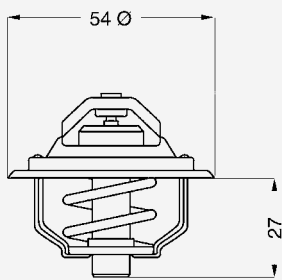
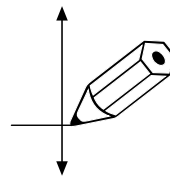

Typ 3054

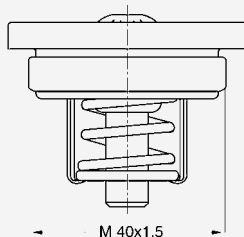

Typ 3067

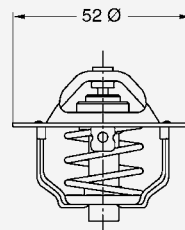

Typ 3100

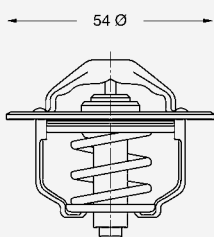

Typ 3103 mit Entlüftungsventil

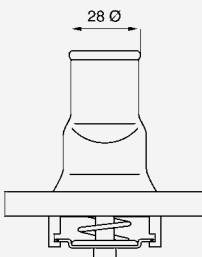

Typ 3105

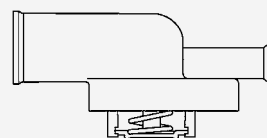

Typ 3109

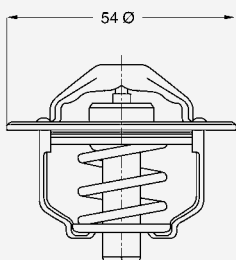

Typ 3116 mit Entlüftungsventil

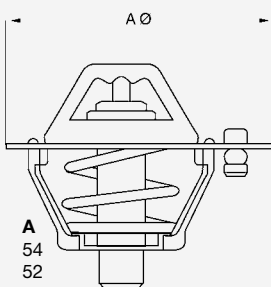

Typ	A
3118	54
3119	52
3499	52

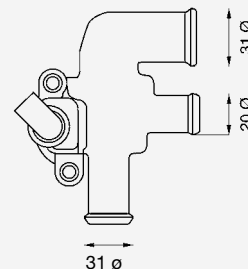

Typ 3142

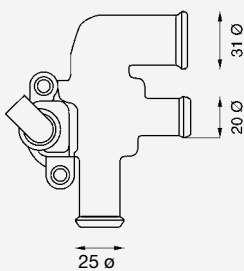

Typ 3146

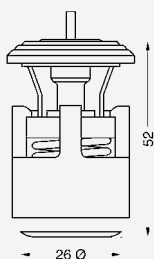

Typ 3143

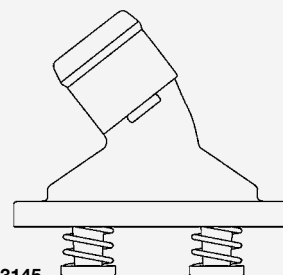

Typ 3145

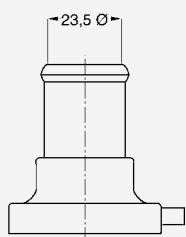

Typ 3151

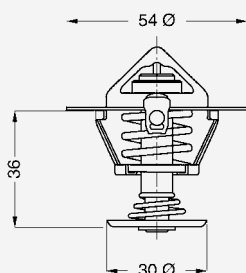

Typ 3159

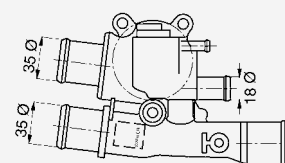

Typ 3163 mit M 12 x 1,5  
3481 mit M 12 x 1,5 / M 16 x 1,5

# Assembly dimensions

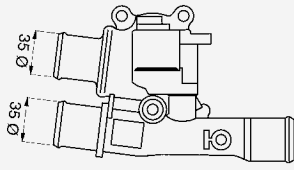

Typ 3164

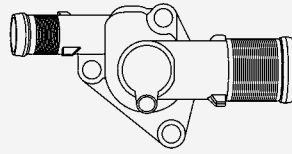

Typ 3166

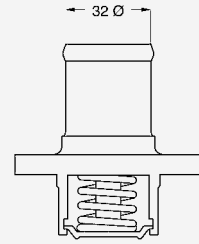

Typ 3174

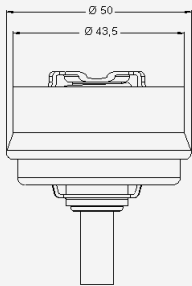

Typ 3187

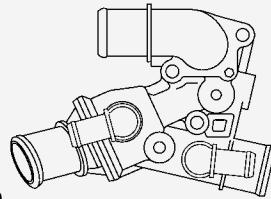

Typ  
3300  
4434 mit M22 x 1,5  
4436 mit M16 x 1,5

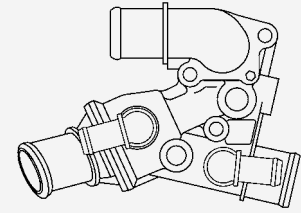

Typ  
3301 mit 2 x M16 x 1,5  
3302 mit 1 x M16 x 1,5

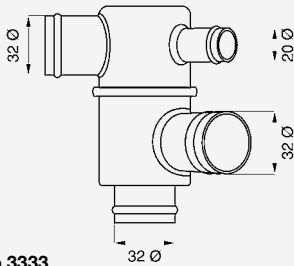

Typ 3333

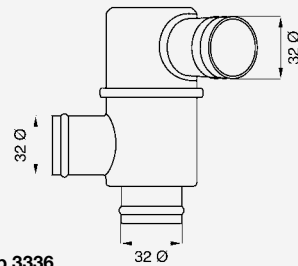

Typ 3336

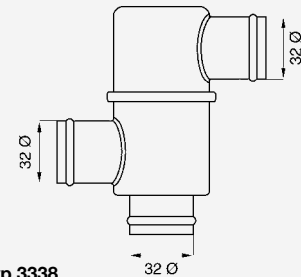

Typ 3338

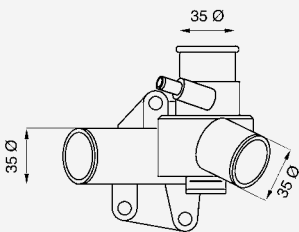

Typ  
3343 21 Ø  
3347 16,8 Ø

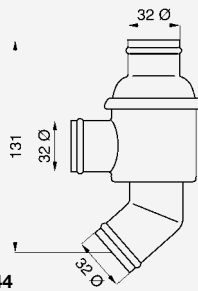

Typ 3344

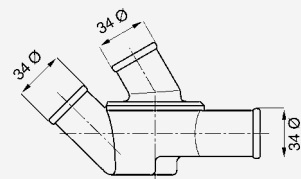

Typ 3345

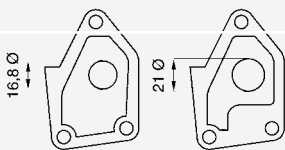

Typ  
3343 21 Ø  
3347 16,8 Ø

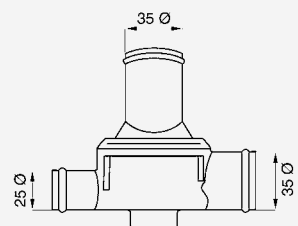

Typ 3352

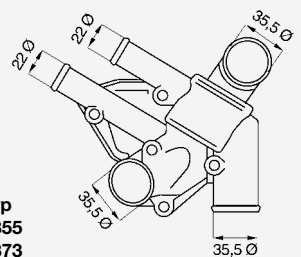

Typ  
3355  
3373  
3378

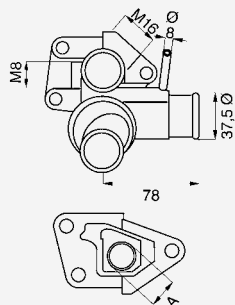
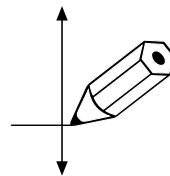

**Typ A**  
**3356** 21, mit M 16, ohne M8, mit Ø 8  
**3364** 23, ohne M 16, ohne M8, ohne Ø 8  
**3366** 21, mit M 16, mit M8, mit Ø 8

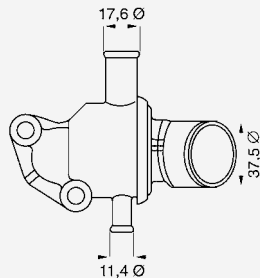

**Typ 3361**  
**3360** Stützen am Deckel um 90° gedreht

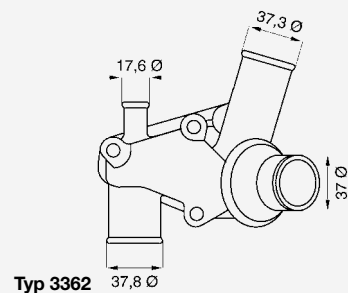

**Typ 3362**

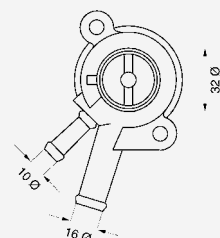

**Typ 3383** mit Ø 10, 31 mm  
**3484** mit Ø 10, 51 mm  
**3485** ohne Ø 10

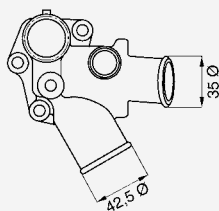

**Typ 3431**

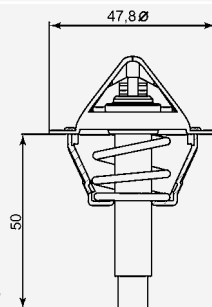

**Typ 3457**

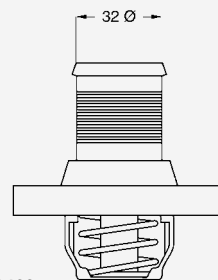

**Typ 3463**

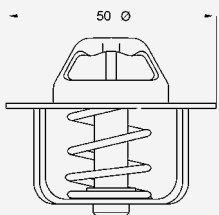

**Typ 3466**

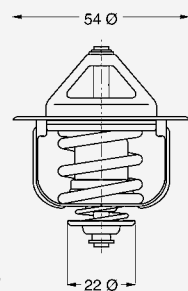

**Typ 3467**

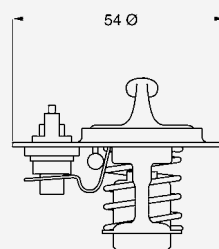

**Typ 3468**

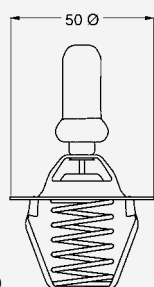

**Typ 3469**

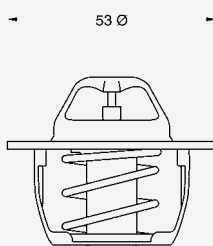

**Typ 3470**

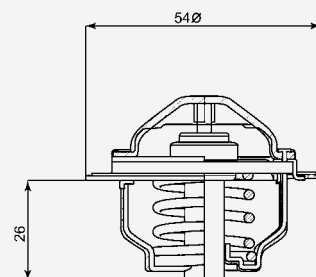

**Typ 3472**

# Assembly dimensions

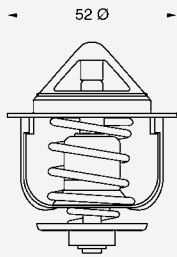

Typ 3477

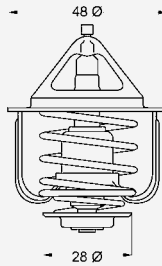

Typ 3478

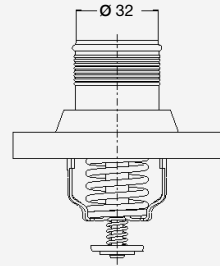

Typ 3483

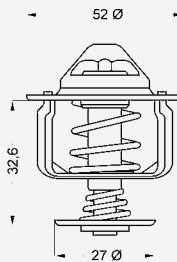

Typ 3497

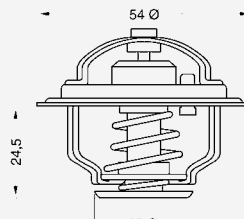

Typ  
4003 ohne Entlüftungsventil oder -kerbe  
4008 mit Entlüftungsventil  
4015 mit Entlüftungsventil

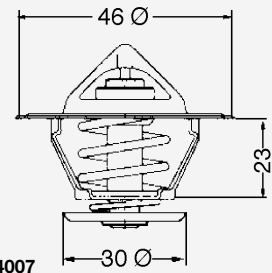

Typ 4007

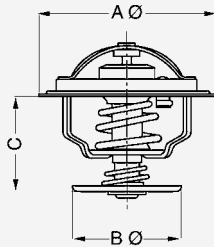

Typ	A	B	C	
4006	54	35	33	mit Entlüftungsventil
4026	54	28	30	mit Positionskerbe
4029	54	29	32	mit Entlüftungsventil
4033	56	34	33	ohne Entlüftungsventil oder -Kerbe
4154	54	29	32	mit Entlüftungsventil
4253	54	35	31	Ventilteller gummi-beschichtet
4256	54	35	31	ohne Entlüftungsventil oder -Kerbe
4272	54	35	31	mit Entlüftungsventil

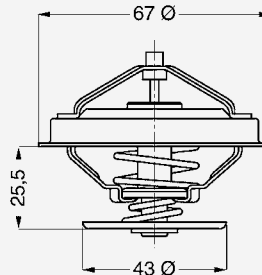

Typ	
4030	mit Entlüftungskerbe
4059	
4064	mit Entlüftungsventil kühlenseitig
4078	mit Entlüftungsventil motorseitig
4083	mit Entlüftungskerbe
4112	mit Entlüftungsventil
4122	mit Entlüftungsventil
4158	mit Entlüftungsventil

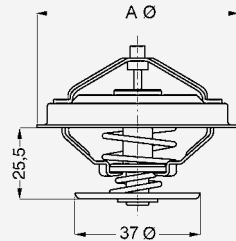

Typ	A	B	
4049	67	37	ohne Entlüftungsventil oder -kerbe
4088	67	37	ohne Entlüftungsventil oder -kerbe
4132	75	43	mit Entlüftungskerbe
4116	67	37	Ventilteller gummi-beschichtet
4117	67	37	mit Entlüftungskerbe

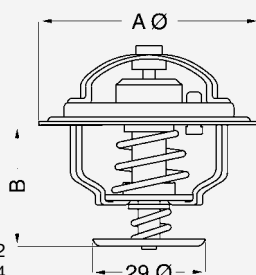

Typ	A	B
4022	54	32
4126	52	34
4154	54	32

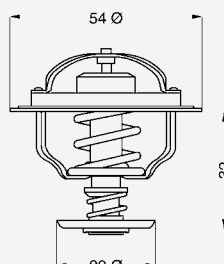

Typ 4038

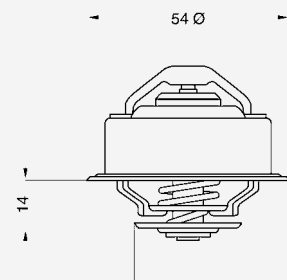

Typ 4089

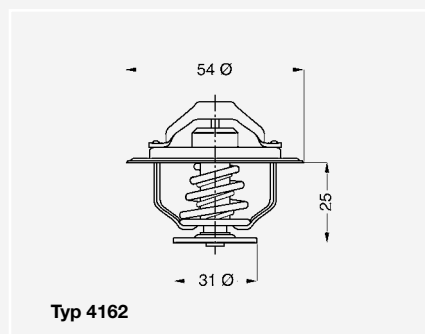
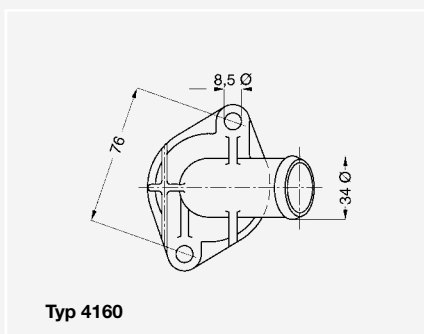
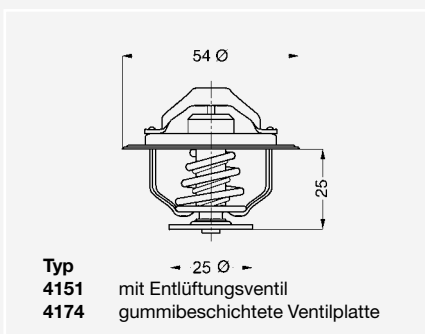
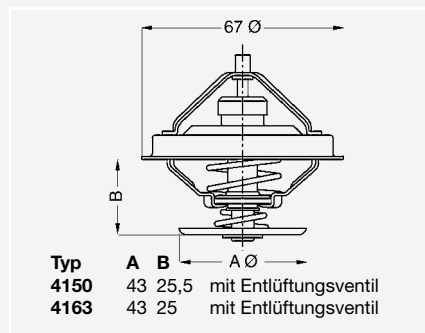
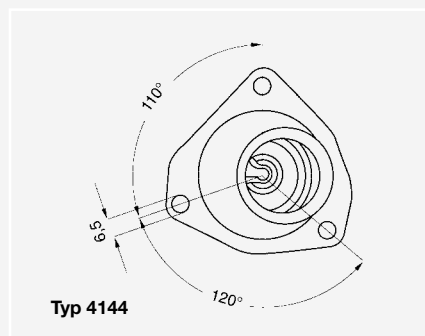
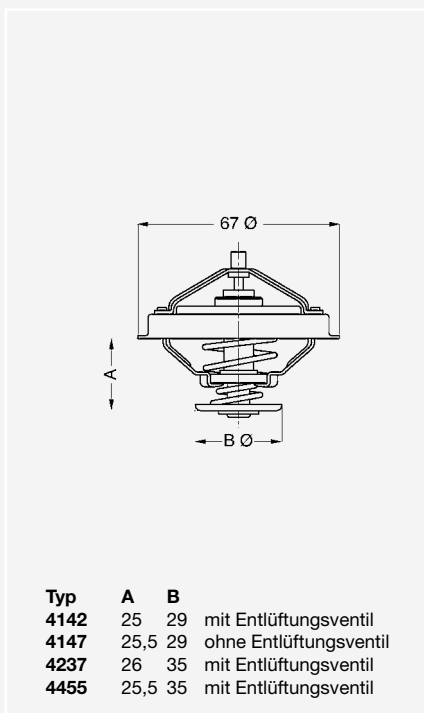
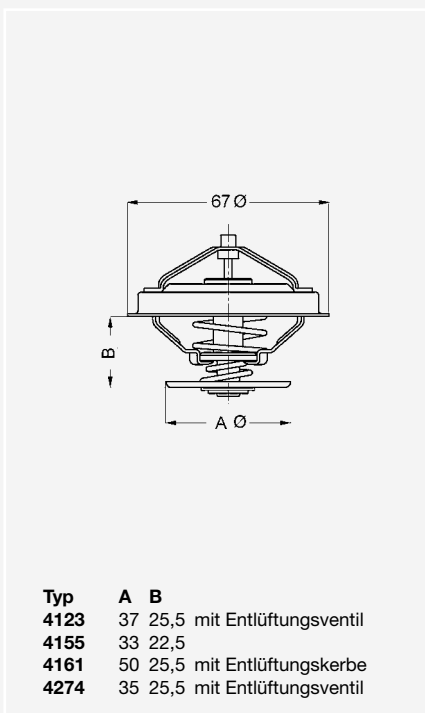
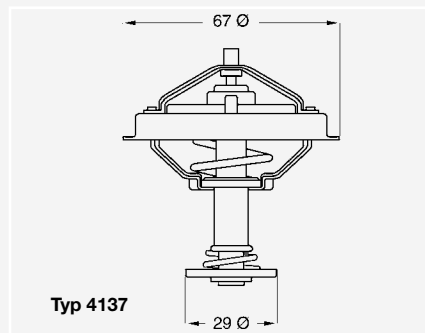
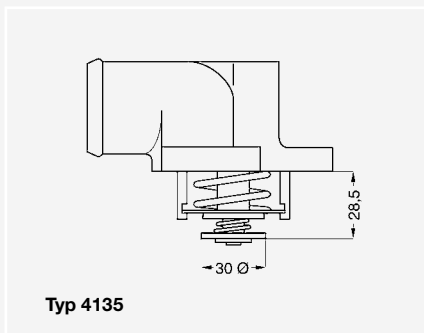
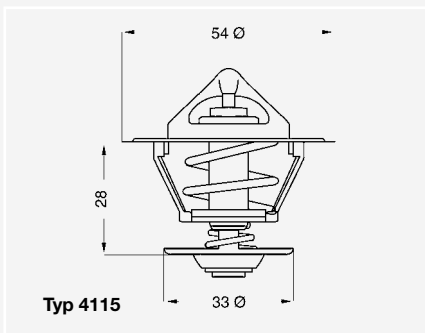
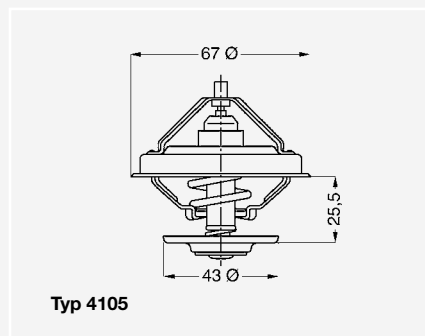
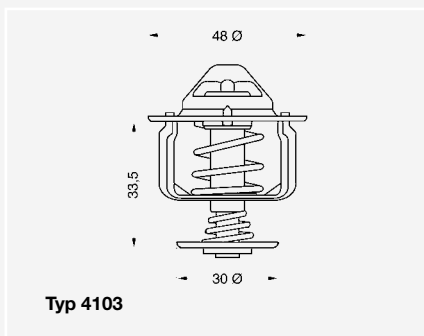
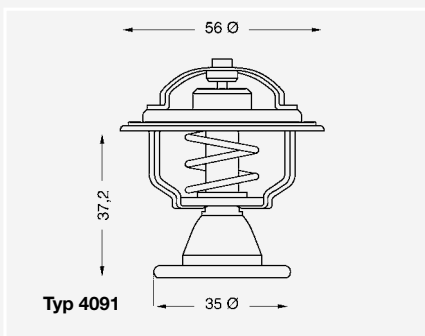
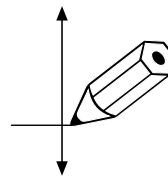



# Assembly dimensions

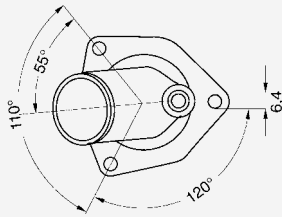

Typ 4164

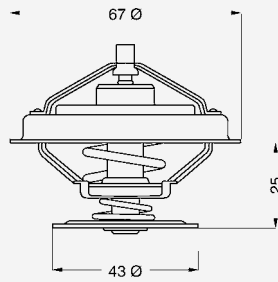

Typ 4165 mit Entlüftungsventil

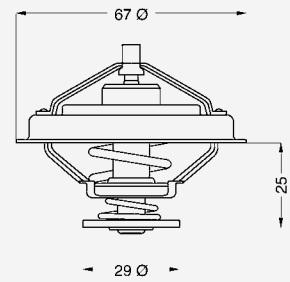

Typ 4166 mit Entlüftungsventil

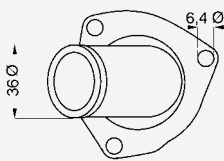

Typ 4168

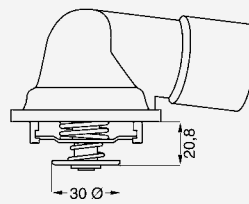

Typ 4175

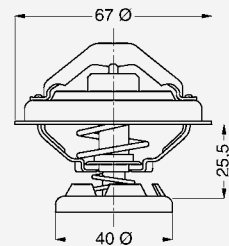

Typ 4176

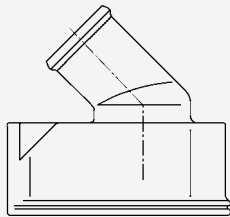

Typ 4177

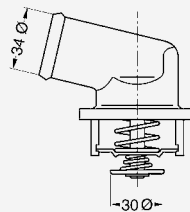

Typ 4178

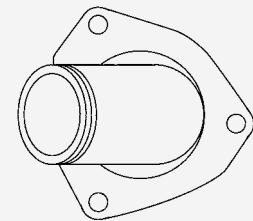

Typ 4180

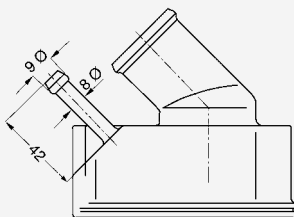

Typ 4183

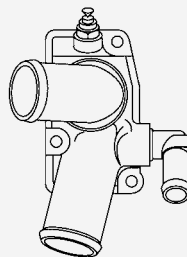

Typ 4188

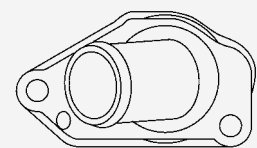

Typ 4189

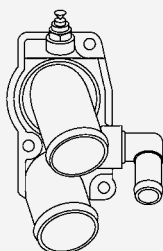

Typ 4193

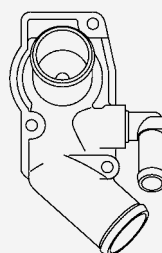

Typ 4198

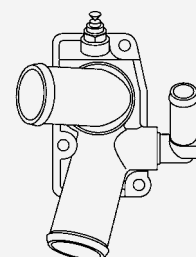

Typ 4201

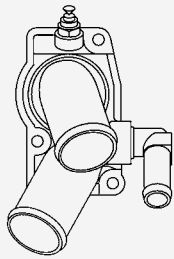
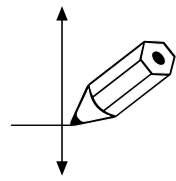

Typ 4207

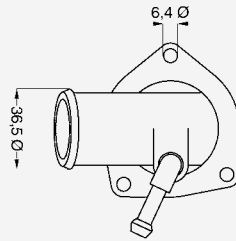

Typ 4208

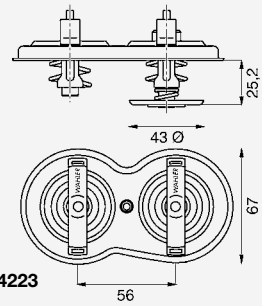

Typ 4223

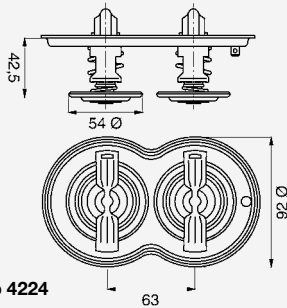

Typ 4224

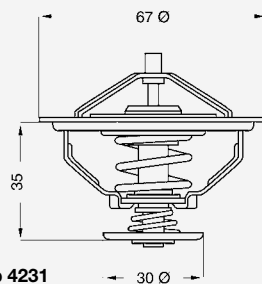

Typ 4231

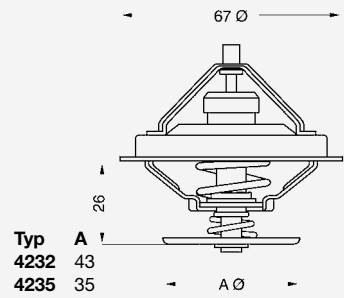

Typ 4232 43  
4235 35

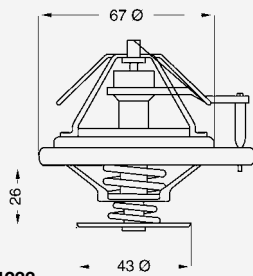

Typ 4233

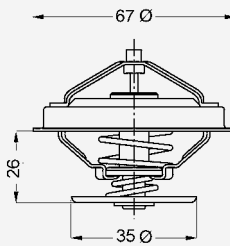

Typ 4236

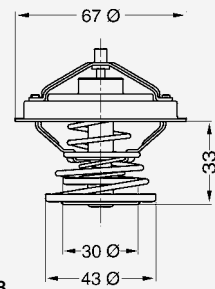

Typ 4238

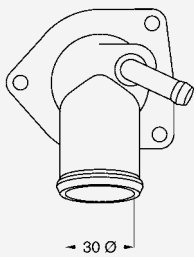

Typ 4242

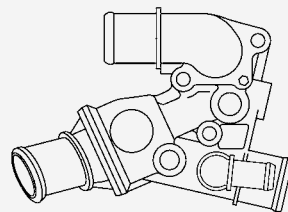

Typ 4246

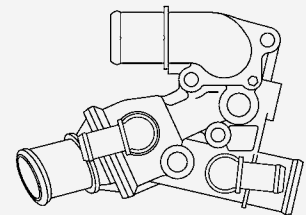

Typ 4247 mit M 16 x 1,5 / M 22 x 1,5  
4434 mit M 16 x 1,5  
4436 mit M 16 x 1,5 / M 16 x 1,5

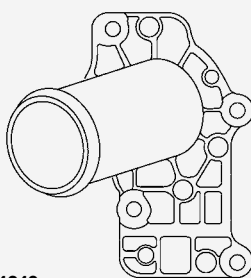

Typ 4249

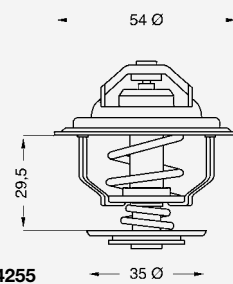

Typ 4255

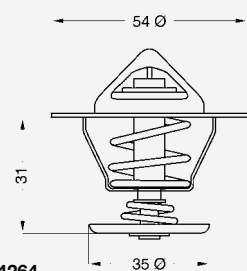

Typ 4264

# Assembly dimensions

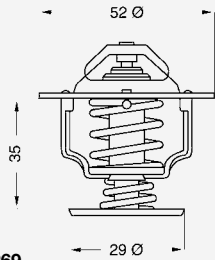

Typ 4269

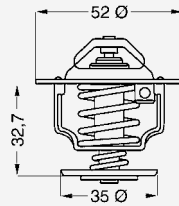

Typ 4270

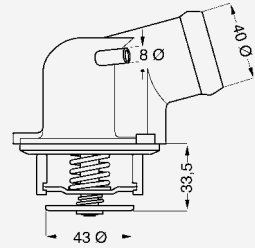

Typ 4275

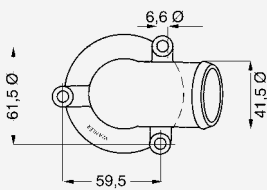

Typ 4276

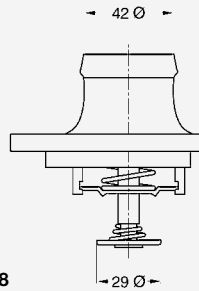

Typ 4278

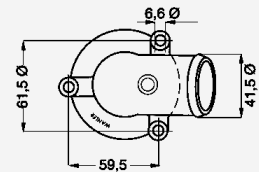

Typ 4279

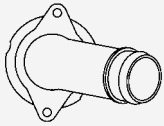

Typ 4280

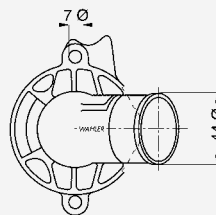

Typ 4281

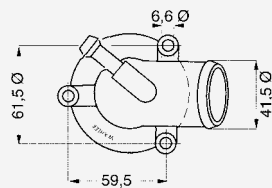

Typ 4286

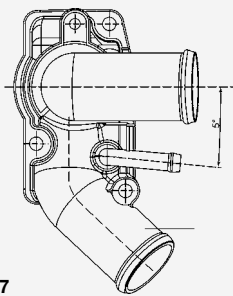

Typ 4297

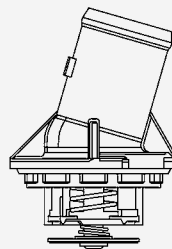

Typ 4298

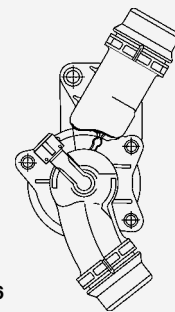

Typ 4326

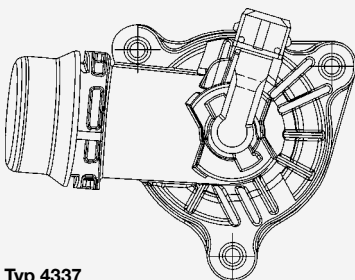

Typ 4337

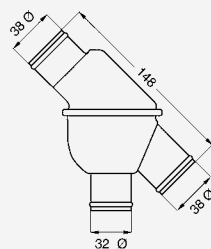

Typ 4341

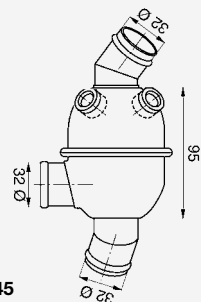

Typ 4345

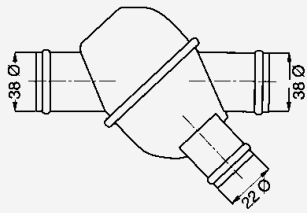
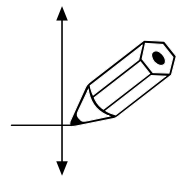

Typ 4351

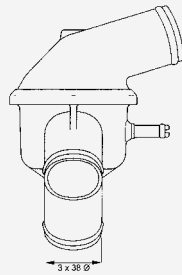

Typ 4368

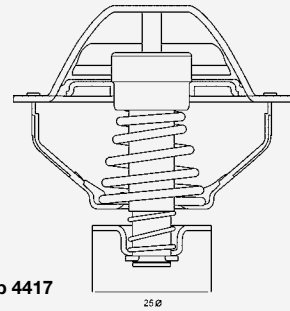

Typ 4417

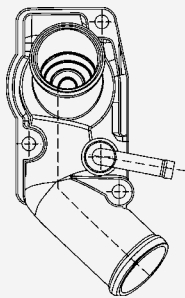

Typ 4433

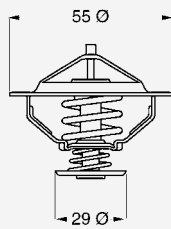

Typ 4446

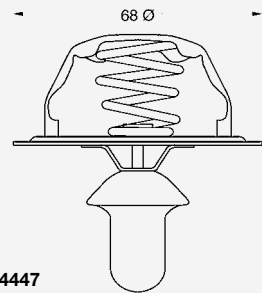

Typ 4447

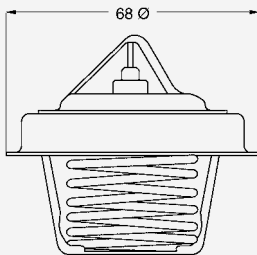

Typ 4449

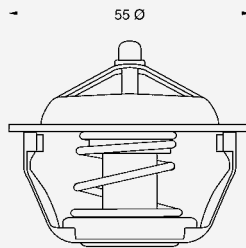

Typ 4450

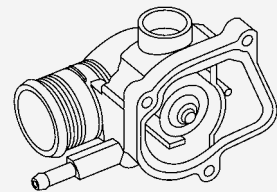

Typ 4453

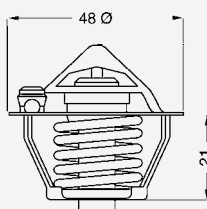

Typ 4457

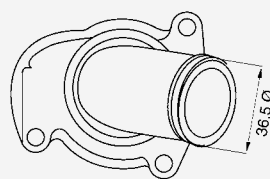

Typ 4459

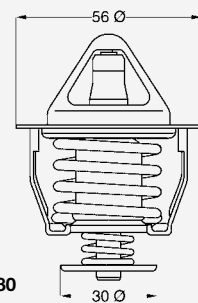

Typ 4480

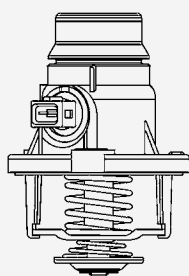

Typ 4508

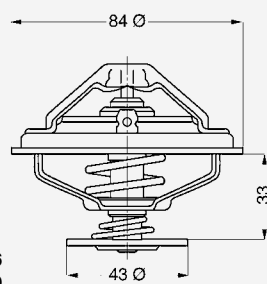

Typ 4516  
4519

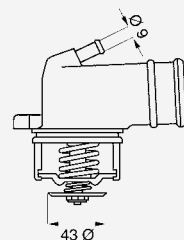

Typ 4517

# Assembly dimensions

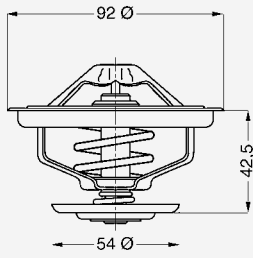

Typ 4520

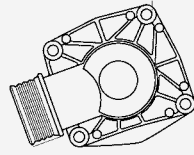

Typ 4594

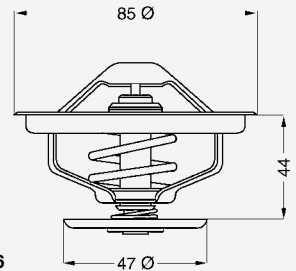

Typ 4596  
4530 mit Entlüftungskerbe

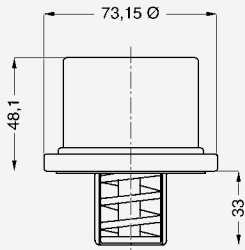

Typ 4619

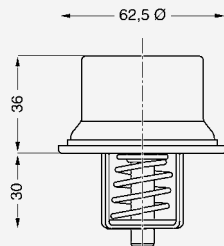

Typ 4621

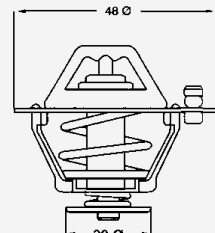

Typ 4634

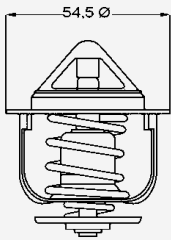

Typ 4635

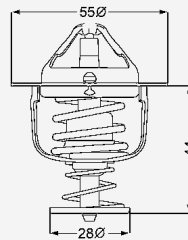

Typ 4637

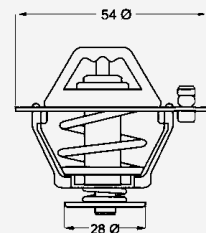

Typ 4638

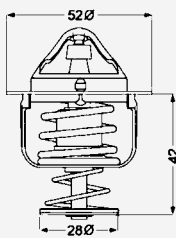

Typ 4639

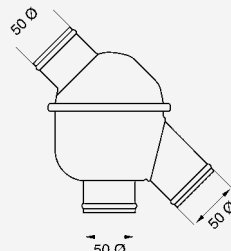

Typ 4663  
4684 mit Entlüftungs-  
kerbe mit Entlüftungs-  
ventil

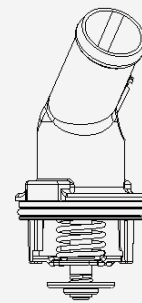

Typ 4814

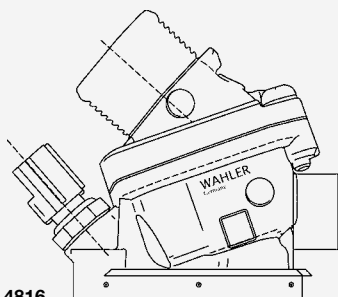

Typ 4816

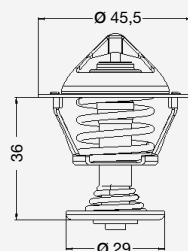

Typ 4821

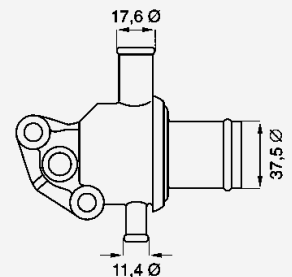

Typ 410007

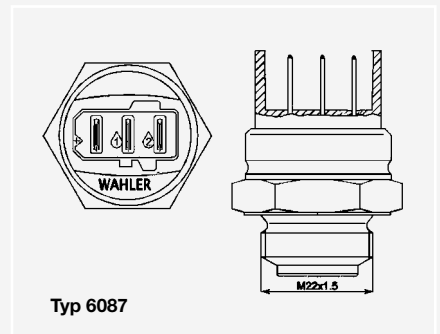
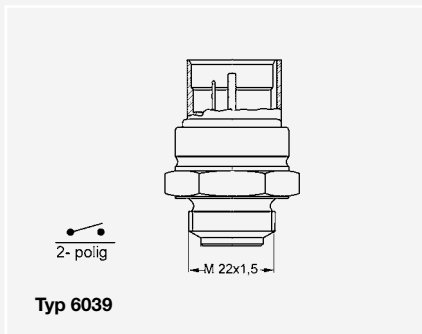
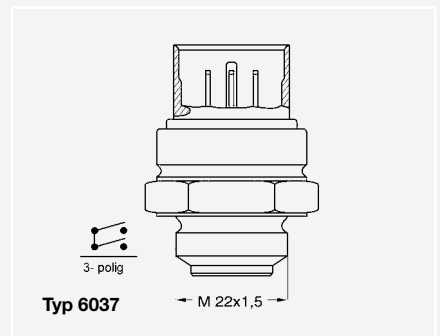
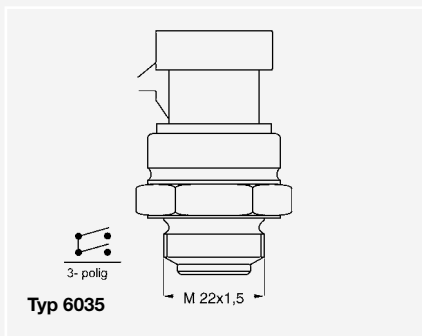
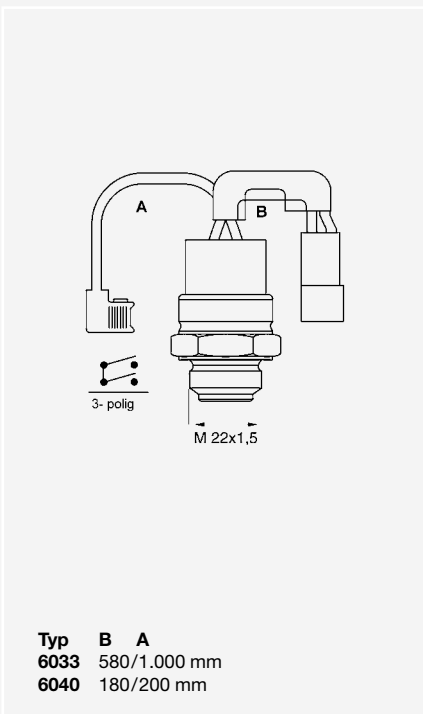
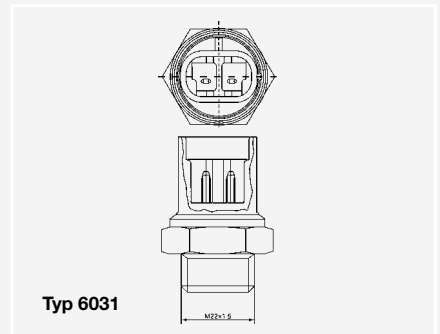
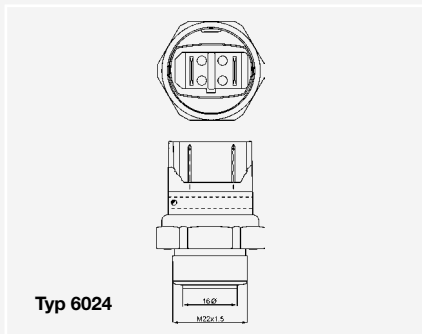
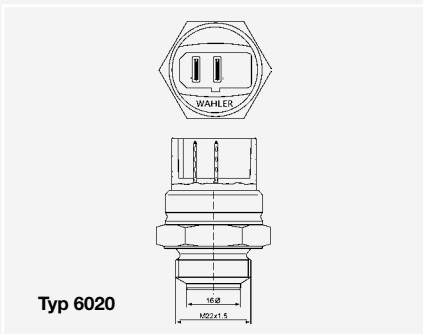
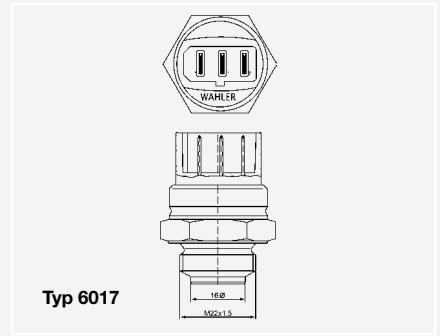
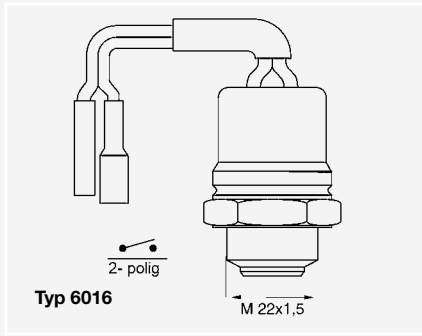
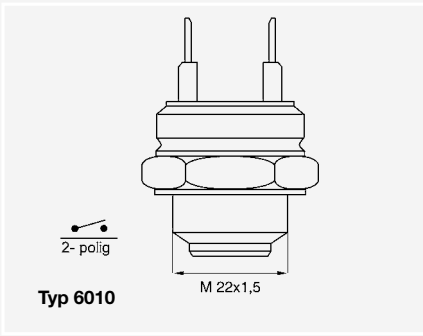
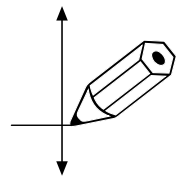

# Explanations

2 / 3 connections
2 / 4 pole
2-piece aluminum housing
A = actuator
EGR valve
automatic transmission
Chassis number
D = throttle flap
thermostat housing cover
seal
seal
DPF = Diesel particle filter
throttle flap
attached to the cylinder head
insert Thermostat
electrical
electrical heated
electrically controlled
no longer available
Europe
Excl. = exclude
for original number
housing
threat
Japan
catalyst
catalyst type
electrically heated thermostat
air conditioner
plastic cover
L = EGR-pipe
pipe throttle valve to cylinder hea
metal cover
with
engine number
upper
without
oil cooling
organisation number
diesel sootfilter
pneumatic
Retarder
particle filter
manual transmission
black
series / Standard equipment
available while stocks last
thermal
lower
USA
V = EGR valve
variant
water cooling
additionally required parts
XXX → = from
→ XXX = up to
XXX → XXX = from → up to
▲ = new part number
● = article to be discontinued

# Thermostates and Thermostwitches



Passenger Cars Catalog





## Key to article numbers

# 4116.87D1

Type no.

Opening temperature

Gasket type

## Design-Principle 3 Plate Thermostat

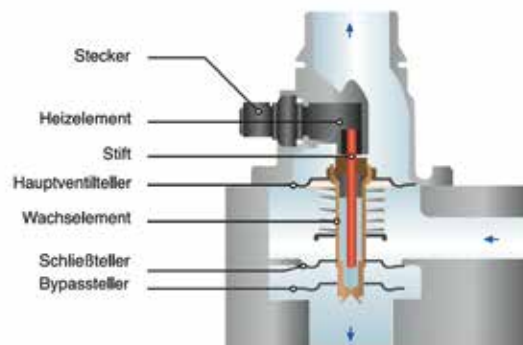

## Working Principle Cooling Water Thermostat

**Warm up period:** The engine enters the warm-up as soon as it is started. The thermostat is closed and the water circulates through the inner engine circuit.

**Normal operation:** The water temperature reaches the opening temperature of the thermostat. A small portion of the volumetric flow is fed through the radiator.

**Full temperature operation:** The bypass is sealed. The full volumetric flow is fed through the radiator.

**Reheating phase:** Maximum thermostat displacement occurs under special operating conditions such as reheating.

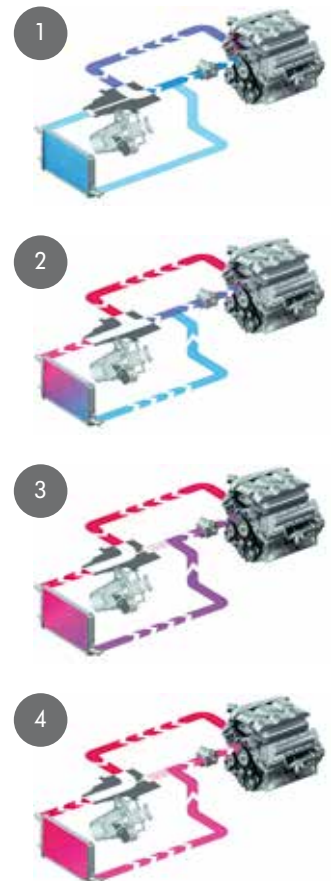

# Contents

<i>Thermostats</i>	1 - 218
<i>Thennoswitches</i>	220 - 282
<i>Cross references</i>	284 - 322
<i>Listing of gaskets</i>	324 - 327
<i>Supersession list</i>	328
<i>Main assembly dimensions</i>	329 - 340

Hersteller	Thermostat	Schalter	Hersteller	Thermostat	Schalter
ALFA ROMEO	2	220	MG	98	
AUDI	5	222	MINI	99	
AUTOBIANCHI	10	227	MITSUBISHI	100	
BMW	11		NISSAN	107	
CHEVROLET	20		OPEL	114	245
CHRYSLER	23		PEUGEOT	124	251
CITROËN	24	228	PIAGGIO	132	
DACIA	32	229	PLYMOUTH	133	
DAEWOO	35	230	PORSCHE	134	253
DAF	37		PROTON	136	
DAIHATSU	38		RENAULT	137	254
DODGE	41		ROLLS-ROYCE	155	
FIAT	42	231	ROVER	156	
FORD	51	238	SAAB	158	256
HONDA	59		SEAT	160	257
HYUNDAI	64		SKODA	165	261
INNOCENTI	66	239	SMART (MCC)	168	
IVECO	67		SSANGYONG	169	
JAGUAR		240	SUBARU	170	
JEEP	69		SUZUKI	174	
KIA	70		TALBOT	178	262
LADA	71	241	TOYOTA	179	
LANCIA	72	242	VAUXHALL	189	263
LANDROVER	75		VOLKSWAGEN	198	269
LEXUS	76		VOLVO	211	
LIGIER	77		WARTBURG	218	281
MAZDA	78		ZASTAVA		282
MERCEDES BENZ	82				

## About us

**BorgWarner Thermal Systems** is a leading supplier of components and systems for thermal management.

**BorgWarner Morse TEC** is the global leader of automotive chain systems and components for engine timing, automatic transmission and four-wheel drive applications.

**BorgWarner TorqTransfer Systems** is a leading manufacturer of torque distribution and management systems for four-wheel drive vehicles.

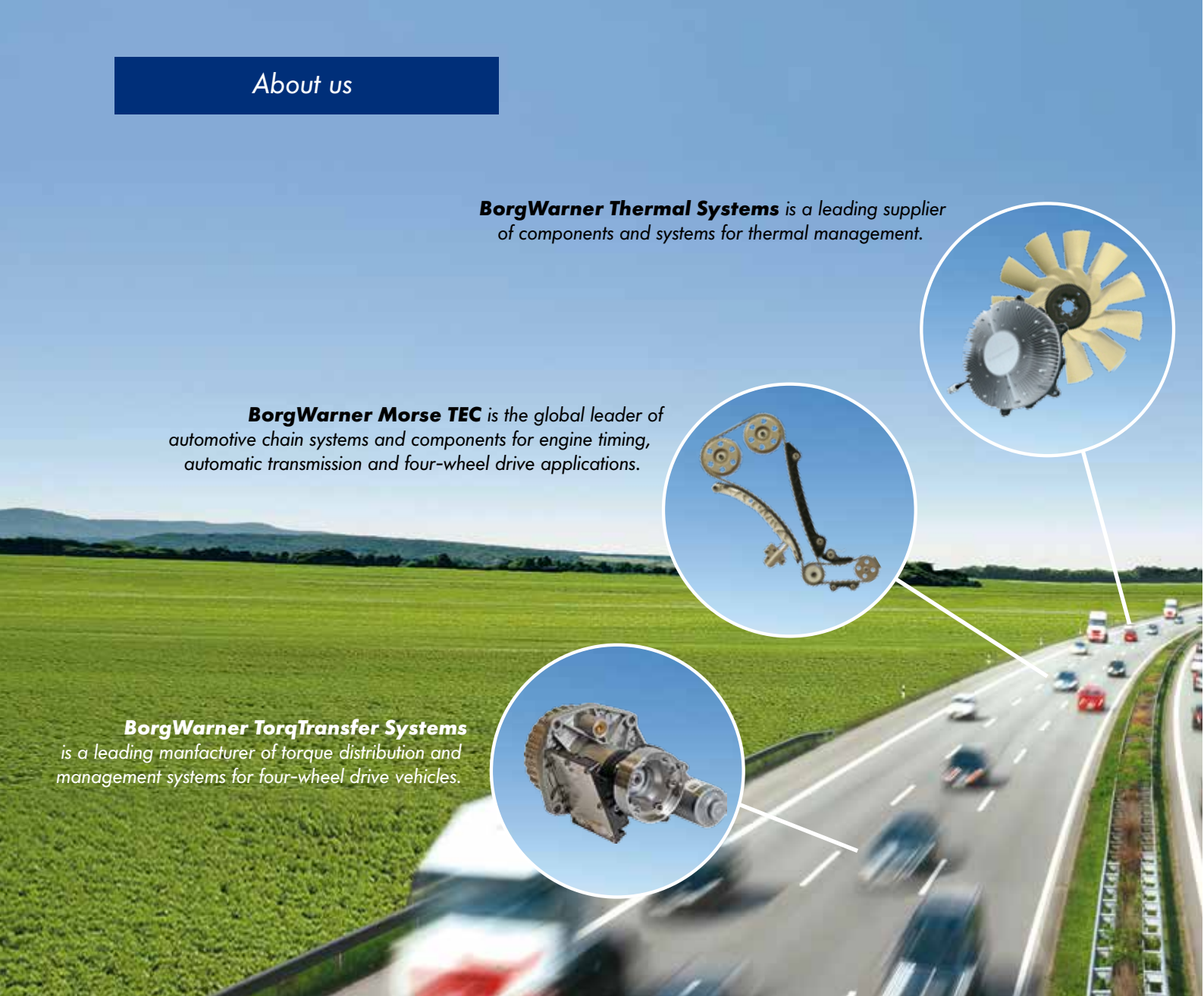
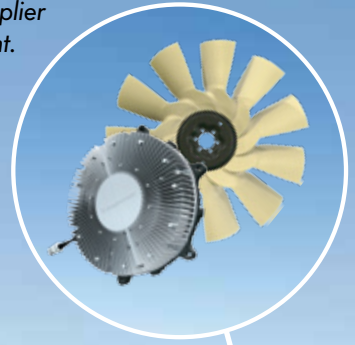



**BorgWarner Turbo Systems** is a leading manufacturer of turbochargers for passenger cars and commercial vehicle markets.

**BorgWarner Emissions Systems** is a leading manufacturer in the design and supply of exhaust gas recirculation (EGR) systems, ignition technology, diesel cold-start technology, cabin heaters and thermostats.

**BorgWarner Transmission Systems** supplies "shift quality" components and systems to virtually every automatic transmission manufacturer.

*Innovations for the aftermarket.  
From the product leader in the field of  
drive technology.*

*Many auto manufacturers all over the world agree on one thing: If they want their engines to meet the toughest emissions standards and break new ground in terms of fuel economy, if they want to combine excellent performance with a high level of reliability, then BorgWarner is the only choice. As product leader in the field of drive technology, we support the automotive industry in developing the vehicle generation of tomorrow. BorgWarner is also the perfect choice in the aftermarket. And not just because of the already legendary quality of our products. But also because of the selection, the range of services and the speed we offer our partners in the spare parts business.*

*Our solutions:  
precise, reliable, economical.*

*BorgWarner's Emissions Systems business unit is a leading global manufacturer and supplier of the latest exhaust gas emissions control systems, ignition technology, diesel cold-start technology, PTC interior heaters and thermostats for passenger vehicles and commercial vehicles all over the world. And with the product range of Wahler, which was acquired by BorgWarner in April 2014 and has been integrated into the Emissions Systems business unit, the product portfolio has been further expanded with a multitude of innovative solutions for the exhaust gas and temperature management of modern engines. Wahler will retain its product brand in the aftermarket segment.*

„Meine Wahl? Das Original.“  
“My Choice? The Original.”



## Thermostate und Thermoschalter

BorgWarner Emissions Systems liefert hochwertige Thermostate und Thermoschalter der Marke Wahler in Erstausrüsterqualität. Sie stehen für einwandfreie Funktion und hohe Zuverlässigkeit. Dank ihres optimalen Wärmemanagements sorgen sie für ein langes Motorleben. Vielfalt nach Maß – BorgWarner hat für alle gängigen Automobilmarken die geeigneten Ersatzteile!

## Thermostates and Thermoswitches

*BorgWarner Emissions Systems is a provider of Wahler brand thermostats and thermoswitches in OE quality. Our parts stand for proper functionality and outstanding reliability. Thanks to the optimum levels of heat management, they also ensure that engines live on, and on... Diversity made to measure – BorgWarner has the right parts for all current makes and models!*



Top OEM-  
quality

■ **Variety made to measure**

*BorgWarner Emissions Systems offers suitable Wahler spare parts for 62 auto- mobile brands!*

■ **BorgWarner worldwide**

*BorgWarner is represented in all the world's important markets with its own subsidiaries and a dense service network. For more information, visit [aftermarket.borgwarner.com](http://aftermarket.borgwarner.com)*

■ **Service products included**

*BorgWarner Emissions Systems knows its customers' needs and always supplies original Wahler thermostats together with the matching gasket!*

**ALFA ROMEO**

Engine

Ltr.

Year

Restriction\*

Thermostat

**33**

1.3	AR 30168, AR 30502, AR 30586, AR 30587	1.3	1983.06 - 1989.12		4003.86
1.5	AR 30508, AR 30588, AR 30146	1.5	1984.06 - 1989.12		4003.86

**75**

1.6	AR 06100	1.6	1985.05 - 1989.09		4160.83D
1.8	AR 06202	1.8	1985.05 - 1989.06		4160.83D
2.0	AR 06212	2.0	1985.05 - 1988.10		4160.83D

**90**

1.8	AR 06202	1.8	1984.10 - 1987.07		4160.83D
2.0 i.e.	AR 01713, AR 06212	2.0	1984.10 - 1987.07		4160.83D

**145 (930)**

1.6 i.e. 16V T.S.	AR 67601, AR 38201	1.6	1996.12 - 2001.01		410514.88D
1.8 i.e. 16V	AR 32201	1.8	1998.03 - 2001.01		410514.88D
1.9 JTD	AR 32302	1.9	1999.02 - 2001.01		410512.88D
1.9 TD	AR 33601, AR 67501	1.9	1994.10 - 1999.02	Ölkühlung	410692.71D
2.0 16V Quadrifoglio	AR 32301	2.0	1998.03 - 2001.01		410514.88D

**146 (930)**

1.6 i.e. 16V T.S.	AR 67601, AR 38201	1.6	1996.11 - 2001.01		410514.88D
1.8 i.e. 16V T.S.	AR 32201	1.8	1998.03 - 2001.01		410514.88D
1.9 JTD	AR 32302	1.9	1999.02 - 2001.01		410512.88D
1.9 TD	AR 33601, AR 67501	1.9	1994.12 - 1999.02	Ölkühlung	410692.71D
2.0 16V Quadrifoglio	AR 32301	2.0	1998.03 - 2001.01		410514.88D

**147 (937)**

1.6 16V T.SPARK (937AXB1A)	AR 32104	1.6	2001.01 - 2010.03		410514.88D
1.6 16V T.SPARK ECO (937AXA1A)	AR 37203	1.6	2001.01 - 2010.03		410590.88D
1.9 JTD	182 B9.000	1.9	2003.03 - 2010.03		410511.88D
1.9 JTD (937AXD1A)	937 A2.000	1.9	2001.04 - 2010.03		410511.88D
1.9 JTD 16V	192 A5.000	1.9	2002.11 - 2010.03		411773.88D ▲
1.9 JTD 16V	937 A4.000	1.9	2003.09 - 2004.09		411773.88D ▲
1.9 JTD 16V	192 B1.000	1.9	2004.10 - 2010.03		411773.88D ▲
1.9 JTDM 16V	937 A5.000	1.9	2005.07 - 2010.03		411773.88D ▲
1.9 JTDM 16V	937 A6.000	1.9	2008.06 - 2010.03		411773.88D ▲
1.9 JTDM 8V	937 A3.000	1.9	2005.07 - 2010.03		411773.88D ▲
2.0 16V T.SPARK (937AXC1_)	AR 32310	2.0	2001.01 - 2010.03		410514.88D

**155 (167)**

1.9 TD (167.A3)	AR 67501	1.9	1993.04 - 1997.12	Ölkühlung	410692.71D
-----------------	----------	-----	-------------------	-----------	------------

**156 (932)**

1.6 16V T.SPARK	AR 32102, AR 32103, AR 32104, AR 67601	1.6	1997.09 - 2006.05		410514.88D
1.8 16V T.SPARK	AR 32201, AR 32205	1.8	1997.09 - 2006.05		410514.88D
1.9 JTD	AR 32302	1.9	1997.09 - 2000.10		410512.88D
2.0 16V T.SPARK	AR 32301, AR 32310	2.0	1997.09 - 2002.03		410514.88D
2.0 Twin Spark	AR 32303	2.0	1997.11 - 2000.04		410514.88D
2.4 JTD	AR 32501	2.4	1997.09 - 2003.09		410512.88D

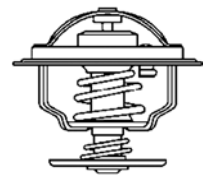

# ALFA ROMEO

	Engine	Ltr.	Year	Restriction*	Thermostat
<b>159</b>					
1.8 MPI	939 A4.000	1.8	2007.03 - 2011.11		<b>4431.105D</b>
1.9 JTDM 16V	937 A8.000, 939 A2.000, 939 A8.000	1.9	2005.09 - 2011.11		<b>410049.88D</b>
1.9 JTDM 8V	937 A7.000, 939 A1.000, 939 A7.000	1.9	2005.09 - 2011.11		<b>410049.88D</b>
1.9 JTS	939 A6.000	1.9	2005.09 - 2011.11		<b>411193.82D</b>
2.2 JTS	939 A5.000	2.2	2005.09 - 2011.11		<b>411193.82D</b>
<b>1750</b>					
1750	AR 00548	1.8	1968.03 - 1972.10		<b>4008.79D</b>
<b>ALFASUD</b>					
1.3	AR 30184	1.3	1976.09 - 1981.12		<b>4003.86</b>
1.4	AR 30164, AR 30168	1.4	1978.05 - 1989.12		<b>4003.86</b>
1.5	AR 30124, AR 30128, AR 30146	1.5	1978.05 - 1987.12		<b>4003.86</b>
<b>ALFETTA</b>					
1.6	AR 01600	1.6	1975.01 - 1984.12		<b>4008.79D</b>
1.8	AR 01608, AR 01608 X	1.8	1974.01 - 1984.12		<b>4008.79D</b>
1.8	AR 01678	1.8	1979.10 - 1984.12		<b>4008.79D</b>
2.0	AR 01623, AR 01655, AR 01713, AR 10520	2.0	1977.03 - 1986.01		<b>4008.79D</b>
<b>AR 6 / AR 8</b>					
2.4 D	8140.61.200, 8144.61.200	2.4	1978.04 - 1985.12		<b>4008.79D</b>
2.4 D	8140.61.200, 8144.61.200	2.4	1986.01 - 1986.08		<b>4151.79D</b>
2.4 TD	8140.21.200 D.I.	2.4	1985.04 - 1985.12		<b>4008.79D</b>
2.4 TD	8140.21.200 D.I.	2.4	1986.01 - 1989.12		<b>4151.79D</b>
2.4 TD	8144.21.220	2.4	1986.09 - 1989.12		<b>4151.79D</b>
2.5 D	8144.67.220	2.5	1986.03 - 1989.12		<b>4151.79D</b>
<b>ARNA</b>					
1.2	AR 30500, AR 31000	1.2	1985.01 - 1986.12		<b>4003.86</b>
1.3 TI	AR 30168, AR 31010	1.3	1983.03 - 1986.12		<b>4003.86</b>
<b>BRERA</b>					
2.2 JTS	939 A5.000	2.2	2006.01 -		<b>411193.82D</b>
<b>GIULIA</b>					
1300 Super (115)	AR 00530	1.3	1974.01 - 1978.12		<b>3067.83</b>
1300 TI (105, 39)		1.3	1969.04 - 1975.07		<b>3000.83</b>
1600 Super (105, 14)	AR 00526	1.6	1964.06 - 1969.08		<b>3067.83</b>
<b>GIULIETTA</b>					
1.3	AR 01644	1.3	1977.10 - 1983.06		<b>4160.83D</b>
1.6	AR 01600	1.6	1977.10 - 1985.04		<b>4160.83D</b>
1.8	AR 01678	1.8	1979.04 - 1985.04		<b>4160.83D</b>
1.8 Turbo	AR 01354	1.8	1984.01 - 1985.12		<b>4160.83D</b>
2.0	AR 11671, AR 01655	2.0	1980.06 - 1985.04		<b>4160.83D</b>
2.0 Turbo	AR 01699	2.0	1983.07 - 1984.06		<b>4160.83D</b>



**ALFA ROMEO**

Engine

Ltr.

Year

Restriction\*

Thermostat

**GIULIETTA (940)**

1.4 BiFuel	198 A4.000	1.4	2011.12 -		410871.80D ▲
1.4 TB	198 A4.000, 940 A2.000, 940 A6.000, 940 B1.000, 940 B7.000, 940 B8.000, 955 A8.000	1.4	2010.04 -		410871.80D ▲

**GT**

1300 Junior (105)	AR 00530	1.3	1966.01 - 1977.12		3067.83
1600 (105, 115)	AR 00526 S, AR 00536	1.6	1963.03 - 1977.12		3067.83
A 1600 (105)	AR 10538	1.6	1965.01 - 1970.12		3067.83

**GT (937)**

1.8 TS	AR 32205	1.8	2003.11 - 2010.09		410514.88D
1.9 JTD	937 A5.000, 937 A6.000	1.9	2003.11 - 2010.09		411773.88D ▲

**GTV (116)**

2.0	AR 06212, AR 01655	2.0	1978.07 - 1986.01		4008.79D
-----	--------------------	-----	-------------------	--	----------

**GTV (916)**

1.8 16V	AR 32201	1.8	1998.05 - 2005.10		410514.88D
2.0 T.SPARK 16V	AR 32301, AR 32310	2.0	1995.06 - 2005.10		410514.88D

**MITO (955)**

0.9	312 A2.000	0.9	2011.07 -		410090.88D
1.3 JTDM	199 A3.000	1.3	2008.09 -		410048.88D
1.3 JTDM	199 B1.000	1.3	2009.10 -		411774.88D ▲
1.4	199 A6.000, 350 A1.000, 955 A1.000	1.4	2008.09 -		410090.88D
1.4	955 A6.000	1.4	2010.08 -		410871.80D ▲
1.4	955 A9.000	1.4	2011.05 -		410090.88D
1.4 TB	940 A2.000, 955 A2.000, 955 A7.000, 955 A8.000	1.4	2009.10 -		410871.80D ▲

**MONTREAL**

2.6	AR 10832	2.6	1972.12 - 1979.03		4008.79D
-----	----------	-----	-------------------	--	----------

**SPIDER (105)**

1750	AR 00548	1.8	1967.01 - 1971.12		4008.79D
------	----------	-----	-------------------	--	----------

**SPIDER (115)**

1600	AR 01563	1.6	1990.01 - 1993.12		4160.83D
------	----------	-----	-------------------	--	----------

**SPIDER (916)**

1.8 16V	AR 32201	1.8	1998.05 - 2005.04		410514.88D
2.0 T.SPARK 16V	AR 32301, AR 32310	2.0	1995.06 - 2005.04		410514.88D

**SPIDER (939)**

2.2 JTS	939 A5.000	2.2	2006.09 -		411193.82D
---------	------------	-----	-----------	--	------------

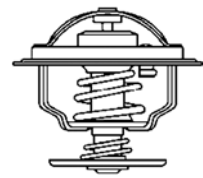

# AUDI

	Engine	Ltr.	Year	Restriction*	Thermostat
<b>80 (quattro)</b>					
1.3	EP, ZA, ZF	1.3	1972.05 - 1978.07		4264.87D
1.3	FY, FZ	1.3	1978.09 - 1981.07		3091.92D
1.4	SE	1.4	1986.08 - 1988.07		4264.87D
1.5	YJ, ZB, ZC	1.5	1972.05 - 1975.08		4264.87D
1.6	ABB, ABM, DT, PP, RN, SA, WV, YN, YP, YT, YY	1.6	1975.09 - 1991.10		4264.87D
1.6 D	JK, CR	1.6	1980.08 - 1991.08		4253.87D
1.6 E	ADA	1.6	1993.06 - 1996.01		4264.87D
1.6 GLE	YZ	1.6	1979.01 - 1986.12		4264.87D
1.6 GT	XX	1.6	1973.09 - 1976.07		4264.87D
1.6 GTE	YS	1.6	1976.01 - 1978.07		4264.87D
1.6 TD	CY	1.6	1981.08 - 1986.05		4253.87D
1.6 TD	RA, SB	1.6	1986.09 - 1991.08		4253.87D
1.8	DS, JN, JV, NE, RU, SD, SF	1.8	1983.01 - 1990.08		4264.87D
1.8 E / GTE	DZ, PV	1.8	1984.08 - 1991.08		4264.87D
1.8 S	JN, NE, PM, SF	1.8	1986.09 - 1991.10		4264.87D
1.9 CD-5S	WN	1.9	1981.09 - 1983.07		4116.87D1
1.9 D	1Y	1.9	1989.08 - 1991.08		4253.87D
1.9 TD	AAZ, 1Z	1.9	1991.09 - 1994.12		4253.87D
1.9 TDI	1Z	1.9	1991.09 - 1996.01		4253.87D
2.0	JS, HP	2.0	1983.10 - 1984.09		4116.87D1
2.0	3A, AAD, ABT, ADW	2.0	1988.08 - 1996.01		4264.87D
2.0 E	3A, ABK	2.0	1988.08 - 1996.01		4264.87D
2.0 E 16V	6A, ACE	2.0	1990.03 - 1992.07		4264.87D
2.2	KK, KL, WE	2.2	1980.10 - 1984.07		4116.87D1
2.3	NG	2.3	1987.10 - 1989.07		4116.87D1
2.3 E	NG	2.3	1991.09 - 1996.01		4116.87D1
2.6	ABC, ACZ	2.6	1992.06 - 1996.01		4274.87D
2.8	AAH	2.8	1991.09 - 1996.01		4274.87D
RS2	ADU	2.2	1994.03 - 1995.05		4116.87D1
S2	ABY	2.2	1993.02 - 1995.07		4116.87D1
<b>90 (quattro)</b>					
1.6 TD	CY, RA, SB	1.6	1985.10 - 1991.09		4253.87D
2.0	HP, JS, PS, SK	2.0	1984.08 - 1991.09		4116.87D1
2.0	6A	2.0	1989.08 - 1990.07		4264.87D
2.0 20 V	NM	2.0	1988.08 - 1991.09		4116.87D1
2.2	HY, KV, KX	2.2	1984.10 - 1987.03		4116.87D1
2.2 E	JT, KV	2.2	1985.08 - 1987.03		4116.87D1
2.3 E	NG	2.3	1987.04 - 1991.09		4116.87D1
2.3 E 20V	7A	2.3	1988.06 - 1991.09		4116.87D1
<b>100 1968 → 1983</b>					
1.6	YM	1.6	1975.01 - 1976.07		4256.80D
1.6	YV	1.6	1976.08 - 1983.02		4264.87D
1.8	ZU, ZV, ZX, ZZ	1.8	1968.11 - 1976.07		4006.82D
1.9	WH, ZJ, ZP	1.9	1970.07 - 1982.07		4006.82D
2.0	WA	2.0	1976.06 - 1980.07		4006.82D
2.0 D	CN	2.0	1978.08 - 1983.02		4116.87D1
2.1	WE, WB, WC, WG	2.1	1977.03 - 1983.02		4088.80D
<b>100 1982 → 1990 (quattro)</b>					
1.8	4B, DR, DS, RS, JW, NP, PH, SH	1.8	1982.08 - 1990.11		4264.87D
1.9	WH	1.9	1982.08 - 1984.07		4116.87D1

**AUDI**
**Engine**
**Ltr.**
**Year**
**Restriction\***
**Thermostat**

2.0	KP, RT, SL	2.0	1984.08 - 1990.11		4116.87D1
2.0 D	CN	2.0	1982.08 - 1990.11		4116.87D1
2.0 D Turbo	DE, NC	2.0	1982.08 - 1990.11		4116.87D1
2.0 E	KP, RT	2.0	1985.01 - 1990.11		4116.87D1
2.0 TD	DE, NC	2.0	1983.03 - 1990.11		4116.87D1
2.1	KF, WC	2.1	1982.08 - 1984.07		4116.87D1
2.2	HX, KF, KU, KZ, WU	2.2	1982.08 - 1990.11		4116.87D1
2.2 E	PX	2.2	1985.08 - 1986.07		4116.87D1
2.2 E Turbo	MC	2.2	1986.08 - 1990.11		4116.87D1
2.2 Turbo	MC	2.2	1986.08 - 1990.11		4116.87D1
2.3	AAR, NF	2.3	1986.08 - 1990.11		4116.87D1
2.3 E	AAR, NF	2.3	1986.08 - 1990.11		4116.87D1
2.4 D	3D	2.4	1989.08 - 1991.07		4116.87D1
2.5 TDI	1T	2.5	1990.01 - 1990.11		4116.87D1

**100 1990 → 1994 (quattro)**

2.0	AAE	2.0	1990.12 - 1994.06		4264.87D
2.0 E	AAD, AAE, ABK	2.0	1990.12 - 1994.06		4264.87D
2.0 E 16V	ACE	2.0	1992.01 - 1994.06		4264.87D
2.3 E	AAR	2.3	1990.12 - 1994.06		4116.87D1
2.4 D	AAS	2.4	1990.12 - 1994.06		4116.87D1
2.5 TDI	AAT, ABP	2.5	1990.12 - 1994.06		4116.87D1
2.6	ABC, ACZ	2.6	1992.03 - 1994.06		4274.87D
2.6 E	AAH, ACZ	2.6	1990.08 - 1994.06		4274.87D
2.8 E	AAH	2.8	1990.12 - 1994.06		4274.87D
S4 Turbo	AAN	2.2	1991.08 - 1994.06		4116.87D1
S4 V8	ABH	4.2	1992.10 - 1994.06		4274.87D
S4 V8	AEC	4.2	1994.03 - 1994.06		4274.87D

**200 (quattro)**

2.1 5 E	WC	2.1	1979.10 - 1984.07		4116.87D1
2.1 5 T	WJ	2.1	1979.10 - 1982.08		4088.87D
2.1 Turbo	JY, KG	2.1	1983.08 - 1988.01		4116.87D1
2.2	KU	2.2	1984.08 - 1985.07		4116.87D1
2.2 20V Turbo	3B	2.2	1989.03 - 1990.12		4116.87D1
2.2 Turbo	1B, 2B, MC	2.2	1988.02 - 1991.12		4116.87D1
2.3	NF	2.3	1986.11 - 1991.09		4116.87D1

**A1 (8XA, 8X1)**

1.6 TDI	CAYC	1.6	2010.05 - 2010.10	mit Gehäuse	410536.92D
1.6 TDI	CAYC	1.6	2010.05 - 2010.10	ohne Gehäuse	410537.92D
1.6 TDI	CAYC	1.6	2010.11 -		410845.92D
1.6 TDI	CAYB	1.6	2011.03 -		410845.92D
2.0 TDI	CFHB, CFHD	2.0	2011.09 -		410845.87D

**A2**

1.2 TDI	ANY	1.2	2001.03 - 2005.08		4264.87D
1.4	BBY, AUA	1.4	2000.02 - 2005.08	mit Gehäuse	410475.87D
1.4 TDI	ATL, BHC	1.4	2000.02 - 2005.08		4264.87D

**A3 (8L)**

1.6	AEH, AKL	1.6	1996.09 - 2003.05		3141.87D
1.8	AGN, APG	1.8	1996.09 - 2003.05		3141.87D
1.8 T	AGU, AJQ, APP, AQA, ARY, ARX, AUM, AUQ	1.8	1996.12 - 2003.05		3141.87D

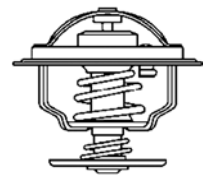

# AUDI

	Engine	Ltr.	Year	Restriction*	Thermostat
1.9 TDI	AGR, AHF, ALH, ATD, ASV, ASZ, AXR	1.9	1996.09 - 2003.05		4264.87D
S3	AMK, APY	1.8	1999.03 - 2002.04		3141.87D
S3	BAM	1.8	2001.10 - 2003.05		3141.87D
<b>A3 (8P)</b>					
1.6	BGU, BSE, BSF, CCSA, CMXA	1.6	2003.05 - 2012.08		3141.87D
1.6	BSE	1.6	2008.09 -		3141.87D
1.6 TDI	CAYB, CAYC	1.6	2009.01 - 2010.05		410537.92D
1.6 TDI	CAYB, CAYC	1.6	2010.05 - 2012.08		410845.92D
1.9 TDI	BKC, BXE	1.9	2004.04 - 2010.05		4264.87D
1.9 TDI	BLS	1.9	2008.04 -		4820.87D
2.0 FSI	BVZ, BVY	2.0	2003.05 - 2008.06		411186.87D
2.0 TDI	AZV, BMN, BUY	2.0	2003.05 - 2008.06		3472.87D
2.0 TDI	BMM	2.0	2005.06 - 2008.06		4820.87D
2.0 TDI	CBAA, CBAB, CBAB	2.0	2008.04 - 2009.07		3472.87D
2.0 TDI	CFFA, CFFB, CFGB	2.0	2008.04 -		410845.87D
2.0 TDI 16V	CFFB, CLJA	2.0	2003.05 - 2012.08		410845.87D
2.0 TDI 16V	CBAB	2.0	2004.08 - 2012.08		3472.87D
2.0 TDI 16V	BKD	2.0	2004.08 - 2009.07		3472.87D
2.0 TFSI	AXX, BWA, BPY	2.0	2004.09 -		411187.87D
3.2 V6	BDB, BMJ, BUB	3.2	2003.07 - 2009.05		4455.80D
<b>A4 (quattro)</b>					
1.6	ADP, AHL, ALZ, ANA, ARM	1.6	1994.11 - 2001.09		3141.87D
1.8	ADR, AFY, APT, ARG, AVV	1.8	1995.01 - 2001.09		3141.87D
1.8 T	AEB, AJL, ANB, APU, ARK, AWT	1.8	1995.01 - 2001.09		3141.87D
1.9 DUO	AHU	1.9	1998.03 - 2001.09		4264.87D
1.9 TDI	1Z, AFF, AFN, AHU, AHH, AJM, ATJ, AVB, AVF, AVG, AWX, BKE, BRB	1.9	1995.01 - 2008.06		4264.87D
2.0 TDI	BNA, BRF, BRD, BVA, BVF, BVG	2.0	2004.11 - 2008.06		3472.87D
2.0 TDI	BPW, BRC	2.0	2004.11 - 2009.03		4264.87D
2.0 TDI 16V	BLB, BRE	2.0	2004.11 - 2008.06		3472.87D
2.0 TFSI	BGB, BPG, BPJ, BUL, BWE, BWT, BYK	2.0	2004.11 - 2008.06		411186.87D
2.0 TFSI 16V	BWE, BWT	2.0	2006.01 - 2009.03		411186.87D
2.4	AFM, AGA, AJG, ALF, AML, AMM, APS, APZ, ARJ, BDV	2.4	1995.07 - 2001.09	Chassis No. →8D-X-315 000	4274.87D
2.4	AFM, AGA, AJG, ALF, AML, AMM, APS, APZ, ARJ, BDV	2.4	1997.03 - 2005.12	Chassis No. 8D-X-315 001→	4274.92D
2.5 D	AKE	2.5	2000.10 - 2003.05		4274.87D
2.5 TDI	AFB, AKE, AKN, AYM, BAU, BCZ, BDG, BDH, BFC	2.5	1997.09 - 2006.05		4274.87D
2.6	ABC, ACZ	2.6	1995.01 - 2001.09		4274.87D
2.8	AAH, ACK, ALG, AMX, APR, AQD	2.8	1995.01 - 1997.07		4274.87D
2.8	ATX	2.8	1999.03 - 2000.09		4274.92D
3.0	ASN, AVK, BBJ	3.0	2000.11 - 2004.12		4814.92D
RS4	ASJ, AZR	2.7	2000.05 - 2001.09		4274.87D
S4	AGB, AZB	2.7	1997.09 - 2001.09		4274.87D
<b>A4 (8K2, B8)</b>					
2.0 TDI	CAGB, CAHB, CAGC	2.0	2007.11 - 2009.08		410396.82D
<b>A6 (quattro)</b>					
1.8	ADR, AFY, AJP, AQE, ARH	1.8	1995.12 - 2005.01		3141.87D
1.8 T	AEB, ANB, APU, ARK, AWT, AJL	1.8	1997.01 - 2005.01		3141.87D
1.9 TDI	1Z, AFN, AHU, AJM, AVF, AVG, AWX	1.9	1994.06 - 2005.01		4264.87D

# Thermostate

## AUDI

	Engine	Ltr.	Year	Restriction*	Thermostat
2.0	AAE, ABK, ADW	2.0	1994.06 - 1997.12		4264.87D
2.0 16V	ACE	2.0	1994.06 - 1997.12		4264.87D
2.0 TDI	BLB, BRE, BNA, BRF	2.0	2004.07 - 2008.10		3472.87D
2.0 TDI	CAHA, CAHB, CAGB	2.0	2008.10 - 2009.08		410396.82D
2.0 TFSI	BPJ, BYK	2.0	2005.06 - 2011.08		411186.87D
2.3	AAR	2.3	1994.06 - 1995.12		4116.87D1
2.4	AFM, AGA, AJG, ALF, ALW, AML, AMM, APC, APS, APZ, ARJ, ARN, ASM, BDV	2.4	1995.07 - 2005.01	Chassis No. →4B-X-160 000	4274.87D
2.4	AFM, AGA, AJG, ALF, ALW, AML, AMM, APC, APS, APZ, ARJ, ARN, ASM, BDV	2.4	1997.02 - 2005.01	Chassis No. 4B-X-160 001→	4274.92D
2.5 TDI	AAT, AEL	2.5	1994.06 - 1997.12		4116.87D1
2.5 TDI	AFB, AKE, AKN, AYM, BAU, BCZ, BDG, BDH, BFC, BND	2.5	1997.07 - 2005.01		4274.87D
2.7 T	AJK, ARE, AZA, BES	2.7	1997.12 - 2005.01		4274.87D
2.8	AAH, ACK, AEJ, AFC, AGE, ALG, AMX, APR, AQD	2.8	1994.06 - 2005.01		4274.87D
2.8	ATX, BBG	2.8	1999.07 - 2005.01		4274.92D
3.0	ASN, BBJ	3.0	2001.06 - 2006.05		4814.92D
4.2	ARS, ASG	4.2	1998.11 - 2005.01		4274.87D
RS6	BCY	4.2	2002.07 - 2005.01		4274.82D
S6	ANK, AQJ	4.2	1999.09 - 2005.01		4274.87D
S6 4.2	AEC	4.2	1994.06 - 1997.12		4274.87D
S6 Plus	AHK	4.2	1996.04 - 1997.12		4274.87D
S6 Turbo	AAN	2.2	1994.06 - 1997.12		4116.87D1
<b>A8 (quattro)</b>					
2.5 TDI	AFB, AKE, AKN	2.5	1997.01 - 2002.09		4274.87D
2.8	AAH, AEJ, ACK, ALG, AMX, APR, AQD	2.8	1994.03 - 2002.09		4274.87D
3.0	ASN, BBJ	3.0	2003.07 - 2005.05		4814.92D
3.3 TDI	AKF	3.3	2000.06 - 2002.09		4274.87D
3.7	AEW, AKC, AKJ, AQG, BFL	3.7	1995.07 - 2002.09		4274.87D
4.2	ABZ, AEM, AKG, ARU, AQF, AUW, AUX	4.2	1994.03 - 2002.09		4274.87D
4.2	ARU, BFM	4.2	1999.02 - 2010.07		4274.82D
S 8	AHC, AKH	4.2	1996.07 - 1999.06		4274.87D
S 8	AQH, AVP	4.2	1999.06 - 2002.09		4274.82D
<b>ALLROAD</b>					
2.5 TDI	AKE, BAU, BCZ	2.5	2000.05 - 2005.08		4274.87D
2.7 T	ARE, BES	2.7	2000.05 - 2005.08		4274.87D
<b>CABRIOLET</b>					
1.8	ADR	1.8	1997.01 - 2000.08		3141.87D
1.9 TDI	1Z, AHU	1.9	1995.06 - 2000.08		4264.87D
2.0 16V	ACE	2.0	1995.06 - 1996.07		4264.87D
2.0 E	ABK	2.0	1993.01 - 1998.07		4264.87D
2.3 E	NG	2.3	1991.05 - 1994.07		4116.87D1
2.6	ABC, ACZ	2.6	1993.06 - 2000.08		4274.87D
2.8	AAH	2.8	1992.11 - 2000.08		4274.87D
<b>COUPE (quattro)</b>					
1.6	YN	1.6	1980.07 - 1981.08		4264.87D
1.8	DD, DZ	1.8	1981.08 - 1991.07		4264.87D
1.8 GT	DS, DZ, JN, JV, NE, PV, SF	1.8	1982.09 - 1988.10		4264.87D

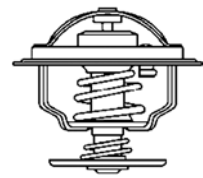

# AUDI

	Engine	Ltr.	Year	Restriction*	Thermostat
1.9	WN	1.9	1980.08 - 1983.07		4116.87D1
2.0	JS ,HP, SK	2.0	1983.09 - 1988.04		4116.87D1
2.0	3A, ABK, AAD	2.0	1989.05 - 1996.12		4264.87D
2.0 16 V	6A. ACE	2.0	1992.01 - 1996.12		4264.87D
2.0 20 V	NM	2.0	1989.08 - 1991.07		4116.87D1
2.1 GT	KE, KL, WE	2.1	1981.01 - 1987.10		4116.87D1
2.2	JT, KV	2.2	1984.10 - 1991.07		4116.87D1
2.2 GT	HY, KV, KX	2.2	1981.07 - 1988.10		4116.87D1
2.3	NG	2.3	1987.01 - 1996.12		4116.87D1
2.3 20V	7A	2.3	1988.11 - 1996.12		4116.87D1
2.6	ABC	2.6	1992.08 - 1996.12		4274.87D
2.8	AAH	2.8	1991.08 - 1996.12		4274.87D
S2	3B, ABY	2.2	1990.09 - 1996.12		4116.87D1
<b>QUATTRO</b>					
2.1 20V Turbo	KW	2.1	1984.05 - 1987.07		4116.87D1
2.1 Turbo	GV, WR, WX	2.1	1980.07 - 1989.07		4116.87D1
2.2 20V Turbo	RR	2.2	1989.08 - 1991.07		4116.87D1
2.2 Turbo	1B, MB	2.2	1987.08 - 1989.07		4116.87D1
<b>Q3 (8U)</b>					
2.0 TDI	CFFA, CFFB, CLJA, CFGD	2.0	2011.09 -		410845.87D
<b>Q5 (8R)</b>					
2.0 TDI	CAHA, CGLA	2.0	2008.11 - 2009.08		410396.82D
<b>TT (quattro)</b>					
1.8 T	AJQ, AMU, APP, APX, ARY, ATC, AUM, AUQ, BAM, BVP, BVR	1.8	1998.01 - 2006.06		3141.87D
2.0 TDI	CBBB	2.0	2008.06 - 2009.07		3472.87D
2.0 TDI	CFGB	2.0	2008.06 -		410845.87D
2.0 TDI	CBBB	2.0	2009.08 -		410845.87D
2.0 TFSI	BWA, BPY	2.0	2006.08 - 2010.06		411187.87D
3.2 V6	BUB	3.2	2006.08 - 2010.06		4455.80D
3.2 VR6	BPF, BHE	3.2	2003.07 - 2006.06		4455.80D
<b>V 8 (quattro)</b>					
3.6	PT	3.6	1988.10 - 1994.02		4274.87D
4.2	ABH	4.2	1991.10 - 1994.02		4274.87D

# Thermostats

## AUTOBIANCHI

Engine

Ltr.

Year

Restriction\*

Thermostat

### A 111

1.4	Fiat BLC.000	1.4	1969.08 - 1972.11		<b>3345.79</b>
-----	--------------	-----	-------------------	--	----------------

### A 112

0.9	A112A 5.000	0.9	1969.10 - 1972.12		<b>3023.87D</b>
-----	-------------	-----	-------------------	--	-----------------

1.0 Abarth	A112A1.000	1.0	1971.09 - 1972.12		<b>3023.87D</b>
------------	------------	-----	-------------------	--	-----------------

### Y 10

1.0	156A2.000, 156A2.246, 156A3.000	1.0	1985.03 - 1995.10		<b>3105.87D</b>
-----	---------------------------------	-----	-------------------	--	-----------------

1.0	156A.000	1.0	1985.03 - 1995.10		<b>4091.82D</b>
-----	----------	-----	-------------------	--	-----------------

1.0 Turbo	156A1.000	1.0	1985.03 - 1995.10		<b>4091.82D</b>
-----------	-----------	-----	-------------------	--	-----------------

1.1	156C.000	1.1	1989.06 - 1995.10		<b>3105.87D</b>
-----	----------	-----	-------------------	--	-----------------

1.1 i.e.	156C.046	1.1	1990.09 - 1995.10		<b>3105.87D</b>
----------	----------	-----	-------------------	--	-----------------

1.3 i.e. GT	146A5.046, 156B.000	1.3	1989.06 - 1995.10	Motor no. →3143798	<b>3378.80</b>
-------------	---------------------	-----	-------------------	--------------------	----------------

1.3 i.e. GT	146A5.046, 156B.000	1.3	1989.07 - 1995.10	Motor no. 3143798 →	<b>3373.80D</b>
-------------	---------------------	-----	-------------------	---------------------	-----------------

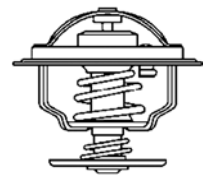

# BMW

	Engine	Ltr.	Year	Restriction*	Thermostat
<b>02 (E6, E10)</b>					
1502	M 10	1.6	1975.01 - 1977.07		3344.80
1600	M 10	1.6	1971.05 - 1973.04		3344.80
1600 Ti	M 10	1.6	1967.09 - 1969.11		3344.80
1600-2	M 10	1.6	1967.12 - 1971.12		3344.80
1602	M 10	1.6	1971.04 - 1975.07		3344.80
1802	M 10	1.8	1971.05 - 1975.07		3344.80
2002	M 10	2.0	1968.02 - 1975.07		3344.80
2002 Ti	M 10	2.0	1968.06 - 1972.04		3344.80
2002 Tii	M 10	2.0	1971.01 - 1975.07		3344.80
2002 Turbo	M10 B20 (Turbo)	2.0	1974.01 - 1975.07		3344.75
<b>1500 / 1600 / 1800 / 2000</b>					
1.6	M 10	1.6	1967.10 - 1969.05		3344.80
1500	M 10	1.5	1962.10 - 1966.07		3344.80
1500	M 10	1.6	1963.09 - 1966.07		3344.80
1600	M 10	1.6	1964.04 - 1968.04		3344.80
1800	0	1.8	1963.08 - 1969.09		3344.80
1800	M 10	1.8	1969.07 - 1971.09		3344.80
1800 Ti	0	1.8	1963.10 - 1968.04		3344.80
2000	M 10	2.0	1968.09 - 1972.07		3344.80
2000	M 10	1.8	1970.01 - 1972.11		3344.80
2000 Ti / Tilux	M 10	2.0	1966.01 - 1972.07		3344.80
2000 Tii	M 10	2.0	1969.12 - 1972.07		3344.80
<b>2000 3.2 Coupe (E9)</b>					
2.5 CS	M 30	2.5	1974.09 - 1976.03		4235.80D
2000 C/CA	M 10	2.0	1965.10 - 1970.06		3344.80
2000 CS	M 10	2.0	1965.10 - 1970.06		3344.80
2800 CS	M 30	2.8	1969.01 - 1971.04		4231.80D
3.0 CS	M 30	3.0	1971.05 - 1976.03		4235.80D
3.0 Csi	M 30	3.0	1971.07 - 1976.03		4235.80D
<b>2500 3.3 (E3)</b>					
2.8 L	M 30	2.8	1975.02 - 1977.04		4231.80D
2500	M 30	2.5	1968.10 - 1977.04		4235.80D
2800	M 30	2.8	1968.10 - 1975.07		4231.80D
3.0 L	M 30	3.0	1975.02 - 1977.04		4235.80D
3.0 S	M 30	3.0	1971.05 - 1977.04		4235.80D
3.0 Si	M 30	3.0	1971.07 - 1977.04		4235.80D
3.2 Li	0	3.2	1975.10 - 1977.04		4231.80D
3.3 L	M 30	3.3	1974.01 - 1976.09		4235.80D
<b>1 Serie (E81, E87)</b>					
116 i	N 45 B16 A	1.6	2003.11 - 2012.09		410793.95D
116 i	N 43 B16 A	1.6	2003.11 - 2012.09		411574.102D ▲
118 i	N 43 B20 A	2.0	2004.07 - 2012.09		411574.102D ▲
118 i	N 46 B20 B	2.0	2004.07 - 2012.09		4337.105D
120 i	N 43	2.0	2003.11 - 2012.09		411574.102D ▲
120 i	N 46	2.0	2003.11 - 2012.09		4337.105D
130 i	N 52	3.0	2005.09 - 2012.09		410086.97D0



# Thermostats

## BMW

	Engine	Ltr.	Year	Restriction*	Thermostat
<b>1 Serie (E82, E88)</b>					
118 i	N 43 B20 A	2.0	2008.03 -		411574.102D ▲
120 i	N 43	2.0	2008.03 -		411574.102D ▲
120 i	N 46	2.0	2008.03 -		4337.105D
125 i	N 52	3.0	2007.10 -		410086.97D0
135 i	N 54	3.0	2007.10 -		410086.97D0
135 i	N 55	3.0	2007.10 -		410766.103D0 ▲
M	N 54	3.0	2011.04 - 2012.06		410086.97D0
<b>3 Serie (E21)</b>					
315	M 10	1.6	1981.03 - 1984.03		3344.80
316	M 10	1.6	1975.08 - 1980.08		3344.80
316	M 10	1.8	1980.09 - 1982.08		3344.80
318	M 10	1.8	1975.08 - 1980.08		3344.80
318 i	M 10	1.8	1979.11 - 1982.08		3344.80
320	M 10	2.0	1975.08 - 1977.08		3344.80
320 /6	M 20	2.0	1977.09 - 1982.08		4232.80D
320 i	M 10	2.0	1975.06 - 1982.08		3344.80
323 i	M 20	2.3	1978.01 - 1982.08		4232.80D
<b>3 Serie (E30)</b>					
315	M 10	1.6	1982.09 - 1991.12		3344.80
316	M 10	1.8	1982.09 - 1990.12		3344.80
316 i	M 10	1.8	1987.08 - 1988.08		3344.80
316 i	M 40	1.6	1987.09 - 1994.06		4236.88D
318 i	M 10	1.8	1982.09 - 1988.08		3344.80
318 i	M 40	1.8	1987.09 - 1994.06		4236.88D
318 i	M 40	1.8	1988.06 - 1992.02		4236.88D
318 is	M 42	1.8	1989.09 - 1991.08		4236.88D
320 i	M 20	2.0	1982.09 - 1985.12		4232.80D
320 i	M 20	2.0	1985.12 - 1991.12		4235.80D
320 i		2.0	1985.12 - 1990.06		4235.80D
320 i	M 20	2.0	1986.04 - 1993.10		4235.80D
323 i	M 20	2.3	1982.09 - 1986.08		4232.80D
324 d	M 21	2.4	1985.09 - 1991.08		4232.80D
324 td	M 21	2.4	1987.09 - 1993.06		4232.80D
325 e 2.7	M 20	2.7	1983.10 - 1988.12		4235.80D
325 i	M 20	2.5	1983.09 - 1993.10		4235.80D
325 i X	M 20	2.5	1986.03 - 1993.10		4235.80D
<b>3 Serie (E36)</b>					
316 g	M 43	1.6	1994.03 - 2000.08		410792.95D
316 i	M 40	1.6	1990.09 - 1993.09		4236.92D
316 i	M 43	1.6	1993.07 - 2000.08		410792.95D
316 i	M 43	1.9	1998.12 - 2000.08		411573.105D ▲
318 i	M 40	1.8	1990.12 - 1993.10		4236.92D
318 i	M 43	1.8	1993.10 - 1999.10		410792.95D
318 is	M 42	1.8	1992.03 - 1998.02		4236.92D
318 tds	M 41	1.7	1995.01 - 2000.08		4237.88D
318 ti	M 42	1.8	1994.11 - 1995.08		4236.92D
320 i	M 52 B, M 50 B	2.0	1990.09 - 1992.09		4235.80D
320 i	M 52 B, M 50 B	2.0	1990.09 - 1999.04	Leitung Drosselklappe zum Zylinderkopf	7129.00D ▲
320 i	M 52 B, M 50 B	2.0	1992.09 - 1995.12		4236.88D

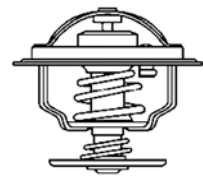

**BMW**

	Engine	Ltr.	Year	Restriction*	Thermostat
320 i	M 52 B, M 50 B	2.0	1995.12 - 1999.10		4236.92D
323 i	M 52	2.5	1995.03 - 1995.12		4236.88D
323 i	M 52	2.5	1995.12 - 1999.10		4236.92D
323 i 2.5	M52 B25 (Vanos)	2.5	1995.03 - 1995.12		4236.88D
323 i 2.5	M52 B25 (Vanos)	2.5	1995.12 - 1998.02		4236.92D
323 ti	M52 B25 (Vanos)	2.5	1997.08 - 2000.08		4236.92D
325 i	M 50	2.5	1990.09 - 1999.04	Leitung Drosselklappe zum Zylinderkopf	7129.00D ▲
325 i	M 50	2.5	1992.03 - 1995.12		4236.88D
325 i	M 50	2.5	1995.12 - 1999.04		4236.92D
325 td	M 51	2.5	1991.09 - 1998.02		4237.80D
325 tds	M 51	2.5	1993.05 - 1999.10		4237.80D
328 i	M 52	2.8	1995.01 - 1995.12		4236.88D
328 i	M 52	2.8	1995.12 - 1999.10		4236.92D
M3 3.0	S 50 B30	3.0	1992.10 - 1995.10		4621.80D
M3 3.0	S 50 B30	3.0	1992.10 - 1995.10	Leitung Drosselklappe zum Zylinderkopf	7129.00D ▲
M3 3.2	S 50 B32	3.2	1995.09 - 1999.04		4621.80D
<b>3 Serie (E46)</b>					
316 i	M 43	1.9	1998.09 - 2005.02		411573.105D ▲
316 i	N 42, N 46	1.8	2002.02 - 2005.02		4337.105D
316 i	N 45	1.6	2002.06 - 2005.02		410793.95D
316 ti	N 42, N 46	1.8	2001.06 - 2005.02		4337.105D
316 ti	N 40, N 45	1.6	2002.06 - 2005.02		410793.95D
318 i	M 43	1.9	1998.02 - 2001.09		411573.105D ▲
318 i	N 42	2.0	2001.09 - 2001.12		410793.95D
318 i	N 46	2.0	2001.09 - 2005.02		4337.105D
318 i	N 42	2.0	2001.12 - 2005.02		4337.105D
318 ti	N 42	2.0	2001.09 - 2001.12		410793.95D
318 ti	N 46	2.0	2001.09 - 2005.02		4337.105D
318 ti	N 42	2.0	2001.12 - 2005.02		4337.105D
320 i	M 52, M 54	2.0	1998.03 - 2005.02		4326.97D
323 i	M 52	2.5	1998.03 - 2000.09		4326.97D
325 i	M 54	2.5	2000.09 - 2005.02		4326.97D
325 ti	M 54	2.5	2001.06 - 2005.02		4326.97D
325 xi	M 54	2.5	2000.09 - 2005.02		4326.97D
328 i	M 52	2.8	1998.02 - 2000.06		4326.97D
330 i	M 54	3.0	2000.06 - 2005.04		4326.97D
330 xi	M 54	3.0	2000.06 - 2005.04		4326.97D
M3 3.2	S 54	3.2	2000.06 -		4621.80D
M3 CSL	S 54	3.2	2003.06 -		4621.80D
<b>3 Serie (E90 / 91 / 92 / 93)</b>					
316 i	N 45	1.6	2006.02 - 2011.12		410793.95D
316 i	N 43	1.6	2007.09 - 2012.05		411574.102D ▲
318 i	N 46	2.0	2007.06 - 2011.12		4337.105D
318 i	N 43	2.0	2007.09 - 2011.12		411574.102D ▲
320 i	N 46	2.0	2005.01 - 2007.08		4337.105D
320 i	N 43	2.0	2005.09 - 2011.12		411574.102D ▲
323 i	N 52	2.5	2005.01 - 2011.12		410086.97D0
325 i	N 51, N 53	3.0	2007.03 - 2011.12		410086.97D0
325 xi	N 52	2.5	2005.01 - 2011.12		410086.97D0
325 xi	N 53	3.0	2007.09 - 2011.12		410086.97D0
328 i	N 52	3.0	2005.07 - 2007.11		410086.97D0

# Thermostate

## BMW

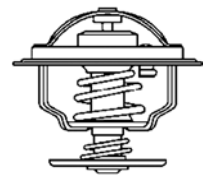
	Engine	Ltr.	Year	Restriction*	Thermostat
330 i	N 52, N 53	3.0	2005.01 - 2011.12		410086.97D0
330 xi	N 52, N 53	3.0	2005.01 - 2011.12		410086.97D0
335 i	N 54	3.0	2006.09 - 2011.12		410086.97D0
335 i	N 55	3.0	2006.09 - 2011.12		410766.103D0 ▲
335 xi	N 54	3.0	2006.09 - 2011.12		410086.97D0
335 xi	N 55	3.0	2006.09 - 2011.12		410766.103D0 ▲
<b>5 Serie (E12)</b>					
518	M 10	1.8	1974.07 - 1981.05		3344.80
518	M 10	2.0	1975.12 - 1977.08		3344.80
518 i	M 10	2.0	1977.08 - 1979.09		3344.80
520	M 10	2.0	1972.08 - 1977.08		3344.80
520 /6	M 20	2.0	1977.09 - 1981.05		4232.80D
520 i	M 10	2.0	1972.08 - 1977.05		3344.80
525	M 30	2.5	1973.08 - 1981.05		4235.80D
528	M 30	2.8	1975.01 - 1977.08		4231.80D
528 i	M 30	2.8	1977.04 - 1981.05		4231.80D
M 3.4	M30 B35 (Motronic,9.3:1)	3.5	1980.06 - 1981.08		4231.80D
<b>5 Serie (E28)</b>					
518	M 10	1.8	1981.06 - 1984.08		3344.80
518 i	M 10	1.8	1981.09 - 1987.12		3344.80
520 i	M20 B20 L-Jetr.	2.0	1981.06 - 1987.12		4232.80D
520 i	M20 B20 K-Jetr.	2.0	1981.06 - 1987.12		4235.80D
524 d	M 21	2.4	1986.03 - 1987.12		4232.80D
524 td	M 21	2.4	1983.09 - 1987.12		4232.80D
525 e	M 20	2.7	1981.09 - 1985.09		4232.80D
525 e	M 20	2.7	1985.09 - 1987.12		4235.80D
525 i	M 20	2.5	1981.06 - 1985.09		4231.80D
525 i	M 20	2.5	1985.09 - 1987.12		4235.80D
528 i	M 30	2.8	1981.06 - 1985.09		4232.80D
528 i	M 30	2.8	1985.09 - 1987.12		4235.80D
535 i, M 535 i	M 30	3.4	1985.01 - 1985.09		4232.80D
535 i, M 535 i	M 30	3.4	1985.09 - 1987.12		4235.80D
<b>5 Serie (E34)</b>					
518 g	M 43	1.8	1995.11 - 1996.06		410792.95D
518 i	M 43	1.8	1989.08 - 1997.01		410792.95D
518 i	M 40	1.8	1993.03 - 1994.09		4236.88D
520 i	M 20	2.0	1988.01 - 1991.08		4235.80D
520 i	M 50	2.0	1991.11 - 1992.09		4236.88D
520 i	M 50	2.0	1991.11 - 1997.01	Leitung Drosselklappe zum Zylinderkopf	7129.00D ▲
520 i	M 50	2.0	1992.09 - 1997.01		4236.92D
520 i 24V	M 50	2.0	1989.09 - 1992.09		4236.88D
520 i 24V	M 50	2.0	1989.09 - 1995.09	Leitung Drosselklappe zum Zylinderkopf	7129.00D ▲
520 i 24V	M 50	2.0	1992.09 - 1995.09		4236.92D
524 td	M 21	2.4	1988.03 - 1995.09		4232.80D
525 i	M 20	2.5	1988.01 - 1991.08		4235.80D
525 i	M 50	2.5	1991.11 - 1992.09		4236.88D
525 i	M 50	2.5	1991.11 - 1997.01	Leitung Drosselklappe zum Zylinderkopf	7129.00D ▲
525 i	M 50	2.5	1992.09 - 1997.01		4236.92D

**BMW**

	Engine	Ltr.	Year	Restriction*	Thermostat
525 i 24V	M 50	2.5	1989.09 - 1995.09		4236.88D
525 i 24V	M 50	2.5	1989.09 - 1995.09	Leitung Drosselklappe zum Zylinderkopf	7129.00D ▲
525 ix	M 50	2.5	1992.02 - 1997.01		4236.88D
525 ix	M 50	2.5	1992.02 - 1997.01	Leitung Drosselklappe zum Zylinderkopf	7129.00D ▲
525 iX 24V	M 52	2.5	1991.10 - 1995.09		4236.88D
525 iX 24V	M 52	2.5	1991.10 - 1995.09	Leitung Drosselklappe zum Zylinderkopf	7129.00D ▲
525 td	M 51	2.5	1993.03 - 1997.01		4237.80D
525 tds	M 51	2.5	1991.09 - 1997.01		4237.80D
530 i	M 30	3.0	1988.01 - 1991.08		4235.80D
530 i V8	M 60	3.0	1992.09 - 1997.01	mit Katalysator	4516.85D
530 i V8	M 60	3.0	1992.09 - 1997.01	ohne Katalysator	4519.95D
535 i	M 30	3.4	1988.01 - 1995.09		4235.80D
540 i	M 60	4.0	1992.09 - 1997.01	mit Katalysator	4516.85D
540 i	M 60	4.0	1992.09 - 1997.01	ohne Katalysator	4519.95D
M 3.6	S 38 B36	3.5	1988.10 - 1992.05	Dichtring	120213
M 3.6	S 38 B36	3.5	1988.10 - 1992.05		4619.80
M 3.8	S 38 B38	3.8	1992.03 - 1997.01	Dichtring	120213
M 3.8	S 38 B38	3.8	1992.03 - 1997.01		4619.80
<b>5 Serie (E39)</b>					
520 i	M 52	2.0	1996.01 - 1998.09		4236.92D
520 i	M 52	2.0	1998.09 - 2004.05		4326.97D
520 i	M 54	2.2	2000.09 - 2004.05		4326.97D
523 i	M 52	2.5	1995.11 - 1998.09		4236.92D
523 i	M 52	2.5	1998.09 - 2000.09		4326.97D
525 i	M 54	2.5	2000.09 - 2004.05		4326.97D
525 td	M 51	2.5	1997.01 - 2003.06		4237.80D
525 tds	M 51	2.5	1996.01 - 2004.05		4237.80D
528 i	M 52	2.8	1995.11 - 1998.08		4236.92D
528 i	M 52	2.8	1998.08 - 2000.09		4326.97D
530 i	M 54	3.0	2000.09 - 2004.05		4326.97D
M 4.9	S 62 B50, S 38 B49	4.9	1998.10 - 2003.06	Dichtring	120213
M 4.9	S 62 B50, S 38 B49	4.9	1998.10 - 2003.06		4619.80
<b>5 Serie (E60)</b>					
520 i	M 54	2.2	2003.07 - 2010.03		4326.97D
520 i	N 43	2.0	2007.09 - 2010.03		411574.102D ▲
523 i	N 52	2.5	2005.07 - 2010.03		410086.97D0
525 i	M 54	2.5	2003.09 - 2010.03		4326.97D
525 i	N 52	2.5	2005.07 - 2010.03		410086.97D0
525 i	N 53	3.0	2007.01 - 2010.03		410086.97D0
525 xi	N 52	2.5	2005.07 - 2010.03		410086.97D0
525 xi	N 53	3.0	2007.01 - 2010.03		410086.97D0
530 i	M 54	3.0	2003.07 - 2010.03		4326.97D
530 i	N 52	3.0	2005.03 - 2010.03		410086.97D0
530 i	N 52	3.0	2007.01 - 2010.03		410086.97D0
530 xi	N 52	3.0	2005.07 - 2010.03		410086.97D0
530 xi	N 52	3.0	2007.01 - 2010.03		410086.97D0
540 i	N 62	4.0	2005.07 - 2010.03		4508.105D
540 i	N 54	3.0	2005.08 - 2010.03		4508.105D
545 i	N 62	4.4	2003.09 - 2010.03		4508.105D
550 i	N 62	4.8	2005.07 - 2010.03		4508.105D

# Thermostate

## BMW

Engine

Ltr.

Year

Restriction\*

Thermostat

### 5 Serie (E61)

520 i	N 43	2.0	2007.09 -		411574.102D ▲
523 i	N 52	2.5	2005.07 -		410086.97D0
525 i	M 54	2.5	2004.06 -		4326.97D
525 i	N 52	2.5	2005.07 -		410086.97D0
525 i	N 53	3.0	2007.01 -		410086.97D0
525 i	N 53	3.0	2008.09 -		410086.97D0
525 xi	N 52	2.5	2005.07 -		410086.97D0
525 xi	N 52	3.0	2007.01 -		410086.97D0
530 i	M 54	3.0	2004.06 -		4326.97D
530 i	N 52	3.0	2005.07 -		410086.97D0
530 i	N 52	3.0	2007.01 -		410086.97D0
530 xi	N 52	3.0	2005.07 -		410086.97D0
545 i	N 63	4.4	2004.06 -		4508.105D
550 i	N 62	4.8	2005.07 -		4508.105D

### 5 Serie (F10 / 11)

535 i	N 55	3.0	2010.03 -		410766.103D0 ▲
550 i	N 63	4.4	2010.03 -		4508.105D

### 5 GRAN TURISMO (F07)

535 i	N 55	3.0	2009.10 -		410766.103D0 ▲
550 i	N 63	4.4	2009.10 -		4508.105D

### 6 Serie (E24)

628 CSi	M 30	2.8	1979.09 - 1985.08		4231.80D
628 CSi	M 30	2.8	1985.08 - 1987.08		4235.80D
630 CS	M 30	3.0	1976.04 - 1979.08		4235.80D
633 CSi	M 30	3.2	1976.04 - 1984.08		4231.80D
635 CSi	M 30	3.4	1978.06 - 1985.07		4231.80D
635 CSi	M 30	3.4	1985.08 - 1990.09		4235.80D

### 6 Serie (E63)

630 i	N 52	3.0	2004.09 -		410086.97D0
645 Ci	N 62	4.4	2004.01 -		4508.105D
650 i	N 62	4.8	2005.07 -		4508.105D

### 6 Serie (E64)

630 i	N 52	3.0	2004.09 -		410086.97D0
645 Ci	N 62	4.4	2004.04 -		4508.105D
650 i	N 62	4.8	2005.07 -		4508.105D

### 6 Cabriolet (F12)

640 i	N 55	3.0	2011.03 -		410766.103D0 ▲
650 i	N 63	4.4	2011.03 -		4508.105D
M	S 63 B44 B	4.4	2012.01 -		4508.105D

### 6 Coupe (F13)

650 i	N 63	4.4	2010.11 -		4508.105D
-------	------	-----	-----------	--	-----------

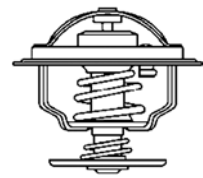

# BMW

	Engine	Ltr.	Year	Restriction*	Thermostat
<b>7 Serie (E23)</b>					
728	M 30	2.8	1977.05 - 1979.08		<b>4231.80D</b>
728 i	M 30	2.8	1978.07 - 1986.08		<b>4235.80D</b>
730	M 30	3.0	1977.05 - 1979.08		<b>4235.80D</b>
733 i	M 30	3.2	1977.05 - 1979.09		<b>4231.80D</b>
735 i	M30 B35 (Motronic,9.3:1)	3.5	1979.09 - 1986.08	9,3:1	<b>4231.80D</b>
735 i	M30 B35 (Motronic,10:1), M30 B35 (Motronic,8:1,Kat.), M30 B34 (346KA)	3.4	1979.09 - 1986.08	8:1 / 10:1	<b>4235.80D</b>
745 i	M30 B32 (Turbo)	3.2	1980.04 - 1983.04		<b>4231.80D</b>
745 i	M 30	3.4	1983.05 - 1986.08		<b>4231.80D</b>
<b>7 Serie (E32)</b>					
730 i	M 30	3.0	1986.12 - 1994.09		<b>4235.80D</b>
730 i V8	M 60	3.0	1992.04 - 1994.09	mit Katalysator	<b>4516.85D</b>
730 i V8	M 60	3.0	1992.04 - 1994.09	ohne Katalysator	<b>4519.95D</b>
735 i	M 30	3.4	1986.09 - 1992.09		<b>4235.80D</b>
740 i V8	M 60	4.0	1992.04 - 1994.09	mit Katalysator	<b>4516.85D</b>
740 i V8	M 60	4.0	1992.04 - 1994.09	ohne Katalysator	<b>4519.95D</b>
750 i V12	M 70	5.0	1987.09 - 1994.09	70° Variante	<b>4516.70D</b>
750 i V12	M 70	5.0	1987.09 - 1994.09	85° Variante	<b>4516.85D</b>
<b>7 Serie (E38)</b>					
725 tds	M 51	2.5	1996.04 - 2001.11		<b>4237.80D</b>
728 i	M 52	2.8	1995.08 - 1998.09		<b>4236.92D</b>
728 i	M 52	2.8	1998.09 - 2001.11		<b>4326.97D</b>
730 i	M 60	3.0	1994.10 - 2001.11	mit Katalysator	<b>4516.85D</b>
730 i	M 60	3.0	1994.10 - 2001.11	ohne Katalysator	<b>4519.95D</b>
740 i	M 60	4.0	1994.10 - 2001.11	mit Katalysator	<b>4516.85D</b>
740 i	M 60	4.0	1994.10 - 2001.11	ohne Katalysator	<b>4519.95D</b>
750 i	M 73	5.4	1994.12 - 2001.11		<b>4594.90D</b>
<b>7 Serie (E65, E66)</b>					
730 i	M 54	3.0	2003.03 -		<b>4326.97D</b>
730 i	N 52	3.0	2005.03 -		<b>410086.97D0</b>
735 i	N 62	3.6	2001.11 -		<b>4508.105D</b>
735 i	N 62	4.0	2005.03 -		<b>4508.105D</b>
740 i	N 62	4.0	2005.07 -		<b>4508.105D</b>
745 i	N 62	4.4	2001.11 -		<b>4508.105D</b>
750 i	N 62	4.8	2005.07 -		<b>4508.105D</b>
760	N 73	6.0	2003.02 - 2005.08		<b>4508.105D</b>
760 i	N 73	6.0	2003.01 -		<b>4508.105D</b>
<b>7 (F01, F02, F03, F04)</b>					
750 i	N 63	4.4	2008.10 -		<b>4508.105D</b>
760 i	N 74	6.0	2009.09 -		<b>4508.105D</b>
ActiveHybrid	N 63	4.4	2010.10 -		<b>4508.105D</b>
<b>8 Serie (E31)</b>					
840 i	M 60	4.0	1993.02 - 1996.02	mit Katalysator	<b>4516.85D</b>
840 i	M 60	4.0	1993.02 - 1996.02	ohne Katalysator	<b>4519.95D</b>
850 Ci	M 73	5.4	1994.09 - 1999.12		<b>4594.90D</b>
850 CSi	M 70	5.6	1993.04 - 1999.12		<b>4516.85D</b>
850 i, Ci	M 70	5.0	1990.04 - 1994.10	70° Variante	<b>4516.70D</b>
850 i, Ci	M 70	5.0	1990.04 - 1994.10	85° Variante	<b>4516.85D</b>

# Thermostats

## BMW

Engine

Ltr.

Year

Restriction\*

Thermostat

### M1

3.5	M 88	3.5	1979.05 - 1983.05		4231.80D
-----	------	-----	-------------------	--	----------

### X1 (E84)

sDrive 18 i	N 46	2.0	2010.01 -		4337.105D
xDrive 25 i	N 52 B30 A	3.0	2009.10 -		410086.97D0
xDrive 28 i	N 52 B30 A	3.0	2009.10 -		410086.97D0

### X3 (E83)

2.0 i	N 46	2.0	2005.07 -		4337.105D
2.5 i	M 54	2.5	2004.01 -		4326.97D
2.5 si	N 52	2.5	2006.09 -		410086.97D0
3.0 i xDrive	M 54	3.0	2004.01 -		4326.97D
3.0 si	N 52	3.0	2006.09 -		410086.97D0
xDrive 20 i	N 46	2.0	2008.09 -		4337.105D
xDrive 25 i	N 52	2.5	2008.09 -		410086.97D0
xDrive 30 i	N 52	3.0	2008.09 -		410086.97D0

### X3 (F25)

xDrive 28 i	N 52	3.0	2011.04 -		410086.97D0
xDrive 35 i	N 55	3.0	2010.09 -		410766.103D0 ▲

### X5 (E53)

3.0 i	M 54	3.0	2000.05 -		4326.97D
4.4 i	N 62	4.4	2003.12 -		4508.105D
4.8 is	N 62	4.8	2004.04 -		4508.105D

### X5 (E70)

3.0 si	N 52	3.0	2007.02 - 2008.09		410087.97D0
4.8 i	N 62	4.8	2007.02 - 2008.09		4508.105D
M	S 63 B44 A	4.4	2009.09 -		4508.105D
xDrive 30 i	N 52	3.0	2008.09 - 2010.03		410087.97D0
xDrive 35 i	N 55	3.0	2010.09 -		410766.103D0 ▲
xDrive 48 i	N 62	4.8	2008.09 -		4508.105D
xDrive 50 i	N 63	4.4	2010.09 -		4508.105D

### X6 (E71, E72)

35 i	N 54	3.0	2008.05 -		410087.97D0
50 i	N 63	4.4	2008.05 -		4508.105D
ActiveHybrid	N 63	4.4	2010.10 -		4508.105D
M	S 63 B44 A	4.4	2009.09 -		4508.105D
xDrive 35 i	N 54	3.0	2008.09 -		410087.97D0
xDrive 35 i	N 55	3.0	2008.09 -		410766.103D0 ▲
xDrive 35 i	N 55	3.0	2012.01 -		410766.103D0 ▲
xDrive 50 i	N 63	4.4	2008.09 -		4508.105D

### Z1

2.5	M 20	2.5	1988.06 - 1991.06		4235.80D
-----	------	-----	-------------------	--	----------

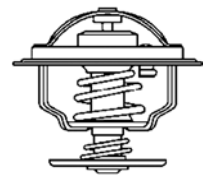
**BMW**

	Engine	Ltr.	Year	Restriction*	Thermostat
<b>Z3 (E36)</b>					
1.8	M 43	1.8	1995.10 - 1998.10		410792.95D
1.9	M 43	1.9	1998.07 - 2003.01		411573.105D ▲
2.0	M 52	2.0	1999.04 - 2003.01		4326.97D
2.2	M 54	2.2	2000.08 - 2003.01		4326.97D
2.8	M 52	2.8	1997.04 - 1998.09		4236.92D
2.8	M 52	2.8	1998.09 - 2000.07		4326.97D
3.0	M 54	3.0	2000.06 - 2003.01		4326.97D
M 3.2	S 50	3.2	1997.03 - 2001.06		4621.80D
M 3.2	S 50	3.2	2000.04 - 2001.04		4621.80D
M 3.2	S 54	3.2	2001.06 - 2003.01		4621.80D
2.8	M 52	2.8	1997.07 - 1998.09		4236.92D
2.8	M 52	2.8	1998.09 - 2000.06		4326.97D
3.0	M 54	3.0	2000.06 - 2003.06		4326.97D
M	S 50	3.2	1998.02 - 2003.06		4621.80D
M	S 54	3.2	2001.06 - 2003.06		4621.80D
<b>Z4 (E85, E86)</b>					
2.0 i	N 46	2.0	2005.04 -		4337.105D
2.2 i	M 54	2.2	2003.10 -		4326.97D
2.5 i	M 54	2.5	2003.02 -		4326.97D
2.5 i	N 52	2.5	2006.01 -		410086.97D0
2.5 si	N 52	2.5	2006.01 -		410086.97D0
3.0 i	M 54	3.0	2003.02 -		4326.97D
3.0 si	N 52	3.0	2006.01 -		410086.97D0
M	S 54	3.2	2006.03 -		4621.80D
<b>Z4 (E89)</b>					
sDrive 23 i	N 52	2.5	2009.05 -		410086.97D0
sDrive 30 i	N 52	3.0	2009.05 -		410086.97D0
sDrive 35 i	N 54	3.0	2009.05 -		410086.97D0
sDrive 35 is	N 54	3.0	2010.09 -		410086.97D0
<b>Z8 (E52)</b>					
4.9	S 62 B50, S 38 B49	4.9	2000.06 - 2003.06	Dichtring	120213
4.9	S 62 B50, S 38 B49	4.9	2000.06 - 2003.06		4619.80



# Thermostate

## CHEVROLET

Engine

Ltr.

Year

Restriction\*

Thermostat

### ASTRA

2.0	X 20 XEV	2.0	1999.03 - 2002.07		<b>4183.92D</b>
2.0 Dti	Y 20 DTH	2.0	2002.08 - 2011.12	Motor no. →17B49754	<b>4198.92D</b>
2.0 Dti	Y 20 DTH	2.0	2002.08 - 2011.12	Motor no. 2(2/5/6/8/B/H) 999999→	<b>4428.92D</b>
2.0 Dti	Y 20 DTH	2.0	2002.09 - 2011.12	Motor no. 17B49755→	<b>4428.92D</b>
2.0 Dti	Y 20 DTH	2.0	2002.09 - 2011.12	Motor no. 2(2/5/6/8/B/H) 999999→	<b>4433.92D</b>

### AVEO (T250, T255)

1.2	F12S3, LQ5	1.2	2006.03 - 2007.12	SOHC	<b>3017.87D2</b>
1.2	LMU, B12D1	1.2	2008.01 -		<b>410183.88D</b>
1.2	F12S3	1.2	2008.10 -		<b>3017.87D2</b>
1.2 LPG	LMU, B12D1	1.2	2008.04 -		<b>410183.88D</b>
1.4	F14D3, L14	1.4	2006.03 - 2007.12		<b>3017.87D2</b>
1.4	A 14 XER, LDT, F14D4	1.4	2008.04 -		<b>3017.87D2</b>
1.4	F14D4	1.4	2008.09 -		<b>3017.87D2</b>
1.6	LXV, A16DMS	1.6	2006.01 -	2-teiliges Aluminiumgehäuse	<b>3017.87D2</b>

### AVEO (T300)

1.6	F16D4	1.6	2011.03 -		<b>411059.105D ▲</b>
1.6	0	1.6	2012.12 -		<b>4431.105D</b>

### CAPTIVA

2.4	Z 24 SED	2.4	2006.06 -		<b>4189.87D</b>
2.4	A 24 XE, LE5	2.4	2011.03 -		<b>411193.82D</b>
2.4 LPG	Z 24 SED	2.4	2007.01 -		<b>4189.87D</b>

### CORSA Kombi

1.6	X 16 XE	1.6	1997.08 - 2002.07		<b>4178.92D</b>
-----	---------	-----	-------------------	--	-----------------

### CORSA Pick-up

1.6		1.6	1994.08 - 2002.07		<b>4178.92D</b>
-----	--	-----	-------------------	--	-----------------

### CRUZE (J300, J305, J308))

1.6		1.6	2012.12 -		<b>4431.105D</b>
1.6 T		1.6	2012.12 -		<b>4431.105D</b>
1.8	2H0, F18D4, LUW	1.8	2009.05 -		<b>4431.105D</b>
1.8 LPG	2H0, F18D4	1.8	2011.06 -		<b>4431.105D</b>

### EPICA (KL1\_)

2.0		2.0	2006.08 -		<b>4183.92D</b>
-----	--	-----	-----------	--	-----------------

### EVANDA

2.0	X 20 SED	2.0	2005.03 -		<b>4189.87D</b>
-----	----------	-----	-----------	--	-----------------

### HHR

2.4		2.4	2007.10 -		<b>411193.82D</b>
-----	--	-----	-----------	--	-------------------

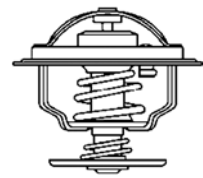

# CHEVROLET

	Engine	Ltr.	Year	Restriction*	Thermostat
<b>KALOS</b>					
1.2	B12S1	1.2	2005.03 -		410183.88D
1.4	F14S3	1.4	2005.03 -		410183.88D
1.4 16V	F14D3	1.4	2005.03 -		3017.87D2
<b>LACETTI (J200)</b>					
1.4		1.4	2005.03 -	2-teiliges Aluminiumgehäuse	3017.87D2
1.4 16V	F14D3	1.4	2005.03 -	2-teiliges Aluminiumgehäuse	3017.87D2
1.6	F16D3	1.6	2005.03 -	2-teiliges Aluminiumgehäuse	3017.87D2
1.8	F18D3	1.8	2005.03 -	2-teiliges Aluminiumgehäuse	3017.87D2
1.8	T18SED	1.8	2005.03 -		4189.87D
<b>MALIBU (V300)</b>					
2.4	LE9	2.4	2012.01 -		411193.82D
<b>MATIZ</b>					
0.8	F8CV	0.8	2005.03 -		410183.82D
0.8 LPG	F8CV	0.8	2005.03 -		410183.82D
1.0	B10S, B10S1	1.0	2005.03 -		410183.82D
<b>NUBIRA</b>					
1.4	F14D3	1.4	2006.01 -		3017.87D2
1.6	F16D3	1.6	2005.03 -		3017.87D2
1.8	T18SED	1.8	2005.03 -		4189.87D
1.8	F18D3	1.8	2005.08 -		3017.87D2
<b>OPTRA</b>					
1.6	F16D3	1.6	2003.08 - 2008.12		3017.87D2
1.8	T18SED	1.8	2003.08 - 2008.12		4189.87D
2.0	X 20 SED	2.0	1999.06 - 2003.07		4189.87D
<b>ORLANDO (J309)</b>					
1.8	2H0, F18D4	1.8	2011.02 -		4431.105D
1.8 LPG	2H0	1.8	2011.06 -		4431.105D
<b>REZZO</b>					
2.0	T20SED	2.0	2005.03 -		4189.87D
<b>SPARK</b>					
0.8	F8CV	0.8	2000.09 - 2004.12		410183.82D
1.0	G 10 CV	1.0	2002.11 - 2004.12		410183.82D
<b>TIGRA</b>					
1.6	C 16 SE	1.6	1997.08 - 1999.12		4178.92D
<b>VECTRA</b>					
2.2	Z 22 YH	2.2	2005.01 - 2006.07		411193.82D

# Thermostate

## CHEVROLET

Engine

Ltr.

Year

Restriction\*

Thermostat

### VIVANT

1.6	A16DMS	1.6	2001.08 -		<b>3017.92D2</b>
2.0	X 20 SED	2.0	2000.08 -		<b>4189.87D</b>
2.0	T20SED	2.0	2005.01 -		<b>4189.87D</b>

### ZAFIRA

2.2		2.2	2001.04 - 2004.07		<b>411193.82D</b>
2.2	Z 22 YH	2.2	2005.07 -		<b>411193.82D</b>

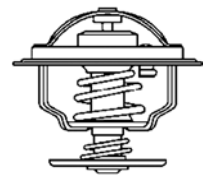

# CHRYSLER

	Engine	Ltr.	Year	Restriction*	Thermostat
<b>CROSSFIRE</b>					
3.2	EGX	3.2	2003.07 - 2007.12		4281.87D
<b>NEON</b>					
1.6	EJD	1.6	2001.11 - 2006.12		410262.91D
1.8 16V	EBD	1.8	1997.09 - 1999.08		410262.91D
2.0 16V	420H, 420T, ECB, ECC, ECH	2.0	1994.05 - 2006.12		410262.91D
<b>PT CRUISER</b>					
1.6	EJD	1.6	2001.11 - 2010.12		410262.91D
2.0	ECC	2.0	2000.06 - 2010.12		410262.91D
2.4	EDZ	2.4	2000.06 - 2010.12		410262.91D
2.4 GT	EDV	2.4	2004.03 - 2008.03		410262.91D
GT 2.4	EDV	2.4	2003.08 - 2010.12		410262.91D
<b>SEBRING</b>					
2.0	ECC	2.0	2001.04 - 2007.06		410262.91D
2.4	EDZ	2.4	2001.04 - 2007.06		410262.91D
<b>STRATUS</b>					
2.0 16V	ECB	2.0	1995.12 -		410262.91D
2.0 LE	420X, C00	2.0	1996.06 - 2001.04		410262.91D
2.4 16 V	EDZ	2.4	1995.12 - 2001.04		410262.91D
2.5	625H	2.5	1996.04 - 2001.04		410180.82D
2.5 V6	EEB, H00	2.5	1995.12 - 2001.04		410180.82D
<b>VOYAGER III (GS)</b>					
2.5 TD	425 CLIRS, X, ENC	2.5	1995.01 - 2001.03		4158.80D
<b>300 C (LX)</b>					
3.0 CRD	M664	3.0	2005.09 - 2012.11		4630.87D ▲

# CITROËN

Engine

Ltr.

Year

Restriction\*

Thermostat

## AX

1.3 Sport	M4A	1.3	1987.04 - 1988.12		3136.88D50
1.4	K2A	1.4	1986.09 - 1992.07		3136.88D50
1.4 D	K9A (TUD3)	1.4	1991.06 - 1992.07		3136.88D50
1.4 GTi	KFY (TU3FJ2), KFZ (TU3FJ2)	1.4	1991.06 - 1996.12		3136.88D50
10	C1A, CDY (TU9M), CDZ (TU9M)	1.0	1986.07 - 1998.12		3136.88D50
10 E	C3A	1.0	1986.12 - 1988.12		3136.82D50
11	H1A, H1B, HAZ (TU1CP), HDZ (TU1M)	1.1	1986.12 - 1994.04		3136.88D50
14	K1F, K2B, K2A, KAY (TU3CP), KDY (TU3FM), KDZ (TU3M, Z), KDX (TU3M, Z), KDY (TU3M)	1.4	1987.01 - 1997.04		3136.88D50
14 D	K9A (TUD3), K9Y (TUD3Y)	1.4	1988.09 - 1992.06		4821.89D
15 D	VJY (TUD5), VJZ (TUD5)	1.5	1994.08 - 1997.12		4821.89D

## BERLINGO

1.1 i	HDZ (TU1M)	1.1	1996.07 -		3136.88D50
1.1 i	HFX (TU1JP)	1.1	1996.07 -		410184.89D
1.4	KFW (TU3JP)	1.4	2002.11 - 2005.10		3463.89D
1.4 bivalent	KFW (TU3JP)	1.4	2002.11 -		3463.89D
1.4 GNC	KFW (TU3JP)	1.4	2002.11 -		3463.89D
1.4 Hybrid	KFW (TU3JP)	1.4	2005.05 -		3463.89D
1.4 i	KFX (TU3JP), KFW (TU3JP)	1.4	1996.07 -	Organisations no. →O 08210	3136.88D50
1.4 i	KFX (TU3JP), KFW (TU3JP)	1.4	1996.08 -	Organisations no. O 08211→	410184.89D
1.6	NFU (TU5JP4), NFR (TU5JP4B)	1.6	2008.04 -		410705.89D
1.6 16V	NFU (TU5JP4)	1.6	2000.10 - 2002.10		410184.89D
1.6 16V	NFU (TU5JP4)	1.6	2002.11 - 2005.08	Organisations no. →10527	3463.89D
1.6 16V	NFU (TU5JP4)	1.6	2005.08 -	Organisations no. 10528→	410705.89D
1.8 D	A9A (XUD7)	1.8	1996.07 - 1999.10		4446.83D
1.8 i	LFX (XU7JB)	1.8	1997.04 - 2002.10		3136.82D50
1.9 D	DW8, DW8B, XUD9A	1.9	1996.07 -		4446.83D
1.9 D 70	DW8, DW8B	1.9	1998.07 -		4446.83D
2.0 Hdi	RHY (DW10TD)	2.0	2002.11 - 2005.10		4446.83D
2.0 HDI 90	RHY (DW10TD)	2.0	1999.12 -		4446.83D

## BX

1.6	B6E, B6D	1.6	1987.01 - 1992.01	82° Variante	3136.82D50
1.6	B6E, B6D	1.6	1987.01 - 1992.01	88° Variante	3136.88D50
1.9 DT TXD		1.9	1992.02 - 1994.12		4446.83D
1.9 GTi		1.9	1990.01 - 1994.06	82° Variante	3136.82D50
1.9 GTi		1.9	1990.01 - 1994.06	88° Variante	3136.88D50
1.9 RD		1.9	1987.01 - 1992.01	Organisations no. →O 5637	4147.80D
1.9 RD		1.9	1987.02 - 1992.01	Organisations no. O 5638→	4446.83D
11	H1A	1.1	1986.10 - 1992.06	82° Variante	3136.82D50
11	H1A	1.1	1986.10 - 1992.06	88° Variante	3136.88D50
11	HDZ (TU1M)	1.1	1988.10 - 1992.06	82° Variante	3136.82D50
11	HDZ (TU1M)	1.1	1988.10 - 1992.06	88° Variante	3136.88D50
14	150C	1.4	1986.01 - 1993.02	82° Variante	3136.82D50
14	150C	1.4	1986.01 - 1993.02	88° Variante	3136.88D50
14	K1H (TU3A), KDZ (TU3M, Z), KDY (TU3M)	1.4	1989.01 - 1989.12	82° Variante	3136.82D50

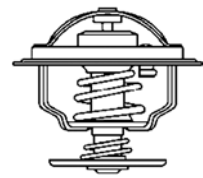

# CITROËN

	Engine	Ltr.	Year	Restriction*	Thermostat
14	K1H (TU3A), KDZ (TU3M, Z), KDY (TU3M)	1.4	1989.01 - 1993.02	88° Variante	<b>3136.88D50</b>
14 E	150	1.4	1982.10 - 1993.03	82° Variante	<b>3136.82D50</b>
14 E	150	1.4	1982.10 - 1993.03	88° Variante	<b>3136.88D50</b>
15	B1E (XU51C)	1.5	1987.10 - 1992.05	82° Variante	<b>3136.82D50</b>
15	B1E (XU51C)	1.5	1987.10 - 1992.05	88° Variante	<b>3136.88D50</b>
16	171, 180, XU5	1.6	1982.10 - 1994.12	82° Variante	<b>3136.82D50</b>
16	171, 180, XU5	1.6	1982.10 - 1994.12	88° Variante	<b>3136.88D50</b>
16 E	BDY (XU5M), BDZ (XU5M)	1.6	1989.05 - 1993.02	82° Variante	<b>3136.82D50</b>
16 E	BDY (XU5M), BDZ (XU5M)	1.6	1989.05 - 1993.02	88° Variante	<b>3136.88D50</b>
18 D	XUD7	1.8	1985.10 - 1993.09	Organisations no. →O 5637	<b>4147.80D</b>
18 D	XUD7	1.8	1985.11 - 1993.09	Organisations no. O 5638→	<b>4446.83D</b>
19	159A, XU9	1.9	1986.07 - 1994.12	82° Variante	<b>3136.82D50</b>
19	159A, XU9	1.9	1986.07 - 1994.12	88° Variante	<b>3136.88D50</b>
19 D	XUD9	1.9	1983.09 - 1994.12	Organisations no. →O 5637	<b>4147.80D</b>
19 D	XUD9	1.9	1983.10 - 1994.12	Organisations no. O 5638→	<b>4446.83D</b>
19 E	D2F, XU9M	1.9	1988.06 - 1993.02		<b>3136.82D50</b>
19 GTi	D6A (XU9J2), DKZ (XU9JA)	1.9	1986.07 - 1993.02	82° Variante	<b>3136.82D50</b>
19 GTi	D6A (XU9J2), DKZ (XU9JA)	1.9	1986.07 - 1993.02	88° Variante	<b>3136.88D50</b>
19 GTi 16V	D6C (XU9J4), DFW (XU9J4)	1.9	1987.09 - 1988.12		<b>3136.82D50</b>
TRD Turbo	AJZ (XUD7TE), A8A (XUD7TE)	1.8	1988.03 - 1994.12	Organisations no. →O 5637	<b>4147.80D</b>
TRD Turbo	AJZ (XUD7TE), A8A (XUD7TE)	1.8	1988.04 - 1994.12	Organisations no. O 5638→	<b>4446.83D</b>
<b>C 2</b>					
1.1	HFX (TU1JP)	1.1	2003.09 -		<b>410184.89D</b>
1.4	KFV (TU3JP)	1.4	2003.09 -		<b>410184.89D</b>
1.4 16V	KFU (ET3J4)	1.4	2006.06 -		<b>410705.89D</b>
1.6	NFU (TU5JP4)	1.6	2003.09 -	Organisations no. →10401	<b>410184.89D</b>
1.6	NFU (TU5JP4)	1.6	2003.10 -	Organisations no. 10402→	<b>410705.89D</b>
1.6 VTS	NFS (TU5JP4S)	1.6 i	2005.01 -	Organisations no. →10401	<b>410184.89D</b>
1.6 VTS	NFS (TU5JP4S)	1.6 i	2005.02 -	Organisations no. 10402→	<b>410705.89D</b>
<b>C 3</b>					
1.1 i	HFX (TU1JP)	1.1	2002.02 -		<b>410184.89D</b>
1.4	KFV (TU3JP)	1.4	2003.05 -		<b>410184.89D</b>
1.4 16V	KFU (ET3J4)	1.4	2003.11 -	Organisations no. →10373	<b>410184.89D</b>
1.4 16V	KFU (ET3J4)	1.4	2003.12 -	Organisations no. 10374→	<b>410705.89D</b>
1.4 Hybrid	KFV (TU3JP)	1.4	2005.05 -		<b>410184.89D</b>
1.4 i	KFV (TU3JP), KFV (TU3A)	1.4	2002.02 -		<b>410184.89D</b>
1.4 i Bivalent	KFV (TU3JP)	1.4	2002.02 -		<b>410184.89D</b>
1.6	NFU (TU5JP4)	1.6	2003.05 -	Organisations no. →10401	<b>410705.89D</b>
1.6	NFU (TU5JP4)	1.6	2003.06 -	Organisations no. 10402→	<b>410184.89D</b>
1.6 16V	NFU (TU5JP4)	1.6	2002.02 -	Organisations no. →10401	<b>410184.89D</b>
1.6 16V	NFU (TU5JP4)	1.6	2002.03 -	Organisations no. 10402→	<b>410705.89D</b>

# CITROËN

	Engine	Ltr.	Year	Restriction*	Thermostat
<b>C 4</b>					
1.4 16V	KFU (ET3J4)	1.4	2004.11 -	Organisations no. →10436	<b>3463.89D</b>
1.4 16V	KFU (ET3J4)	1.4	2004.12 -	Organisations no. 10437→	<b>410705.89D</b>
1.6 16V	NFU (TU5JP4)	1.6	2004.11 -	Organisations no. →10436	<b>3463.89D</b>
1.6 16V	NFU (TU5JP4)	1.6	2004.12 -	Organisations no. 10437→	<b>410705.89D</b>
1.6 16V Bio-Flex	NFU (TU5JP4)	1.6	2007.07 -	Organisations no. →10436	<b>3463.89D</b>
1.6 16V Bio-Flex	NFU (TU5JP4)	1.6	2007.08 -	Organisations no. 10437→	<b>410705.89D</b>
1.6 Flex		1.6	2009.02 -		<b>410705.89D</b>
1.8 i 16V	6FY (EW7A)	1.8	2006.10 -	Organisations no. 11074→	<b>3483.89D</b>
2.0 16V	RFN (EW10J4), RFK (EW10J4S)	2.0	2004.11 -		<b>3483.89D</b>
2.0 i 16V	RFJ (EW10A)	2.0	2006.10 -	Organisations no. 11074→	<b>3483.89D</b>
<b>C5 I (DC, DE)</b>					
1.8 16V	6FZ (EW7J4)	1.8	2001.03 - 2004.08		<b>3483.89D</b>
2.0 16V	RFN (EW10J4)	2.0	2001.03 - 2004.08		<b>3483.89D</b>
2.0 16V HPi	RLZ (EW10D)	2.0	2001.03 - 2004.08		<b>3483.89D</b>
2.0 HDi	DW10TD, DW10ATED,	2.0	2001.03 - 2004.08		<b>4446.83D</b>
2.2 HDi	4HX (DW12TED4, FAP)	2.2	2001.03 - 2004.08		<b>4446.83D</b>
<b>C 5 II (RC, RE)</b>					
1.8 16V	6FY (EW7A), 6FZ (EW7J4)	1.8	2004.09 -	Organisations no. 10921→	<b>3483.89D</b>
2.0 16V	RFJ (EW10A)	2.0	2004.09 -		<b>3483.89D</b>
2.2 HDi	4HX (DW12TED4, FAP)	2.2	2004.09 -		<b>4446.83D</b>
<b>C 5 III (RD, TD)</b>					
1.8 16V	6FY (EW7A)	1.8	2008.02 -		<b>3483.89D</b>
2.0 16V	RFJ (EW10A)	2.0	2008.02 -		<b>3483.89D</b>
2.0 16V BioFlex	RFJ (EW10A)	2.0	2008.02 -		<b>3483.89D</b>
<b>C 8</b>					
2.0	RFN (EW10J4)	2.0	2002.07 -		<b>3483.89D</b>
2.0 16V	RFJ (EW10A)	2.0	2005.09 -		<b>3483.89D</b>
2.0 HDi	RHT (DW10ATED4), RHM (DW10ATED4), RHW (DW10ATED4)	2.0	2002.07 -		<b>4446.83D</b>
2.2	3FZ (EW12J4)	2.2	2002.07 -		<b>3483.89D</b>
2.2 HDi	4HW (DW12TED4)	2.2	2002.07 -		<b>4446.83D</b>
<b>C 15</b>					
1.0	XV8, TU9	1.0	1984.10 - 1997.12	Organisations no. →O 4195	<b>3136.82D50</b>
1.0	XV8, TU9	1.0	1984.11 - 1997.12	Organisations no. O 4196→	<b>3136.88D50</b>
1.0 E	TU9K	1.0	1992.11 - 1996.07	Organisations no. →O 4195	<b>3136.82D50</b>
1.0 E	TU9K	1.0	1992.12 - 1996.07	Organisations no. O 4196→	<b>3136.88D50</b>
1.1	109K, E1A, H1A	1.1	1984.10 - 1996.12	Organisations no. →O 4195	<b>3136.82D50</b>

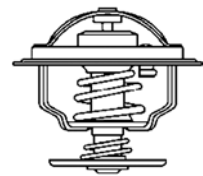

# CITROËN

	Engine	Ltr.	Year	Restriction*	Thermostat
1.1	109K, E1A, H1A	1.1	1984.11 - 1996.12	Organisations no. O 4196→	<b>3136.88D50</b>
1.1 i	HDZ (TU1M)	1.1	1988.07 - 1996.12		<b>3136.88D50</b>
1.4	K1H (TU3A)	1.4	1987.07 - 1996.12	Organisations no. →O 4195	<b>3136.82D50</b>
1.4	K1H (TU3A)	1.4	1987.08 - 1996.12	Organisations no. O 4196→	<b>3136.88D50</b>
1.4 E	150D (XY7)	1.4	1987.05 - 1996.12	Organisations no. →O 4195	<b>3136.82D50</b>
1.4 E	150D (XY7)	1.4	1987.06 - 1996.12	Organisations no. O 4196→	<b>3136.88D50</b>
1.4 E	K3A	1.4	1987.07 - 1996.12		<b>3136.88D50</b>
1.4 i	KDY (TU3FM), KDY (TU3M)	1.4	1991.05 - 1996.12		<b>3136.88D50</b>
1.8 D	161A (XUD7)	1.8	1986.07 - 2000.12	Organisations no. →O 5653	<b>4147.80D</b>
1.8 D	161A (XUD7)	1.8	1986.08 - 2000.12	Organisations no. O 5654→	<b>4446.83D</b>
1.9 D	WJX (DW8B)	1.9	2000.12 - 2005.12		<b>4446.83D</b>
<b>C 25</b>					
1.8 E	169 (XM7T)	1.8	1987.07 - 1994.02		<b>3061.82</b>
1.9 DT		1.9	1991.10 - 1994.01		<b>3431.80D</b>
1.9 TD	M705	1.9	1992.04 - 1994.02		<b>3431.80D</b>
2.0	170C (XN1T)	2.0	1987.01 - 1994.03		<b>3061.82</b>
2.0 E	170B (XN1T), 170A (XN1T)	2.0	1981.09 - 1994.03		<b>3061.82</b>
2.5 D	CRD93L (U25-661)	2.5	1985.10 - 1994.02		<b>3033.84D ▲</b>
2.5 D Turbo	CRD93LS (U25-673)	2.5	1987.08 - 1994.02		<b>3033.84D ▲</b>
<b>C-ELYSEE</b>					
1.6 VTi 115	NFP (EC5)	1.6	2012.11 -		<b>410705.89D</b>
<b>CX</b>					
20	829 A5	2.0	1985.08 - 1986.08		<b>3033.84D ▲</b>
20 RE	829 A5	2.0	1985.08 - 1992.12		<b>3033.84D ▲</b>
2000	M20-616	2.0	1974.09 - 1979.05		<b>3033.84D ▲</b>
2000	829 A5	2.0	1979.06 - 1985.08		<b>3033.84D ▲</b>
22 TRS	J6T A500	2.2	1985.07 - 1992.12		<b>3033.84D ▲</b>
2200	M22-617	2.2	1974.09 - 1976.07		<b>3033.84D ▲</b>
2200	J6T A500	2.2	1981.06 - 1985.08		<b>3033.84D ▲</b>
2400	M23-623, M23-639	2.4	1976.08 - 1982.05		<b>3033.84D ▲</b>
2400 GTi	M23-622	2.4	1977.06 - 1983.06		<b>3033.84D ▲</b>
25 D	M25-660	2.5	1985.08 - 1992.12		<b>3033.84D ▲</b>
25 D Turbo	M25-648, M25-669	2.5	1983.04 - 1992.12		<b>3033.84D ▲</b>
25 GTi	M25-668	2.5	1986.05 - 1992.12		<b>3033.84D ▲</b>
25 GTi Turbo 2	M25-662, M25-667	2.5	1984.06 - 1992.12		<b>3033.84D ▲</b>
25 i	M25-668	2.5	1986.05 - 1992.12		<b>3033.84D ▲</b>
25 TRI	M25-659	2.5	1983.07 - 1992.12		<b>3033.84D ▲</b>
2500 D	M25-629	2.5	1978.02 - 1985.08		<b>3033.84D ▲</b>
2500 D Turbo	M25-648	2.5	1983.04 - 1986.12		<b>3033.84D ▲</b>
<b>EVASION (22, U6)</b>					
1.8		1.8	1996.02 - 1996.12	Organisations no. →O 07195	<b>3136.88D50</b>
1.8		1.8	1996.03 - 1996.12	Organisations no. O 07196→	<b>3136.82D50</b>
1.8	LFZ (XU7JP)	1.8	1997.05 - 2002.07		<b>3136.88D50</b>
1.9 TD	XUD9TF	1.9	1994.11 - 2002.07		<b>4446.83D</b>



# CITROËN

	Engine	Ltr.	Year	Restriction*	Thermostat
2.0	RFU (XU10J2, C)	2.0	1994.06 - 2002.07	Organisations no. →O 07195	<b>3136.88D50</b>
2.0	RFU (XU10J2, C)	2.0	1994.07 - 2002.07	Organisations no. O 07196→	<b>3136.82D50</b>
2.0 16V	RFV (XU10J4R)	2.0	1998.05 - 2000.04		<b>4450.83D</b>
2.0 16V	RFN (EW10J4)	2.0	2000.05 - 2002.07		<b>3463.89D</b>
2.0 HDI	RHZ (DW10ATED)	2.0	1999.08 - 2002.07		<b>4446.83D</b>
2.0 HDI 16V	RHW (DW10ATED4)	2.0	1999.09 - 2002.07		<b>4446.83D</b>
2.0 Turbo C.T.	RGX (XU10J2TE)	2.0	1994.06 - 2002.07	Organisations no. →O 07195	<b>3136.88D50</b>
2.0 Turbo C.T.	RGX (XU10J2TE)	2.0	1994.07 - 2002.07	Organisations no. O 07196→	<b>3136.82D50</b>
2.1 TD	P8C (XUD11BTE)	2.1	1996.05 - 2002.07		<b>4446.83D</b>
<b>JUMPER (230)</b>					
1.9 D	XUD9A, U	1.9	1994.02 - 2002.04		<b>4446.83D</b>
1.9 TD	DHX (XUD9TF, BTF)	1.9	1994.02 - 2002.04		<b>4450.83D</b>
2.0	RFW (XU10J2U)	2.0	1994.02 - 2002.04	Organisations no. →O 07195	<b>3136.88D50</b>
2.0	RFW (XU10J2U)	2.0	1994.03 - 2002.04	Organisations no. O 07196→	<b>3136.82D50</b>
2.0 HDI	RHV (DW10UTD)	2.0	2001.11 - 2002.04		<b>4446.83D</b>
2.5 D	T9A (DJ5)	2.5	1994.03 - 2002.04	Einbauseite Zylinderkopf	<b>410058.84D</b>
2.5 TD	T8A (DJ5T)	2.5	1994.03 - 2002.04	Einbauseite Zylinderkopf	<b>410058.84D</b>
2.5 TDi	THX (DJ5TED)	2.5	1996.12 - 2002.04	Einbauseite Zylinderkopf	<b>410058.84D</b>
2.8 HDi	8140.43S	2.8	2000.09 - 2002.04	82° Variante	<b>4174.82D</b>
2.8 HDi	8140.43S	2.8	2000.09 - 2002.04	88° Variante	<b>4174.88D ▲</b>
<b>JUMPER (244)</b>					
2.0	XU10J2	2.0	2002.04 -		<b>3136.82D50</b>
2.0 bivalent	XU10J2	2.0	2003.02 -		<b>3136.82D50</b>
2.0 HDi	RHV (DW10TD), RHV (DW10UTD)	2.0	2002.04 -		<b>4446.83D</b>
2.0 i	RFH (EW10A)	2.0	2007.01 -		<b>3483.89D</b>
2.2 HDi	4HY (DW12UTED)	2.2	2002.02 - 2006.06		<b>4446.83D</b>
2.2 HDi 16V	4HY (DW12UTED)	2.2	2002.04 -		<b>4446.83D</b>
2.8 HDi	8140.43N, 8140.43S	2.8	2002.04 -	82° Variante	<b>4174.82D</b>
2.8 HDi	8140.43N, 8140.43S	2.8	2002.04 -	88° Variante	<b>4174.88D ▲</b>
<b>JUMPER</b>					
2.2 HDi 100	4HV (P22DTE)	2.2	2006.04 -		<b>3497.88D</b>
2.2 HDi 110		2.2	2011.07 -		<b>3497.88D</b>
2.2 HDi 120	4HU (P22DTE)	2.2	2006.04 -		<b>3497.88D</b>
2.2 HDi 130		2.2	2011.07 -		<b>3497.88D</b>
2.2 HDi 150		2.2	2011.07 -		<b>3497.88D</b>
3.0 HDi 145	F1CE3481N	3.0	2010.07 -		<b>410075.79D ▲</b>
3.0 HDi 155	F1CE0481D (F30DT)	3.0	2010.07 -		<b>410075.79D ▲</b>
3.0 HDi 160	F1CE0481D (F30DT)	3.0	2006.09 -		<b>410075.79D ▲</b>
3.0 HDi 180		3.0	2011.07 -		<b>410075.79D ▲</b>
<b>JUMPY</b>					
1.9 D	D9B (XUD9A, U)	1.9	1995.10 - 1998.08		<b>4446.83D</b>
1.9 D 70	DW8, DW8B	1.9	1998.04 -		<b>4446.83D</b>
1.9 DT		1.9	1995.10 - 2000.08		<b>4446.83D</b>
1.9 TD	D8B (XUD9TF), DHX (XUD9TF, BTF)	1.9	1995.10 -		<b>4446.83D</b>

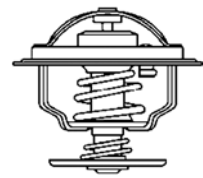

# CITROËN

	Engine	Ltr.	Year	Restriction*	Thermostat
2.0	RFN (EW10J4)	2.0	2000.04 - 2006.12		<b>3463.89D</b>
2.0 HDi 110	RHZ (DW10ATED)	2.0	2000.03 -		<b>4446.83D</b>
2.0 HDi 95	RHX (DW10BTED)	2.0	1999.10 -		<b>4446.83D</b>
2.0 i	RFH (EW10A)	2.0	2007.01 -		<b>3483.89D</b>
2.0 i 16V		2.0	2000.03 -		<b>3463.89D</b>
<b>LNA</b>					
0.6	V06 644	0.6	1982.07 - 1985.04		<b>3136.82D50</b>
1.0	108C	1.0	1984.07 - 1986.10		<b>3136.82D50</b>
1.1	109, 5E	1.1	1982.07 - 1985.04		<b>3136.82D50</b>
<b>NEMO</b>					
1.4	KFT (TU3A), KFV (TU3A)	1.4	2008.02 -		<b>410184.89D</b>
<b>SAXO</b>					
1.0 X	CDZ (TU9M)	1.0	1996.05 - 2003.06		<b>3136.88D50</b>
1.1 X, SX	HDZ (TU1M)	1.1	1996.05 - 2003.09		<b>3136.88D50</b>
1.1 X, SX	HFX (TU1JP)	1.1	1996.05 - 2003.09		<b>410184.89D</b>
1.4 VTS	KFX (TU3JP), KFW (TU3JP)	1.4	1996.05 - 2003.06		<b>3136.88D50</b>
1.5 D	VJZ (TUD5)	1.5	1996.09 - 2004.04		<b>4821.89D</b>
1.6	NFZ (TU5JP)	1.6	1996.02 - 2003.06	66 kW, Organisations no. →08210	<b>3136.88D50</b>
1.6	NFX (TU5JP4)	1.6	1996.02 - 2004.04	88 kW	<b>3136.88D50</b>
1.6	NFZ (TU5JP)	1.6	1996.03 - 2003.06	66 kW, Organisations no. 08211→	<b>410184.89D</b>
1.6	NFT	1.6	2001.02 - 2004.04	Automatikgetriebe, 74 kW	<b>3463.89D</b>
1.6	NFT	1.6	2001.02 - 2004.04	Schaltgetriebe, 74 kW	<b>410184.89D</b>
1.6 VTL, VTR, VTS	NFZ (TU5JP), NFX (TU5JP4)	1.6 i	1996.05 - 2003.09		<b>3136.88D50</b>
<b>VISA</b>					
1.0	XV8	1.0	1984.09 - 1988.06		<b>3136.82D50</b>
11	109, 5, 109, 5F, 109K	1.1	1978.09 - 1991.03		<b>3136.82D50</b>
14	150D (XY7)	1.4	1984.07 - 1991.03		<b>3136.82D50</b>
14 GT	150B (XY8), 180A (XU5J), B6D	1.4	1982.03 - 1991.03		<b>3136.82D50</b>
16 GTI		1.6	1985.01 - 1986.06		<b>3136.82D50</b>
17 D	161A (XUD7)	1.7	1984.04 - 1991.03		<b>4147.80D</b>
II Super X	129, 5	1.2	1980.07 - 1982.06		<b>3136.82D50</b>
<b>XANTIA (X1)</b>					
1.6 i	BFZ (XU5JP)	1.6 i	1980.07 - 1998.01	82° Variante	<b>3136.82D50</b>
1.6 i	BFZ (XU5JP)	1.6 i	1980.07 - 1998.01	88° Variante	<b>3136.88D50</b>
1.8 i	LFX (XU7JB), LFZ (XU7JP)	1.8	1993.03 - 1998.01	82° Variante	<b>3136.82D50</b>
1.8 i	LFX (XU7JB), LFZ (XU7JP)	1.8	1993.03 - 1998.01	88° Variante	<b>3136.88D50</b>
1.8 i 16V	LFY (XU7JP4)	1.8	1995.06 - 1998.01		<b>4450.83D</b>
1.9 D	D9B (XUD9A, L) DJZ (XUD9Y)	1.9	1994.06 - 1998.01		<b>4446.83D</b>
1.9 SD	DHW (XUD9SD)	1.9	1996.02 - 1998.01		<b>4446.83D</b>
1.9 Turbo D	DHX (XUD9TF, BTF), DHY (XUD9TE, Y), D8B (XUD9TF)	1.9	1994.10 - 1998.01		<b>4450.83D</b>
2.0 i	RFX (XU10J2C)	2.0	1993.03 - 1998.01	82° Variante	<b>3136.82D50</b>
2.0 i	RFX (XU10J2C)	2.0	1993.03 - 1998.01	88° Variante	<b>3136.88D50</b>
2.0 i 16V	RFT (XU10J4, Z), RFV (XU10J4R), RFY (XU10J4, Z)	2.0	1993.03 - 1998.01		<b>4450.89D</b>
2.0 Turbo	RGX (XU10J2TE)	2.0	1995.06 - 1998.01		<b>3136.82D50</b>

# CITROËN

	Engine	Ltr.	Year	Restriction*	Thermostat
2.1 Turbo D 12V	P8C (XUD11BTE)	2.1	1995.06 - 1998.01	Organisations no. →O 7189	<b>4447.80D</b>
2.1 Turbo D 12V	P8C (XUD11BTE)	2.1	1995.07 - 1998.01	Organisations no. O 7190→	<b>4447.85D</b>
<b>XANTIA (X2)</b>					
1.8 i	LFX (XU7JB)	1.8	1998.01 - 2003.04		<b>3136.82D50</b>
1.8 i 16V	LFY (XU7JP4)	1.8	1998.01 - 2003.04		<b>4450.83D</b>
1.9 SD	DHW (XUD9SD)	1.9	1998.01 - 2003.04		<b>4450.83D</b>
1.9 Turbo D	DHX (XUD9TF, BTF), D8B (XUD9TF), DHY (XUD9TE, Y)	1.9	1998.01 - 2003.04		<b>4450.83D</b>
2.0 HDI 109	RHZ (DW10ATED)	2.0	1999.02 - 2003.04		<b>4446.83D</b>
2.0 HDI 90	RHY (DW10TD)	2.0	1999.03 - 2003.04		<b>4446.83D</b>
2.0 i	RFX (XU10J2C)	2.0	1998.01 - 2003.04	82° Variante	<b>3136.82D50</b>
2.0 i	RFX (XU10J2C)	2.0	1998.01 - 2003.04	88° Variante	<b>3136.88D50</b>
2.0 i 16V	RFV (XU10J4R)	2.0	1998.01 - 2003.04		<b>4450.83D</b>
2.0 Turbo	RGX (XU10J2TE)	2.0	1998.01 - 2003.04		<b>3136.82D50</b>
2.1 Turbo D 12V	P8C (XUD11BTE)	2.1	1998.01 - 1999.02		<b>4447.85D</b>
<b>XM (Y3)</b>					
2.0		2.0	1989.05 - 1994.04	82° Variante	<b>3136.82D50</b>
2.0		2.0	1989.05 - 1994.04	88° Variante	<b>3136.88D50</b>
2.0 i	RFZ (XU10J2)	2.0	1989.05 - 1994.06	82° Variante	<b>3136.82D50</b>
2.0 i	RFZ (XU10J2)	2.0	1989.05 - 1994.06	88° Variante	<b>3136.88D50</b>
2.0 i	RDZ (XU10MZ), XU102C, RFZ (XU10J2)	2.0	1991.11 - 1994.04	82° Variante	<b>3136.82D50</b>
2.0 i	RDZ (XU10MZ), XU102C, RFZ (XU10J2)	2.0	1991.11 - 1994.04	88° Variante	<b>3136.88D50</b>
2.0 i Turbo	RGY (XU10J2TE, Z)	2.0	1992.09 - 1994.06	82° Variante	<b>3136.82D50</b>
2.0 i Turbo	RGY (XU10J2TE, Z)	2.0	1992.09 - 1994.06	88° Variante	<b>3136.88D50</b>
2.0 Turbo	RGY (XU10J2TE, Z)	2.0	1992.09 - 1994.04	82° Variante	<b>3136.82D50</b>
2.0 Turbo	RGY (XU10J2TE, Z)	2.0	1992.09 - 1994.04	88° Variante	<b>3136.88D50</b>
2.1 D 12V	P9A (XUD11A)	2.1	1989.05 - 1994.06	Organisations no. O 5167→	<b>4447.85D</b>
2.1 TD 12V	PJZ (XUD11ATE), P8A (XUD11ATE), P8C (XUD11BTE), PHZ (XUD11ATE)	2.1	1989.05 - 1994.04	Automatikgetriebe	<b>4447.80D</b>
2.1 TD 12V	PJZ (XUD11ATE), P8A (XUD11ATE), P8C (XUD11BTE), PHZ (XUD11ATE)	2.1	1989.05 - 1994.04	Schaltgetriebe	<b>4447.85D</b>
<b>XM (Y4)</b>					
2.0 i 16V	RFV (XU10J4R)	2.0	1994.05 - 2000.10		<b>4450.83D</b>
2.0 Turbo	RGX (XU10J2TE)	2.0	1994.05 - 2000.10		<b>3136.82D50</b>
2.1 TD 12V	PJZ (XUD11ATE), P8A (XUD11ATE), P8C (XUD11BTE), PHZ (XUD11ATE)	2.1	1994.05 - 2000.10	Automatikgetriebe	<b>4447.80D</b>
2.1 TD 12V	PJZ (XUD11ATE), P8A (XUD11ATE), P8C (XUD11BTE), PHZ (XUD11ATE)	2.1	1994.05 - 2000.10	Schaltgetriebe	<b>4447.85D</b>
2.0 i 16V	RFV (XU10J4R)	2.0	1994.05 - 2000.10		<b>4450.83D</b>
2.0 Turbo	RGX (XU10J2TE), RGY (XU10J2TE, Z)	2.0	1994.05 - 2000.10		<b>3136.82D50</b>
2.1 D12	P9A (XUD11A)	2.1	1994.07 - 1996.06		<b>4447.85D</b>
2.1 TD 12V	PJZ (XUD11ATE), P8C (XUD11BTE), PHZ (XUD11ATE)	2.1	1994.05 - 2000.10	80° Variante	<b>4447.80D</b>
2.1 TD 12V	PJZ (XUD11ATE), P8C (XUD11BTE), PHZ (XUD11ATE)	2.1	1994.05 - 2000.10	85° Variante	<b>4447.85D</b>
<b>XSARA</b>					
1.4 i	KFX (TU3JP), KFW (TU3JP)	1.4	1997.04 - 2005.08	Organisations no. →O 08210	<b>3136.88D50</b>

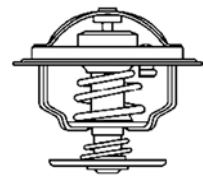

# CITROËN

	Engine	Ltr.	Year	Restriction*	Thermostat
1.4 i	KFX (TU3JP), KFW (TU3JP)	1.4	1997.05 - 2005.08	Organisations no. O 08211→	<b>410184.89D</b>
1.5 D	VJZ (TUD5)	1.5	1997.04 - 2000.09		<b>4821.89D</b>
1.6 16V	NFU (TU5JP4)	1.6	2000.09 - 2005.08		<b>3463.89D</b>
1.6 i	NFZ (TU5JP)	1.6	1997.04 - 2000.09	Organisations no. →O 08210	<b>3136.88D50</b>
1.6 i	NFZ (TU5JP)	1.6 i	1997.05 - 2000.09	Organisations no. O 08211→	<b>410184.89D</b>
1.8 D	A9A (XUD7), 161A (XUD7)	1.8	1997.04 - 2000.09		<b>4446.83D</b>
1.8 i	LFX (XU7JB), LFZ (XU7JP)	1.8	1997.04 - 2000.09		<b>3136.82D50</b>
1.8 i 16V	LFY (XU7JP4)	1.8	1997.04 - 2000.09		<b>4450.83D</b>
1.8 TD		1.8	1997.10 - 2000.09		<b>4446.83D</b>
1.9 D	WJY (DW8B), WJZ (DW8), DHV (XUD9BSD), DJY (XUD9A)	1.9	1997.04 - 2005.08		<b>4446.83D</b>
1.9 SD	DHV (XUD9BSD)	1.9	1998.01 - 2000.09		<b>4446.83D</b>
1.9 TD	DHY (XUD9TE, Y)	1.9	1997.04 - 2000.09		<b>4450.83D</b>
2.0 16V	RFV (XU10J4R) RFS (XU10J4RS)	2.0	1997.04 - 2000.09		<b>4450.83D</b>
2.0 16V	RFN (EW10J4)	2.0	2000.09 - 2005.08		<b>3483.89D</b>
2.0 HDi 109	RHZ (DW10ATED)	2.0	2001.05 - 2005.08		<b>4446.83D</b>
2.0 HDi 90	RHY (DW10TD)	2.0	1999.02 - 2005.08		<b>4446.83D</b>
2.0 i 16V	RFS (XU10J4RS)	2.0	1998.02 - 2005.03		<b>4450.83D</b>
<b>XSARA PICASSO (N68)</b>					
1.6	NFV (TU5JP), NFZ (TU5JP)	1.6	1999.12 -		<b>3463.89D</b>
1.6 16V	NFU (TU5JP4)	1.6	2005.09 -	Organisations no. →1088678	<b>3463.89D</b>
1.6 16V	NFU (TU5JP4)	1.6	2005.10 -	Organisations no. 1088778→	<b>410705.89D</b>
1.8 16V	6FZ (EW7J4)	1.8	2000.02 -		<b>3483.89D</b>
1.8 SX		1.8	2000.06 - 2005.08		<b>3483.89D</b>
2.0 16V	RFN (EW10J4)	2.0	2003.01 -		<b>3483.89D</b>
2.0 HDi	RHY (DW10TD)	2.0	1999.12 -		<b>4446.83D</b>
<b>ZX (N2)</b>					
1.1	H1A, H1B, HDZ (TU1M)	1.1	1991.03 - 1997.06		<b>3136.88D50</b>
1.4	KDZ (TU3M, Z)	1.4	1991.03 - 1997.06		<b>3136.88D50</b>
1.4 i	KDZ (TU3M, Z), KFX (TU3JP), KDX (TU3M, Z), KDY (TU3M)	1.4	1991.03 - 1997.06		<b>3136.88D50</b>
1.6 i	BFZ (XU5JP), BDY (XU5M)	1.6 i	1991.03 - 1997.10	82° Variante	<b>3136.82D50</b>
1.6 i	BFZ (XU5JP), BDY (XU5M)	1.6 i	1991.03 - 1997.10	88° Variante	<b>3136.88D50</b>
1.8 D	161A (XUD7)	1.8	1993.06 - 1997.10		<b>4446.83D</b>
1.8 i	LFZ (XU7JP)	1.8	1992.07 - 1997.10	82° Variante	<b>3136.82D50</b>
1.8 i	LFZ (XU7JP)	1.8	1992.07 - 1997.10	88° Variante	<b>3136.88D50</b>
1.8 i 16V	LFY (XU7JP4)	1.8	1996.01 - 1998.02		<b>4450.83D</b>
1.9 D	D9B (XUD9A, U), DJY (XUD9A), DJZ (XUD9Y)	1.9	1991.03 - 1997.10		<b>4446.83D</b>
1.9 DT		1.9	1992.06 - 1997.10		<b>4446.83D</b>
1.9 i	DKZ (XU9JA)	1.9	1991.03 - 1997.06	Automatikgetriebe	<b>3136.82D50</b>
1.9 i	DKZ (XU9JA)	1.9	1991.03 - 1997.06	Schaltgetriebe	<b>3136.88D50</b>
1.9 TD	DHY (XUD9TE, Y)	1.9	1992.07 - 1997.10		<b>4446.83D</b>
2.0	RFX (XU10J2C)	2.0	1994.07 - 1997.10	Automatikgetriebe	<b>3136.82D50</b>
2.0	RFX (XU10J2C)	2.0	1994.07 - 1997.10	Schaltgetriebe	<b>3136.88D50</b>
2.0 i	RFX (XU10J2C)	2.0	1992.07 - 1997.06	82° Variante	<b>3136.82D50</b>
2.0 i	RFX (XU10J2C)	2.0	1992.07 - 1997.06	88° Variante	<b>3136.88D50</b>
2.0 i 16V	RFT (XU10J4, Z), RFY (XU10J4, Z)	2.0	1992.07 - 1997.06		<b>4450.89D</b>
2.0 i 16V	RFS (XU10J4RS)	2.0	1996.05 - 1997.06		<b>4450.83D</b>

# Thermostats

## DACIA

	Engine	Ltr.	Year	Restriction*	Thermostat
<b>1300</b>					
1.3	810-02, -99	1.3	1972.12 - 1983.05		3029.89
<b>1310</b>					
1.3	810-02, -99	1.3	1983.05 - 2004.07		3029.89
<b>DOKKER</b>					
1.5 dCi	K9K 612	1.5	2012.11 -		411442.83D ▲
<b>DUSTER</b>					
1.5 dCi	K9K 796, 892, 894, 896, 898	1.5	2010.04 -		411039.83D
1.6 16V	K4M 606, 696	1.6	2010.04 -	Deckel Thermostatgehäuse	126104 ▲
1.6 16V	K4M 606, 696	1.6	2010.04 -		3466.89D
1.6 16V LPG	K4M 696	1.6	2011.04 -	Deckel Thermostatgehäuse	126104 ▲
1.6 16V LPG	K4M 696	1.6	2011.04 -		3466.89D
<b>LODGY</b>					
1.5 dCi		1.5	2010.06 -		411442.83D ▲
<b>LOGAN (LS_)</b>					
1.2 16V	D4F 732	1.2	2006.02 -		3166.89D
1.4	K7J 710	1.4	2004.09 -	Deckel Thermostatgehäuse	126104 ▲
1.4	K7J 710	1.4	2004.09 -		3466.89D
1.4 MPI LPG	K7J 714, K7J 710	1.4	2006.06 -	Deckel Thermostatgehäuse	126104 ▲
1.4 MPI LPG	K7J 714, K7J 710	1.4	2006.06 -		3466.89D
1.5 dCi	K9K 790	1.5	2005.09 -		411043.89D
1.5 dCi	K9K 792, K9K 796, K9K 892	1.5	2007.09 -		411039.83D
1.6	K7M 710	1.6	2004.09 -	Deckel Thermostatgehäuse	126104 ▲
1.6	K7M 710	1.6	2004.09 -		3466.89D
1.6 16V	K4M 696, K4M 690	1.6	2006.02 -	Deckel Thermostatgehäuse	126104 ▲
1.6 16V	K4M 696, K4M 690	1.6	2006.02 -		3466.89D
1.6 16V Flexifuel	K4M 696	1.6	2010.07 -	Deckel Thermostatgehäuse	126104 ▲
1.6 16V Flexifuel	K4M 696	1.6	2010.07 -		3466.89D
1.6 Bifuel	K7M 718	1.6	2010.05 -	Deckel Thermostatgehäuse	126104 ▲
1.6 Bifuel	K7M 718	1.6	2010.05 -		3466.89D
1.6 MPI 85	K7M 800	1.6	2010.05 -	Deckel Thermostatgehäuse	126104 ▲
1.6 MPI 85	K7M 800	1.6	2010.05 -		3466.89D
<b>LOGAN EXPRESS (FS_)</b>					
1.4	K7J 710	1.4	2009.03 -	Deckel Thermostatgehäuse	126104 ▲
1.4	K7J 710	1.4	2009.03 -		3466.89D
1.5 dCi	K9K 792, 796, 892	1.5	2009.03 -		411039.83D
1.6	K7M 710	1.6	2009.03 -	Deckel Thermostatgehäuse	126104 ▲
1.6	K7M 710	1.6	2009.03 -		3466.89D

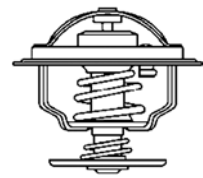

# DACIA

	Engine	Ltr.	Year	Restriction*	Thermostat
1.6 MPI 85	K7M 800	1.6	2010.05 -	Deckel Thermostatgehäuse	<b>126104 ▲</b>
1.6 MPI 85	K7M 800	1.6	2010.05 -		<b>3466.89D</b>
<b>LOGAN MCV (KS_)</b>					
1.4	K7J 710	1.4	2007.02 -	Deckel Thermostatgehäuse	<b>126104 ▲</b>
1.4	K7J 710	1.4	2007.02 -		<b>3466.89D</b>
1.5 dCi	K9K 792, 796, 892	1.5	2007.02 -		<b>411039.83D</b>
1.6	K7M 710	1.6	2007.02 -	Deckel Thermostatgehäuse	<b>126104 ▲</b>
1.6	K7M 710	1.6	2007.02 -		<b>3466.89D</b>
1.6 16V	K4M 694, K4M 690, 694, 696	1.6	2007.02 -	Deckel Thermostatgehäuse	<b>126104 ▲</b>
1.6 16V	K4M 694, K4M 690, 694, 696	1.6	2007.02 -		<b>3466.89D</b>
1.6 Bifuel	K7M 710	1.6	2008.11 -	Deckel Thermostatgehäuse	<b>126104 ▲</b>
1.6 Bifuel	K7M 710	1.6	2008.11 -		<b>3466.89D</b>
1.6 MPI 85	K7M 800	1.6	2010.05 -	Deckel Thermostatgehäuse	<b>126104 ▲</b>
1.6 MPI 85	K7M 800	1.6	2010.05 -		<b>3466.89D</b>
<b>LOGAN MCV II</b>					
1.5 dCi	K9K 612	1.5	2013.02 -		<b>411442.83D ▲</b>
	K9K 612	1.5	2012.10 -		<b>411442.83D ▲</b>
<b>LOGAN II</b>					
1.5 dCi					
<b>LOGAN Pick-up (US_)</b>					
1.4	K7J 710	1.4	2009.01 -	Deckel Thermostatgehäuse	<b>126104 ▲</b>
1.4	K7J 710	1.4	2009.01 -		<b>3466.89D</b>
1.5 dCi	K9K 792, 796, 892	1.5	2008.03 -		<b>411039.83D</b>
1.6	K7M 710	1.6	2008.03 -	Deckel Thermostatgehäuse	<b>126104 ▲</b>
1.6	K7M 710	1.6	2008.03 -		<b>3466.89D</b>
1.6 Bifuel	K7M 800	1.6	2010.05 -	Deckel Thermostatgehäuse	<b>126104 ▲</b>
1.6 Bifuel	K7M 800	1.6	2010.05 -		<b>3466.89D</b>
1.6 MPI 85	K7M 800	1.6	2010.05 -	Deckel Thermostatgehäuse	<b>126104 ▲</b>
1.6 MPI 85	K7M 800	1.6	2010.05 -		<b>3466.89D</b>
<b>PICK UP</b>					
1.4		1.4	1989.09 - 2000.09	Deckel Thermostatgehäuse	<b>126104 ▲</b>
1.4		1.4	1989.09 - 2000.09		<b>3466.89D</b>
<b>SANDERO</b>					
1.2 16V	D4F 732	1.2	2008.11 -		<b>3166.89D</b>
1.2 16V LPG	D4F 732	1.2	2008.11 -		<b>3166.89D</b>
1.4	K7J 710	1.4	2008.06 -	Deckel Thermostatgehäuse	<b>126104 ▲</b>
1.4	K7J 710	1.4	2008.06 -		<b>3466.89D</b>
1.4 MPI LPG	K7J 714	1.4	2009.01 -	Deckel Thermostatgehäuse	<b>126104 ▲</b>

# Thermostats

## DACIA

	Engine	Ltr.	Year	Restriction*	Thermostat
1.4 MPI LPG	K7J 714	1.4	2009.01 -		<b>3466.89D</b>
1.5 dCi	K9K 792, 796, 892	1.5	2008.11 -		<b>411039.83D</b>
1.6	K7M 710	1.6	2008.06 -	Deckel Thermostatgehäuse	<b>126104 ▲</b>
1.6	K7M 710	1.6	2008.06 -		<b>3466.89D</b>
1.6 16V	K4M 690	1.6	2011.07 -	Deckel Thermostatgehäuse	<b>126104 ▲</b>
1.6 16V	K4M 690	1.6	2011.07 -		<b>3466.89D</b>
1.6 16V Bifuel	K4M 696, K4M 694, K4M 690	1.6	2011.01 -	Deckel Thermostatgehäuse	<b>126104 ▲</b>
1.6 16V Bifuel	K4M 696, K4M 694, K4M 690	1.6	2011.01 -		<b>3466.89D</b>
1.6 MPI 85	K7M 800	1.6	2010.05 -	Deckel Thermostatgehäuse	<b>126104 ▲</b>
1.6 MPI 85	K7M 800	1.6	2010.05 -		<b>3466.89D</b>

## SANDERO II

1.2	D4F 732	1.2	2013.01 -		<b>3166.89D</b>
1.2 LPG	0	1.2	2013.01 -		<b>3166.89D</b>
1.5 dCi	K9K 612	1.5	2013.01 -		<b>411442.83D ▲</b>
					<b>1</b>

## SOLENZA

1.4	K7J 710	1.4	2003.02 -	Deckel Thermostatgehäuse	<b>26104 ▲</b>
1.4	K7J 710	1.4	2003.02 -		<b>3466.89D</b>

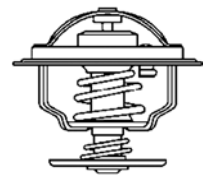

# DAEWOO

	Engine	Ltr.	Year	Restriction*	Thermostat
<b>ESPERO (KLEJ)</b>					
1.5 16V	A15MF	1.5	1993.10 - 1999.06		3017.92D2
1.8	C18LE	1.8	1995.02 - 1999.09		4180.82D
2.0	C20LE, C20LZ	2.0	1991.10 - 1999.06		4180.82D
<b>EVANDA (KLAL)</b>					
2.0	L88, X 20 SED	2.0	2002.08 -		4177.92D
<b>KALOS (KLAS)</b>					
1.2	F12S3, B12S1	1.2	2003.04 -		410183.88D
1.4	F14D3, F14S3	1.4	2003.05 - 2004.12		3017.87D2
1.4 16V	F14D3	1.4	2003.04 -		3017.87D2
<b>KORANDO (KJ)</b>					
2.9 D	MB-OM 662	2.9	1999.01 -		4176.85D
2.9 TD	MB-OM 601 29TD	2.9	1999.01 -		4176.85D
3.2	M 104.995	3.2	1999.01 -		4078.87D
<b>LACETTI (KLAN)</b>					
1.4	F14D3	1.4	2004.02 -		3017.87D2
1.6	F16D3	1.6	2004.02 -		3017.87D2
1.8	T18SED	1.8	2004.02 -		4189.87D
<b>LANOS (KLAT)</b>					
1.4	A14SMS	1.4	1997.05 -		3017.87D2
1.5	A15SMS	1.5	1997.10 - 1999.06	2-teiliges Aluminiumgehäuse	3017.87D2
1.5	A15SMS	1.5	1997.10 - 1999.06	2-teiliges Aluminiumgehäuse	3017.87D2
1.6 16V	A16DMS	1.6	1997.05 -		3017.87D2
<b>LEGANZA (KLAV)</b>					
1.8 CD	C18LE	1.8	1997.06 - 2003.07		4189.87D
2.0		2.0	2001.01 - 2002.12		4189.87D
2.0 16V	T20SED, X 20 SED	2.0	2000.07 - 2004.04		4189.87D
2.2 16V	T22SED	2.2	1999.04 - 2002.12		4189.87D
<b>MATIZ (KLYA)</b>					
0.8	F8CV	0.8	1998.09 -		410183.82D
1.0	B10S	1.0	2003.01 -		410183.82D
<b>MUSSO (FJ)</b>					
2.2 TD	MB OM 601	2.2	1999.09 -		4176.85D
2.3	M 111.970	2.3	1999.01 -		4276.87D
2.9 D	MB-OM 662	2.9	1999.01 - 1999.09		4176.85D
2.9 TD	MB-OM 601 29TD	2.9	1999.01 -		4176.85D
3.2	M 104.992	3.2	1999.01 -		4078.87D
<b>NEXIA (KLETN)</b>					
1.5	G15MF	1.5	1995.02 - 1997.08		3017.87D2
1.5 16V	A15MF	1.5	1995.02 - 1997.08		3017.92D2



# Thermostats

## DAEWOO

Engine

Ltr.

Year

Restriction\*

Thermostat

### NUBIRA (KLAJ)

1.6 16V	A16DMS	1.6	1997.05 -		<b>3017.87D2</b>
1.8	C18LE	1.8	1997.07 - 1999.05		<b>4180.82D</b>
2.0 16V	T20SED, X 20 SED, Z20L	2.0	1997.05 -		<b>4189.87D</b>

### NUBIRA (KLAN)

1.4	F14D3	1.4	2003.10 - 2004.12		<b>3017.87D2</b>
1.6	F16D3	1.6	2003.07 -		<b>3017.87D2</b>
1.8	C18LE, T18SED	1.8	2007.03 -		<b>4189.87D</b>

### REXTON

2.9 TD	OM 662.983	2.9	2002.04 -		<b>4176.85D</b>
--------	------------	-----	-----------	--	-----------------

### REZZO (KLAU)

1.6	A16DMS	1.6	2000.09 -		<b>3017.87D2</b>
1.8	A18DMS, F18D2, F18S2	1.8	2000.09 -		<b>3017.87D2</b>
2.0	T20SED, X 20 SED	2.0	2000.09 -		<b>4189.87D</b>

### TICO (KLY3)

0.8	F8C, F8CV	0.8	1996.01 - 2000.12		<b>410183.88D</b>
-----	-----------	-----	-------------------	--	-------------------

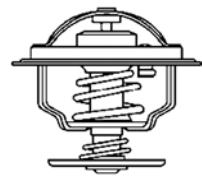

# DAF

	Engine	Ltr.	Year	Restriction*	Thermostat
<b>55</b>					
1.1	DBB 110E	1.1	1967.10 - 1972.09		<b>3029.83</b>
1.1 MARATHON	110F	1.1	1971.12 - 1972.09		<b>3029.83</b>
<b>66</b>					
1.1	110E	1.1	1972.10 - 1975.08		<b>3029.83</b>
1.1 MARATHON	110G	1.1	1972.10 - 1975.08		<b>3029.83</b>
1.1 SL	110G	1.1	1972.10 - 1975.08		<b>3029.83</b>
1300 MARATHON	B13,0S	1.3	1973.09 - 1975.08		<b>3029.83</b>

## DAIHATSU

	Engine	Ltr.	Year	Restriction*	Thermostat
<b>APPLAUSE I (A101, A111)</b>					
1.6 16V	HD, HD-E	1.6	1989.06 - 1997.07		410182.84D
<b>APPLAUSE II</b>					
1.6 16V	HD-E	1.6	1997.07 - 2000.05		410182.84D
<b>BEGO</b>					
1.3 DVVT	K3-VE	1.3	2005.11 -		410201.80D
1.5 DVVT	3SZ-VE	1.5	2005.11 -		410201.80D
<b>CHARADE I (G10)</b>					
1.0	CB 20, CB 22	1.0	1977.10 - 1983.02		410183.82D
<b>CHARADE II (G11, G30)</b>					
1.0	CB 22, CB 20	1.0	1983.10 - 1987.03		410183.82D
1.0 D	CL 10	1.0	1983.10 - 1987.03		4126.88
1.0 TD	CL 60	1.0	1985.02 - 1987.03		4126.88
1.0 Turbo	CB 60	1.0	1983.10 - 1987.03		410183.82D
<b>CHARADE III (G100, G101, G102)</b>					
1.0	CB 23	1.0	1987.03 - 1992.12		410183.82D
1.0	CB 90	1.0	1989.04 - 1992.12		410183.82D
1.0 TD	CL, CL 61	1.0	1987.03 - 1992.12		4126.88
1.0 Turbo	CB 61	1.0	1987.03 - 1990.10		410183.82D
1.3	HC-C, HCE	1.3	1988.09 - 1993.02		410182.84D
1.3 i	HCE	1.3	1988.06 - 1993.01		410182.84D
<b>CHARADE IV (G200, G202, G203)</b>					
1.0	CB 22	1.0	1994.09 - 1996.03		410183.82D
1.3	HC	1.3	1996.09 - 1999.11		410182.84D
1.3 16V	HCE	1.3	1996.05 - 1999.11		410182.84D
1.3 i 16V	HC	1.3	1993.01 - 1999.11		410182.84D
1.5 16V	HEE	1.5	1994.10 - 1999.11		410182.84D
1.5 i 16V	HEE, HEEG	1.5	1994.07 - 1999.11		410182.84D
1.6 GTi	HD-E	1.6	1993.03 - 1999.11		410182.84D
<b>CHARADE (L2_)</b>					
1.0	EJ-VE	1.0	2003.03 -		410179.84D
<b>CHARMANT (A)</b>					
1.3	4K	1.3	1981.11 - 1987.07		4103.82D
1.6	2T, 4A	1.6	1981.11 - 1987.07		3119.82
<b>COPEN</b>					
0.7	JB, JB-DET	0.7	2003.09 -		3478.82D
1.3	K3-VE	1.3	2006.03 -		410201.80D
<b>CUORE I (L55, L60)</b>					
0.5	AB 30	0.5	1980.10 - 1985.09		3119.88
0.6	AD 10	0.6	1982.08 - 1985.09		3119.88

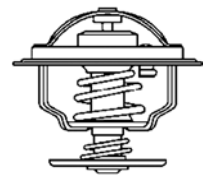

# DAIHATSU

	Engine	Ltr.	Year	Restriction*	Thermostat
<b>CUORE II (L80, L81)</b>					
0.8	ED 10	0.8	1985.09 - 1990.12		3119.88
<b>CUORE IV (L501)</b>					
0.8	ED 20	0.8	1995.01 - 1996.11		3119.82D5
<b>CUORE V (L5)</b>					
0.8	ED 20	0.8	1996.11 - 1998.10		3119.82D5
<b>CUORE VI (L7_)</b>					
1.0 DVVT	EJ-VE	1.0	2000.10 - 2003.02		410179.84D
1.0 i	EJ-DE	1.0	1998.10 - 2003.05		410179.84D
<b>CUORE VII (L251)</b>					
1.0	EJ-VE	1.0	2003.05 -		410179.84D
<b>CUORE VIII</b>					
1.0	1KR-FE	1.0	2007.04 -		410201.80D
<b>EXTOL (S22_, S23_)</b>					
1.3	K3-VE	1.3	2000.07 - 2003.09		410201.80D
<b>FEROZA (F300)</b>					
1.6 16V	HDC	1.6	1988.10 -		4103.82D
1.6 i 16V	HD-E	1.6	1988.10 -		4103.82D
<b>GRAN MOVE (G3)</b>					
1.5 16V	HEEG	1.5	1996.10 - 1998.07		410182.84D
1.5 GX, GLX	HEEG	1.5	1996.10 - 1998.08		410182.84D
1.6	HDEP	1.6	1998.07 - 2002.07		410182.84D
1.6 16V	HDEP	1.6	1998.05 -		410182.84D
1.6 GX, GLX	HDEP	1.6	1998.06 - 2002.07		410182.84D
<b>HIJET</b>					
0.8	CD	0.8	1986.06 - 1989.12		410183.82D
1.0	CB, CB41	1.0	1986.06 - 1989.12		410183.82D
1.0 i	CB42	1.0	1994.07 - 1998.05		410183.82D
1.2 D	LDW12	1.2	1995.05 - 1998.03		4007.80D
1.4 D	LDW14	1.4	1998.03 - 1999.12		4007.80D
<b>MATERIA (M4_)</b>					
1.3	K3-VE	1.3	2006.10 -		410201.80D
1.5	3SZ-VE	1.5	2006.10 -		410201.80D
<b>MOVE (L6, L9)</b>					
0.8	ED 20	0.8	1996.10 -		3119.82D5
1.0 i	EJ-DE	1.0	1998.10 -		410179.84D
<b>ROCKY (F7, F8)</b>					
2.0	3Y	2.0	1985.02 - 1993.04		4103.82D

# Thermostats

## DAIHATSU

Engine

Ltr.

Year

Restriction\*

Thermostat

### SIRION

1.0	EJ-DE	1.0	1998.04 - 2000.10		410179.84D
1.0	1KR-FE	1.0	2005.05 -		410179.84D
1.0 DVVT	1KR-FE	1.0	2005.04 -		410179.84D
1.0 i	EJ-DE, EJ-VE	1.0	1998.04 - 2005.01		410179.84D
1.3	K3-VE	1.3	2005.01 -		410201.80D
1.3 Sport	K3-VE2	1.3	2000.08 - 2005.03		410201.80D
1.5	3SZ-VE	1.5	2008.03 -		410201.80D

### SPARCAR (S7\_)

0.8	CD	0.8	1983.09 - 1986.05		410183.82D
1.0	CB	1.0	1983.09 - 1986.05		410183.82D

### TERIOS (J1)

1.3	HE-EJ	1.3	1997.10 - 2000.10		410182.84D
1.3	K3-VE	1.3	2000.10 - 2005.10		410201.80D
1.3 DVVT	K3-VE	1.3	2005.11 -		410201.80D
1.5	3SZ-VE	1.5	2005.11 -		410201.80D
1.5 DVVT	3SZ-VE	1.5	2010.09 -		410201.80D

### TREVIS

1.0	EJ-VE	1.0	2006.06 -		410179.84D
-----	-------	-----	-----------	--	------------

### XENIA

1.5	3SZ-VE	1.5	2007.06 -		410201.80D
-----	--------	-----	-----------	--	------------

### YRV (M2)

1.0	EJ-VE	1.0	2001.02 -		410179.84D
1.3	K3-VE	1.3	2001.02 -		410201.80D
1.3 GTi	K3-VET	1.3	2002.02 -		410201.80D

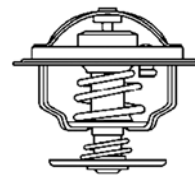

# DODGE

	Engine	Ltr.	Year	Restriction*	Thermostat
<b>CARAVAN</b>					
2.5 TD	ENC	2.5	1995.01 - 2001.03		4158.80D
<b>NEON</b>					
2.0 16V	ECB	2.0	1994.05 - 1999.08		410262.91D
2.0 16V	ECC	2.0	1994.06 - 1999.08		410262.91D
2.0 16V	ECH	2.0	1999.08 -		410262.91D
<b>STRATUS</b>					
2.0 16V	ECB	2.0	1995.12 - 2001.04		410262.91D
2.4 16 V	EDZ	2.4	1995.12 - 2001.04		410262.91D
2.5 V6	EEB	2.5	1995.12 - 2001.04		410180.82D

# Thermostats

## FIAT

	Engine	Ltr.	Year	Restriction*	Thermostat
<b>124 Spider</b>					
1500 Sport (BS)	124 AC.000	1.5	1966.01 - 1972.12		3023.87D
<b>126</b>					
700	126 A2.000, 126 A2.048	0.7	1987.09 - 1996.06		3383.87
<b>127</b>					
1.0	127 A.000, 127 A1.000	1.0	1977.01 - 1986.12		4091.82D
<b>130</b>					
3.2	130 B.000	3.2	1971.10 - 1978.03		4033.82D
<b>131</b>					
2.0 D	8144.65	2.0	1978.07 - 1984.08		4008.79D
2.5 D, Super Diesel (AF)	8144.61	2.5	1978.06 - 1984.12		4008.79D
<b>132</b>					
2.0 D	8144.65	2.0	1978.07 - 1982.07		4008.79D
2.5 D	8144.61	2.5	1978.07 - 1982.07		4008.79D
<b>500</b>					
0.9	199 B6.000, 312 A2.000, 312 A4.000	0.9	2009.09 -		410090.88D
1.3 D Multijet	199 B1.000	1.3	2009.09 -		411774.88D ▲
1.4	169 A3.000, 312 A1.000, 843 A1.000	1.4	2007.10 -		410090.88D
1.4 Abarth	312 A3.000	1.4	2008.08 -		410871.80D ▲
<b>ARGENTA (132A)</b>					
2500 Diesel	8144.61	2.5	1981.06 - 1985.11		4008.79D
2500 Turbodiesel	8144.61.500.81	2.5	1983.07 - 1985.08		4008.79D
<b>BARCETTA (183)</b>					
1.8 16V	183 A1.000, 183 A6.000	1.8	1995.04 - 2005.05	Chassis No. 20000→	410514.88D
<b>BRAVA, BRAVO (182)</b>					
1.2 16V 80	182 B2.000, 188 A5.000	1.2	1998.12 - 2002.12		3151.87D
1.4	182 A3.000, 182 A5.000,	1.4	1995.10 - 2001.10	ohne Klimaanlage	410515.88D
1.4	182 A3.000, 182 A5.000,	1.4	1995.10 - 2001.10	mit Klimaanlage	410516.88D
1.4 12V	182 A3.000	1.4	1995.10 - 1998.08	ohne Klimaanlage	410515.88D
1.4 12V	182 A3.000	1.4	1995.10 - 1998.08	mit Klimaanlage	410516.88D
1.6	182 B6.000	1.6	2000.09 - 2002.02		3163.88D
1.6 16V	182 A4.000, 182 A6.000	1.6	1995.10 - 1998.04	Gewinde 2x, Motor no. 9762821→	3481.88D
1.6 16V	182 A4.000, 182 A6.000	1.6	1998.04 - 2001.10	Gewinde 1x,	3163.88D
1.6 16V	182 B6.000	1.6	1999.01 - 2002.12		3163.88D
1.9 D	160 A7.000	1.9	1995.10 - 2001.10	ohne Klimaanlage	3431.80D
1.9 JTD 105	182 B4.000	1.9	1998.12 - 2001.10		410512.88D
2.0 HGT 20V	182 A1.000, 182 B7.000	2.0	1995.10 - 1998.07		410513.88D
<b>BRAVO (198)</b>					
1.4	192 B2.000	1.4	2007.04 -		3151.87D
1.4 16V	198 A7.000	1.4	2008.03 -		410871.80D ▲

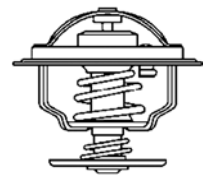

# FIAT

	Engine	Ltr.	Year	Restriction*	Thermostat
1.4 LPG	192 B2.000	1.4	2009.11 -		410090.88D
1.9 D Multijet	192 A1.000, 192 A8.000, 192 B4.000, 192 B5.000	1.9	2006.11 -		410511.88D
1.9 D Multijet	937 A5.000	1.9	2007.04 -		411773.88D ▲
<b>CINQUECENTO (170)</b>					
0.7	170 A.000	0.7	1991.12 - 1996.01		3485.87D
0.7 i	170 A.046	0.7	1994.07 - 1996.01		3484.87D
0.9 i.e. (170AC)	170 A1.046	0.9	1991.07 - 1993.12		410007.87D
0.9 i.e. S (170AF, 170CF)	1170 A1.000, 1170 A1.046	0.9	1991.07 - 1999.07		410007.87D
1.1 Sporting	176 B2.000	1.1	1994.10 - 1998.01		3105.87D
<b>COUPE</b>					
2.0 20V	182 A1.000, 182 B3.000	2.0	1996.08 - 1998.04		410513.88D
<b>CROMA (154)</b>					
2000 CHT	154 A1.000	2.0	1985.12 - 1992.09		4022.82D1
2000 i.e.	834 B.048	2.0	1986.03 - 1990.09		4022.82D1
2000 i.e.	834 B.000, 834 B.146	2.0	1987.03 - 1996.08		4022.82D1
2000 i.e.	154 C3.000, 154 C3.046	2.0	1987.03 - 1996.08		4022.82D1
2000 i.e. Turbo	154 A2.000, 154 C4.046, 834 C.146	2.0	1985.12 - 1996.08		4022.82D1
2500 D	8144.67	2.5	1985.12 - 1989.12		4151.79D
2500 TD	8144.91.2000	2.5	1985.12 - 1988.10		4008.79D
2500 TD	8144.91.2000	2.5	1988.11 - 1989.08		3103.79
2500 TD	8144.97, 8144.97 Y, 8144.97.2400	2.5	1989.05 - 1996.08		3116.82D
2500 TDE	8144.97 S	2.5	1991.12 - 1996.08		3116.82D
<b>CROMA (194)</b>					
1.8 16V	939 A4.000	1.8	2005.12 -		4431.105D
1.9 D Multijet	939 A1.000, 939 A2.000, 939 A7.000, 939 A8.000	1.9	2005.06 -		410049.88D
2.2 16V	194 A1.000	2.2	2005.06 -		411193.82D
<b>DOBLÒ (119)</b>					
1.2	223 A5.000	1.2	2001.03 -		3105.87D
1.3 D Multijet	223 A9.000	1.3	2005.10 -		410048.88D
1.3 JTD	199 A2.000	1.3	2005.05 -		410048.88D
1.4	350 A1.000	1.4	2005.05 -		410090.88D
1.6 16V	182 B6.000	1.6	2001.10 -		3163.88D
1.6 Natural Power	182 B6.000	1.6	2002.09 -		3163.88D
1.9 D Multijet	186 A9.000	1.9	2005.10 -		410589.88D
1.9 JTD	182 B9.000, 223 A7.000, 223 B1.000, 223 B2.000	1.9	2001.10 -		410589.88D
<b>DOBLÒ (223)</b>					
1.2 (223ZX1A)	223 A5.000	1.2	2001.03 -		3105.87D
1.3 D Multijet	199 A2.000	1.3	2005.05 - 2010.01		410048.88D
1.3 JTD 16V Multijet	223 A9.000	1.3	2006.08 -		410048.88D
1.4	350 A1.000	1.4	2005.10 -		410090.88D
1.6 16V	182 B6.000	1.6	2001.10 -		3163.88D
1.6 Natural Power	182 B6.000	1.6	2002.09 -		3163.88D
1.9 JTD	182 B9.000, 223 B1.000, 223 A7.000	1.9	2001.10 -		410589.88D



## FIAT

Engine

Ltr.

Year

Restriction\*

Thermostat

### DOBLO (263)

1.4	843 A1.000	1.4	2010.02 -		410090.88D
-----	------------	-----	-----------	--	------------

### DUCATO (230)

1.9 D	D9B, DJY, D9B (XUD9A)	1.9	1998.04 - 2002.04		4446.83D
1.9 D	DJY, DHX	1.9	1998.04 - 2002.04		4446.83D
1.9 TD	DHX (XUD9TF, L)	1.9	1998.04 - 2002.04		4450.83D
2.0	RFW	2.0	1994.03 - 2002.04		3136.82D50
2.0 JTD	RHV (DW10)	2.0	2001.10 - 2002.04		4446.83D
2.5 D	8140.67	2.5	1994.03 - 2002.04	82° Variante	4174.82D
2.5 D	8140.67	2.5	1994.03 - 2002.04	88° Variante	4174.88D ▲
2.5 TD	8140.47	2.5	1994.06 - 2001.09	82° Variante	4174.82D
2.5 TD	8140.47	2.5	1994.06 - 2001.09	88° Variante	4174.88D ▲
2.5 TDI	8140.473, 8140.47R	2.5	1994.03 - 2002.04	82° Variante	4174.82D
2.5 TDI	8140.473, 8140.47R	2.5	1994.03 - 2002.04	88° Variante	4174.88D ▲
2.8 D	8140.63	2.8	1998.02 - 2002.04	82° Variante	4174.82D
2.8 D	8140.63	2.8	1998.02 - 2002.04	88° Variante	4174.88D ▲
2.8 IDTD	8140.43	2.8	1998.05 - 2001.09	79° Variante	4174.79D
2.8 IDTD	8140.43	2.8	1998.05 - 2001.09	82° Variante	4174.82D
2.8 IDTD	8140.43	2.8	1998.05 - 2001.09	88° Variante	4174.88D ▲
2.8 JTD	8140.43S	2.8	2000.11 - 2002.04	82° Variante	4174.82D
2.8 JTD	8140.43S	2.8	2000.11 - 2002.04	88° Variante	4174.88D ▲
2.8 JTD	8140.43S	2.8	2001.03 - 2002.04	82° Variante	4174.82D
2.8 JTD	8140.43S	2.8	2001.03 - 2002.04	88° Variante	4174.88D ▲
2.8 TD, TDI	8140.43, 8140.63	2.8	1998.05 - 2001.09	79° Variante	4174.79D
2.8 TD, TDI	8140.43, 8140.63	2.8	1998.05 - 2001.09	82° Variante	4174.82D
2.8 TD, TDI	8140.43, 8140.63	2.8	1998.05 - 2001.09	88° Variante	4174.88D ▲

### DUCATO (244)

2.0	RFL	2.0	2002.04 -		3136.82D50
2.0 Bipower	RFL	2.0	2002.11 -		3136.82D50
2.0 JTD	RHV (DW10)	2.0	2002.04 - 2006.07		4446.83D
2.3 JTD	F1AE0481C	2.3	2002.04 - 2006.07		3171.82D
2.8 JTD, TD, TDS	8140.23, 8140.43	2.8	2002.04 - 2006.07	82° Variante	4174.82D
2.8 JTD, TD, TDS	8140.23, 8140.43	2.8	2002.04 - 2006.07	88° Variante	4174.88D ▲

### DUCATO (250)

100 Multijet 2.2 D	4HV	2.2	2006.07 -		3497.88D
120 Multijet 2.3 D	F1AE0481D, F1AE3481D	2.3	2006.07 -		410937.82D ▲
130 Multijet 2.3 D	F1AE0481N, F1AE3481D	2.3	2007.01 -		410937.82D ▲
150 Multijet 3.0 D	F1CE3481N	3.0	2010.04 -		410075.79D ▲
160 Multijet 3.0 D	F1CE0481D, F1CE3481M	3.0	2006.07 -		410075.79D ▲
3.0 D Multijet	F1CE3481E	3.0	2011.06 -		410075.79D ▲

### DUCATO (280)

1.8	169 B, XM7T	1.8	1982.01 - 1988.12		3061.82
1.9 D	149 B1.000	1.9	1987.02 - 1990.08		3431.80D
1.9 TD	280 A1.000	1.9	1989.03 - 1990.08		3431.80D
2.0	170 B, 170 D, XN 1T	2.0	1982.01 - 1990.08		3061.82
2.4 D	8144.61	2.4	1982.01 - 1990.08		4008.79D
2.5 D	CRD93L (U25-661), 8144.67	2.5	1982.01 - 1990.08	82° Variante	4174.82D
2.5 D	CRD93L (U25-661), 8144.67	2.5	1982.01 - 1990.08	88° Variante	4174.88D ▲
2.5 D	8140.61, 8144.61	2.5	1986.09 - 1990.05		4008.79D
2.5 TD	8144.21	2.5	1986.01 - 1990.08	82° Variante	4174.82D
2.5 TD	8144.21	2.5	1986.01 - 1990.08	88° Variante	4174.88D ▲

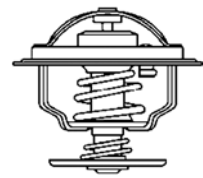

# FIAT

	Engine	Ltr.	Year	Restriction*	Thermostat
<b>DUCATO (290)</b>					
1.9 D	149 B1.000	1.9	1990.07 - 1994.03		3431.80D
1.9 TD	280 A1.000	1.9	1989.03 - 1994.03		3431.80D
2.0	170 D	2.0	1990.06 - 1994.05		3061.82
2.5 D, TD	8140.27, 8144.67	2.5	1990.06 - 1994.03	82° Variante	4174.82D
2.5 D, TD	8140.27, 8144.67	2.5	1990.06 - 1994.03	88° Variante	4174.88D ▲
<b>DUNA (146 B)</b>					
1.7 DS	149 B3.000	1.7	1987.01 - 1991.12		3431.80D
60 1.1	146 A6.000	1.1	1987.01 - 1991.12		4091.82D
70 1.3	146 A5.000	1.3	1987.01 - 1991.12		4091.82D
<b>ELBA</b>					
1.3		1.3	1986.04 - 1993.12		4091.82D
1.5	149 C1.000	1.5	1992.01 - 1996.12		4091.82D
1.7 D	146 B2.000	1.7	1989.04 - 1996.12		3431.80D
<b>FIORINO (127)</b>					
1050	127 A.000	1.05	1980.01 - 1987.12		4091.82D
<b>FIORINO (146 Uno)</b>					
60 1.1	146 A9.000	1.1	1988.05 - 1993.12		4091.82D
60 1.7 D	146 B2.000, 149 B3.000	1.7	1988.05 - 2000.05		3431.80D
65 1.7 TD	146 D7.000	1.7	1997.01 - 2001.05	mit Klimaanlage	4246.80D
65 1.7 TD	146 D7.000	1.7	1997.01 - 2001.05	ohne Klimaanlage	4247.80D
70 1.3	146 A5.000	1.3	1988.01 - 1994.12		4091.82D
1.7 D	146 B2.000, 149 B3.000	1.7	1993.10 - 1999.10		3431.80D
1.7 TD	146 D7.000	1.7	1997.01 - 2001.05	Ölkühlung	410692.71D
1.7 TD	146 D7.000	1.7	1997.01 - 2001.05	mit Klimaanlage	4246.80D
1.7 TD	146 D7.000	1.7	1997.01 - 2001.05	ohne Klimaanlage	4247.80D
<b>FIORINO (147)</b>					
1.0	127 A.000, 156 A.000	1.0	1980.01 - 1988.04		4091.82D
1.1	146 A9.000	1.1	1986.11 - 1988.12		4091.82D
1.3	146 A5.000	1.3	1987.12 - 1993.08		4091.82D
1.3 D	127 A5.000	1.3	1982.03 - 1988.12		3355.80D
1.7 D	149 B2.000, 149 B3.000	1.7	1988.01 - 1993.10		3431.80D
<b>FIORINO</b>					
1.3 D Multijet	199 A2.000, 199 A9.000	1.3	2007.11 -		410048.88D
1.4	KFT, KFV	1.4	2007.11 -		3463.89D
1.4 Natural Power	350 A1.000	1.4	2009.10 -		410090.88D
<b>IDEA</b>					
1.2 16V	188 A5.000	1.2	2004.01 -		3151.87D
1.3 D Multijet	199 A3.000, 199 B1.000	1.3	2005.10 -		410048.88D
1.4	192 B2.000	1.4	2003.12 -		3151.87D
1.4	350 A1.000	1.4	2005.10 -		410090.88D
1.4 16V	843 A1.000	1.4	2004.01 -		3151.87D
1.4 LPG	350 A1.000	1.4	2009.03 -		410090.88D

# FIAT

Engine

Ltr.

Year

Restriction\*

Thermostat

## LINEA

1.3 D Multijet	199 A3.000	1.3	2007.06 -		410048.88D
1.4	350 A1.000	1.4	2007.06 -		410090.88D

## MAREA (185)

1.2 16V	182 B2.000	1.2	1998.10 - 2002.05		3151.87D
1.4 80 12V	182 A3.000	1.4	1996.09 - 2002.05	ohne Klimaanlage	410515.88D
1.4 80 12V	182 A3.000	1.4	1996.09 - 2002.05	mit Klimaanlage	410516.88D
1.6	182 B6.000	1.6	2000.09 - 2002.08		3163.88D
1.6 100 16V	182 A4.000	1.6	1998.04 - 2002.05	Gewinde 1x	3163.88D
1.6 100 16V	182 A4.000	1.6	1996.09 - 1998.04	Gewinde 2x, Motor no. 9762821→	3481.88D
1.6 100 16V Bipower	186 A4.000, 185 A3.000	1.6	1999.04 - 2002.05	Gewinde 2x	3481.88D
1.9 JTD 105	182 B4.000	1.9	1999.04 - 2002.05		410512.88D
2.0 150 20V	182 A1.000, 185 A8.000	2.0	1996.09 - 2002.05		410513.88D
2.0 155 20V	182 B7.000	2.0	1999.04 - 2003.02		410513.88D

## MULTIPLA (186)

1.6	182 B6.000	1.6	2000.09 - 2010.06		3163.88D
1.6 100 16V	182 A4.000	1.6	1999.04 - 2010.06		3163.88D
1.6 16V	182 B6.000	1.6	2002.04 - 2010.06		3163.88D
1.6 16V Bipower	182 B6.000, 186 A4.000	1.6	1999.04 - 2010.06		3163.88D
1.6 16V Blupower	186 A3.000	1.6	1999.04 - 2010.06		3163.88D
1.9 JTD 105	182 B4.000	1.9	1999.04 - 2010.06		410512.88D

## PALIO

1.2	176 A8.000, 178 B5.000, 178 C4.066, 178 E2.000, 188 A4.000	1.2	1996.04 -		3105.87D
1.2	188 A5.000	1.2	2001.09 -		3151.87D
1.4	834 A1.000	1.4	2003.06 -		410090.88D
1.6 16V	178 B3.000	1.6	1996.04 - 2001.02	Gewinde 2x, Motor no. →60933	3481.88D
1.6 16V	178 B3.000	1.6	1996.05 - 2001.02	Gewinde 1x, Motor no. 60933→	3163.88D
1.6 16V	182 B6.000	1.6	2001.02 -	Motor no. 60933→	3163.88D
1.7 TD	176 A3.000, 176 A5.000	1.7	1996.04 - 2001.03	Ölkühlung	410692.71D
1.7 TD	176 A3.000, 176 A5.000	1.7	1996.04 - 2001.03	ohne Klimaanlage	4434.80D
1.7 TD	176 A3.000, 176 A5.000	1.7	1996.04 - 2001.03	mit Klimaanlage	4436.80D

## PANDA

750	156 A4.000	0.75	1986.01 - 1995.01		3105.87D
750	141 B.000	0.75	1986.01 - 1995.01		3361.87D
750	156 A4.048	0.75	1995.04 - 2003.10		3105.87D
900	146 A.000, 100 GL3.000	0.9	1980.10 - 1994.06		3361.87D
900	1170 A1.046	0.9	1992.04 - 1996.12		3361.87D
1000	141 C2.000, 156 A2.100, 156 A3.000, 156 A2.246	1.0	1985.01 - 1994.12		3105.87D
1000 i.e.	141 C2.000, 156 A2.246	1.0	1987.10 - 2004.02		3105.87D
1100	156 C.046, 187 A1.000, 176 B2.000	1.1	1991.05 - 2004.07		3105.87D
1300 D	156 A5.000	1.3	1986.04 - 1992.12		3373.80D

## PANDA (169)

1.1	187 A1.000	1.1	2003.09 -		3105.87D
1.2	188 A4.000	1.2	2003.09 -		3105.87D
1.2	169 A4.000	1.2	2010.09 -		410090.88D

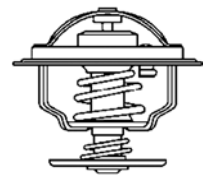

# FIAT

	Engine	Ltr.	Year	Restriction*	Thermostat
1.2 Bi-Power	188 A4.000	1.2	2007.01 -		3105.87D
1.2 LPG	188 A4.000	1.2	2009.04 -		3105.87D
1.2 LPG	169 A4.000	1.2	2010.11 -		3105.87D
1.4	169 A3.000	1.4	2006.10 -		410090.88D
1.4 Bi-Power	350 A1.000	1.4	2010.09 -		410090.88D
1.4 Natural Power	350 A1.000	1.4	2010.01 -		410090.88D
<b>PUNTO (176)</b>					
1.1	176 B2.000	1.1	1996.04 - 2000.02		3105.87D
1.2 16V	176 B9.000	1.2	1997.04 - 1999.09		3105.87D
1.4 GT Turbo	176 A4.000, 176 B6.000	1.4	1994.01 - 1996.09	Ölkühlung	410692.71D
1.7 D	176 B3.000	1.7	1994.04 - 2000.02		3300.80D
1.7 TD	176 A5.000	1.7	1994.01 - 2000.02	mit Klimaanlage	3301.80D
1.7 TD	176 A5.000	1.7	1994.01 - 2000.02	Motor no. →1897563, ohne Klimaanlage	3302.80D
1.7 TD	176 A3.000, 176 A5.000	1.7	1994.01 - 1999.09	Ölkühlung	410692.71D
1.7 TD	176 A3.000	1.7	1994.01 - 1999.09	Motor no. →1897563, ohne Klimaanlage	4434.80D
1.7 TD	176 A3.000	1.7	1994.01 - 1999.09	mit Klimaanlage	4436.80D
1.7 TD	176 B7.000	1.7	1996.09 - 1999.09	mit Klimaanlage	4436.80D
55 1.1	176 A6.000, 176 B2.000	1.1	1993.09 - 1999.09		3105.87D
60 1.2	176 A7.000, 176 B1.000, 176 B4.000	1.2	1994.01 - 2000.06		3105.87D
75 1.2	176 A8.000	1.2	1993.10 - 1999.09		3105.87D
85 16V 1.2	176 B9.000	1.2	1997.04 - 2000.06		3105.87D
<b>PUNTO (188)</b>					
1.2 16V 80	188 A5.000	1.2	1999.09 -		3151.87D
1.2 60	188 A4.000	1.2	1999.09 - 2009.10		3105.87D
1.2 Natural Power	188 A4.000	1.2	2003.09 -		3105.87D
1.4	843 A1.000	1.4	2003.09 -		3151.87D
1.8 130 HGT	183 A1.000, 188 A6.000	1.8	1999.09 -		410514.88D
1.9 JTD	188 A7.000	1.9	2000.02 - 2009.10		410591.88D
1.9 JTD 80	188 A2.000	1.9	1999.09 -		410591.88D
<b>PUNTO / GRANDE PUNTO (199)</b>					
0.9 Twinair Turbo	312 A2.000	0.9	2012.03 -		410090.88D
1.2	169 A4.000, 199 A4.000	1.2	2010.09 -		410090.88D
1.3 D Multijet	199 A2.000, 199 A3.000, 199 A9.000	1.3	2005.10 -		410048.88D
1.4	199 A7.000, 350 A1.000	1.4	2005.10 -		410090.88D
1.4 16V	199 A6.000	1.4	2005.10 -		410090.88D
1.4 16V	955 A6.000	1.4	2009.09 -		410871.80D ▲
1.4 LPG	350 A1.000	1.4	2008.08 -		410090.88D
1.4 Multi Air	955 A6.000	1.4	2012.03 -		410871.80D ▲
1.4 Natural Power	350 A1.000	1.4	2008.07 -		410090.88D
1.4 Turbo Multi Air	955 A2.000	1.4	2012.03 -		410871.80D ▲
1.9 D Multijet	199 A5.000, 939 A1.000, 939 A7.000	1.9	2005.10 -		410049.88D
<b>PUNTO EVO (199)</b>					
1.2	169 A4.000, 199 A4.000	1.2	2009.10 - 2012.02		410090.88D
1.3 D Multijet	199 A2.000, 199 A9.000, 199 B2.000, 199 B4.000, 223 A9.000	1.3	2008.07 - 2012.02		410048.88D
1.4	199 A7.000, 350 A1.000	1.4	2009.07 - 2012.02		410090.88D
1.4 16V	955 A2.000, 955 A6.000	1.4	2009.10 - 2012.02		410871.80D ▲
1.4 LPG	350 A1.000	1.4	2009.06 - 2012.02		410090.88D
1.4 Natural Power	350 A1.000	1.4	2009.06 - 2012.02		410090.88D

# Thermostats

## FIAT

Engine

Ltr.

Year

Restriction\*

Thermostat

### QUBO

1.3 D Multijet	199 A2.000	1.3	2008.02 -		410048.88D
1.4	KFT, KFV	1.4	2008.02 -		3463.89D
1.4 Natural Power	350 A1.000	1.4	2009.10 -		410090.88D

### REGATA

60 Diesel 1.7	149 B3.000	1.7	1984.01 - 1989.12		3431.80D
65 Diesel 1.9	149 A1.000	1.9	1984.04 - 1989.07		3431.80D
80 Turbo Diesel 1.9	831 D1.000	1.9	1986.05 - 1989.07		3431.80D

### RITMO I (138A)

60 1.0	127 A6.000	1.0	1978.09 - 1982.09		4091.82D
--------	------------	-----	-------------------	--	----------

### RITMO II (138A)

60 Diesel 1.7	149 B3.000, 138 C.000	1.7	1985.05 - 1987.12		3431.80D
80 Turbo Diesel 1.9	831 D1.000	1.9	1985.12 - 1987.12		3431.80D

### SCUDO (220)

1.9 D	D9B, WJZ (DW8)	1.9	1996.02 - 2006.12		4446.83D
1.9 TD	D8B, DHX (XUD9TF, L)	1.9	1996.02 - 2006.12		4446.83D
2.0	RFN (EW10J4)	2.0	2000.05 - 2006.12		3463.89D
2.0 16V	RFN (EW10J4)	2.0	2000.06 - 2006.12		3483.89D
2.0 JTD	RHX, RHZ	2.0	1999.12 - 2006.12		4446.83D
2.0 JTD 16V	RHW (DW10ATED4)	2.0	1999.05 - 2006.12		4446.83D

### SEDICI

1.6 16V	M16A	1.6	2006.06 -		410229.82D
1.9 D Multijet	D19AA	1.9	2006.06 -		410049.88D

### SEICENTO (187)

0.9	1170 A1.046	0.9	1998.01 - 2010.01		410007.87D
1.1	187 A1.000, 176 B2.000	1.1	1998.01 - 2010.01		3105.87D

### SIENA

1.2	178 B5.000	1.2	1998.09 -		3105.87D
1.6 16V	178 B3.000	1.6	1998.09 -	Motor no. 60933→	3163.88D
1.7 TD	176 A3.000	1.7	2006.02 -	Ölkühlung	410692.71D

### STILO

1.2 16V	188 A5.000	1.2	2002.02 - 2006.11		3151.87D
1.4 16V	192 B2.000, 843 A1.000	1.4	2004.01 - 2008.08		3151.87D
1.6 16V	182 B6.000	1.6	2001.10 - 2008.08		3163.88D
1.6 16V	192 B3.000	1.6	2005.05 - 2006.11		4357.92D
1.8 16V	192 A4.000	1.8	2001.10 - 2008.08		410514.88D
1.9 D	192 B5.000	1.9	2004.09 - 2008.08		410511.88D
1.9 D Multijet	192 A8.000, 192 A9.000	1.9	2005.09 - 2008.08		410511.88D
1.9 D Multijet	937 A5.000	1.9	2005.09 - 2008.08		411773.88D ▲
1.9 JTD	192 A1.000, 192 A3.000, 937 A7.000	1.9	2001.10 - 2008.08		410511.88D
1.9 JTD	192 A5.000, 192 B1.000, 937 A4.000	1.9	2003.09 - 2008.08		411773.88D ▲
1.9 JTD	192 B5.000	1.9	2004.09 - 2006.11		410511.88D
2.4 20V	192 A2.000	2.4	2001.10 - 2006.11		410994.88D

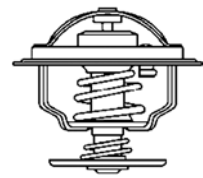

# FIAT

	Engine	Ltr.	Year	Einschränkung Restriction*	Thermostat
<b>STRADA (178E)</b>					
1.2	178 B5.000, 188 A4.000	1.2	1999.06 -		3151.87D
1.2		1.2	2005.11 -		3105.87D
1.3 D Multijet	223 A9.000	1.3	2006.05 -		410048.88D
1.7 TD	176 A3.000	1.7	1999.06 -	Ölkühlung	410692.71D
1.7 TD	176 A3.000	1.7	1999.06 -	ohne Klimaanlage	4434.80D
1.7 TD	176 A3.000	1.7	1999.06 -	mit Klimaanlage	4436.80D
<b>TALENTO (290)</b>					
1.9 D	149 B1.000	1.9	1989.03 - 1994.03		3431.80D
2.0	170 B	2.0	1989.03 - 1994.03		3061.82
<b>TEMPRA (159)</b>					
1.4 i.e.	159 A2.000, 160 A1.046, 836 A4.000	1.4	1991.03 - 1996.08		3109.87D
1.6	159 A3.000	1.6	1990.03 - 1993.04		3109.87D
1.6 i.e.	159 A3.046	1.6	1990.06 - 1992.07		3109.87D
1.8	159 A4.000	1.8	1992.07 - 1993.06		3159.82D
1.8 i.e.	159 A4.000, 159 A4.046	1.8	1990.03 - 1996.08		3159.82D
1.8 i.e.	159 A4.000, 159 A4.046	1.8	1990.03 - 1996.08		410956.83D
1.8 i.e.	835 C2.000, 835 C4.000, 836 A5.000	1.8	1993.09 - 1996.08		3159.82D
1.9 D	160 A7.000, 149 A1.000	1.9	1991.07 - 1996.08		3431.80D
1.9 TD	160 A6.000, 160 B6.046, 160 D1.000	1.9	1990.05 - 1996.08	Ölkühlung	410692.71D
2.0 i.e.	159 A6.046	2.0	1990.10 - 1996.08	Motor no. →1518014	3159.82D
2.0 i.e.	159 A6.046	2.0	1990.11 - 1996.08	Motor no. 1518014→	410956.83D
<b>TIPO (160)</b>					
1.1	160 A3.000	1.1	1988.01 - 1991.10		3105.87D
1.4	160 A1.000	1.4	1987.07 - 1989.12		3109.87D
1.4 i.e.	160 A1.046, 836 A4.000	1.4	1989.05 - 1995.04		3109.87D
1.4 i.e.	159 A2.000	1.4	1989.05 - 1995.04	Motor no. →8742134	3109.87D
1.6	160 A2.000	1.6	1988.01 - 1991.10		3109.87D
1.6 i.e.	149 C2.046, 159 A3.046, 159 A3.048, 835 C1.000	1.6	1988.02 - 1995.04		3109.87D
1.6 SX DGT	159 A3.000	1.6	1989.05 - 1995.10	Motor no. →8742134	3109.87D
1.7 D	149 B4.000	1.7	1988.01 - 1995.10		3431.80D
1.8 i.e.	836 A5.000	1.8	1993.03 - 1995.04	Motor no. →1509143	3159.82D
1.8 i.e.	159 A4.000	1.8	1990.10 - 1995.04		3159.82D
1.8 i.e.	159 A4.046	1.8	1990.10 - 1993.06	Motor no. →1517343	3159.82D
1.8 i.e.	835 C2.000, 835 C4.000	1.8	1993.04 - 1995.04		3159.82D
1.9 D	149 A1.000, 160 A7.000	1.9	1991.07 - 1996.08		3431.80D
1.9 TD	160 A6.000, 160 A6.046, 160 B6.046, 160 D1.000	1.9	1990.09 - 1995.04	Ölkühlung	410692.71D
2.0	159 A5.046, 159 A6.046	2.0	1990.10 - 1992.10		3159.82D
2.0 i.e.	159 A6.046	2.0	1990.03 - 1995.04	Motor no. →1518014	3159.82D
2.0 i.e.	159 A6.046	2.0	1990.04 - 1995.04	Motor no. 1518014→	410956.83D
<b>ULYSSE (220)</b>					
1.8	LFW	1.8	1997.05 - 2002.08		3136.82D50
1.8	LFW	1.8	1997.05 - 2002.08	88° Variante	3136.88D50
1.9 TD	DHX (XUD9TF, L)	1.9	1995.02 - 2002.08		4446.83D
2.0	RFU (XU10J2C)	2.0	1994.06 - 2002.08	82° Variante	3136.82D50
2.0	RFU (XU10J2C)	2.0	1994.06 - 2002.08	88° Variante	3136.88D50
2.0 16V	RFV	2.0	1998.05 - 2000.09		4450.83D
2.0 16V	RFN (EW10J4)	2.0	2000.09 - 2002.08		3463.89D

# Thermostats

## FIAT

Engine

Ltr.

Year

Restriction\*

Thermostat

2.0 JTD	RHZ	2.0	1999.10 - 2002.08		4446.83D
2.0 Turbo (220.AD5)	RGX (XU10J2CTE)	2.0	1994.06 - 2002.08		3136.82D50
2.1 TD	P8C	2.1	1996.03 - 1999.10		4446.83D

### ULYSSE (179)

2.0	RFN (EW10J4)	2.0	2002.08 - 2011.06		3463.89D
2.0 JTD	RHM (DW10ATED4), RHW (DW10A-TED4)	2.0	2003.05 - 2006.08		4446.83D
2.2 JTD	4HW (DW12ATED4)	2.2	2002.08 - 2006.08		4446.83D

### UNO (146A/E)

1.3 Super Diesel	127 A5.000	1.3	1983.06 - 1992.03		3355.80D
1.3 Super Diesel	146 B1.000	1.3	1983.06 - 1992.03		3373.80D
1.4 Turbo i.e.	146 A8.000, 146 A8.046	1.4	1989.12 - 1996.12	Ölkühlung	410692.71D
45 0.9	146 A.000, 146 A1.000	0.9	1983.03 - 1992.09		3360.87D
45 1.0	156 A2.048, 156 A2.100	1.0	1986.06 - 1993.12		3105.87D
45 i.e. 1.0	156 A2.246	1.0	1984.04 - 1995.10		3105.87D
50 1.1	146 A4.044, 156 C.046	1.1	1986.01 - 1993.12		3105.87D
50 i.e. 1.1	146 C3.000	1.1	1992.06 - 1993.12		3105.87D
55 1.0		1.0	1993.11 - 2000.08		3105.87D
60 1.1	160 A3.000	1.1	1989.04 - 1992.12		3105.87D
60 Diesel 1.7	146 B2.000, 149 B3.000	1.7	1986.07 - 1993.12	ohne Klimaanlage	3431.80D
70 i.e. 1.4	160 A1.046	1.4	1989.09 - 1993.12		3109.87D
70 TD 1.4	146 B.000, 146 B3.000	1.4	1986.10 - 1990.10		3431.80D

### X 1/9 (128 AS)

1.5	138 AS.000, 138 BS.031	1.5	1978.11 - 1989.12		4033.82D
-----	------------------------	-----	-------------------	--	----------

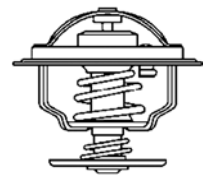

# FORD

	Engine	Ltr.	Year	Restriction*	Thermostat
<b>B-MAX</b>					
1.4		1.4	2012.10 -		4483.82D
1.6 Ti	IQJA	1.6	2012.10 -		4483.82D
<b>CAPRI III</b>					
1.3	J1E	1.3	1978.01 - 1985.06		3021.88D50
1.6	LCN	1.6	1978.01 - 1987.04		3021.88D50
2.0	NEN, OHC TL 20 H	2.0	1978.01 - 1985.12		3021.88D50
2.0	NYL	2.0	1978.01 - 1982.12	V6	4256.87D50
2.3 Super	YYN	2.3	1979.06 - 1985.12		4256.87D50
2.8 i Turbo	PYN	2.8	1982.01 - 1987.04		4256.87D50
2.8 Super Injection	PRN	2.8	1981.01 - 1987.04		4256.87D50
3.0	HYF	3.0	1978.01 - 1981.12		3004.88D1
<b>C-MAX</b>					
1.6	SHDA, HWDB, SHDB, HWDA, SHDC	1.6	2007.02 -		4483.82D
1.6 Ti	IQDB, IQDA, PNDA, XTDA	1.6	2010.12 -		4483.82D
1.8 TDCi	KKDA	1.8	2007.02 -		410131.88D
<b>COUGAR</b>					
2.0 16V	EDBB, EDBC, EDBD, EDBA	2.0	1998.08 - 2001.12		4270.88D
<b>ECONOVAN</b>					
1.4	UC	1.4	1986.03 - 1992.03		3119.88D3
<b>ENDEAVOUR (25N_)</b>					
2.5 TD	WL84	2.5	2003.05 -		4639.82D
<b>ESCORT III / IV 1980 → 1990</b>					
1.1	GLB, GMA, GPA, GSE, GSG	1.1	1981.03 - 1986.02		3021.88D50
1.3	JLA, JBA, JBB, JLB, JPA	1.3	1980.09 - 1990.10		3004.88D1
1.4	F6D, F6B, FUA, FUA, FUC	1.4	1985.10 - 1990.10		3021.88D50
1.4 i	F6D, F6B, FUC	1.4	1986.02 - 1990.07		3021.88D50
1.6	CHT 1600, LP1, LP2, LPA, LJB, LRB, LUA, LUC, LUG	1.6	1980.09 - 1990.07		3021.88D50
1.6 D	LTA, LTC	1.6	1984.02 - 1990.07		4256.87D50
1.6 i	L4B, LJB, LRA, LR1	1.6	1983.09 - 1990.05		3021.88D50
1.6 RS Turbo	LNA	1.6	1984.11 - 1985.12		3021.88D50
1.6 Turbo RS	LNB	1.6	1986.01 - 1990.07		3021.88D50
1.6 XR3i	LRA, LRB, LR1, LR2	1.6	1982.10 - 1990.07		3021.88D50
1.7 Turbo RS	0	1.7	1982.09 - 1986.02		3021.88D50
1.8 D	RTA, RTB	1.8	1988.07 - 1990.07		4256.87D50
RS 1600i	LUAE	1.6	1982.05 - 1985.12		3021.88D50
<b>ESCORT V / VI / VII / Classic 1990 →</b>					
1.3	J6A, J4B, JBD	1.3	1990.07 - 1999.02		3004.92D1
1.4	F4B, F6F, F6G, FUH	1.4	1993.08 - 1999.02		3021.88D50
1.4 i	F4B	1.4	1993.07 - 1995.01		3021.88D50
1.6	LJF, LUJ, LUK	1.6	1990.07 - 1992.12		3021.88D50
1.6 16V	L1E	1.6	1995.01 - 2000.07		4270.88D
1.6 16V XR3i	L1E, L1H	1.6	1992.12 - 1999.09		4270.88D
1.6 i 16V	L1E, L1K, L1H	1.6	1992.09 - 1999.02		4270.88D



# Thermostats

## FORD

Engine

Ltr.

Year

Restriction\*

Thermostat

1.8 16V	RDA, RKC	1.8	1992.02 - 1999.02		4270.88D
1.8 16V XR3i	RDA, RKC, RQB	1.8	1992.02 - 2000.08		4270.88D
1.8 D	RTH, RTF, RTE	1.8	1990.07 - 1999.02		4270.88D
1.8 i 16V	RDA, RQB	1.8	1992.09 - 1995.01		4270.88D
1.8 TD	RFS, RFD, RFK	1.8	1991.05 - 2000.07		410131.88D
1.8 Turbo D	RVA	1.8	1995.12 - 2001.06		4270.88D
1.8 XR3i 16V	RDA, RQB	1.8	1993.08 - 1995.01		4270.88D
RS 2000	N7A	2.0	1991.05 - 1998.10		3021.88D50

### EVEREST (25N\_)

2.5 TD	WL84	2.5	2003.05 -		4639.82D
--------	------	-----	-----------	--	----------

### FIESTA II (FBD)

1.0	TKB, TLB	1.0	1983.09 - 1989.11		3004.88D1
1.1	GSF, GSH, GLC	1.1	1983.09 - 1989.02		3004.88D1
1.3	JPC	1.3	1983.09 - 1987.01		3021.88D50
1.4	F6C, F6A, FUB, FUBA, FUD	1.4	1983.09 - 1989.11		3021.88D50
1.6 D	LTB	1.6	1984.04 - 1989.02		4256.87D50
1.6 XR2	LUB, LUD	1.6	1984.03 - 1989.02		3021.88D50

### FIESTA III (GFJ)

1.0	TLB	1.0	1989.03 - 1989.10		3004.88D1
1.0	TLB	1.0	1989.10 - 1995.12		3004.92D1
1.1	G6A, GUD, GUE	1.1	1989.03 - 1989.10		3004.88D1
1.1	G6A, GUD, GUE	1.1	1989.10 - 1995.12		3004.92D1
1.3	JBC	1.3	1989.03 - 1989.10		3004.88D1
1.3	JBC	1.3	1989.10 - 1992.12		3004.92D1
1.3	J6B	1.3	1991.05 - 1997.01		3004.92D1
1.4	F4A, F6E, FUG, FUJ	1.4	1989.03 - 1995.12		3021.88D50
1.6	LUH	1.6	1989.01 - 1994.01		3021.88D50
1.6 i 16V	L1G	1.6	1994.01 - 1995.12		4270.88D
1.6 Turbo	LHA	1.6	1990.03 - 1992.10		3021.88D50
1.6 XR2i	LJC, LJD	1.6	1989.03 - 1994.01	CVH	3021.88D50
1.8 16V	RDB	1.8	1992.02 - 1995.12		4270.88D
1.8 D	RTD, RTG, RTC	1.8	1989.03 - 1995.12		4270.88D
1.8 TD	RFL	1.8	1993.03 - 1995.12		4270.88D
1.8 XR2i 16V	RQC	1.8	1992.02 - 1995.12		4270.88D

### FIESTA IV (JA\_, JB\_)

1.0 i	ZH10JRB	1.0	1997.02 - 2002.01		3004.92D1
1.25 i 16V	DHG, DHB, DHC, DHE, DHF, DHA, DHD	1.25	1995.08 - 2002.01		4457.82D
1.3 i	J4R, J4C, J4L, J4J, J4Q, J4T, JJA, JJE, JJM, JJC, JJJ, JJK	1.3	1995.08 - 2002.01		3004.88D1
1.4 i 16V	FHE, FHA	1.4	1996.04 - 2002.01		4457.82D
1.6 16V Sport	L1V, L1T	1.6	2000.02 - 2002.01		4457.82D
1.8 D	RTK, RTJ	1.8	1995.08 - 2000.04		4270.88D
1.8 DI	RTP, RTN, RTQ	1.8	2000.04 - 2002.01		410131.88D

### FIESTA V (JH\_, JD\_)

1.0		1.0	2002.05 - 2008.03		3004.92D1
1.25 16V	FUJA, FUJB, M7JA, M7JB	1.25	2002.05 - 2004.03		4457.82D
1.25 16V	FUJA, FUJB, M7JA, M7JB	1.25	2004.03 -		4483.82D
1.4 16V	FXJB, FXJA	1.4	2001.11 - 2004.03		4457.82D

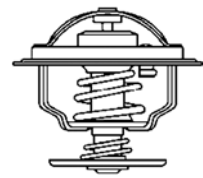

# FORD

	Engine	Ltr.	Year	Restriction*	Thermostat
1.4 16V	FXJB, FXJA	1.4	2004.03 -		4483.82D
1.6 16V	FYJA, FYJB	1.6	2001.11 - 2004.03		4457.82D
1.6 16V	FYJA, FYJB	1.6	2004.03 -		4483.82D
<b>FIESTA VI</b>					
1.25	SNJA, SNJB, STJA, STJB	1.25	2008.10 -		4483.82D
1.4	RTJA, RTJB, SPJA, SPJC	1.4	2009.01 -		4483.82D
1.6		1.6	2008.10 -		4483.82D
1.6 Ti	HXJB, HXJA, IQJA, U5JA	1.6	2008.10 -		4483.82D
<b>Fiesta COURIER (F3L, F5L)</b>					
1.3	J6B	1.3	1991.09 - 1996.02		3004.88D1
1.8 D	RTD, RTG, RTC	1.8	1991.09 - 1996.02		4270.88D
1.8 TD		1.8	1993.07 - 1995.08		4270.88D
<b>FIESTA Kasten (WFVT)</b>					
1.0	TKA	1.0	1977.10 - 1986.11		3004.88D1
1.1	GL1, GLA	1.1	1977.10 - 1986.11		3004.88D1
<b>FIESTA Kasten (FVD)</b>					
1.0	TKB	1.0	1983.08 - 1989.11		3004.88D1
1.8 D	RTD, RTG, RTC	1.8	1989.03 - 1995.12		4270.88D
1.8 TD		1.8	1993.07 - 1995.08		4270.88D
<b>FIESTA Courier (J5_, J3_)</b>					
1.3	J4C	1.3	1996.02 -		3004.88D1
1.4 i	FHA	1.4	1996.04 - 1999.10		4457.82D
1.8 D	RTK	1.8	1996.02 -		410131.88D
1.8 DI	RTP, RTN	1.8	2000.09 -		410131.88D
<b>FIESTA Kasten (JV_)</b>					
1.8 D	RTK, RTJ	1.8	1998.05 -		410131.88D
1.8 TD	RTP, RTN, RTQ	1.8	2000.03 -		410131.88D
<b>FIESTA Van</b>					
1.25	SNJA, SNJB	1.25	2009.01 -		4483.82D
<b>FOCUS (DAW, DBW, DFW, DNW)</b>					
1.4 16V	FXDA, FXDD, FXDC, FXDB	1.4	1998.10 - 2003.09		4457.82D
1.4 16V	FXDA, FXDD, FXDC, FXDB	1.4	2003.09 - 2004.11		4483.82D
1.6 16V	FYDH, FYDA, FYDB, FYDD, FYDC	1.6	1998.10 - 2003.09		4457.82D
1.6 16V	FYDH, FYDA, FYDB, FYDD, FYDC	1.6	2003.09 - 2004.11		4483.82D
1.8 16V	EYDD, EYDC, EYDE, EYDL, EYDF, EYDG, EYDB, EYDJ, EYDI	1.8	1998.10 - 2004.11		4270.88D
1.8 BiFuel		1.8	2003.02 - 2005.01		4270.88D
1.8 DI / TDDi	BHDB, BHDA	1.8	1998.08 - 2004.11		410131.88D
1.8 TDCi	F9DA, F9DB, FFDA	1.8	2001.03 - 2004.11		410131.88D
1.8 Turbo DI / TDDi	BHDB, BHDA, C9DA, C9DB, C9DC	1.8	1998.10 - 2005.03		410131.88D
2.0 16V	EDDC, EDDB, EDDD, EDDF	2.0	1998.10 - 2004.11		4270.88D
RS	HMDA	2.0	2002.10 - 2004.11		4270.88D
ST 170	ALDA	2.0	2002.03 - 2004.11		4270.88D

## FORD

	Engine	Ltr.	Year	Restriction*	Thermostat
<b>FOCUS II</b>					
1.4	ASDB, ASDA	1.4	2004.11 -		4483.82D
1.6	SHDA, HWDB, SHDB, HWDA, SHDC, SIDA	1.6	2004.11 -		4483.82D
1.6 Ti	HXDB, HXDA	1.6	2004.11 - 2005.12	3 Anschlüsse	4825.98D
1.6 Ti	HXDB, HXDA	1.6	2006.01 -	2 Anschlüsse	410016.98D
1.8 TDCi	KKDA, KKDB	1.8	2004.11 -		410131.88D
<b>FOCUS III</b>					
1.6	MUDA	1.6	2011.04 -		4483.82D
1.6 Ti	IQDB, PNDA, XTDA	1.6	2011.04 -		4483.82D
<b>FOCUS C-MAX</b>					
1.6	HWDB, HWDA	1.6	2003.10 - 2007.03		4483.82D
1.6 Ti	SIDA, HXDA	1.6	2004.08 - 2006.12	3 Anschlüsse	4825.98D
1.6 Ti	SIDA, HXDA	1.6	2006.01 - 2007.03	2 Anschlüsse	410016.98D
1.8 TDCi	KKDA	1.8	2005.01 - 2007.03		410131.88D
<b>FUSION</b>					
1.25	FUJA, FUJB	1.25	2004.08 -		4483.82D
1.4	FXJC, FXJB, FXJA, UTJA	1.4	2002.08 - 2004.03		4457.82D
1.4	FXJC, FXJB, FXJA, UTJA	1.4	2004.04 -		4483.82D
1.6	FYJA, FYJB	1.6	2002.08 - 2004.03		4457.82D
1.6	FYJA, FYJB	1.6	2004.04 -		4483.82D
<b>GALAXY</b>					
1.8 TDCi	FFWA, QYWA	1.8	2006.05 -		410131.88D
1.9 TDI		1.9	1995.03 - 2006.05		4264.87D
2.0 i	NSE, ZVSA	2.0	1995.11 - 2006.05		3021.88D50
2.3	Y5B	2.3	1996.09 - 2000.04		3021.88D50
2.3 16V	Y5B, E5SA	2.3	1997.01 - 2006.05		3021.88D50
2.8 V6	AYL	2.8	2000.04 - 2006.05		4123.80D
2.8 i V6	AAA, AMY	2.8	1995.11 - 2000.04		4123.80D
<b>GRAND C-MAX</b>					
1.6 Ti	IQDB, IQDA, PNDA	1.6	2010.12 -		4483.82D
<b>KA</b>					
1.3 TDCi	FD4	1.3	2010.11 -		411774.88D ▲
<b>KA (RB_)</b>					
1.0 i		1.0	1997.07 - 2008.11		3004.92D1
1.3 i	HCS Endura	1.3	1996.09 - 2008.11		3004.92D1
1.3 i	JJH, JJD, JJF, JJG, JJJ	1.3	1998.06 - 2008.11		3004.92D1
<b>MAVERICK</b>					
2.0 16V	YF	2.0	2001.02 -		4270.88D
2.4 i	KA-24, KA24-E	2.4	1993.02 - 1996.08		4637.76D
<b>ONDEO I (GBP, BNP)</b>					
1.6 i 16V	L1F, L1J	1.6	1993.02 - 1996.08		4270.88D
1.8 i 16V	RKA, RKB	1.8	1993.02 - 1996.08		4270.88D

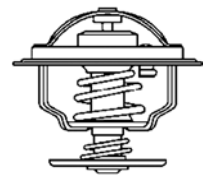

# FORD

	Engine	Ltr.	Year	Einschränkung Restriction*	Thermostat
1.8 TD	RFM, RFN	1.8	1993.06 - 1996.08		4270.88D
2.0 i 16V	NGA	2.0	1993.01 - 1996.08		4270.88D
<b>MONDEO II (BAP, BFP, BNP)</b>					
1.6 i	L1J	1.6	1996.09 - 2000.11		4270.88D
1.6 i 16V	L1N, L1L, L1Q	1.6	1998.05 - 2000.11		4270.88D
1.8 i	RKK, RKJ, RKB, RKF, RKH	1.8	1996.09 - 2000.11		4270.88D
1.8 TD	RFN	1.8	1996.09 - 2000.11		4270.88D
2.0 i	NGA, NGB, NGD, NGC	2.0	1996.09 - 2000.11		4270.88D
<b>MONDEO III (B4Y, B5Y, BWY)</b>					
2.0 16V DI / TDDi / TDCi	SDBA, D5BA	2.0	2000.11 - 2007.08		3497.88D
2.0 16V TDDi / TDCi	HJBA, HJBB, D6BA, HJBC	2.0	2000.11 - 2007.08		3497.88D
2.0 TDCi	N7BA, FMBA	2.0	2001.10 - 2007.08		3497.88D
2.2 TDCi	QJBA, QJBB, QJBC, QJBD	2.2	2004.09 - 2007.08		3497.88D
<b>MONDEO IV</b>					
1.6 Ti	KGBA, PNBA, RHBA	1.6	2007.03 -		4483.82D
1.8 TDCi	FFBA, KHBA, QYBA	1.8	2007.03 -		410131.88D
<b>ORION I / II (AFD, AFF)</b>					
1.3	JPA	1.3	1983.07 - 1986.03		3021.88D50
1.3	JLA, JBB, JLB	1.3	1985.12 - 1990.07		3004.88D1
1.3	JPA	1.3	1986.11 - 1988.07		3004.88D1
1.4	F6D, F6B, FUA, FUA, FUC	1.4	1985.12 - 1990.07		3021.88D50
1.6	LP1, LPA, LUC	1.6	1983.07 - 1990.07		3021.88D50
1.6 D	LTA, LTC	1.6	1984.02 - 1989.01		4256.87D50
1.6 i	L4B, LJB, LR1, LRA, LRB,	1.6	1983.07 - 1990.07		3021.88D50
1.8 D	RTA, RTB	1.8	1989.01 - 1990.07		4256.87D50
<b>ORION III (GAL)</b>					
1.3	J6A, J4B	1.3	1990.07 - 1993.12		3004.92D1
1.4	F6F, F6G, FUH	1.4	1990.07 - 1993.12		3021.88D50
1.6	LUJ, LUK	1.6	1990.07 - 1992.12		3021.88D50
1.6 i	LJF	1.6	1990.07 - 1992.09		3021.88D50
1.6 i 16V	L1E, L1K	1.6	1992.07 - 1993.12	Zetec	4270.88D
1.8 D	RTH, RTF, RTE	1.8	1990.11 - 1993.12		4270.88D
1.8 i 16V	RDA, RQB	1.8	1992.01 - 1993.12		4270.88D
1.8 TD	RFD, RFK	1.8	1992.03 - 1993.12		4270.88D
<b>P 100</b>					
1.6	LCR	1.6	1982.04 - 1987.09		3021.88D50
1.8 TD	RFA	1.8	1987.10 - 1992.12		4270.88D
2.0	NAE	2.0	1987.10 - 1992.12		3021.88D50
<b>PROBE II (ECP)</b>					
2.0 16V	FS	2.0	1993.10 - 1998.03		4639.82D
<b>PUMA (EC)</b>					
1.4 16V	FHD, FHF	1.4	1997.11 - 2000.10		4457.82D
1.6 16V	L1W	1.6	2000.08 - 2002.06		4457.82D
1.7 16V	MHB, MHA	1.7	1997.03 - 2002.06		4457.82D
ST 160		1.7	1999.06 - 2002.06		4457.82D

# FORD

Engine

Ltr.

Year

Restriction\*

Thermostat

## RANGER

2.5 D	WL	2.5	1999.10 - 2002.04		4639.82D
2.5 TD	WL-T	2.5	1999.10 - 2006.06		4639.82D
2.5 TDdi		2.5	2002.04 - 2005.09		4639.82D
2.9 D		2.9	1999.06 - 2002.02		4639.82D
2.2 TDCi	GBVAJPF, AJQJ, AJQW	2.2	2011.04 -		3497.88D
2.5 TDCi	WLAA	2.5	2006.05 -		4639.82D
3.0 TDCi	WEAT	3.0	2006.05 -		4639.82D
3.0 TDCi	SAFA	3.0	2011.04 -		3497.88D

## SCORPIO I (GAE, GGE)

1.8	REC	1.8	1985.04 - 1992.02		3021.88D50
2.0		2.0	1985.04 - 1989.08	OHC	3021.88D50
2.0		2.0	1985.04 - 1993.03	DOHC	3100.88D
2.0 i		2.0	1985.10 - 1992.02	OHC	3021.88D50
2.0 i		2.0	1989.05 - 1994.09	DOHC	3100.88D
2.4 i	ARC, ARD	2.4	1986.09 - 1994.10		4270.88D
2.5 D	STR	2.5	1985.12 - 1994.12		4147.80D
2.5 TD	SCB, SFA, SFB	2.5	1988.06 - 1994.09		4147.80D
2.8 i	PRE	2.8	1985.04 - 1986.11		4256.87D50
2.9 24V	BOA	2.9	1993.08 - 1994.09		4270.88D
2.9 i	BRC, BRD, BRE, BRF	2.9	1986.09 - 1994.12		4270.88D
2.9 i 24V	BOA	2.9	1991.04 - 1994.09		4270.88D

## SCORPIO II (GFR, GGR, GNR)

2.0 i		2.0	1994.10 - 1998.08	DOHC	3100.88D
2.0 i 16V		2.0	1994.10 - 1998.08	DOHC	3100.88D
2.3 i 16V	Y5A	2.3	1996.06 - 1998.08	DOHC	3100.88D
2.5 TD	SCC, VM	2.5	1994.10 - 1998.08		4158.80D
2.9 i	BRG	2.9	1995.02 - 1998.08		4270.88D
2.9 i 24V	BOB	2.9	1994.10 - 1998.08		4270.88D

## SIERRA

1.3	JCT	1.3	1982.08 - 1986.12		3021.88D50
1.6		1.6	1982.08 - 1993.02		3021.88D50
1.6 i	L6B	1.6	1989.10 - 1993.02		3021.88D50
1.8	REB	1.8	1984.10 - 1989.09	48 mm Ø	3021.88D50
1.8 TD	RFA, RFB, RFL	1.8	1988.08 - 1993.02		4270.88D
2.0		2.0	1982.08 - 1993.02	OHC	3021.88D50
2.0	NYT	2.0	1982.08 - 1984.10	V6	4256.87D50
2.0		2.0	1987.01 - 1993.02	DOHC	3100.88D
2.0 16V Cosworth		2.0	1990.01 - 1993.02	OHC	3021.88D50
2.0 16V Cosworth		2.0	1990.01 - 1993.02	DOHC	3100.88D
2.0 i		2.0	1987.01 - 1993.02	OHC	3021.88D50
2.0 i		2.0	1987.01 - 1993.02	DOHC	3100.88D
2.0 i DOHC	N9E	2.0	1991.12 - 1993.02		3100.88D
2.0 RS Cosworth	N5B	2.0	1987.11 - 1990.01	OHC	3021.88D50
2.0 RS Cosworth	N5B	2.0	1987.11 - 1990.01	DOHC	3100.88D
2.3	YYT	2.3	1982.08 - 1986.12		4256.87D50
2.3 D	YTR, YTT	2.3	1987.01 - 1993.02		4147.80D
2.8	PRG	2.8	1987.01 - 1988.08		4256.87D50
2.8 i	PR5, PR6, PR8, PRG	2.8	1982.08 - 1993.02		4256.87D50
2.8 XR	PRT	2.8	1985.02 - 1986.12		4256.87D50
2.8 XR4i	PR5, PR6, PRT	2.8	1982.08 - 1986.12		4256.87D50
2.9	B4B, B4C	2.9	1988.08 - 1993.02		4270.88D

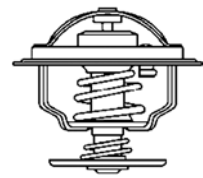

# FORD

	Engine	Ltr.	Year	Restriction*	Thermostat
2.9 i	B4B, B4C	2.9	1988.08 - 1993.02		4270.88D
2.9 i XR	B4A, B4B, B4C	2.9	1988.08 - 1993.02		4270.88D
<b>S-MAX</b>					
1.8 TDCi	FFWA, QYWA	1.8	2006.05 -		410131.88D
TOURNEO CONNECT	EYPC, EYPA, EYPD	1.8	2002.06 -		4270.88D
1.8 16V					
1.8 Di	BHPA, P7PA, P7PB, R2PA	1.8	2002.06 -		410131.88D
1.8 TDCi	RWPC, RWPA, RWPD	1.8	2006.08 -		410131.88D
1.8 Turbo Di	P9PB, P9PA, HCPB, RWPF, P9PC, R3PA, RWPE, HCPA, P9PD	1.8	2002.06 -		410131.88D
<b>TRANSIT (E_ _)</b>					
2.0		2.0	1991.09 - 1994.09	OHC	3021.88D50
2.0		2.0	1994.08 - 2000.03	DOHC	3100.88D
2.5 DI		2.5	1991.05 - 2000.03		4270.88D
2.5 TD		2.5	1991.05 - 2000.03		4270.88D
2.5 TDI		2.5	1994.06 - 2000.03		4270.88D
2.9 i	BRT	2.9	1991.01 - 1994.09		4270.88D
<b>TRANSIT (F_ _)</b>					
2.0 DI	ABFA, D3FA, F3FA	2.0	2000.08 - 2006.05		3497.88D
2.0 TDCi	FIFA	2.0	2002.08 - 2006.05		3497.88D
2.3 16V	E5FC, E5FA	2.3	2000.08 - 2006.05		3100.88D
2.4 DI	D2FA, D2FB, D2FE, D4FA, F4FA	2.4	2000.01 - 2006.05		3497.88D
2.4 TD	F4FA	2.4	2000.08 - 2003.08		3497.88D
2.4 TDCi	H9FA	2.4	2004.03 - 2006.05		3497.88D
2.4 TDdi	D4FA	2.4	2000.08 - 2003.08		3497.88D
2.4 TDE	DOFA, FXFA	2.4	2001.07 - 2006.05		3497.88D
<b>TRANSIT (T_ _)</b>					
1.6	LAT, L3C	1.6	1985.09 - 1992.09		3021.88D50
2.0	NAT, NAV	2.0	1985.09 - 1992.09	OHC	3021.88D50
2.5 D	4BA, 4CA, 4AB	2.5	1985.12 - 1992.09		4147.80D
2.5 DI	4BA, 4CA	2.5	1988.09 - 1992.09		4147.80D
<b>TRANSIT (V_ _)</b>					
1.6		1.6	1977.11 - 1986.10		3021.88D50
2.0	4RC	2.0	1977.11 - 1986.10	OHC / TL20	3021.88D50
2.4 D	4AA	2.4	1977.11 - 1986.10		3004.74
2.5 D		2.5	1983.10 - 1986.10		4147.80D
<b>TRANSIT 2007 →</b>					
2.2 TDCi		2.2	2006.04 -		3497.88D
2.4 TDCi		2.4	2006.04 -		3497.88D
3.2 TDCi		3.2	2007.09 -		3497.88D
<b>TRANSIT Bus</b>					
2.2 TDCi		2.2	2006.04 -		3497.88D
2.4 TDCi		2.4	2006.04 -		3497.88D
3.2 TDCi		3.2	2008.02 -		3497.88D

# Thermostats

## FORD

	Engine	Ltr.	Year	Restriction*	Thermostat
<b>TRANSIT CONNECT</b>					
1.8 16V	EYPC, EYPA, EYPD	1.8	2002.06 -		<b>4270.88D</b>
1.8 Di	BHPA, P7PA, P7PB, R2PA	1.8	2002.06 -		<b>410131.88D</b>
1.8 TDCi		1.8	2002.06 -		<b>410131.88D</b>
<b>TRANSIT TOURNEO</b>					
2.0	NSH	2.0	1994.11 - 2000.12		<b>3100.88D</b>
2.2 TDCi		2.2	2006.07 -		<b>3497.88D</b>
2.4 D	4HA	2.4	1994.08 - 2000.06		<b>410131.88D</b>
2.5 DI		2.5	1994.11 - 2000.12		<b>410131.88D</b>
2.5 TD		2.5	1994.11 - 2000.12		<b>410131.88D</b>

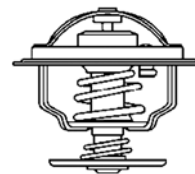

# HONDA

	Engine	Ltr.	Year	Restriction*	Thermostat
<b>ACCORD III (CA4, CA5)</b>					
1.6	A16A1	1.6	1985.11 - 1989.12		3119.82
2.0 EX	A20A1, A20A2	2.0	1985.11 - 1989.12		3119.82
2.0 EXi	A20A3, A20A4	2.0	1985.11 - 1989.12		3119.82
<b>ACCORD IV (CB, CC1)</b>					
2.0 16V	F20A3, F20A2, F20A6	2.0	1990.01 - 1993.03		410224.78D
2.0 i 16V	F20A4, F20A7, F20A8	2.0	1990.01 - 1993.09		410224.78D
2.2	F22A6	2.2	1991.10 - 1994.12		410224.78D
2.2 i 16V	F20Z3, F22A3, F22A7, F22A8	2.2	1990.01 - 1993.12		410224.78D
<b>ACCORD V (CC7, CD, CE, CF)</b>					
1.9 i	F18A3	1.9	1996.02 - 1998.10		410224.78D
2.0	F20B3	2.0	1993.09 - 1997.12		410224.78D
2.0 i	F20Z1, F20Z2	2.0	1993.03 - 1998.10		410224.78D
2.0 i 16V	F20B3	2.0	1993.09 - 1998.02		410224.78D
2.2 i	F22B5	2.2	1993.09 - 1998.02		410224.78D
2.2 i VTEC	F22Z2	2.2	1996.02 - 1998.10		410224.78D
<b>ACCORD VI (CG, CH, CK, CM)</b>					
1.6	D16B6, D16B7	1.6	1998.10 - 2002.12		410224.78D
1.6 i	D16B6	1.6	1998.10 - 2002.12		410224.78D
1.8 i	F18B2	1.8	1998.10 - 2002.12		410224.78D
2.0	F20B6, F20B7	2.0	1999.11 - 2002.12		410224.78D
2.0 i	F20B6	2.0	1998.10 - 2001.01		410224.78D
2.0 i 16V	F20B7, F20B5	2.0	1998.02 - 2003.06		410224.78D
2.2 Type-R	H22A7	2.2	1999.02 - 2002.12		410224.78D
2.3	F23A1, F23Z5	2.3	2000.11 - 2003.06		410224.78D
2.3 16 V	F23A7	2.3	1998.02 -		410224.78D
2.4 Vtec	K24A2	2.4	2003.09 - 2005.09		410226.78D
<b>ACCORD VII (CL, CM)</b>					
2.0	K20A6	2.0	2003.02 -		410226.78D
2.4	K24A	2.4	2003.02 - 2008.07		410226.78D
2.4 i 16V	K24A3	2.4	2003.02 -		410226.78D
2.4 Vtec	K24A	2.4	2003.02 - 2008.07		410226.78D
<b>ACCORD VIII (CU)</b>					
2.0 i	R20A3	2.0	2008.07 -		410226.78D
<b>ASCOT</b>					
1.8		1.8	1995.04 - 1997.10		410224.78D
2.2 EX	F22A7, F22A8	2.2	1990.11 - 1996.10		410224.78D
<b>AVANCIER</b>					
2.3	F23A	2.3	1999.09 - 2003.09		410224.78D
<b>CAPA</b>					
1.5	D15B	1.5	1998.01 - 2002.09		410224.78D
1.5 16V	D15B	1.5	1998.04 - 2002.09		410224.78D



# HONDA

Engine

Ltr.

Year

Restriction\*

Thermostat

## CITY

1.2	L12A2, L12A3	1.2	2003.05 -		410224.78D
1.3	D13B4	1.3	1997.02 - 2003.09		410224.78D
1.3	L13A1	1.3	2001.09 - 2004.10	82° Variante	410224.82D
1.3	L13A1	1.3	2003.05 - 2005.09	78° Variante	410224.78D
1.3	L13A3	1.3	2005.10 -		410224.78D
1.4 i-V TEC	L13Z1	1.4	2008.09 -		410224.78D
1.5	D15B7, L15A1	1.5	1997.02 - 2005.09		410224.78D
1.5 Vtec	L15A4	1.5	2000.08 -	78° Variante	410224.78D
1.5 Vtec	L15AV	1.5	2000.08 -	82° Variante	410224.82D

## CIVIC II

1.4 i 16V	D14A1	1.4	1988.01 - 1992.12		410224.78D
1.5 i 16V	D15B2	1.5	1988.01 - 1991.11		410224.78D
1.6	D16A, D16A7	1.6	1988.01 - 1992.12		410224.78D
1.6 i 16V	D16A6	1.6	1988.01 - 1995.02		410224.78D
1300	EN1	1.3	1979.09 - 1983.09		3119.82

## CIVIC III

1.2	ZA2, D12B1	1.2	1984.01 - 1987.10		4269.78D
1.3	EV2	1.3	1983.10 - 1987.10		4269.78D
1.5	EW2	1.5	1983.10 - 1987.10		4269.78D
1.5 GT / GTI	EW3, EW4	1.5	1985.01 - 1987.10		4269.78D

## CIVIC IV

1.2	D12B1	1.2	1988.01 - 1991.12		4269.78D
1.3	D13B1	1.3	1987.10 - 1989.12		4269.78D
1.3 16V	D13B2	1.3	1989.09 - 1991.09		4269.78D
1.4	D14A1	1.4	1987.10 - 1989.12		4269.78D
1.5	D15B1	1.5	1988.01 - 1989.12		4269.78D
1.5 i 16V	D15B2	1.5	1987.10 - 1991.09		4269.78D
1.6	D16Z5	1.6	1988.01 - 1989.12		4269.78D
1.6 16V	D16A, D16Z	1.6	1987.09 - 1991.09		4269.78D
1.6 i 16V Vtec	B16A1	1.6	1989.10 - 1991.09		4269.78D

## CIVIC V

1.3	D13B2	1.3	1992.01 - 1992.12		410224.78D
1.3 16V	D13B2	1.3	1991.10 - 1995.11		410224.78D
1.5	D15B, D15Z	1.5	1992.01 - 1995.12		410224.78D
1.5 i	D15B7	1.5	1993.08 - 1995.11		410224.78D
1.5 i 16V	D15B, D15Z	1.5	1991.10 - 1995.11		410224.78D
1.6	D16A, D16Z	1.6	1992.01 - 1995.10		410224.78D
1.6 16V Vtec	D16Z6, D16Z7	1.6	1991.10 - 1995.11		410224.78D
1.6 i	D16Y7	1.6	1994.01 - 1995.11		410224.78D
1.6 i Vtec	B16A2, D16Y6, D16Z9	1.6	1994.01 - 1996.03		410224.78D
1.6 Vtec	B16A1	1.6	1991.10 - 1995.05		410224.78D
1.6 VTi	B16A2	1.6	1991.10 - 1995.11		410224.78D
1.6 VTi 16V	B16A2	1.6	1991.10 - 1995.11		410224.78D

## CIVIC VI

1.4	D14A4, D14Z4	1.4	1995.11 - 2001.02		410224.78D
1.4 16V	D14A7, D14A8	1.4	1998.04 - 2001.02		410224.78D
1.4 i	D14A	1.4	1994.09 - 2001.02		410224.78D
1.5	D15Z3	1.5	1995.11 - 1996.12		410224.78D

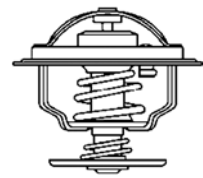

# HONDA

	Engine	Ltr.	Year	Restriction*	Thermostat
1.5 16V	D15Z8	1.5	1997.01 - 2001.02		410224.78D
1.5 i	D15B2, D15Z6	1.5	1995.10 - 2001.03		410224.78D
1.5 i Vtec-E	D15Z3	1.5	1994.09 - 1997.01		410224.82D
1.6	D16Y2, D16Y7, D16W4	1.6	1995.10 - 2000.10		410224.78D
1.6 16V	D16B2, D16W4	1.6	1997.01 - 2001.02		410224.78D
1.6 i	D16Y3	1.6	1994.09 - 1997.01		410224.78D
1.6 i	D16Y5, D16Y7	1.6	1995.11 - 2001.02		410224.78D
1.6 i Vtec	B16A2, D16Y2, D16Y6, D16Y8, D16Z7	1.6	1994.09 - 2001.02		410224.78D
1.6 VTEC Type R		1.6	1997.08 - 2000.09		410224.78D
1.6 VTi	B16A2	1.6	1995.11 - 2001.02		410224.78D
1.7	D17A6	1.7	1997.11 - 2001.03		410224.78D
1.8 16V	B18C4	1.8	1997.01 - 2001.02		410224.78D
<b>CIVIC VII</b>					
1.3	LDA1	1.3	2004.01 - 2005.09		410224.78D
1.4	D14Z5	1.4	2000.11 - 2005.09		410224.78D
1.4 i	D14Z5, D14Z6	1.4	2001.02 - 2005.09		410224.78D
1.6	D16V1, R16A1	1.6	2001.02 - 2005.09		410224.78D
1.6 i	D16V1	1.6	2001.02 - 2005.12		410224.78D
1.7	D17A6	1.7	2001.02 - 2005.09		410224.78D
1.7 i	D17A8	1.7	2001.05 - 2005.12		410224.78D
1.7 i VTEC	D17A5, D17A9	1.7	2001.05 - 2005.12		410224.78D
2.0 i Sport	K20A3	2.0	2001.09 - 2005.09		410225.78D
2.0 Type-R	K20A2	2.0	2001.09 - 2005.09		410225.78D
<b>CIVIC VIII</b>					
1.3 Hybrid	LDA2	1.3	2006.01 - 2012.02		410224.82D
1.4	L13A7	1.4	2006.01 -		410224.82D
1.8	R18A1, R18A2	1.8	2005.09 - 2012.02		410224.78D
2.0	K20Z4	2.0	2006.12 -		410226.78D
Type R	K20Z4	2.0	2006.09 -		410226.78D
<b>CONCERTO</b>					
1.4	D14A1, D14A8	1.4	1989.08 - 1992.10		410224.78D
1.5 i 16V	D15B2	1.5	1989.08 - 1995.05		410224.78D
1.6	D16A9	1.6	1989.10 - 1992.10		410224.78D
1.6 16V	D16Z2	1.6	1989.08 - 1995.03		410224.78D
1.6 i 16V	D16A8, D16Z2	1.6	1989.08 - 1995.03		410224.78D
<b>CR-V I (RD)</b>					
2.0	B20Z1	2.0	1999.04 - 2002.02		410224.78D
2.0 16V	B20B, B20Z1	2.0	1995.10 - 2002.02		410224.78D
<b>CR-V II</b>					
2.0	K20A4, K20A5	2.0	2002.03 - 2006.09		410225.78D
2.4 Vtec	K24A1	2.4	2001.09 - 2006.09		410225.78D
<b>CR-V III</b>					
2.0 i	R20A2	2.0	2007.01 -		410224.78D
2.4	K24A1, K24Z1	2.4	2006.09 -		410226.78D
2.4 i-VTEC	K24Z4, K24Z1	2.4	2006.10 -		410226.78D

# Thermostats

## HONDA

Engine

Ltr.

Year

Restriction\*

Thermostat

### CR-V IV (RE)

2.0		2.0	2012.01 -		410224.82D
2.4		2.4	2012.01 -		410226.78D

### CR-Z (ZF1)

1.5 Hybrid	LEA1, LEA3	1.5	2010.06 -		410224.78D
------------	------------	-----	-----------	--	------------

### CRX I (AF, AS)

1.3	EV2	1.3	1983.10 - 1987.10		410224.78D
1.5 i	EW3	1.5	1983.10 - 1986.11		410224.78D
1.6 i 16V	ZC1	1.6	1986.03 - 1987.10		410224.78D

### CRX II (ED, EE)

1.4	D14A1	1.4	1990.01 - 1991.12		410224.78D
1.6 i 16V	D16A, D16Z	1.6	1987.10 - 1992.02		410224.78D
1.6 i 16V Vtec	B16A1	1.6	1989.10 - 1992.02		410224.78D

### CRX III (EH, EG)

1.5	D15B7	1.5	1994.01 - 1998.04		410224.78D
1.6 ESi	D16Y8, D16Z6	1.6	1992.03 - 1998.12		410224.78D
1.6 i VTi	B16A2	1.6	1992.03 - 1998.12		410224.78D

### DOMANI

1.4	B13B	1.4	1994.11 - 1997.12		410224.78D
1.5	D15B3	1.5	1992.10 - 2000.09		410224.78D
1.6	D16Z2	1.6	1988.11 - 1997.12		410224.78D
1.8	B18B6	1.8	1994.10 - 2000.09		410224.78D

### FIT

1.3	L13A1	1.3	2003.05 -		410224.82D
1.5	L15A1, L15A2	1.5	2003.05 -		410224.82D

### FR-V

1.7	D17A2	1.7	2004.08 -		410224.78D
1.8	R18A1	1.8	2007.01 -		410224.82D
2.0	K20A9	2.0	2005.02 -		410225.78D

### HR-V (GH)

1.6 16V	D16W1, D16W5	1.6	1999.03 -		410224.78D
---------	--------------	-----	-----------	--	------------

### INTEGRA

1.6	B16A	1.6	1989.09 - 1993.08		410224.78D
1.6 Vtec	B16A	1.6	1989.09 - 1993.08		410224.78D
1.8	F18A2	1.8	1989.09 - 1993.08		410224.78D
1.8 Type-R	B18C6	1.8	1997.11 - 2001.10		410224.78D
2.0	K20A3	2.0	2002.02 -		410225.78D
2.0 16V Type-R	K20Z1	2.0	2002.02 -		410224.78D

### INSIGHT (ZE\_)

1.3 Hybrid	LDA3	1.3	2009.04 -		410224.78D
------------	------	-----	-----------	--	------------

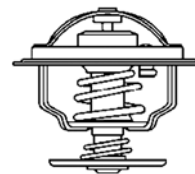

# HONDA

	Engine	Ltr.	Year	Restriction*	Thermostat
<b>JAZZ II</b>					
1.2	L12A1	1.2	2002.03 - 2008.07		410224.82D
1.4	L13A1	1.4	2002.03 - 2008.07		410224.82D
<b>JAZZ III</b>					
1.2	L12B1	1.2	2008.07 -		410224.82D
1.4 i	L13Z1	1.4	2008.07 -		410224.82D
<b>LEGEND I (HS, KA)</b>					
2.5 i	C25A1, C25A2	2.5	1986.01 - 1988.06		4269.78D
2.7 i 24V	C27A1	2.7	1987.10 - 1990.12		4269.78D
<b>LOGO (GA3)</b>					
1.3	D13B7	1.3	1999.03 - 2002.03		410224.78D
<b>PRELUDE I Coupe (SN)</b>					
1.6	EL14, EL	1.6	1978.11 - 1982.10		3119.82
<b>PRELUDE II (AB)</b>					
1.8	ET2, ET3, ET4	1.8	1983.11 - 1987.04		3119.82
<b>PRELUDE IV (BB)</b>					
2.0 i 16V	F20A4	2.0	1992.02 - 1996.09		410224.78D
<b>PRELUDE V (BB)</b>					
2.0 16V	F20A4	2.0	1996.10 - 2000.10		410224.78D
<b>QUINTET (SU)</b>					
1.6 EX	EL	1.6	1980.02 - 1984.12		3119.82
<b>SHUTTLE (RA)</b>					
2.2 16V	F22B8	2.2	1994.10 - 1998.02		410224.78D
2.3 16V	F23A7	2.3	1997.10 - 2004.06		410224.78D
<b>STEPWAGON</b>					
2.0	K20A9	2.0	2000.10 - 2005.09		410224.78D
<b>STREAM (RN)</b>					
1.7 16V	D17A2	1.7	2001.05 -		410224.78D
2.0 16V	K20A1	2.0	2001.05 -		410225.78D
<b>TORNEO</b>					
1.6	D16B6	1.6	1999.10 - 2002.09		410224.78D
1.8	F18B	1.8	1999.10 - 2002.09		410224.78D
2.0	F20B, F20Z2	2.0	1994.04 - 2003.09		410224.78D
2.0 SiR	F20B4	2.0	1999.10 - 2003.09		410224.78D
2.0 VTS	F20B1	2.0	1998.01 - 2003.09		410224.78D

# HYUNDAI

Engine

Ltr.

Year

Restriction\*

Thermostat

## ACCENT (X-3)

1.3	G4EH	1.3	1994.10 - 2000.01		410351.88D
1.3 i 12V	G4EH	1.3	1994.10 - 2000.01		410351.88D
1.5 i 12V	G4EK	1.5	1994.10 - 2000.01		410351.88D
1.5 i 16V	G4ER	1.5	1995.10 - 2000.01		410348.82D

## ACCENT (LC)

1.3	G4EA, G4EH	1.3	2000.04 - 2005.11		410351.88D
1.5	G4FK, G4EB, G4EC-G	1.5	1999.09 - 2005.11		410348.82D
1.6	G4ED-G	1.6	2002.12 - 2005.11		410348.82D

## COUPE (RD)

1.6 16V	G4GR	1.6	1998.03 - 2002.04		410348.82D
1.6 i 16V	4G61	1.6	1996.12 - 2002.04		410348.82D
2.0 16V	G4DF, G4GF	2.0	1996.08 - 2002.04		410348.82D

## COUPE (GK)

2.0	G4GC-G	2.0	2002.03 - 2009.08		410348.82D
-----	--------	-----	-------------------	--	------------

## ELANTRA (XD)

1.6	G4ED-G	1.6	2000.06 - 2006.07		410348.82D
1.8	G4BB	1.8	2000.06 - 2006.07		410348.82D
2.0	G4GC, G4GC-G	2.0	2000.06 - 2006.07		410348.82D

## GETZ (TB)

1.3, 1.3 i	G4EA	1.3	2002.09 - 2005.09		410351.88D
1.6	G4ED-G	1.6	2002.09 - 2005.09		410348.82D

## LANTRA I (J-1)

1.5 i.e.	G15B, G4DJ	1.5	1990.10 - 1995.11		3119.82
1.6 i.e. 16V	G4CR	1.6	1990.10 - 1995.11		3119.82
1.8 i.e. 16V	G4CN	1.8	1990.10 - 1995.11		3119.82

## LANTRA II (J-2)

1.6 16V	4G61	1.6	1995.11 - 2000.10		410348.82D
1.6 i	G4GR	1.6	1995.11 - 2000.10		410348.82D
1.8 16V	G4GM	1.8	1995.11 - 2000.10		410348.82D
1.9 D	DJY	1.9	1998.03 - 2000.10		4446.83D
2.0 16V	G4GF	2.0	1996.08 - 2000.10		410348.82D

## MATRIX (FC)

1.6	G4ED-G	1.6	2001.06 - 2010.08		410348.82D
1.8	G4GB-G	1.8	2000.12 - 2010.08		410348.82D

## PONY/EXCEL (X-2)

1.5 / 1.5 i	G15B, G4DJ	1.5	1989.10 - 1995.01		3119.82
-------------	------------	-----	-------------------	--	---------

## SONATA II (Y-2)

2.0 i	G4CP-U	2.0	1991.01 - 1993.10		3119.82
2.0 i 16V	G4CP-D	2.0	1991.01 - 1993.10		3119.82

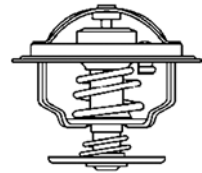

# HYUNDAI

	Engine	Ltr.	Year	Restriction*	Thermostat
<b>STELLAR (F31_, SF2_)</b>					
1.6	G32B	1.6	1983.10 - 1991.12		<b>3119.82</b>
<b>TRAJET (FO)</b>					
2.0	G4JP-G, G4GC-G	2.0	2000.03 - 2008.07		<b>410348.82D</b>
2.0 CRDi	D4EA	2.0	2001.04 - 2008.07		<b>410348.82D</b>

# Thermostats

## INNOCENTI

Engine

Ltr.

Year

Restriction\*

Thermostat

### MINI

0.55	Daihatsu-EB	0.55	1987.01 - 1991.12		<b>3119.82</b>
0.65		0.65	1984.01 - 1987.12		<b>3119.82</b>
0.65		0.65	1990.01 - 1995.01		<b>3119.82</b>
1.0		1.0	1974.05 - 1982.02		<b>3044.80</b>
1.0	BLM C 99 H	1.0	1974.05 - 1982.02		<b>3044.80</b>
1.0	BLM C 99 H	1.0	1985.10 - 1991.10		<b>3044.80</b>
1.3	BLM C 12 H	1.3	1976.08 - 1982.02		<b>3044.80</b>
1.3 De Tomaso	BLM C 12 HH	1.3	1976.08 - 1982.02		<b>3044.80</b>

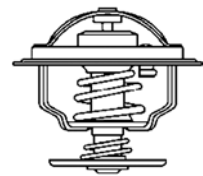

# IVECO

	Engine	Ltr.	Year	Restriction*	Thermostat
<b>DAILY I</b>					
30- 8	8140.61.200	2.5	1978.01 - 1989.12		<b>4151.79D</b>
35- 8	8140.61.200	2.5	1978.01 - 1989.12		<b>4151.79D</b>
35-10	8140.21.200	2.5	1985.01 - 1989.12	Motor no. 976562 →	<b>4151.79D</b>
40- 8	8140.61.200	2.5	1983.01 - 1989.06		<b>4151.79D</b>
40-10	8140.27 S	2.5	1985.01 - 1989.12		<b>4174.79D</b>
45-10	8140.21.200	2.5	1985.01 - 1989.12	Motor no. 976562 →	<b>4151.79D</b>
49-10	8140.21.200	2.5	1985.01 - 1989.12	Motor no. 976562 →	<b>4151.79D</b>
<b>DAILY II</b>					
30- 8	8140.07, 8140.63, 8140.67	2.5	1989.01 - 1998.08		<b>4174.79D</b>
30-10	8140.23.	2.8	1997.01 - 1999.05		<b>4174.79D</b>
35- 8	8140.07, 8140.63, 8140.67	2.5	1989.01 - 1998.08		<b>4174.79D</b>
35-10	8140.23, 8140.47, 8140.47, 8140.97	2.8	1989.01 - 1998.08		<b>4174.79D</b>
35-12	8140.43, 8140.47	2.8	1990.01 - 1999.05		<b>4174.79D</b>
40-10	8140.23, 8140.27	2.8	1990.01 - 1999.05		<b>4174.79D</b>
40-12	8140.43, 8140.47.2700	2.5	1990.10 - 1996.04		<b>4174.79D</b>
45-10	8140.23, 8140.27.2720	2.5	1989.01 - 1999.05		<b>4174.79D</b>
45-12	8140.43, 8140.47	2.8	1990.06 - 1999.05		<b>4174.79D</b>
49-10	8140.23, 8140.27, 8140.47	2.8	1989.01 - 1999.05		<b>4174.79D</b>
49-12	8140.43, 8140.47	2.8	1990.06 - 1999.05		<b>4174.79D</b>
59-12	8140.43, 8140.47	2.8	1991.05 - 1999.05		<b>4174.79D</b>
<b>DAILY III</b>					
29 L 9	8140.43, 8140.63.	2.8	1999.05 - 2006.04	79° Variante	<b>4174.79D</b>
29 L 9	8140.43, 8140.63.	2.8	2001.11 - 2006.04	82° Variante	<b>4174.82D</b>
29 L 9	8140.43, 8140.63.	2.8	2001.11 - 2006.04	88° Variante	<b>4174.88D ▲</b>
29 L 10	F1AE0481A	2.3	2002.09 -		<b>3171.82D</b>
29 L 11	8140.43	2.8	1999.05 -	82° Variante	<b>4174.82D</b>
29 L 11	8140.43	2.8	1999.05 -	88° Variante	<b>4174.88D ▲</b>
29 L 12	F1AE0481B	2.3	2002.09 -		<b>3171.82D</b>
29 L 13	8140.43S	2.8	2001.05 -	88° Variante	<b>4174.79D</b>
29 L 13	8140.43S	2.8	2001.05 -	82° Variante	<b>4174.82D</b>
29 L 13	8140.43S	2.8	2001.05 -	88° Variante	<b>4174.88D ▲</b>
29 L 14	F1AE0481M	2.3	2005.01 - 2006.04		<b>3171.82D</b>
35 C 9, 35 S 9	8140.43, 8140.63	2.8	1999.05 - 2006.04	79° Variante	<b>4174.79D</b>
35 C 9, 35 S 9	8140.43, 8140.63	2.8	1999.05 - 2006.04	82° Variante	<b>4174.82D</b>
35 C 9, 35 S 9	8140.43, 8140.63	2.8	1999.05 - 2006.04	88° Variante	<b>4174.88D ▲</b>
35 C 10, 35 S 10	F1AE0481A	2.3	2002.09 -		<b>3171.82D</b>
35 C 11, 35 S 11	8140.43C	2.8	1999.05 -	82° Variante	<b>4174.82D</b>
35 C 11, 35 S 11	8140.43C	2.8	1999.05 -	88° Variante	<b>4174.88D ▲</b>
35 C 12, 35 S 12	F1AE0481B	2.3	2002.09 -		<b>3171.82D</b>
35 C 13, 35 S 13	8140.43S	2.8	1999.05 -	79° Variante	<b>4174.79D</b>
35 C 13, 35 S 13	8140.43S	2.8	1999.05 -	82° Variante	<b>4174.82D</b>
35 C 13, 35 S 13	8140.43S	2.8	1999.05 -	88° Variante	<b>4174.88D ▲</b>
35 C 14	F1CE0481A	3.0	2004.09 - 2006.04		<b>3169.79D</b>
35 C 14, 35 S 14	F1AE0481M	2.3	2005.01 - 2006.04		<b>3171.82D</b>
35 C 15	8140.43N	2.8	2001.11 -	82° Variante	<b>4174.82D</b>
35 C 15	8140.43N	2.8	2001.11 -	88° Variante	<b>4174.88D ▲</b>
35 C 15, 35 S 15	8140.43N	2.8	2002.11 -	82° Variante	<b>4174.82D</b>
35 C 15, 35 S 15	8140.43N	2.8	2002.11 -	88° Variante	<b>4174.88D ▲</b>
35 C 17, 35 S 17	F1CE0481B	3.0	2005.01 - 2006.04		<b>3169.79D</b>
35 S 10	F1AE0481A	2.3	2002.09 -		<b>3171.82D</b>
40 C 13	8140.43S	2.8	1999.05 - 2006.04	82° Variante	<b>4174.82D</b>
40 C 13	8140.43S	2.8	1999.05 - 2006.04	88° Variante	<b>4174.88D ▲</b>



# Thermostats

## IVECO

	Engine	Ltr.	Year	Restriction*	Thermostat
40 C 14	F1CE0481A	3.0	2004.09 - 2006.04		3169.79D
40 C 14	F1AE0481M	2.3	2005.01 - 2006.04		3171.82D
40 C 15	8140.43N	2.8	2001.11 - 2006.04	82° Variante	4174.82D
40 C 15	8140.43N	2.8	2001.11 - 2006.04	88° Variante	4174.88D ▲
40 C 17, 40 S 17	F1CE0481B	3.0	2005.01 - 2006.04		3169.79D
50 C 11	8140.43C	2.8	1999.05 -	82° Variante	4174.82D
50 C 11	8140.43C	2.8	1999.05 -	88° Variante	4174.88D ▲
50 C 13	8140.43S	2.8	1999.05 -	79° Variante	4174.79D
50 C 13	8140.43S	2.8	1999.05 -	82° Variante	4174.82D
50 C 13	8140.43S	2.8	1999.05 -	88° Variante	4174.88D ▲
50 C 14	F1CE0481A	3.0	2004.09 - 2006.04		3169.79D
50 C 15	8140.43N	2.8	2001.01 - 2006.04	82° Variante	4174.82D
50 C 15	8140.43N	2.8	2001.01 - 2006.04	88° Variante	4174.88D ▲
50 C 17	F1CE0481B	3.0	2004.09 - 2006.04		3169.79D
65 C 14	F1C	3.0	2004.09 - 2006.04		3169.79D
65 C 14	F1A	3.0	2004.09 - 2006.04		3171.82D
65 C 15	8140.43N	2.8	2001.11 - 2006.04	82° Variante	4174.82D
65 C 15	8140.43N	2.8	2001.11 - 2006.04	88° Variante	4174.88D ▲
65 C 17	F1CE0481B	3.0	2004.09 - 2006.04		3169.79D

## DAILY IV

29 L 10	F1AE0481FA	2.3	2006.05 -		410937.82D ▲
29 L 12	F1AE0481GA	2.3	2006.05 -		410937.82D ▲
29 L 14	F1AE0481HA	2.3	2006.05 -		410937.82D ▲
35 C 10, 35 S 10	F1AE0481FA	2.3	2006.05 -		410937.82D ▲
35 C 11, 35 S 11	F1AE0481FA	2.3	2007.07 -		410937.82D ▲
35 C 12, 35 S 12	F1AE0481GA	2.3	2006.05 -		410937.82D ▲
35 C 13, 35 S 13	F1AE0481GA	2.3	2007.07 -		410937.82D ▲
35 C 14, 35 S 14	F1AE0481HA	2.3	2006.05 -		410937.82D ▲
35 C 15	F1CE0481FA	3.0	2006.05 -		410081.79D
35 C 18, 35 S 18	F1CE0481HA	3.0	2006.05 -		410081.79D
40 C 10	F1AE0481FA	2.3	2006.05 -		410937.82D ▲
40 C 11	F1AE0481FA	2.3	2007.07 -		410937.82D ▲
40 C 12	F1AE0481GA	2.3	2006.05 -		410937.82D ▲
40 C 13	F1AE0481GA	2.3	2007.07 -		410937.82D ▲
40 C 15	F1CE0481FA	3.0	2006.05 -		410081.79D
40 C 18	F1CE0481HA	3.0	2006.05 -		410081.79D
45 C 15	F1CE0481FA	3.0	2006.05 -		410081.79D
45 C 18	F1CE0481HA	3.0	2006.05 -		410081.79D
50 C 15	F1CE0481FA	3.0	2006.05 -		410081.79D
50 C 18	F1CE0481HA	3.0	2006.05 -		410081.79D
60 C 15	F1CE0481FA	3.0	2006.05 -		410081.79D
60 C 18	F1CE0481HC	3.0	2006.05 -		410081.79D
65 C 15	F1CE0481FA	3.0	2006.05 -		410081.79D
65 C 18	F1CE0481HC	3.0	2006.05 -		410081.79D

## MASSIF

3.0 HPI	F1CE0481FA	3.0	2008.10 -		3169.79D
3.0 HPT	F1CE0481HA	3.0	2008.10 -		3169.79D

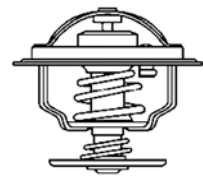

# JEEP

	Engine	Ltr.	Year	Einschränkung Restriction*	Thermostat
<b>CHEROKEE (XJ)</b>					
2.1 D	J8S 742	2.0	1986.10 - 1992.09		<b>4147.80D</b>
2.1 TD	J8S	2.0	1984.10 - 2001.09		<b>4147.80D</b>
2.5	EPE	2.5	1995.10 - 2001.09		<b>4158.80D</b>
2.5 i	EPE, HX	2.5	1991.12 - 2001.09		<b>3000.83</b>
2.5 TD	ENC	2.5	1988.01 - 2001.09		<b>4158.80D</b>
4.0 i	ERH, MX	4.0	1988.01 - 2001.09		<b>3000.83</b>
CJ5 - CJ8					
2.1 D	J8S-800	2.0	1983.01 - 1987.12		<b>4147.80D</b>
<b>COMMANDER (XK)</b>					
3.0 CRD	EXL	3.0	2006.04 - 2010.12		<b>4630.87D ▲</b>
<b>GRAND CHEROKEE I (Z)</b>					
2.5 TD	M51, M52	2.5	1995.10 - 1999.04		<b>4158.80D</b>
4.0 i (Z)	S01	4.0	1995.10 - 1999.04		<b>3000.83</b>
4.0 i (ZJ)	MX	4.0	1991.09 - 1999.04		<b>3000.83</b>
4.0 i (ZJ)	ERH	4.0	1991.09 - 1999.04		<b>3000.83</b>
5.2 (Z)	Y01	5.2	1995.10 - 1999.04		<b>3000.90</b>
5.2 i (ZJ)	Y	5.2	1992.09 - 1999.04		<b>3000.90</b>
5.2 i (ZJ)	ELF	5.2	1992.01 - 1999.04		<b>3000.90</b>
5.9 i		5.9	1997.08 - 1999.04		<b>3000.90</b>
<b>GRAND CHEROKEE II (WJ, WG)</b>					
3.1 TD	EXA	3.1	1999.04 - 2001.12		<b>4158.80D</b>
<b>GRAND CHEROKEE III (WH, WK)</b>					
3.0 CRD	EXL	3.0	2005.06 - 2010.12		<b>4630.87D ▲</b>
<b>WRANGLER I (YJ, SJ_)</b>					
2.5	EPE	2.5	1988.01 - 1996.08		<b>3000.83</b>
4.0	ERH	4.0	1991.12 - 1996.08		<b>3000.83</b>
<b>WRANGLER II (TJ)</b>					
2.5	P00	2.5	1996.08 - 2007.04		<b>3000.83</b>
4.0	S01	4.0	1996.08 - 2007.04		<b>3000.83</b>

# Thermostats

## KIA

	Engine	Ltr.	Year	Restriction*	Thermostat
<b>BESTA</b>					
2.2 D	R2	2.2	1996.02 -		3498.88D
<b>CARENS I (FC)</b>					
1.8 i	T8	1.8	2000.11 - 2002.07		410352.88D
<b>CARENS II (FJ)</b>					
1.6	GA6D	1.6	2002.07 -		410352.88D
1.8		1.8	2002.07 -		410352.88D
<b>CLARUS (K9A, GC)</b>					
1.8 i 16V	T8	1.8	1996.07 -		410352.88D
2.0 i 16V	FE (16V)	2.0	1996.07 -		3498.88D
<b>PRIDE</b>					
1.1 i	B1	1.1	1991.01 -		410352.82D
1.3		1.3	1999.08 -		410352.82D
1.3 16V	B3	1.3	1990.01 -		410352.82D
1.3 i		1.3	1990.01 -		410352.82D
<b>RETONA (CE)</b>					
2.0 16V	FE (16V)	2.0	2000.05 -		3498.88D
2.0 TD	RF	2.0	1999.06 -		3468.88D
<b>RIO (DC_)</b>					
1.3		1.3	2000.08 - 2005.02		410352.88D
<b>SEPHIA (FA)</b>					
1.5 i	B5	1.5	1996.02 - 1997.10		410352.82D
1.6 i	B6	1.6	1993.09 - 1997.10		410352.82D
1.8 i 16V	OK24N, OK26Y	1.8	1995.01 - 1997.10	82° Variante	410352.82D
1.8 i 16V	OK24N, OK26Y	1.8	1995.01 - 1997.10	88° Variante	410352.88D
<b>SHUMA (FB)</b>					
1.5	OK280	1.5	1996.03 - 1998.12		410352.88D
1.5 i 16V		1.5	1997.10 - 2001.10		410352.88D
1.6	GA6D	1.6	2001.05 - 2004.08		410352.88D
1.8	T8	1.8	2003.04 - 2004.08		410352.88D
1.8 i 16V	T8	1.8	1997.10 - 2001.03		410352.88D
<b>SPORTAGE (K00)</b>					
2.0		2.0	2000.10 - 2003.08		3498.88D
2.0 i	FE (8V)	2.0	1994.04 - 1999.08		3498.88D
2.0 i 16V	FE (16V)	2.0	1994.04 - 2003.08		3498.88D
2.0 TD	RF	2.0	1997.10 - 2003.08		3468.88D

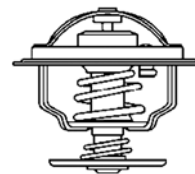

# LADA

	Engine	Ltr.	Year	Restriction*	Thermostat
<b>NIVA (2121)</b>					
1900 Diesel	XUD9A	1.9	1993.01 -		4446.83D
1900 Diesel	XUD9SD	1.9	1999.01 -		4446.83D
<b>NOVA</b>					
1500	BA3 21083	1.5	1989.06 -		3333.87
<b>SAMARA (2108, 2109)</b>					
1100	BA3 21081	1.1	1988.02 - 1994.12		3333.87
1100	BA3 21081 (KAT)	1.1	1996.02 -		3333.87
1300	BA3 2108	1.3	1986.01 - 1994.12		3333.87
1300	BA3 2108 (KAT)	1.3	1991.09 -		3333.87
1300	BA3 21115	1.3	1996.02 -		3333.87
1500	BA3 21083	1.5	1988.01 -		3333.87
1500	BA3 21083 (KAT)	1.5	1991.09 -		3333.87
1500	BA3 2111	1.5	1995.02 -		3333.87
<b>SAMARA FORMA</b>					
1100	BA3 21081 (KAT)	1.1	1991.07 -		3333.87
1300	BA3 2108	1.3	1989.05 - 1997.07		3333.87
1300	BA3 21115	1.3	1996.02 -		3333.87
1500	BA3 21083 (KAT)	1.5	1991.07 -		3333.87
1500	BA3 21083	1.5	1991.09 -		3333.87
1500	BA3 2111	1.5	1994.11 -		3333.87

# LANCIA

Engine

Ltr.

Year

Restriction\*

Thermostat

## DEDRA (835)

1.6 16V	182 A4.000	1.6	1996.01 - 1999.07		3163.88D
1.6 i.e.	835 A1.046, 835 C1.000	1.6	1989.08 - 1999.07		3109.82D
1.6 i.e.	835 A1.000	1.6	1989.08 - 1994.06		3109.87D
1.8 i.e.	836 A5.000	1.8	1994.07 - 1999.07		3159.82D
2.0 HF Integrale	835 A7.046	2.0	1990.11 - 1993.07	Motor no. →1517343	3159.82D
2.0 i.e.	835 A5.046	2.0	1989.09 - 1993.09		3159.82D
2.0 i.e.	835 A5.046	2.0	1993.09 - 1999.07		410956.83D
2.0 i.e. Turbo	835 A7.000, 835 A8.046	2.0	1991.04 - 1993.07	Motor no. →1518014	3159.82D
2.0 Turbo	835 A8.000	2.0	1990.11 - 1993.07	Motor no. →1517343	3159.82D

## DELTA I (831AB0)

1.6 GT i.e.	149 C2.000, 831 B7.000	1.6	1986.08 - 1988.08		4022.82D1
1.6 HF Turbo	831 B3.000, 831 B7.046	1.6	1986.08 - 1989.03		3159.82D
1.9 Turbo DS	831 D1.000	1.9	1986.10 - 1989.12		3431.80D
2.0 HF Integrale	831 B5.000, 831 C5.000, 831 C5.046	2.0	1986.11 - 1992.12		3159.82D

## DELTA II (836)

1.4 i.e.	836 A4.000, 160 A1.046	1.4	1994.10 - 1999.08		3109.87D
1.6 i.e.	835 C1.000	1.6	1993.06 - 1999.08		3109.87D
1.6 i.e.	182 A6.000	1.6	1996.03 - 1999.08	Motor no. 010785→	3163.88D
1.6 i.e. 16V	182 A4.000	1.6	1996.01 - 1999.08	Motor no. 010785→	3163.88D
1.8 i.e.	835 C2.000, 835 C4.000, 836 C4.000, 836 A6.000	1.8	1993.06 - 1999.08		3159.82D
1.9 TD	835 A4.000, 160 D1.000	1.9	1994.10 - 1999.08	Ölkühlung	410692.71D

## DELTA III (844)

1.4	198 A4.000	1.4	2008.09 -		410871.80D ▲
1.4 16V	198 A7.000	1.4	2010.07 -		410871.80D ▲
1.4 Bifuel	198 A4.000	1.4	2011.07 -		410871.80D ▲

## KAPPA (838)

2.0 20V	838 A1.000, 838 A6.000	2.0	1994.10 - 2001.10		410513.88D
2.4 20V	838 A2.000, 838 A2.027	2.4	1994.08 - 2001.10		410513.88D

## LYBRA (839)

1.6	182 B6.000	1.6	2000.10 - 2005.10		3163.88D
1.6 16V	182 A4.000	1.6	1999.07 - 2005.10		3163.88D
1.8 16V	839 A7.000, 839 A4.000	1.8	1999.07 - 2005.10		410514.88D
1.8 16V	839 A7.000, 839 A9.000, 839 A4.000	1.8	1999.07 - 2005.10		410514.88D
1.9 JTD	AR 32302	1.9	1999.07 - 2000.09		410512.88D
2.0 20V	182 B7.000	2.0	1999.07 - 2000.09		410513.88D
2.0 20V	185 A8.000	2.0	2000.09 - 2005.10		410994.88D
2.4 JTD	AR 32501, 839 A5.000	2.4	1999.07 - 2001.02		410512.88D

## MUSA

1.3 D Multijet	199 A3.000	1.2	2006.09 -		410048.88D
1.3 D Multijet	199 B1.000	1.2	2009.03 -		411774.88D ▲
1.4	843 A 1.000	1.4	2004.10 -		3151.87D
1.4	350 A1.000	1.4	2005.09 -		410090.88D
1.4 LPG	350 A1.000	1.4	2010.11 -		410090.88D

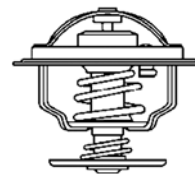

# LANCIA

	Engine	Ltr.	Year	Restriction*	Thermostat
<b>PHEDRA (179)</b>					
2.0	RFN (EW10J4)	2.0	2002.09 - 2010.11		3483.89D
2.0 JTD	RHK (DW10UTED4), RHM (DW10ATED4), RHW (DW10ATED4)	2.0	2002.09 - 2010.11		4446.83D
2.2 JTD	4HW(DW12ATED4)	2.2	2002.09 - 2010.11		4446.83D
<b>PRISMA (831AB0)</b>					
2.0 i.e.	831 B4.000	2.0	1986.04 - 1989.12		4022.82D1
<b>THEMA (834)</b>					
2000 i.e. (834B)	834 B.000	2.0	1984.11 - 1988.09		4022.82D1
2500 Turbo D (834D)	8144.91	2.5	1984.11 - 1988.09		4151.79D
2500 Turbo DS (834AE), (834D)	8144.97	2.5	1987.03 - 1988.09		4151.79D
2500 Turbo DS (834AE), (834D)	8144.97	2.5	1988.10 - 1992.05		3103.79
2500 Turbo DS (834AM)	8144. 97S	2.5	1988.05 - 1992.07		3103.79
2500 Turbo DS (834FE, 834LE)	8144.97 Y	2.5	1992.05 - 1994.07		3116.82D
2850 V6 i.e. (834AD, 834CD, 834BD)	834 E.146	2.85	1988.06 - 1992.05		4122.87D
2850 V6 i.e. (834F)	834 E.000	2.85	1984.11 - 1988.09		4122.87D
<b>THEESIS (841AX)</b>					
2.0 Turbo	841 E.000	2.0	2002.07 - 2009.07		410994.88D
2.4	841 D.000	2.4	2002.07 - 2009.07		410994.88D
2.4 JTD	841 C.000	2.4	2002.07 - 2009.07		410511.88D
2.4 JTD	841 G.000, 841 N.000, 841 M.000	2.4	2003.05 - 2009.07		411773.88D ▲
<b>Y (840A)</b>					
1.1	176 B2.000	1.1	1995.11 - 2003.09		3105.87D
1.2	840 A3.000, 188 A4.000	1.2	1996.03 - 2003.09		3105.87D
1.2 16V	176 B9.000	1.2	1997.04 - 2003.09		3105.87D
1.2 16V	188 A5.000	1.2	2000.10 - 2003.09		3151.87D
1.4 12V	840 A4.000	1.4	1996.03 - 2003.09		410515.88D
1.4 12V	840 A2.000	1.4	1996.10 - 2003.09		410515.88D
<b>Y10 (156)</b>					
1.0 Fire	156 A2.000, 156 A2.100, 156 A2.246	1.0	1985.03 - 1992.02		3105.87D
1.0 Fire	156 A.000	1.0	1985.03 - 1989.07		4091.82D
1.0 Turbo	156 A1.000	1.0	1985.03 - 1989.02		4091.82D
1.1 Avenue	176 B2.000	1.1	1995.01 - 1995.12		3105.87D
1.1 i.e	156 C.000	1.1	1989.08 - 1992.06		3105.87D
1.1 i.e. Fire	156 C.046	1.1	1989.07 - 1995.12		3105.87D
1.3 i.e. Fire	156 B.000, 146 A 5.046	1.3	1987.11 - 1995.12	Motor no. →3143798	3378.80
1.3 i.e. Fire	156 B.000, 146 A 5.046	1.3	1987.12 - 1995.12	Motor no. 3143798→	3373.80D
<b>YPSILON</b>					
1.2	188 A4.000	1.2	2003.10 - 2011.12		3105.87D
1.2	188 A5.000	1.2	2003.10 - 2011.12		3151.87D
1.3 D Multijet	199 A2.000, 199 A3.000	1.2	2006.09 - 2011.12		410048.88D
1.3 JTD	188 A9.000	1.25	2003.10 - 2011.12		410048.88D
1.4	350 A1.000	1.4	2006.02 - 2011.12		410090.88D
1.4 16V	843 A 1.000	1.4	2003.10 - 2011.12		3151.87D
1.4 LPG	350 A1.000	1.4	2010.11 - 2011.12		410090.88D

**LANCIA**

Engine

Ltr.

Year

Restriction\*

Thermostat

**ZETA (220)**

2.0 16V	RFV (XU10J4R)	2.0	1998.05 - 2000.07		<b>4450.83D</b>
2.0 16V	RFN	2.0	2000.07 - 2002.09		<b>3463.89D</b>
2.0 JTD	RHW (DW10ATED4), RHZ (DW10A-TED)	2.0	1999.09 - 2002.09		<b>4446.83D</b>
2.0 Turbo	RGX (XU10J2TE)	2.0	1995.05 - 2002.09		<b>3136.82D50</b>
2.1 TD	P 8 C	2.1	1996.05 - 1999.09		<b>4446.83D</b>

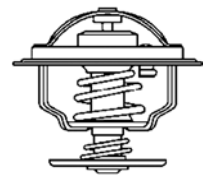

# LANDROVER

	Engine	Ltr.	Year	Restriction*	Thermostat
<b>88/109</b>					
2.3 4x4 (LR 88 OL, LR 109 OL)	11H	2.3	1963.09 - 1986.12		<b>3004.82</b>
2.3 4x4 (LR 88 OP, LR 109 OP)	11H	2.3	1963.09 - 1986.12		<b>3004.82</b>
2.3 D 4x4 (LR 88 DL, LR 109 DL)	23 J, 10 J	2.3	1963.09 - 1986.12		<b>3004.82</b>
2.3 D 4x4 (LR 88 DP, LR 109 DP)	23 J, 10 J	2.3	1963.09 - 1986.12		<b>3004.82</b>
<b>DEFENDER (LD)</b>					
2.5 90, 110 TDI	16 L, 23 L, 11 L	2.5	1990.09 - 1986.12		<b>3004.82</b>
<b>DISCOVERY I (LJ, LG)</b>					
2.5 TDI	19 L, 21 L, 17 L, 12 L	2.5	1989.10 - 1998.10		<b>3004.82</b>



# Thermostats

## LEXUS

	Engine	Ltr.	Year	Restriction*	Thermostat
<b>ES (F1, F2)</b>					
300	3VZ-FE	3.0	1991.09 - 1997.12		4480.82D
<b>ES (GSV4_, ACV4_)</b>					
3.5	GR-FE	3.5	2006.05 - 2012.06		4480.82D
<b>ES (MCV_, VZV_)</b>					
3.0	1MZ-FE	3.0	1996.10 - 2001.07		4480.82D
<b>GS (JZS147)</b>					
300	2JZ-GE	3.0	1993.03 - 1997.08		410231.82D
<b>GS (UZS161, JZS160)</b>					
300	2JZ-GE	3.0	2000.10 - 2005.03		410231.82D
300 T3	2JZ-GE	3.0	1997.08 - 2000.10		410231.82D
400	1UZ-FE	4.0	1997.12 - 2000.11		4480.82D
<b>IS I (JCE1_, GXE1_)</b>					
200	1G-FE	2.0	1999.04 - 2005.07		411545.82D ▲
300	2JZ-GE	3.0	2001.09 - 2005.07		410231.82D
<b>IS II (GSE2_, ALE2_, USE2_)</b>					
200d	2AD-FTV	2.2	2010.07 -		4480.82D
220d	2AD-FHV	2.2	2005.10 -		4480.82D
<b>IS SportCross</b>					
200	1G-FE	2.0	2002.10 - 2005.10		411545.82D ▲
300	2JZ-GE	3.0	2001.10 - 2005.10		410231.82D
<b>LS (UCF10)</b>					
400	1UZ-FE	4.0	1989.12 - 1994.12		4480.82D
<b>LS (UCF20)</b>					
400	1UZ-FE	4.0	1994.12 - 2000.10		4480.82D
<b>RX (MHU3_, GSU3_, MCU3_)</b>					
3.3	3MZ-FE	3.3	2003.04 - 2008.12		4480.82D
300	1MZ-FE	3.0	2003.05 - 2008.12		4480.82D
350	2GR-FE	3.5	2006.02 - 2008.12		4480.82D
400h	3MZ-FE	3.3	2004.09 - 2008.12		4480.82D
<b>RX (MCU15)</b>					
300	1MZ-FE	3.0	2000.07 - 2003.05		4480.82D
<b>RX (GYL1_, GGL15, AGL10)</b>					
270	1AR-FE	2.7	2008.12 -		4480.82D
350	2GR-FE	3.5	2008.12 -		4480.82D
350h	2GR-FXE	3.5	2012.04 -		4480.82D
450h	2GR-FXE	3.5	2008.12 -		4480.82D

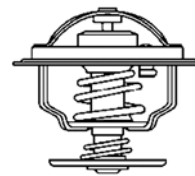

# LIGIER

	Engine	Ltr.	Year	Restriction*	Thermostat
<b>AMBRA</b>					
0.5		0.5	1996.12 -		<b>4007.80D</b>
<b>BE UP</b>					
0.5		0.5	2002.08 -		<b>4007.80D</b>
<b>NOVA</b>					
500		0.5	2002.08 -	Lombardini	<b>4007.80D</b>
650		0.5	2002.08 -	Lombardini	<b>4007.80D</b>

# Thermostats

## MAZDA

	Engine	Ltr.	Year	Restriction*	Thermostat
<b>2</b>					
1.25	FUJA	1.25	2003.04 -		4483.82D
1.3	ZJ-VE	1.3	2007.10 -		4639.82D
1.4	FXJA	1.4	2003.02 -		4483.82D
1.5	ZY-DE, ZY-VE	1.5	2003.04 -		4639.82D
1.6	FYJA	1.6	2003.02 -		4483.82D
<b>3</b>					
1.6	Z6	1.6	2004.02 -		4639.82D
2.0	LF17	2.0	2004.02 - 2006.06		4639.82D
2.3	L3-VE	2.3	2004.03 - 2009.03		4639.82D
1.4	FXJA, ZJ-VE	1.4	2003.10 - 2009.06		4639.82D
1.6	B6ZE	1.6	2003.10 - 2009.06		4639.82D
2.0	LF17	2.0	2003.10 - 2009.06		4639.82D
2.3	L3-VE	2.3	2004.03 - 2009.03		4639.82D
<b>5 (CR19)</b>					
2.0 CD	RF7J	2.0	2005.06 -		4639.82D
<b>6 (GG, GY)</b>					
2.0 DI	RF5C	2.0	2002.06 - 2007.08		4639.82D
<b>121 I (DA)</b>					
1.1	B1, B116	1.1	1987.10 - 1990.10		3119.82D3
1.3	B3	1.3	1987.10 - 1990.11		3119.82D3
<b>121 II (DB)</b>					
1.3 16V	B3 (16V)	1.3	1990.11 - 1996.03		3119.82D3
1.3 i 16V	B3 (16V)	1.3	1990.11 - 1996.03		3119.82D3
<b>121 III (JASM, JBSM)</b>					
1.25	DHG, DHF	1.25	1996.03 - 2003.04	Motor no. →001201	4457.82D
1.25	DHG, DHF	1.25	1996.04 - 2003.04	Motor no. 001201→	4483.82D
1.3	J4R, J4T, JJM, JJK	1.3	1996.03 - 2003.04		3004.92D1
1.8 D	RTJ, RTK	1.8	1996.03 - 2003.04		4270.88D
<b>323 I (FA)</b>					
1.0	P, PC	1.0	1977.06 - 1980.05		3119.82D3
1.3	T, TC	1.3	1977.01 - 1980.05		3119.82D3
1.4	U, UC	1.4	1978.05 - 1980.05		3119.82D3
1.5	D5	1.5	1982.04 - 1986.05		3119.82D3
<b>323 II (BD)</b>					
1.1	E1	1.1	1980.11 - 1985.10		3119.82D3
1.3	E3	1.3	1980.11 - 1989.10		3119.82D3
1.5	E5	1.5	1980.11 - 1986.09		3119.82D3
<b>323 III (BF, BW)</b>					
1.1	E1	1.1	1985.08 - 1990.04		3119.82D3
1.3	E3	1.3	1985.08 - 1990.04		3119.82D3
1.3 i	B3E	1.3	1985.09 - 1989.08		3119.82D3
1.4	B3	1.4	1987.04 - 1989.10		3119.82D3

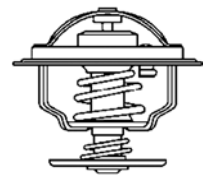

# MAZDA

	Engine	Ltr.	Year	Restriction*	Thermostat
1.5	B5, B50, B53, E5	1.5	1985.08 - 1989.10		3119.82D3
1.5 i	E5E3	1.5	1985.08 - 1989.05		3119.82D3
1.5 i Turbo	E5E2	1.5	1985.08 - 1989.05		3119.82D3
1.6	B6 (SOHC), B65M , B6E, B68	1.6	1986.09 - 1995.10		3119.82D3
1.6 GT	B6 (SOHC)	1.6	1985.08 - 1989.10		3119.82D3
1.6 GT Turbo	B6T	1.6	1985.10 - 1993.08		3119.82D3
<b>323 IV (BG)</b>					
1.3	B3E, B383	1.3	1989.09 - 1994.07		3499.82D
1.3 16V	B3 (16V)	1.3	1989.09 - 1994.07		3499.82D
1.6	B6E	1.6	1989.09 - 1991.06		3499.82D
1.6 16V	B6	1.6	1989.08 - 1994.10		3499.82D
1.8	BPC	1.8	1991.01 - 1994.04		3499.82D
1.8 16V	BP52	1.8	1989.08 - 1994.07		3499.82D
1.8 16V	BP	1.8	1989.08 - 1994.07		3499.82D
1.8 16V GT	BP (DOHC)	1.8	1989.06 - 1994.07		3499.82D
1.8 16V Turbo	BP Turbo	1.8	1990.09 - 1994.07		3498.88D
<b>323 V (BA)</b>					
1.3 16V	B3 (16V)	1.3	1994.08 - 1995.08		3499.82D
1.3 16V	B3 (16V)	1.3	1995.08 - 1998.09		3498.88D
1.5 16V	Z5-DE	1.5	1994.07 - 1995.08		3499.82D
1.5 16V	Z5-DE	1.5	1995.08 - 1998.09		3498.88D
1.8 16V	BP-ZE	1.8	1994.08 - 1998.09		3498.88D
2.0 24V	KF	2.0	1994.08 - 1998.09		4639.82D
2.0 D	RF1G	2.0	1996.10 - 1998.09		4639.82D
<b>323 VI (BJ)</b>					
1.4	B3 (16V)	1.4	2001.01 - 2004.05		3498.88D
1.4 16V	B3 ME	1.4	1998.09 - 2001.01		3498.88D
1.5 16V	ZL06, ZL05	1.5	1998.09 - 2001.01		3498.88D
1.6	ZM	1.6	2001.01 - 2004.05		3498.88D
1.9 16V	FP55	1.9	1998.09 - 2004.05		4639.82D
2.0	FS	2.0	2000.02 - 2004.05		4639.82D
2.0 D	RF1G	2.0	1998.09 - 2004.05		4639.82D
2.0 DiTD	RF4F	2.0	2000.10 - 2002.10		4639.82D
2.0 TD	RF3F, RF4F	2.0	1998.09 - 2004.05		4639.82D
<b>626 I (CB)</b>					
1.6	H6, NA, N	1.6	1979.05 - 1982.05		3119.88D3
2.0	HE3, MA, M	2.0	1979.05 - 1982.05		3119.88D3
<b>626 II (GC)</b>					
1.6	F6	1.6	1982.11 - 1987.09		3119.88D3
2.0	FE (8V)	2.0	1983.03 - 1987.09		3119.88D3
626 III (GD, GV)	1.6 F6	1.6	1987.06 - 1992.05		3119.88D3
1.8	F8 (12V)	1.8	1987.09 - 1992.05		3119.88D3
2.0	FE (8V)	2.0	1987.09 - 1987.09	OHC	3119.88D3
2.0	FE (12V)	2.0	1987.09 - 1990.10	OHC	3119.88D3
2.0 12V	FE (12V)	2.0	1987.09 - 1992.05	OHC	3119.88D3
2.0 16V	FE (16V)	2.0	1987.06 - 1992.05		3119.88D3
2.0 D	RFG5	2.0	1994.11 - 1997.09		3468.88D
2.0 D Complex	RF-CX	2.0	1993.05 - 1996.11		3468.88D
2.2 12V	F2L1, F2	2.2	1987.11 - 1996.11		3498.88D

# MAZDA

Engine

Ltr.

Year

Restriction\*

Thermostat

## 626 IV (GE)

1.8	FP	1.8	1991.08 - 1997.04		4639.82D
1.8 i	FP	1.8	1992.01 - 1997.04		4639.82D
2.0 D Comprex	RF OHC	2.0	1992.10 - 1997.04		3468.88D
2.0 i	FS	2.0	1991.08 - 1997.04		4639.82D
2.5 24V	KL	2.5	1992.01 - 1997.04		4639.82D

## 626 V (GF, GW)

1.8	FPY3	1.8	1997.05 - 1999.12		4639.82D
1.9	FP	1.9	1997.05 - 2000.01		4639.82D
2.0	FS	2.0	1997.05 - 2002.10		4639.82D
2.0 H.P.	FS2C	2.0	1998.02 - 2002.10		4639.82D
2.0 TD		2.0	2000.10 - 2002.10		4639.82D
2.0 Turbo DI	RF4F	2.0	1998.04 - 2002.10		4639.82D

## 929 II (HB, HV)

2.0	HEE, MA	2.0	1982.05 - 1987.12		3119.88D3
2.0	FE (8V)	2.0	1984.03 - 1987.07		3119.88D3
2.0 i	FE (8V)	2.0	1984.10 - 1987.07		3119.88D3
2.0 i Turbo	FET	2.0	1984.10 - 1987.07		3119.88D3

## 929 III (HC)

2.0	FEFA, FE (8V)	2.0	1987.06 - 1988.12		3119.88D3
2.2 12V	F21, F2E, F2	2.2	1988.01 - 1991.06		3119.88D3
2.2 i	F2-EGI	2.2	1987.05 - 1988.12		3119.88D3
3.0	JE	3.0	1987.06 - 1991.06		3119.88D3

## B-SERIE (UF, UN)

2.0	FE (8V)	2.0	1985.01 - 1991.12		3499.88D
2.2	F2L8	2.2	1991.08 - 1996.12		3499.88D
2.2 D	R290	2.2	1985.01 - 1996.03		3468.88D
2.5 D		2.5	1996.02 - 1999.06		4639.82D
2.5 D	MD25NA, WLE7	2.5	1999.06 -		4639.82D
2.5 TD	MD25TI	2.5	1999.06 - 2006.07		4639.82D

## BT-50 (CD, UN)

2.5	WLAA	2.5	2006.12 -		4639.82D
-----	------	-----	-----------	--	----------

## DEMIO (DW)

1.3 16V	B3 ME	1.3	1998.08 -		3499.88D
1.3 i 16V	B3 (16V)	1.3	1998.08 - 2000.04		3499.88D
1.5 16V	B5 E	1.5	2000.04 -		3499.88D

## E 1600, 2000

2200 D	R203, R207	2.2	1991.03 - 2003.05		3468.88D
E2000	FE18, FEV4	2.0	1984.11 - 2003.05		3499.88D
E2200 D	R2	2.2	1984.01 - 2003.05		3468.88D

## MPV I (LV)

2.5 TD	WL-T	2.5	1996.05 - 1999.09		4639.82D
3.0 i V6	JE94	3.0	1995.03 - 1999.09		4639.82D

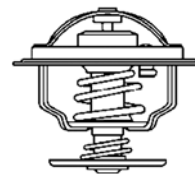

# MAZDA

	Engine	Ltr.	Year	Restriction*	Thermostat
<b>MPV II (LW)</b>					
2.0	FS-DS	2.0	1999.09 - 2002.07		4639.82D
2.0 DI	RF5C	2.0	2002.07 - 2006.02		4639.82D
<b>MX-3 (EC)</b>					
1.6 i	B69, B6D	1.6	1991.07 -		3498.88D
1.8 i V6	K819, K838	1.8	1992.01 -		4639.82D
<b>MX-5 I (NA)</b>					
1.6	B64F	1.6	1990.05 -		3498.88D
1.8	BPF1, BP (DOHC)	1.8	1993.09 - 1998.04		3498.88D
<b>MX-5 II (NB)</b>					
1.6 16V	B6D	1.6	1998.05 - 2005.10		3498.88D
1.8	BPD	1.8	1998.01 - 2002.07		3498.88D
1.8 16V	BP-ZE, BPD	1.8	1998.05 - 2005.10		3498.88D
<b>MX-6 (GE)</b>					
2.0	FS	2.0	1992.02 - 1997.02		4639.82D
2.5 i 24V	KL	2.5	1994.08 - 1997.02		4639.82D
<b>PREMACY (CP)</b>					
1.9	FP	1.9	1999.07 - 2005.03		4639.82D
2.0	FS7G, FS7E, LFF7	2.0	2001.11 - 2005.03		4639.82D
2.0 TD	RF3F, RF4F	2.0	1999.10 - 2005.03		4639.82D
2.3 SVT		2.3	2005.02 - 2005.03		4639.82D
<b>TRIBUTE (EP)</b>					
2.0	YF	2.0	2000.03 - 2008.05		4270.88D
<b>XEDOS 6</b>					
1.6 16V	B6 (DOHC)	1.6	1994.06 - 1999.10		3498.88D
2.0 24V	KF	2.0	1993.08 - 2000.01		4639.82D
2.0 V6	KF1	2.0	1992.01 - 1999.10		4639.82D
2.3 24V	KJ -ZEM	2.3	1995.02 - 2000.01		4639.82D
2.5 24V	KL	2.5	1993.07 - 2000.07		4639.82D
2.5 V6	KL	2.5	2000.07 - 2002.09		4639.82D

# Thermostats

## MERCEDES-BENZ

	Engine	Ltr.	Year	Restriction*	Thermostat
<b>114 Serie /8 (W114)</b>					
230.6	M 180.954	2.3	1968.01 - 1976.11		<b>4078.79D</b>
250	M 114.920	2.5	1968.01 - 1972.08		<b>4078.79D</b>
250 2.8	M 130.923	2.8	1972.06 - 1976.11		<b>4078.79D</b>
250 C	M 114.920	2.5	1969.04 - 1972.06		<b>4078.79D</b>
250 C 2.8	M 130.923	2.8	1972.06 - 1976.11		<b>4078.79D</b>
250 CE	M 114.980	2.5	1969.04 - 1972.04		<b>4078.79D</b>
280	M 110.921	2.7	1972.06 - 1976.11		<b>4078.79D</b>
280 C	M 110.921	2.7	1972.06 - 1977.02		<b>4078.79D</b>
280 CE	M 110.981	2.7	1972.06 - 1977.01		<b>4078.79D</b>
280 E	M 110.981	2.7	1972.06 - 1976.11		<b>4078.79D</b>
<b>115 Serie /8 (W115)</b>					
200	M 115.923, M 115.926	2.0	1968.01 - 1977.01		<b>4078.79D</b>
200 D	OM 615.913	2.0	1968.01 - 1977.01		<b>4049.80D1</b>
220	M 115.920, M 115.924	2.2	1968.01 - 1973.07		<b>4078.79D</b>
220 D	OM 615.912	2.2	1968.01 - 1977.01		<b>4049.80D1</b>
230.4	M 115.951	2.3	1973.08 - 1976.12		<b>4078.79D</b>
240 D	OM 616.916	2.4	1973.08 - 1977.01		<b>4117.80D</b>
240 D 3.0	OM 617.910	3.0	1974.08 - 1976.11		<b>4049.80D1</b>
<b>123 Serie</b>					
200	M 115.938 / M 115.939/M 102.920 / M 102.939	2.0	1976.02 - 1985.11		<b>4078.87D</b>
200 D	OM 615.940	2.0	1976.07 - 1985.11	Motor no. →142197 Schaltgetriebe	<b>4117.80D</b>
200 D	OM 615.940	2.0	1976.07 - 1985.11	Motor no. →004748 Automatikgetriebe	<b>4117.80D</b>
200 D	OM 615.940	2.0	1976.10 - 1985.11	Motor no. 142198→ Schaltgetriebe	<b>4049.80D1</b>
200 D	OM 615.940	2.0	1976.10 - 1985.11	Motor no. 004749→ Automatikgetriebe	<b>4049.80D1</b>
220 D	OM 615.941	2.0	1976.07 - 1985.11	Motor no. →004748 Automatikgetriebe	<b>4117.80D</b>
220 D	OM 615.941	2.0	1976.07 - 1985.11	Motor no. →142197 Schaltgetriebe	<b>4117.80D</b>
220 D	OM 615.941	2.0	1976.10 - 1985.11	Motor no. 004749→ Automatikgetriebe	<b>4049.80D1</b>
220 D	OM 615.941	2.0	1976.10 - 1985.11	Motor no. 142198→ Schaltgetriebe	<b>4049.80D1</b>
230	M 102.980 / M 115.954	2.3	1976.02 - 1985.12		<b>4078.87D</b>
240 D	OM 616.912	2.0	1976.02 - 1985.11	Motor no. →027798 Automatikgetriebe	<b>4117.80D</b>
240 D	OM 616.912	2.0	1976.02 - 1985.11	Motor no. →086378 Schaltgetriebe	<b>4117.80D</b>
240 D	OM 616.912	2.0	1976.10 - 1985.11	Motor no. 086379→ Schaltgetriebe	<b>4049.80D1</b>
240 D	OM 616.912	2.0	1976.10 - 1985.11	Motor no. 027799→ Automatikgetriebe	<b>4049.80D1</b>
250	M 123.921	2.5	1976.02 - 1985.07		<b>4078.87D</b>
280 E	M 110.923, M 110.984/M110.988	2.7	1976.02 - 1985.11		<b>4078.87D</b>
300 C Turbo-D	OM 617.952	3.0	1981.09 - 1985.07		<b>4049.80D1</b>
300 D	OM 617.912	2.0	1976.02 - 1985.11	Motor no. →067785 Automatikgetriebe	<b>4117.80D</b>
300 D	OM 617.912	2.0	1976.02 - 1985.11	Motor no. →073575 Schaltgetriebe	<b>4117.80D</b>
300 D	OM 617.912	2.0	1976.10 - 1985.11	Motor no. 067786→ Automatikgetriebe	<b>4049.80D1</b>

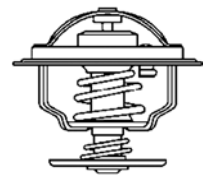

# MERCEDES-BENZ

	Engine	Ltr.	Year	Restriction*	Thermostat
300 D	OM 617.912	2.0	1976.10 - 1985.11	Motor no. 073576 → Schaltgetriebe	<b>4049.80D1</b>
300 T Turbo-D	OM 617.952	3.0	1980.10 - 1985.11		<b>4049.80D1</b>
300 Turbo-D	OM 617.952	3.0	1981.08 - 1985.07		<b>4049.80D1</b>
<b>124 Serie</b>					
200	M 102.922	2.0	1985.12 - 1990.05		<b>4078.87D</b>
200 D	OM 601.912	2.0	1984.12 - 1993.06		<b>4176.85D</b>
200 E	M 102.922/M 102.962/M 102.963	2.0	1988.09 - 1993.05		<b>4078.87D</b>
200 E	M 111.940	2.0	1992.10 - 1993.06		<b>4275.87D</b>
220 E	M 111.960	2.2	1992.10 - 1993.06		<b>4275.87D</b>
230 E	M 102.982	2.3	1984.12 - 1993.06		<b>4078.87D</b>
250 D	OM 602.912	2.5	1985.04 - 1993.06		<b>4176.85D</b>
250 TD Turbo	OM 602.962	2.5	1988.03 - 1993.07		<b>4176.80D</b>
250 Turbo-D	OM 602.962	2.5	1988.09 - 1993.06		<b>4176.80D</b>
260 E	M 103.940	2.6	1985.09 - 1992.08		<b>4078.87D</b>
280 E	M 104.942	2.8	1992.10 - 1993.06		<b>4078.87D</b>
300 CE	M 103.983	3.0	1987.03 - 1993.05		<b>4078.87D</b>
300 CE-24	M 104.980	3.0	1989.09 - 1993.06		<b>4078.87D</b>
300 D	OM 603.912/OM 603.913	3.0	1984.12 - 1993.06		<b>4176.85D</b>
300 E	M 103.980/M 103.983/M 103.985	3.0	1985.01 - 1993.06		<b>4078.87D</b>
300 E-24	M 104.980	3.0	1988.09 - 1992.08		<b>4078.87D</b>
300 T D	OM 603.912	3.0	1986.09 - 1993.06		<b>4176.85D</b>
300 TD T	OM 603.960	3.0	1992.06 - 1993.05		<b>4176.85D</b>
300 TE	M 103.983/M 103.985	3.0	1986.01 - 1993.06		<b>4078.87D</b>
300 TE	M 104.980	3.0	1989.09 - 1992.08		<b>4078.87D</b>
300 Turbo-D	OM 603.960, OM 603.963	3.0	1986.09 - 1993.06		<b>4176.80D</b>
320 E	M 104.992	3.2	1992.10 - 1993.06		<b>4078.87D</b>
400 E 4.2	M 119.975	4.2	1992.10 - 1993.06	Motor no. →020770	<b>4137.80D</b>
400 E 4.2	M 119.975	4.2	1992.11 - 1993.06	Motor no. 020771 →	<b>4278.80D</b>
500 E	M 119.974	5.0	1991.01 - 1993.06	Motor no. →010204	<b>4137.80D</b>
500 E	M 119.974	5.0	1991.02 - 1993.06	Motor no. 010205 →	<b>4278.80D</b>
<b>190 (201)</b>					
2.0	M 102.921/M 102.924	2.0	1982.10 - 1990.05		<b>4078.87D</b>
2.3	M 102.985	2.3	1987.09 - 1988.09		<b>4078.87D</b>
2.3 E	M 102.985	2.3	1982.10 - 1988.09		<b>4078.87D</b>
2.6	M 103.942	2.6	1982.10 - 1988.09		<b>4078.87D</b>
D 2.0	OM 601.911	2.0	1983.08 - 1993.08		<b>4176.85D</b>
D 2.5	OM 602.911	2.5	1985.04 - 1993.08		<b>4176.85D</b>
E 1.8	M 102.910	1.8	1990.04 - 1993.08		<b>4078.87D</b>
E 2.0	M 102.961	2.0	1982.10 - 1993.06		<b>4078.87D</b>
E 2.0	M 102.961, M 102.962	2.0	1982.10 - 1993.08		<b>4078.87D</b>
E 2.3	M 102.985	2.3	1986.09 - 1993.08		<b>4078.87D</b>
E 2.3-16	M 102.983	2.3	1984.04 - 1988.08		<b>4078.87D</b>
E 2.5-16	M 102.990/M 102.991	2.5	1988.09 - 1993.08		<b>4078.87D</b>
E 2.6	M 103.942	2.6	1986.09 - 1993.08		<b>4078.87D</b>
E Evolution II 2.5	M 102.992	2.5	1990.05 - 1993.08		<b>4078.87D</b>
Turbo-D 2.5	OM 602.961	2.5	1988.02 - 1993.08		<b>4176.80D</b>
<b>A-Klasse (W168)</b>					
A 140	M 166.940/M 166.960	1.4	1997.07 - 2004.08		<b>411576.87D ▲</b>
A 160	M 166.960	1.6	1997.07 - 2004.08		<b>411576.87D ▲</b>
A 190	M 166.990	1.9	1999.03 - 2004.08		<b>411576.87D ▲</b>
A 210	M 166.995	2.1	2002.03 - 2004.08		<b>411576.87D ▲</b>



**MERCEDES-BENZ**

Engine

Ltr.

Year

Restriction\*

Thermostat

**A-Klasse (W169)**

A 150	M 266.920	1.5	2004.09 - 2012.06		411577.80D ▲
A 160	M 266.920	1.5	2009.04 - 2012.06		411577.80D ▲
A 170	M 266.940	1.7	2004.09 - 2012.06		411577.80D ▲
A 180	M 266.940	1.7	2009.04 - 2012.06		411577.80D ▲
A 200	M 266.960	2.0	2004.09 - 2012.06		411577.80D ▲

**B-Klasse (W245)**

B 150	M 266.920	1.5	2005.03 - 2011.11		411577.80D ▲
B 160	M 266.920	1.5	2009.04 - 2011.11		411577.80D ▲
B 170	M 266.940	1.7	2005.03 - 2011.11		411577.80D ▲
B 170 NGT	M 266.960	2.0	2008.04 - 2011.11		411577.80D ▲
B 180	M 266.940	1.7	2009.04 - 2011.11		411577.80D ▲
B 180 NGT	M 266.960	2.0	2008.04 - 2011.11		411577.80D ▲
B 200	M 266.960	2.0	2005.03 - 2011.11		411577.80D ▲

**C-Klasse (202)**

C 180	M 111.921, M 111.920/M 111.952	1.8	1993.03 - 2001.03	mit Klimaanlage	4275.87D
C 180	M 111.921, M 111.920/M 111.952	1.8	1993.03 - 2001.03	ohne Klimaanlage	4276.87D
C 200	M 111.941, M 111.945	2.0	1994.01 - 2001.03	mit Klimaanlage	4275.87D
C 200	M 111.941, M 111.945	2.0	1994.01 - 2001.03	ohne Klimaanlage	4276.87D
C 200 D	OM 601.913	2.0	1993.03 - 2000.05		4176.85D
C 200 D	OM 604.915	2.0	1996.10 - 2001.03	ohne Gehäuse	4176.85D
C 200 D	OM 604.915	2.0	1996.10 - 2001.03	mit Gehäuse	4280.85D
C 200 Kompressor	M 111.944/M 111.956	2.0	1995.10 - 2001.03		4275.87D
C 220	M 111.961	2.2	1993.03 - 2000.05	mit Klimaanlage	4275.87D
C 220	M 111.961	2.2	1993.03 - 2000.05	ohne Klimaanlage	4276.87D
C 220 D	OM 604.910	2.2	1993.08 - 2000.05	ohne Gehäuse	4176.85D
C 220 D	OM 604.910	2.2	1993.08 - 2000.05	mit Gehäuse	4280.85D
C 230	M 111.974	2.3	1996.06 - 1998.06	mit Klimaanlage	4275.87D
C 230	M 111.974	2.3	1996.06 - 1998.06	ohne Klimaanlage	4276.87D
C 230 Kompressor	M 111.975	2.3	1995.10 - 2000.09		4275.87D
C 240	M 112.910/M 112.915	2.4	1997.06 - 2001.03		4281.87D
C 250 D	OM 605.910	2.5	1993.05 - 2000.05		4176.85D
C 250 Turbo-D	OM 605.960	2.5	1995.10 - 2001.03	ohne Gehäuse	4176.80D
C 250 Turbo-D	OM 605.960	2.5	1995.10 - 2001.03	mit Gehäuse	4280.80D
C 280	M 104.941	2.8	1993.05 - 2000.05		4078.87D
C 280	M 112.920	2.8	1997.06 - 2001.03		4281.87D
C 36 AMG	M 104.941 (AMG 3.6)	3.6	1994.05 - 2000.05		4078.87D
C 43 AMG	M 113.944	4.3	1997.08 - 2001.03		4281.87D

**C-Klasse (203)**

C 160	M 271.911	1.6	2009.02 - 2011.06		3457.90D
C 160 Kompressor	M 271.921	1.8	2002.05 - 2008.05		3457.90D
C 180	M 111.951	2.0	2000.10 - 2002.05	Motor no. 32199684→	4414.87D
C 180 Kompressor	M 271.946	1.8	2002.05 - 2011.06		3457.90D
C 200 CDI	OM 646.962	2.1	2001.02 - 2008.05	ohne Gewinde	410174.92D
C 200 CDI	OM 646.962	2.1	2001.02 - 2008.05	mit Gewinde	411434.92D ▲
C 200 CGI Kompressor	M 271.942	1.8	2003.03 - 2008.05		3457.90D
C 200 Kompressor	M 111.955	2.0	2000.05 - 2002.05	Motor no. 32199737→	4414.87D
C 200 Kompressor	M 271.940/M 271.955	1.8	2002.05 - 2011.06		3457.90D
C 220 CDI	OM 646.963	2.1	2004.02 - 2011.06	ohne Gewinde	410174.92D
C 220 CDI	OM 646.963	2.1	2004.02 - 2011.06	mit Gewinde	411434.92D ▲

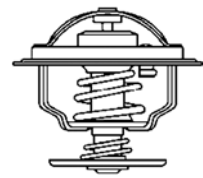

## MERCEDES-BENZ

	Engine	Ltr.	Year	Restriction*	Thermostat
C 230	M 272.920	2.5	2005.03 - 2011.06	Motor no. 30058377→	4834.100D
C 230 Kompressor	M 111.981	2.3	2001.03 - 2002.05	Motor no. 32200308→	4414.87D
C 230 Kompressor	M 271.948	1.8	2002.05 - 2008.05		3457.90D
C 240	M 112.912/M 112.916	2.6	2000.05 - 2007.08		4281.87D
C 280	M 272.940/M 272.941	3.0	2005.01 - 2007.08	Motor no. 30058377→	4834.100D
C 32 AMG Kompressor	M 112.961	3.2	2001.02 - 2008.05		4298.87D
C 320	M 112.946/M 112.953	3.2	2000.05 - 2008.05		4281.87D
C 320 CDI	OM 642.910	3.0	2005.01 - 2007.08	Europa Ausführung	4490.87D
C 350	M 272.960, M 272.970	3.5	2005.03 - 2011.06	Motor no. 30058377→	4834.100D
C 55 AMG	M 113.988	5.4	2004.02 - 2007.08		4281.87D
<b>C-Klasse (204)</b>					
C 180	M 271.820	1.8	2011.06 -		410389.103D ▲
C 180 CGI	M 271.820	1.8	2007.01 -		410389.103D ▲
C 180 Kompressor	M 271.910/M 271.952	1.6	2007.01 -		3457.90D
C 200	M 271.820	1.8	2011.05 -		410389.103D ▲
C 200 CDI	OM 646.811, OM 646.812	2.1	2007.01 -	ohne Gewinde	410174.92D
C 200 CDI	OM 646.811, OM 646.812	2.1	2007.01 -	mit Gewinde	411434.92D ▲
C 200 CGI	M 271.820, M 271.860	1.8	2007.01 -		410389.103D ▲
C 200 Kompressor	M 271.950	1.8	2007.01 -		3457.90D
C 220 CDI	OM 646.811	2.1	2007.01 -	ohne Gewinde	410174.92D
C 220 CDI	OM 646.811	2.1	2007.01 -	mit Gewinde	411434.92D ▲
C 230	M 272.911/M 272.921	2.5	2007.01 -		4834.100D
C 250	M 271.860	1.8	2011.06 -		410389.103D ▲
C 250 CGI	M 271.860	1.8	2009.07 -		410389.103D ▲
C 280	M 272.947/M 272.948	3.0	2007.01 -		4834.100D
C 300	M 272.947/M 272.948	3.0	2007.07 -		4834.100D
C 320 CDI	OM 642.960/OM 642.961	3.0	2007.01 -	elektrisch	4835.87D
C 320 CDI	OM 642.961	3.0	2007.07 -	thermisch	4490.87D
C 350	M 272.961/M 272.971	3.5	2007.01 -		4834.100D
C 350 CDI	OM 642.960/OM 642.961	3.0	2009.07 -	thermisch	4490.87D
C 350 CDI	OM 642.960/OM 642.961	3.0	2009.07 -	elektrisch	4835.87D
C 350 CGI	M 272.982	3.5	2008.09 -		4834.100D
<b>CLK (208)</b>					
200	M 111.941, M 111.945	2.0	1997.06 - 2002.06	mit Klimaanlage	4275.87D
200	M 111.941, M 111.945	2.0	1997.06 - 2002.06	ohne Klimaanlage	4276.87D
200 Kompressor	M 111.944/M 111.956	2.0	1997.06 - 2002.06		4275.87D
230 Kompressor	M 111.975, M 111.973/M 111.982	2.3	1997.06 - 2002.06		4275.87D
320	M 112.940	3.2	1997.06 - 2002.06		4281.87D
430	M 113.943	4.3	1998.07 - 2002.06		4281.87D
55 AMG	M 113.981, M 113.984	5.4	1999.08 - 2002.06		4281.87D
<b>CLK (209)</b>					
200 CGI	M 271.942	1.8	2003.07 - 2009.05		3457.90D
200 Kompressor	M 271.940/M 271.955	1.8	2002.09 - 2009.05		3457.90D
220 CDI	OM 646.966	2.1	2005.01 - 2009.05	ohne Gewinde	410174.92D
220 CDI	OM 646.966	2.1	2005.01 - 2009.05	mit Gewinde	411434.92D ▲
240	M 112.912	2.6	2002.06 - 2009.05		4281.87D
280	M 272.940	3.0	2005.03 - 2009.05	Motor no. 30058377→	4834.100D
320	M 112.955	3.2	2002.06 - 2009.05		4281.87D
320 CDI	OM 642.910	3.0	2005.01 - 2009.05	thermisch	4490.87D

# Thermostats

## MERCEDES-BENZ

	Engine	Ltr.	Year	Restriction*	Thermostat
320 CDI	OM 642.910	3.0	2005.01 - 2009.05	elektrisch	4835.87D
350	M 272.960	3.5	2005.03 - 2009.05	Motor no. 30058377→	4834.100D
500	M 113.968	5.0	2002.06 - 2009.05		4281.87D
500	M 273.965	5.5	2006.06 - 2009.05		4833.100D
55 AMG	M 113.987	5.4	2002.09 - 2009.05		4281.87D
CLK 200 CGI	M 271.942	1.8	2003.07 - 2010.03		3457.90D
CLK 200 Kompressor	M 271.940/M 271.955	1.8	2003.02 - 2010.03		3457.90D
CLK 240	M 112.912	2.6	2003.02 - 2010.03		4281.87D
CLK 280	M 272.940	3.0	2005.03 - 2010.03	Motor no. 30058377→	4834.100D
CLK 320	M 112.955	3.2	2003.02 - 2010.03		4281.87D
CLK 320 CDI	OM 642.910	3.0	2005.03 - 2010.03	thermisch	4490.87D
CLK 320 CDI	OM 642.910	3.0	2005.03 - 2010.03	elektrisch	4835.87D
CLK 350	M 272.960	3.5	2005.03 - 2010.03	Motor no. 30058377→	4834.100D
CLK 500	M 113.968	5.0	2003.02 - 2010.03		4281.87D
CLK 500	M 273.967	5.5	2006.06 - 2010.03		4829.100D ▲
CLK 55 AMG	M 113.987	5.4	2003.02 - 2010.03		4281.87D
<b>CLS (C219)</b>					
CLS 280	M 272.943	3.0	2008.07 - 2010.12		4834.100D
CLS 300	M 272.943	3.0	2009.04 - 2010.12		4834.100D
CLS 320 CDI	OM 642.920	3.0	2005.01 - 2010.12	thermisch	4490.87D
CLS 320 CDI	OM 642.920	3.0	2005.01 - 2010.12	elektrisch	4835.87D
CLS 350	M 272.964	3.5	2005.03 - 2010.12	Motor no. 30000484→	4834.100D
CLS 350	M 272.985	3.5	2006.04 - 2010.12		4834.100D
CLS 350 CDI	OM 642.920	3.0	2009.04 - 2010.12	thermisch	4490.87D
CLS 350 CDI	OM 642.920	3.0	2009.04 - 2010.12	elektrisch	4835.87D
CLS 350 CGI	M 272.985	3.5	2009.04 - 2010.12		4834.100D
CLS 500	M 113.967	5.0	2004.10 - 2010.12		4281.87D
CLS 500	M 273.960	5.5	2006.04 - 2010.12		4829.100D ▲
<b>E-Klasse (124)</b>					
E 200	M 111.940	2.0	1993.06 - 1998.03		4275.87D
E 200 D	OM 601.912	2.0	1993.06 - 1995.06		4176.80D
E 220	M 111.960	2.2	1993.06 - 1998.03		4275.87D
E 250 D	OM 605.911	2.5	1993.06 - 1996.06		4176.85D
E 250 Turbo D	OM 602.962	2.5	1993.06 - 1996.06		4176.80D
E 280	M 104.942	2.8	1993.06 - 1996.06		4078.87D
E 300	M 103.985	3.0	1993.06 - 1996.06		4078.87D
E 300 D	OM 606.910	3.0	1993.06 - 1996.06		4176.80D
E 300 TE-24	M 104.980	3.0	1993.06 - 1996.06		4078.87D
E 300 Turbo-D	OM 603.963	3.0	1993.06 - 1995.06		4176.80D
E 300 Turbo-D	OM 603.960	3.0	1993.06 - 1995.06		4176.85D
E 320	M 104.992, M 104.995	3.2	1993.06 - 1998.03		4078.87D
E 36 AMG	M 104.992 (AMG 3.6)	3.6	1993.06 - 1998.03		4078.87D
E 420	M 119.975	4.2	1993.06 - 1995.06	Motor no. 020771→	4278.80D
E 420	M 119.975	4.2	1993.07 - 1995.06	Motor no. →020770	4137.80D
E 500	M 119.974	5.0	1993.06 - 1995.06	Motor no. 010205→	4278.80D
E 500	M 119.974	5.0	1993.07 - 1995.06	Motor no. →010204	4137.80D
<b>E-KLASSE (207)</b>					
E 200 CGI	M 271.820, M 271.860	1.8	2010.01 -		410389.103D ▲
E 250 CGI	M 271.860	1.8	2009.01 -		410389.103D ▲

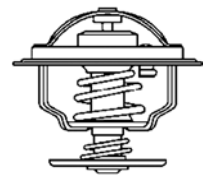
**MERCEDES-BENZ**

	Engine	Ltr.	Year	Restriction*	Thermostat
E 350 CGI	M 272.982, M 272.984	3.5	2009.01 -		<b>4834.100D</b>
E 500	M 273.966	5.5	2009.01 -		<b>4833.100D</b>
<b>E-Klasse (210)</b>					
E 200	M 111.942	2.0	1995.06 - 2000.08		<b>4276.87D</b>
E 200 D	OM 604.917	2.0	1996.01 - 2002.03	ohne Gehäuse	<b>4176.85D</b>
E 200 D	OM 604.917	2.0	1996.01 - 2002.03	mit Gehäuse	<b>4280.85D</b>
E 200 Kompressor	M 111.947/M 111.957	2.0	1997.06 - 2003.03		<b>4275.87D</b>
E 220 D	OM 604.912	2.2	1995.06 - 2002.03	ohne Gehäuse	<b>4176.85D</b>
E 220 D	OM 604.912	2.2	1995.06 - 2002.03	mit Gehäuse	<b>4280.85D</b>
E 230	M 111.970	2.3	1995.06 - 1997.06		<b>4276.87D</b>
E 240	M 112.911/M 112.914	2.4	1997.06 - 2003.03		<b>4281.87D</b>
E 250 D	OM 605.912	2.5	1995.06 - 1999.07		<b>4176.85D</b>
E 250 Turbo-D	OM 605.962	2.5	1997.06 - 1999.07	ohne Gehäuse	<b>4176.80D</b>
E 250 Turbo-D	OM 605.962	2.5	1997.06 - 1999.07	mit Gehäuse	<b>4280.80D</b>
E 280	M 104.945	2.8	1996.01 - 1997.06		<b>4078.87D</b>
E 280	M 112.921	2.8	1996.12 - 2003.03		<b>4281.87D</b>
E 290 Turbo-D	OM 602.982	2.9	1996.03 - 1999.07	ohne Gehäuse	<b>4176.85D</b>
E 290 Turbo-D	OM 602.982	2.9	1996.03 - 1999.07	mit Gehäuse	<b>4280.85D</b>
E 300 D	OM 606.912	3.0	1995.06 - 1997.06		<b>4176.85D</b>
E 300 Turbo-D	OM 606.962	3.0	1996.12 - 1999.07	ohne Gehäuse	<b>4176.80D</b>
E 300 Turbo-D	OM 606.962	3.0	1996.12 - 1999.07	mit Gehäuse	<b>4280.80D</b>
E 320	M 104.995	3.2	1995.06 - 1997.06		<b>4078.87D</b>
E 320	M 112.941	3.2	1997.06 - 2003.03		<b>4281.87D</b>
E 420	M 119.985	4.2	1996.01 - 1997.06		<b>4278.80D</b>
E 430	M 113.940	4.3	1997.06 - 2003.03		<b>4281.87D</b>
E 50 AMG	M 119.985 (AMG 5.0)	5.0	1996.02 - 1997.08		<b>4278.80D</b>
E 55 AMG	M 113.980	5.4	1997.08 - 2003.03		<b>4281.87D</b>
<b>E-Klasse (211)</b>					
3.5 4-matic	M 272.972	3.5	2004.08 - 2006.08		<b>4834.100D</b>
350 CGI	M 272.985	3.5	2006.05 - 2009.07		<b>4834.100D</b>
E 200 CDI	OM 646.951	2.1	2002.07 - 2008.12	ohne Gewinde	<b>410174.92D</b>
E 200 CDI	OM 646.951	2.1	2002.07 - 2008.12	mit Gewinde	<b>411434.92D ▲</b>
E 200 CDI	OM 646.820	2.1	2006.04 - 2008.12	ohne Gewinde	<b>410174.92D</b>
E 200 CDI	OM 646.821	2.1	2006.04 - 2009.07	ohne Gewinde	<b>410174.92D</b>
E 200 CDI	OM 646.820	2.1	2006.04 - 2008.12	mit Gewinde	<b>411434.92D ▲</b>
E 200 CDI	OM 646.821	2.1	2006.04 - 2009.07	mit Gewinde	<b>411434.92D ▲</b>
E 200 CGI	M 271.946	1.8	2002.11 - 2008.12		<b>3457.90D</b>
E 200 Kompressor	M 271.941/M 271.956	1.8	2002.11 - 2009.07		<b>3457.90D</b>
E 200 NGT	M 271.941	1.8	2004.03 - 2009.07		<b>3457.90D</b>
E 220 CDI	OM 646.821/OM 646.961	2.1	2002.03 - 2009.07	ohne Gewinde	<b>410174.92D</b>
E 220 CDI	OM 646.821/OM 646.961	2.1	2002.03 - 2009.07	mit Gewinde	<b>411434.92D ▲</b>
E 230	M 272.922	2.5	2007.05 - 2009.07		<b>4834.100D</b>
E 240	M 112.913, M 112.917	2.6	2002.03 - 2009.07		<b>4281.87D</b>
E 270 CDI	OM 647.961	2.7	2002.03 - 2009.07	ohne Gewinde	<b>410174.92D</b>
E 270 CDI	OM 647.961	2.7	2002.03 - 2009.07	mit Gewinde	<b>411434.92D ▲</b>
E 280	M 272.943	3.0	2005.03 - 2009.07		<b>4834.100D</b>
E 280 CDI	OM 648.961	3.2	2004.05 - 2008.12	ohne Gewinde	<b>410174.92D</b>
E 280 CDI	OM 648.961	3.2	2004.05 - 2008.12	mit Gewinde	<b>411434.92D ▲</b>
E 280 CDI	OM 642.920	3.0	2005.03 - 2009.07	thermisch, Europa Ausführung	<b>4490.87D</b>
E 280 CDI	OM 642.920	3.0	2005.03 - 2009.07	elektrisch, Japan, USA	<b>4835.87D</b>
E 280 T CDI	OM 648.961	3.2	2004.05 - 2009.07	ohne Gewinde	<b>410174.92D</b>
E 280 T CDI	OM 648.961	3.2	2004.05 - 2009.07	mit Gewinde	<b>411434.92D ▲</b>
E 300 BLUETEC	OM 642.920	3.0	2007.09 - 2008.12	thermisch	<b>4490.87D</b>

## MERCEDES-BENZ

Engine

Ltr.

Year

Restriction\*

Thermostat

E 300 BLUETEC	OM 642.920	3.0	2007.09 - 2008.12	elektrisch	4835.87D
E 320	M 112.949, M 112.954	3.2	2002.03 - 2009.07		4281.87D
E 320 CDI	OM 648.961	3.2	2003.03 - 2009.07	ohne Gewinde	410174.92D
E 320 CDI	OM 648.961	3.2	2003.03 - 2009.07	mit Gewinde	411434.92D ▲
E 320 CDI	OM 642.910	3.0	2005.03 - 2008.12	thermisch, Europa Ausführung	4490.87D
E 320 CDI	OM 642.910	3.0	2005.03 - 2008.12	elektrisch, Japan, USA	4835.87D
E 350	M 272.964, M 272.967, M 272.972	3.5	2004.08 - 2009.07		4834.100D
E 350 CGI	M 272.985	3.5	2007.09 - 2008.12		4834.100D
E 400 CDI	OM 628.961	4.0	2003.02 - 2008.12		4309.92D
E 500	M 113.967, M 113.969	5.0	2002.03 - 2009.07		4281.87D
E 500	M 273.960, M 273.962	5.5	2006.04 - 2009.07		4829.100D ▲

### E-Klasse (212)

E 200 CGI	M 271.820, M 271.860	1.8	2009.08 -		410389.103D ▲
E 200 NGT	M 271.958	1.8	2011.03 -		3457.90D
E 250 CGI	M 271.860	1.8	2009.01 -		410389.103D ▲
E 300	M 272.952	3.0	2009.01 -		4834.100D
E 300 CDI	OM 642.850	3.0	2009.11 -		4490.87D
E 350	M 272.977, M 272.980	3.5	2009.01 -		4834.100D
E 350 BlueTEC	OM 642.850	3.0	2009.01 -		4490.87D
E 350 CDI	OM 642.850, OM 642.856	3.0	2009.01 -		4490.87D
E 350 CGI	M 272.982, M 272.983	3.5	2009.01 -		4834.100D
E 500	M 273.970, M 273.971	5.5	2009.01 -		4833.100D

### G-Klasse (460)

230 G	M 115.973	2.3	1979.03 - 1993.07		4078.87D
230 GE	M 102.979, M 102.981, M 102.987, M 102.989	2.3	1982.04 - 1992.08		4078.87D
240 GD	OM 616.936	2.4	1979.03 - 1987.08		4117.80D
250 GD	OM 602.930	2.5	1987.10 - 1992.12		4176.85D
280 GE	M 110.994	2.7	1979.11 - 1989.08		4078.87D
300 GD	OM 603.912	3.0	1979.03 - 1993.07		4176.85D
300 GD	OM 617.931	3.0	1979.12 - 1991.12		4049.80D

### G-Klasse (461)

230 GE	M 102.979, M 102.996, M 102.997	2.3	1993.06 -		4078.87D
250 GD	OM 602.939	2.5	1990.02 -		4176.85D
290 GD / G 290 D	OM 602.942	2.9	1992.04 -		4176.85D
G 280 CDI	OM 642.884	3.0	2009.04 -		4490.87D
G 290 TD	OM 602.983	2.9	1997.07 -		4176.85D
G 300 CDI	OM 642.884	3.0	2010.04 -		4490.87D

### G-Klasse (463)

230 GE	M 102.989	2.3	1990.06 - 1993.06		4078.87D
300 GD	OM 603.931	3.0	1989.09 - 1997.09		4176.85D
300 GE	M 103.987	3.0	1989.09 - 1997.09		4078.87D
320 GE	M 104.996	3.2	1994.09 - 1997.11		4078.87D
350 G Turbo-D	OM 603.972	3.4	1991.09 - 1997.09		4176.80D
350 Turbo GD	OM 603.972	3.4	1991.09 -		4176.80D
G 300 TD	OM 606.964	3.0	1996.08 -	ohne Gehäuse	4176.80D
G 300 TD	OM 606.964	3.0	1996.08 -	mit Gehäuse	4280.80D
G 320	M 104.996	3.2	1994.09 - 1997.12		4078.87D
G 320	M 112.945	3.2	1997.07 -		4281.87D
G 320 CDI	OM 642.970	3.0	2006.09 -		4490.87D

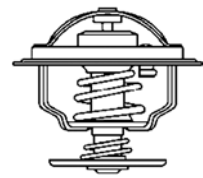

# MERCEDES-BENZ

	Engine	Ltr.	Year	Restriction*	Thermostat
G 400 CDI	OM 628.962	4.0	2000.12 -		4309.92D
G 500	M 113.962	5.0	1998.04 -		4281.87D
G 500	M 273.963	5.5	2009.12 -		4833.100D
G 500 E	M 117.965	5.0	1993.09 -		4137.80D
G 55 AMG	M 113.982, M 113.993	5.4	1999.04 -		4281.87D
<b>GLK-Klasse (X204)</b>					
280	M 272.948	3.0	2008.06 - 2009.06		4834.100D
300	M 272.948	3.0	2009.07 - 2011.04		4834.100D
320 CDI	OM 642.961	3.0	2008.06 -	thermisch	4490.87D
320 CDI	OM 642.961	3.0	2008.06 -	elektrischgesteuert	4835.87D
350	M 272.971, M 272.991	3.5	2008.06 - 2011.04		4834.100D
<b>GL-Klasse (X164)</b>					
GL 320 CDI	OM 642.940	3.0	2006.09 - 2009.05		4490.87D
GL 350 CDI	OM 642.822, OM 642.940	3.0	2009.05 -		4490.87D
GL 350 CDI BlueTEC	OM 642.820	3.0	2009.12 -		4490.87D
GL 450	M 273.923	4.7	2006.09 -		4833.100D
GL 500	M 273.963	5.5	2006.09 -		4833.100D
<b>MB 100 (631)</b>					
D	OM 616	2.4	1988.02 - 1996.02		4049.80D1
<b>M-Klasse (163)</b>					
ML 230	M 111.977	2.3	1998.02 - 2005.06		4275.87D
ML 320	M 112.942	3.2	1998.02 - 2002.08		4281.87D
ML 350	M 112.970	3.7	2002.08 - 2005.06		4281.87D
ML 400 CDI	OM 628.963	4.0	2001.09 - 2005.06		4309.92D
ML 430	M 113.942	4.3	1998.02 - 2005.06		4281.87D
ML 500	M 113.964, M 113.965	5.0	2001.09 - 2005.06		4281.87D
ML 55 AMG	M 113.981	5.4	2000.02 - 2005.06		4281.87D
<b>M-Klasse (164)</b>					
ML 280 CDI	OM 642.940	3.0	2005.07 - 2009.07		4490.87D
ML 300 CDI	OM 642.940	3.0	2009.07 -		4490.87D
ML 300 CDI	OM 642.820	3.0	2010.02 -		4490.87D
ML 320 CDI	OM 642.940	3.0	2005.07 - 2009.07		4490.87D
ML 350	M 272.967	3.5	2005.07 -		4834.100D
ML 350 CDI	OM 642.940	3.0	2009.07 -		4490.87D
ML 350 CDI BLUETEC SCR	OM 642.820	3.0	2009.09 -		4490.87D
ML 500	M 113.964	5.0	2005.07 -		4281.87D
ML 500	M 273.963	5.5	2007.12 -		4834.100D
<b>Pullmann (100)</b>					
600	M 100.982, M 100.980	6.3	1964.09 - 1979.01		4078.79D
<b>R-Klasse (251)</b>					
R 280	M 272.945	3.0	2007.01 -		4834.100D
R 280 CDI	OM 642.870, OM 642.950	3.0	2006.05 -		4490.87D
R 300	M 272.945	3.0	2009.07 -		4834.100D
R 300 CDI	OM 642.870, OM 642.950	3.0	2006.01 -		4490.87D
R 300 CDI	OM 642.950	3.0	2009.07 -		4490.87D
R 320 CDI	OM 642.870, OM 642.950,	3.0	2006.01 -		4490.87D
R 350	M 272.967	3.5	2006.01 -		4834.100D

# Thermostats

## MERCEDES-BENZ

	Engine	Ltr.	Year	Restriction*	Thermostat
R 350 CDI	OM 642.870, OM 642.950	3.0	2006.01 -		4490.87D
R 350 CDI	OM 642.950	3.0	2009.07 -		4490.87D
R 500	M 113.971	5.0	2006.01 -		4281.87D
R 500	M 273.963	5.5	2007.01 -		4833.100D
<b>S-Klasse (108/109)</b>					
250 S	M 108.920	2.5	1966.01 - 1969.12		4078.87D
250 SE	M 129.980	2.5	1966.01 - 1967.12		4078.87D
280 S	M 130.920	2.8	1967.10 - 1972.07		4078.87D
280 SE, SEL	M 130.980	2.8	1968.01 - 1972.08		4078.87D
280 SE, SEL 3.5	M 116.980	3.5	1971.03 - 1972.08		4078.87D
300 SEL	M 130.981	2.7	1968.01 - 1972.08		4078.87D
300 SEL 3.5	M 116.981	3.5	1970.01 - 1972.07		4064.75D
300 SEL 6.3	M 100.981	6.3	1968.03 - 1972.08		4078.79D
<b>S-Klasse (116)</b>					
280 S	M 110.922	2.7	1972.08 - 1980.07		4078.87D
280 SE, SEL	M 110.983, M 110.985	2.7	1972.08 - 1980.07		4078.87D
350 SE, SEL	M 116.983, M 116.985	3.5	1972.08 - 1976.02		4064.75D
450 SE, SEL	M 117.983, M 117.985, M 117.986	4.5	1973.01 - 1980.04		4064.75D
450 SEL 6.9	M 100.985	6.8	1975.07 - 1980.03		4078.87D
<b>S-Klasse (126)</b>					
260 SE	M 103.941	2.6	1985.09 - 1991.06		4078.87D
280 S	M 110.926, M 110.924	2.7	1979.12 - 1985.07		4078.87D
280 SE, SEL	M 110.987, M 110.989	2.7	1979.10 - 1985.07		4078.87D
3.8	M 116.960	3.8	1980.08 - 1984.08		4064.75D
300 SE, SEL	M 103.981	3.0	1985.09 - 1991.06		4078.87D
380 SE, SEL	M 116.963	3.8	1979.12 - 1981.08		4064.75D
380 SE, SEL	M 116.963	3.8	1981.09 - 1985.08		4233.84D
380 SE, SEL	M 116.961	3.8	1985.12 - 1986.12		4137.80D
380 SEC	M 116.963	3.8	1981.10 - 1985.07		4233.84D
420 SE, , SEC, SEL	M 116.965	4.2	1985.10 - 1991.06		4137.80D
500 SE, SEL	M 117.961, M 117.963	5.0	1979.12 - 1981.08		4064.75D
500 SE, SEL	M 117.961, M 117.963	5.0	1981.09 - 1985.08		4233.84D
500 SE, SEL	M 117.965	5.0	1985.09 - 1991.06		4137.80D
500 SEC	M 117.963	5.0	1981.10 - 1985.08		4233.84D
500 SEC	M 117.965	5.0	1985.09 - 1991.06		4137.80D
560 SE, SEL	M 117.968	5.5	1985.10 - 1991.06		4137.80D
560 SEC	M 117.968	5.5	1985.10 - 1991.06		4137.80D
<b>S-Klasse (140)</b>					
300 SE 2.8	M 104.944	2.8	1993.01 - 1998.10		4078.87D
300 SE, SEL / S 320	M 104.990, M 104.994	3.2	1991.03 - 1998.10		4078.87D
400 SE, SEL / S 420	M 119.971	4.2	1991.02 - 1998.10	Motor no. →026750	4137.80D
400 SE, SEL / S 420	M 119.971	4.2	1991.03 - 1998.10	Motor no. 026751→	4278.80D
500 SE, SEL	M 119.970	5.0	1991.02 - 1998.10	Motor no. →056885	4137.80D
500 SE, SEL	M 119.970	5.0	1991.03 - 1998.10	Motor no. 056885→	4278.80D
600 SE, SEL	M 120.982, M 120.980	6.0	1991.04 - 1992.12		4517.87D
S 280	M 104.944	2.8	1993.02 - 1998.10		4078.87D
S 300 Turbo-D	OM 606.961	3.0	1996.05 - 1998.10	ohne Gehäuse	4176.80D
S 300 Turbo-D	OM 606.961	3.0	1996.05 - 1998.10	mit Gehäuse	4280.80D
S 320	M 104.990	3.2	1995.10 - 1998.08		4078.87D
S 350 Turbo-D	OM 603.971	3.4	1993.01 - 1998.10	ohne Gehäuse	4176.80D
S 350 Turbo-D	OM 603.971	3.4	1993.01 - 1998.10	mit Gehäuse	4280.80D

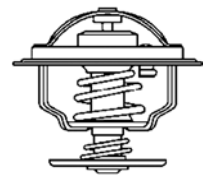

# MERCEDES-BENZ

	Engine	Ltr.	Year	Restriction*	Thermostat
S 420	M 119.971	4.2	1993.01 - 1998.10	Motor no. →056885	<b>4137.80D</b>
S 420	M 119.971	4.2	1993.02 - 1998.10	Motor no. 026751 →	<b>4278.80D</b>
S 500	M 119.970	5.0	1993.01 - 1998.10	Motor no. →056885	<b>4137.80D</b>
S 500	M 119.980	5.0	1993.01 - 1998.10		<b>4278.80D</b>
S 500	M 119.970	5.0	1993.02 - 1998.10	Motor no. 056886 →	<b>4278.80D</b>
S 600	M 120.982, M 120.980	6.0	1993.01 - 1998.10		<b>4517.87D</b>
SEC/CL 420	M 119.971	4.2	1994.10 - 1999.02	Motor no. →026750	<b>4137.80D</b>
SEC/CL 420	M 119.981	4.2	1994.10 - 1999.02		<b>4278.80D</b>
SEC/CL 420	M 119.971	4.2	1994.11 - 1999.02	Motor no. 026751 →	<b>4278.80D</b>
SEC/CL 500	M 119.970	5.0	1992.10 - 1999.02	Motor no. →056885	<b>4137.80D</b>
SEC/CL 500	M 119.970	5.0	1992.11 - 1999.02	Motor no. 056886 →	<b>4278.80D</b>
SEC/CL 600	M 120.982, M 120.980	6.0	1992.09 - 1999.02		<b>4517.87D</b>
<b>S-Klasse (215)</b>					
CL 500	M 113.960	5.0	1999.03 - 2006.03		<b>4281.87D</b>
CL 55 AMG	M 113.986	5.4	1999.10 - 2006.03		<b>4281.87D</b>
<b>S-Klasse (220)</b>					
S 280	M 112.922, M 112.944	2.8	1998.10 - 2005.08		<b>4281.87D</b>
S 320 CDI	OM 648.960	3.2	2002.09 - 2005.08	ohne Gewinde	<b>410174.92D</b>
S 320 CDI	OM 648.960	3.2	2002.09 - 2005.08	mit Gewinde	<b>411434.92D ▲</b>
S 350	M 112.972, M 112.975	3.7	2002.09 - 2005.08		<b>4281.87D</b>
S 400 CDI	OM 628.960	4.0	2000.06 - 2005.08		<b>4309.92D</b>
S 430	M 113.941, M 113.948	4.3	1998.10 - 2005.08		<b>4281.87D</b>
S 500	M 113.960, M 113.966	5.0	1998.10 - 2005.08		<b>4281.87D</b>
S 55 AMG	M 113.986	5.4	1999.04 - 2005.08		<b>4281.87D</b>
<b>S-Klasse (W221)</b>					
S 320 CDI	OM 642.930, OM 642.932	3.0	2005.10 - 2009.06	thermisch	<b>4490.87D</b>
S 320 CDI	OM 642.930, OM 642.932	3.0	2005.12 - 2009.06	elektrisch	<b>4835.87D</b>
S 350	M 272.965, M 272.975	3.5	2005.10 -		<b>4834.100D</b>
S 350 CDI	OM 642.930	3.0	2009.06 -	thermisch	<b>4490.87D</b>
S 350 CDI	OM 642.930	3.0	2009.06 -	elektrisch	<b>4835.87D</b>
S 400 Hybrid	M 272.974	3.5	2009.01 -		<b>4834.100D</b>
S 450	M 273.922, M 273.924	4.7	2005.12 -		<b>4833.100D</b>
S 500	M 273.961, M 273.968	5.5	2005.10 -		<b>4833.100D</b>
<b>S-Klasse Coupe (C216)</b>					
CL 500	M 273.961, M 273.968	5.5	2006.06 -		<b>4833.100D</b>
<b>SL (107)</b>					
280 SL	M 110.986, M 110.990, M 110.982	2.7	1974.08 - 1985.07		<b>4078.87D</b>
300 SL	M 103.982	3.0	1985.09 - 1989.08		<b>4078.87D</b>
350 SL	M 116.982, M 116.984	3.5	1971.05 - 1980.02		<b>4064.75D</b>
380 SL	M 116.960, M 116.962	3.8	1980.09 - 1981.08		<b>4064.75D</b>
420 SL	M 116.964	4.2	1986.01 - 1989.08		<b>4137.80D</b>
450 SL	M 117.982, M 117.985	4.5	1972.10 - 1980.10		<b>4064.75D</b>
450 SLC 5.0	M 117.960	5.0	1978.06 - 1980.02		<b>4278.80D</b>
500 SL	M 117.960, M 117.964	5.0	1980.05 - 1985.12		<b>4278.80D</b>
<b>SL (129)</b>					
280	M 104.943	2.8	1993.08 - 2001.10		<b>4078.87D</b>
280	M 112.923, M 112.925	2.8	1998.05 - 2001.10		<b>4281.87D</b>
300 SL	M 103.984	3.0	1989.03 - 1993.08		<b>4078.87D</b>



# Thermostats

## MERCEDES-BENZ

	Engine	Ltr.	Year	Restriction*	Thermostat
300 SL-24	M 104.981	3.0	1989.03 - 1993.07		4078.87D
320	M 104.991	3.2	1993.09 - 2001.10		4078.87D
320	M 112.943	3.2	1998.05 - 2001.10		4281.87D
500	M 113.961	5.0	1998.05 - 2001.10		4281.87D
500 SL	M 119.960, M 119.972	5.0	1989.09 - 1992.08		4137.80D
500 SL	M 119.972	5.0	1989.09 - 2001.10	Motor no. →013777	4137.80D
500 SL	M 119.972	5.0	1989.10 - 2001.10	Motor no. 013778→	4278.80D
55 AMG	M 113.985	5.4	2000.03 - 2001.10		4281.87D
60 AMG	M 122.981	6.0	1997.05 - 2001.10		4517.87D
600	M 120.980, M 120.981, M 120.983	6.0	1992.07 - 2001.10		4517.87D
<b>SL (230)</b>					
280	M 272.949	3.0	2008.03 - 2012.01		4834.100D
300	M 272.949	3.0	2009.04 - 2012.01		4834.100D
350	M 112.973	3.7	2003.03 - 2012.01		4281.87D
350	M 272.966, M 272.968	3.5	2006.03 - 2012.01		4834.100D
500	M 113.963	5.0	2001.10 - 2012.01		4281.87D
500	M 273.965	5.5	2006.03 - 2012.01		4833.100D
<b>SLK (170)</b>					
200	M 111.946	2.0	1996.09 - 2000.03		4275.87D
200 Kompressor	M 111.943, M 111.958	2.0	1996.10 - 2004.04		4275.87D
230 Kompressor	M 111.973, M 111.983	2.3	1996.09 - 2004.04		4275.87D
32 AMG Kompressor	M 112.960	3.2	2001.03 - 2004.04		4298.87D
320	M 112.947	3.2	2000.03 - 2004.04		4281.87D
<b>SLK (171)</b>					
200 Kompressor	M 271.944, M 271.954	1.8	2004.03 - 2011.02		3457.90D
280	M 272.942	3.0	2005.03 - 2011.02	Motor no. 30058377→	4834.100D
300	M 272.942	3.0	2009.04 - 2011.02		4834.100D
350	M 272.963	3.5	2005.03 - 2011.02	Motor no. 30000484→	4834.100D
350	M 272.969	3.5	2008.01 - 2011.02		4834.100D
<b>SLK (R172)</b>					
200	M 271.860, M 271.861	1.8	2011.02 -		410389.103D ▲
250	M 271.860, M 271.861	1.8	2011.02 -		410389.103D ▲
<b>SPRINTER 2-t (901, 902)</b>					
208 CDI	OM 611.987	2.1	2000.04 - 2006.05	ohne Gewinde	410171.87D
208 CDI	OM 611.987	2.1	2000.04 - 2006.05	mit Gewinde	411433.87D ▲
208 D	OM 601.943	2.3	1995.01 - 2000.04	ohne Gehäuse	4176.85D
208 D	OM 601.943	2.3	1995.01 - 2000.04	mit Gehäuse	4280.85D
210 D	OM 602.980	2.9	1997.01 - 2000.04	ohne Gehäuse	4176.85D
210 D	OM 602.980	2.9	1997.01 - 2000.04	mit Gehäuse	4280.85D
211 CDI	OM 611.981	2.1	2000.04 - 2006.05	ohne Gewinde	410171.87D
211 CDI	OM 611.981	2.1	2000.04 - 2006.05	mit Gewinde	411433.87D ▲
212 D	OM 602.980	2.9	1995.02 - 2000.04	ohne Gehäuse	4176.85D
212 D	OM 602.980	2.9	1995.02 - 2000.04	mit Gehäuse	4280.85D
213 CDI	OM 611.981	2.1	2000.04 - 2006.05	ohne Gewinde	410171.87D
213 CDI	OM 611.981	2.1	2000.04 - 2006.05	mit Gewinde	411433.87D ▲
214	M 111.979, M 111.984	2.3	1995.02 - 2006.05		4275.87D
214 NGT	M 111.984	2.3	2000.04 - 2006.05		4275.87D
216 CDI	OM 612.981	2.7	2000.04 - 2006.05	ohne Gewinde	410171.87D
216 CDI	OM 612.981	2.7	2000.04 - 2006.05	mit Gewinde	411433.87D ▲

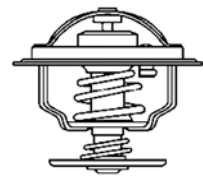

# MERCEDES-BENZ

	Engine	Ltr.	Year	Restriction*	Thermostat
<b>SPRINTER 3-t (903)</b>					
2.3 D	OM 601.943	2.3	1997.06 - 1999.12	ohne Gehäuse	4176.85D
2.3 D	OM 601.943	2.3	1997.06 - 1999.12	mit Gehäuse	4280.85D
2.9 TDi	OM 602.980	2.9	1997.01 - 1999.12	ohne Gehäuse	4176.85D
2.9 TDi	OM 602.980	2.9	1997.01 - 1999.12	mit Gehäuse	4280.85D
308 CDI	OM 611.987	2.1	2000.04 - 2006.05	ohne Gewinde	410171.87D
308 CDI	OM 611.987	2.1	2000.04 - 2006.05	mit Gewinde	411433.87D ▲
308 D	OM 601.943	2.3	1995.02 - 2000.04	ohne Gehäuse	4176.85D
308 D	OM 601.943	2.3	1995.02 - 2000.04	mit Gehäuse	4280.85D
308 D 2.3	OM 601.943	2.3	1995.02 - 2000.04	ohne Gehäuse	4176.85D
308 D 2.3	OM 601.943	2.3	1995.02 - 2000.04	mit Gehäuse	4280.85D
310 D	OM 602.980	2.9	1997.05 - 2002.08	ohne Gehäuse	4176.85D
310 D	OM 602.980	2.9	1997.05 - 2002.08	mit Gehäuse	4280.85D
310 D 2.9	OM 602.980	2.9	1995.02 - 2000.04	ohne Gehäuse	4176.85D
310 D 2.9	OM 602.980	2.9	1995.02 - 2000.04	mit Gehäuse	4280.85D
311 CDI	OM 611.981	2.1	2000.04 - 2006.05	ohne Gewinde	410171.87D
311 CDI	OM 611.981	2.1	2000.04 - 2006.05	mit Gewinde	411433.87D ▲
312 D 2.9	OM 602.980	2.9	1995.02 - 2002.08	ohne Gehäuse	4176.85D
312 D 2.9	OM 602.980	2.9	1995.02 - 2002.08	mit Gehäuse	4280.85D
313 CDI	OM 611.981	2.1	2000.04 - 2006.05	ohne Gewinde	410171.87D
313 CDI	OM 611.981	2.1	2000.04 - 2006.05	mit Gewinde	411433.87D ▲
314	M 111.979, M 111.984	2.3	1995.02 - 2006.05		4275.87D
314 NGT	M 111.984	2.3	2000.04 - 2006.05		4275.87D
316 CDI	OM 612.981	2.7	2000.04 - 2006.05	ohne Gewinde	410171.87D
316 CDI	OM 612.981	2.7	2000.04 - 2006.05	mit Gewinde	411433.87D ▲
<b>SPRINTER 4-t (904)</b>					
2.3 D	OM 601.943	2.3	1997.06 - 1999.12	ohne Gehäuse	4176.85D
2.3 D	OM 601.943	2.3	1997.06 - 1999.12	mit Gehäuse	4280.85D
408 CDI	OM 611.987	2.1	2000.04 - 2006.05	ohne Gewinde	410171.87D
408 CDI	OM 611.987	2.1	2000.04 - 2006.05	mit Gewinde	411433.87D ▲
408 D	OM 601.943	2.3	1996.02 - 2006.05	ohne Gehäuse	4176.85D
408 D	OM 601.943	2.3	1996.02 - 2006.05	mit Gehäuse	4280.85D
410 D	OM 602.980	2.9	1996.02 - 2006.05	ohne Gehäuse	4176.85D
410 D	OM 602.980	2.9	1996.02 - 2006.05	mit Gehäuse	4280.85D
411 CDI	OM 611.981	2.1	2000.04 - 2006.05	ohne Gewinde	410171.87D
411 CDI	OM 611.981	2.1	2000.04 - 2006.05	mit Gewinde	411433.87D ▲
412 D	OM 602.980	2.9	1996.02 - 2006.05	ohne Gehäuse	4176.85D
412 D	OM 602.980	2.9	1996.02 - 2006.05	mit Gehäuse	4280.85D
413 CDI	OM 611.981	2.1	2000.04 - 2006.05	ohne Gewinde	410171.87D
413 CDI	OM 611.981	2.1	2000.04 - 2006.05	mit Gewinde	411433.87D ▲
414	M 111.979	2.3	1996.02 - 2006.05		4275.87D
416 CDI	OM 612.981	2.7	2000.04 - 2006.05	ohne Gewinde	410171.87D
416 CDI	OM 612.981	2.7	2000.04 - 2006.05	mit Gewinde	411433.87D ▲
<b>SPRINTER 3,5-t (906)</b>					
309 CDI	OM 646.984	2.1	2006.06 -	ohne Gewinde	410171.87D
309 CDI	OM 646.984	2.1	2006.06 -	mit Gewinde	411433.87D ▲
311 CDI	OM 646.985	2.1	2006.06 -	ohne Gewinde	410171.87D
311 CDI	OM 646.985	2.1	2006.06 -	mit Gewinde	411433.87D ▲
313 CDI	OM 646.986	2.1	2006.06 -	ohne Gewinde	410171.87D
313 CDI	OM 646.986	2.1	2006.06 -	mit Gewinde	411433.87D ▲
315 CDI	OM 646.990, OM 646.989	2.1	2006.06 -	ohne Gewinde	410171.87D
315 CDI	OM 646.990, OM 646.989	2.1	2006.06 -	mit Gewinde	411433.87D ▲
316	M 271.951	1.8	2008.09 -		3457.90D
316 NGT	M 271.951	1.8	2008.09 -		3457.90D

# Thermostats

## MERCEDES-BENZ

	Engine	Ltr.	Year	Restriction*	Thermostat
318 CDI	OM 642.992, OM 642.993	3.0	2006.06 -		410055.87D ▲
318 CDI	OM 642.896	3.0	2006.06 -		4490.87D
319 CDI / BlueTEC	OM 642.992	3.0	2009.03 -		410055.87D ▲
319 CDI / BlueTEC	OM 642.896, OM 642.898	3.0	2009.03 -		4490.87D
324	M 272.979	3.5	2006.06 -		4833.100D
<b>SPRINTER 3-t (906)</b>					
209 CDI	OM 646.984	2.1	2006.06 -	ohne Gewinde	410171.87D
209 CDI	OM 646.984	2.1	2006.06 -	mit Gewinde	411433.87D ▲
211 CDI	OM 646.985	2.1	2006.06 -	ohne Gewinde	410171.87D
211 CDI	OM 646.985	2.1	2006.06 -	mit Gewinde	411433.87D ▲
213 CDI	OM 646.986	2.1	2006.06 -	ohne Gewinde	410171.87D
213 CDI	OM 646.986	2.1	2006.06 -	mit Gewinde	411433.87D ▲
215 CDI	OM 646.990, OM 646.989	2.1	2006.06 -	ohne Gewinde	410171.87D
215 CDI	OM 646.990, OM 646.989	2.1	2006.06 -	mit Gewinde	411433.87D ▲
216	M 271.951	1.8	2008.09 -		3457.90D
218 CDI	OM 642.992, OM 642.993	3.0	2006.06 -		410055.87D ▲
218 CDI	OM 642.896	3.0	2006.06 -		4490.87D
219 CDI / BlueTEC	OM 642.992	3.0	2009.03 -		410055.87D ▲
219 CDI / BlueTEC	OM 642.896	3.0	2009.03 -		4490.87D
224	M 272.979	3.5	2006.06 -		4833.100D
<b>SPRINTER 4,6 (906)</b>					
413 CDI	OM 646.986	2.1	2006.06 -	ohne Gewinde	410171.87D
413 CDI	OM 646.986	2.1	2006.06 -	mit Gewinde	411433.87D ▲
415 CDI	OM 646.990, OM 646.989	2.1	2006.06 -	ohne Gewinde	410171.87D
415 CDI	OM 646.990, OM 646.989	2.1	2006.06 -	mit Gewinde	411433.87D ▲
418 CDI	OM 642.992, OM 642.993	3.0	2006.06 -		410055.87D ▲
418 CDI	OM 642.896	3.0	2006.06 -		4490.87D
419 CDI	OM 642.992	3.0	2009.03 -		410055.87D ▲
419 CDI	OM 642.896, OM 642.898	3.0	2009.03 -		4490.87D
424	M 272.979	3.5	2006.06 -		4833.100D
<b>SPRINTER 5-t (906)</b>					
509 CDI	OM 646.984	2.1	2006.06 -	ohne Gewinde	410171.87D
509 CDI	OM 646.984	2.1	2006.06 -	mit Gewinde	411433.87D ▲
511 CDI	OM 646.985	2.1	2006.06 -	ohne Gewinde	410171.87D
511 CDI	OM 646.985	2.1	2006.06 -	mit Gewinde	411433.87D ▲
513 CDI	OM 646.986	2.1	2006.06 -	ohne Gewinde	410171.87D
513 CDI	OM 646.986	2.1	2006.06 -	mit Gewinde	411433.87D ▲
515 CDI	OM 646.990, OM 646.989	2.1	2006.06 -	ohne Gewinde	410171.87D
515 CDI	OM 646.990, OM 646.989	2.1	2006.06 -	mit Gewinde	411433.87D ▲
516	M 271.951	1.8	2008.09 -		3457.90D
516 NGT	M 271.951	1.8	2008.09 -		3457.90D
518 CDI	OM 642.992, OM 642.993	3.0	2006.06 -		410055.87D ▲
518 CDI	OM 642.896	3.0	2006.06 -		4490.87D
519 CDI / BlueTEC	OM 642.898, OM 642.992, OM 642.896	3.0	2009.03 -		410055.87D ▲
519 CDI / BlueTEC	OM 642.896, OM 642.898	3.0	2009.03 -		4490.87D
524	M 272.979	3.5	2006.06 -		4833.100D
<b>SPRINTER (905)</b>					
616 CDI	OM 612.981	2.7	2001.04 - 2006.05	ohne Gewinde	410171.87D
616 CDI	OM 612.981	2.7	2001.04 - 2006.05	mit Gewinde	411433.87D ▲

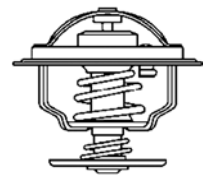

# MERCEDES-BENZ

	Engine	Ltr.	Year	Restriction*	Thermostat
<b>T1 (601, 602)</b>					
207 D 2.4	OM 616.917, OM 616.934	2.4	1977.12 - 1989.10		<b>4049.80D</b>
207 D 2.4	OM 616.937, OM 616.939	2.4	1977.12 - 1990.01		<b>4049.80D1</b>
208 2.3	M 115.972, M 115.955	2.3	1977.05 - 1982.12		<b>4078.87D</b>
208 D 2.3	OM 601.940	2.3	1987.10 - 1996.02	ohne Gehäuse	<b>4176.85D</b>
208 D 2.3	OM 601.940	2.3	1987.10 - 1996.02	mit Gehäuse	<b>4280.85D</b>
209 D 2.9	OM 617.913	3.0	1982.12 - 1990.01		<b>4049.80D1</b>
210 2.3	M 102.942, M 102.945, M 102.946	2.3	1977.04 - 1996.02		<b>4078.87D</b>
210 2.3	M 115.955	2.3	1977.04 - 1989.10		<b>4078.87D</b>
210 D 2.8	OM 602.940	2.9	1987.10 - 1996.02		<b>4176.85D</b>
210 D 2.9	OM 602.940	2.9	1988.11 - 1996.02		<b>4176.85D</b>
307 D 2.4	OM 616.917	2.4	1977.01 - 1990.12		<b>4117.80D</b>
307 D 2.4	OM 616.937, OM 616.939	2.4	1977.04 - 1990.01		<b>4049.80D1</b>
308 D 2.3	OM 601.940	2.3	1988.11 - 1996.02	ohne Gehäuse	<b>4176.85D</b>
308 D 2.3	OM 601.940	2.3	1988.11 - 1996.02	mit Gehäuse	<b>4280.85D</b>
309 D 3.0	OM 617.913	3.0	1982.10 - 1990.01		<b>4049.80D1</b>
310 D 2.9	OM 602.940	2.9	1989.06 - 1996.02		<b>4176.85D</b>
<b>T1 / TN</b>					
407 D	OM 616.913, OM 616.939	2.4	1981.07 - 1989.01		<b>4049.80D1</b>
408 D	OM 601.940	2.3	1988.11 - 1995.06	ohne Gehäuse	<b>4176.85D</b>
408 D	OM 601.940	2.3	1988.11 - 1995.06	mit Gehäuse	<b>4280.85D</b>
409 D	OM 617.913	3.0	1982.04 - 1989.01		<b>4049.80D1</b>
410	M 102.942, M 102.945	2.3	1982.08 - 1995.06		<b>4078.87D</b>
410 D	OM 602.940	2.9	1988.11 - 1995.06		<b>4176.85D</b>
<b>T2</b>					
L 405 D	OM 615	2.2	1972.01 - 1980.12		<b>4078.79D</b>
L 406 DG	OM 615.910	2.2	1968.01 - 1974.12		<b>4078.79D</b>
L 407 D	OM 616.910	2.4	1975.01 - 1988.12		<b>4078.79D</b>
L 407 D	OM 616.917	2.4	1975.01 - 1988.12		<b>4117.80D</b>
L 408 DG	OM 314.948	3.8	1970.01 - 1974.12		<b>4083.83D50</b>
L 408 G	M 115.1	2.0	1968.01 - 1972.12		<b>4078.87D</b>
L 408 G	M 115.921, M 115.928	2.2	1972.08 - 1974.12		<b>4105.83D</b>
L 409	M 115.952	2.3	1975.01 - 1982.08		<b>4105.83D</b>
L 410	M 102.943	2.3	1982.08 - 1988.12		<b>4078.87D</b>
L 508 DG	OM 314.946, OM 314.948	3.8	1970.01 - 1988.12		<b>4083.83D50</b>
L 608 D	OM 314.946, OM 314.948, OM 314.961, OM 314.963, OM 314.967	3.8	1970.01 - 1988.12		<b>4083.83D50</b>
L 613 D	OM 353.966, OM 353.963	5.7	1977.04 - 1988.12		<b>4083.83D50</b>
L 911	OM 352.906, OM 352.911, OM 352.989	5.7	1972.01 - 1983.07		<b>4083.83D50</b>
LF 408 G	M 115.927, M 115.929	2.2	1972.08 - 1974.12		<b>4105.83D</b>
LF 409 G	M 115.952, M 115.971, M 115.970	2.3	1975.01 - 1982.08		<b>4105.83D</b>
LK 408 G, LK 409	M 115.952	2.3	1975.01 - 1982.08		<b>4105.83D</b>
LK 408 G, LK 409	M 102.943	2.3	1982.08 - 1983.09		<b>4078.87D</b>
LK 911	OM 352.911	5.7	1972.01 - 1983.07		<b>4083.83D50</b>
LKO 508 DG	OM 314.946, OM 314.948, OM 314.961, OM 314.963, OM 314.959, OM 314.962	3.8	1972.06 - 1988.06		<b>4083.83D50</b>
LS 911	OM 352.911	5.7	1972.01 - 1983.07		<b>4083.83D50</b>
<b>T2 / LN1</b>					
507 D	OM 616.914	2.4	1986.04 - 1989.04		<b>4049.80D1</b>
508 D	OM 601.941	2.3	1989.03 - 1994.12		<b>4176.85D</b>
510	M 102.946	2.3	1986.04 - 1994.12		<b>4078.87D</b>
609 D	OM 364.906	4.0	1986.04 - 1994.12		<b>4105.83D</b>

# Thermostats

## MERCEDES-BENZ

Engine

Ltr.

Year

Restriction\*

Thermostat

609 D	OM 364.919	4.0	1986.04 - 1994.12		4105.83D
609 D	OM 354.902	4.0	1994.06 - 1994.12		4105.83D
611 D	OM 354.901	4.0	1994.06 - 1994.12		4105.83D
611 D	OM 354.902	4.0	1994.06 - 1994.12		4105.83D
709 D	OM 364.906	4.0	1986.04 - 1994.12		4105.83D
709 D	OM 364.906, OM 364.912, OM 364.921	4.0	1986.04 - 1994.12		4105.83D
711 D	OM 364.957, OM 354.902, OM 354.903	4.0	1986.04 - 1994.12		4105.83D
711 D	OM 364.950, OM 364.952	4.0	1986.04 - 1994.12		4105.83D
714 D	OM 354.923	4.0	1994.06 - 1994.12		4105.83D
809 D	OM 364.906, OM 364.911, OM 364.920, OM 364.921	4.0	1986.04 - 1994.12		4105.83D
811 D	OM 354.901, OM 354.903, OM 364.950, OM 364.952, OM 364.958	4.0	1986.04 - 1994.12		4105.83D
814 D	OM 354.924, OM 354.925	4.0	1987.11 - 1994.12		4105.83D
814 D	OM 364.981, OM 364.984, OM 364.986, OM 364.987	4.0	1987.11 - 1994.12		4105.83D
O 609 D	OM 364.913	4.0	1987.07 - 1992.12		4105.83D
O 611 D	OM 364.952, OM 364.954	4.0	1987.07 - 1992.12		4105.83D
O 614 D	OM 364.980, OM 364.981	4.0	1987.07 - 1992.12		4105.83D

## VANEO (414)

1.4	M 166.940	1.4	2002.06 - 2005.07		411576.87D ▲
1.6	M 166.961	1.6	2002.02 - 2005.07		411576.87D ▲
1.9	M 166.991	1.9	2002.02 - 2005.07		411576.87D ▲

## VARIO

512 D	OM 602.984	2.9	1996.09 -		4176.85D
612 D	OM 602.985, OM 602.984	2.9	1996.09 -		4176.85D
613 D, 614 D	OM 904.908, OM 904.917	4.2	1996.09 -		4105.83D
615 D, 616 D	OM 900.918, OM 904.923	4.2	1998.09 -		4105.83D
618 D	OM 900.919, OM 904.964	4.2	2006.09 -		4105.83D
810 DT	OM 904.904	4.2	1996.09 -		4105.83D
812 D	OM 602.985, OM 602.984	2.9	1996.09 -		4176.85D
813 D, 814 D	OM 900.917, OM 904.908	4.2	1996.09 -		4105.83D
814 DT	OM 904.908	4.2	1996.09 -		4105.83D
815 D, 816 D	OM 900.918, OM 904.923	4.2	1996.09 -		4105.83D
816 DT	OM 904.923	4.2	1996.09 -		4105.83D
818 D	OM 900.919, OM 904.964	4.2	2006.09 -		4105.83D
O 810	OM 904.904	4.2	1996.09 -		4105.83D
O 812	OM 602.985, OM 602.984	2.9	1996.09 -		4176.85D
O 814	OM 904.908	4.2	1996.09 -		4105.83D
O 815	OM 904.923	4.2	1996.09 -		4105.83D

## VIANO (639)

3.0	M 112.951	3.2	2003.09 -		4281.87D
3.2	M 112.951	3.2	2003.09 -		4281.87D
3.5	M 272.979	3.5	2007.09 -		4833.100D
3.7	M 112.976	3.7	2004.06 -		4281.87D
CDI 2.0	OM 646.982	2.1	2003.09 -	ohne Gewinde	410171.87D
CDI 2.0	OM 646.982	2.1	2003.09 -	mit Gewinde	411433.87D ▲
CDI 2.2	OM 646.982	2.1	2003.09 -	ohne Gewinde	410171.87D
CDI 2.2	OM 646.982	2.1	2003.09 -	mit Gewinde	411433.87D ▲
CDI 3.0	OM 642.990	3.0	2006.03 -		4832.87D ▲

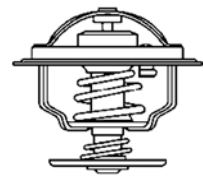

# MERCEDES-BENZ

	Engine	Ltr.	Year	Restriction*	Thermostat
<b>VITO (638)</b>					
108 CDI 2.2	OM 611A (60 KW CDI)	2.2	1999.03 - 2003.07	ohne Gewinde	<b>410171.87D</b>
108 CDI 2.2	OM 611A (60 KW CDI)	2.1	1999.03 - 2003.07	ohne Gewinde	<b>410171.87D</b>
108 CDI 2.2	OM 611A (60 KW CDI)	2.2	1999.03 - 2003.07	mit Gewinde	<b>411433.87D ▲</b>
108 CDI 2.2	OM 611A (60 KW CDI)	2.1	1999.03 - 2003.07	mit Gewinde	<b>411433.87D ▲</b>
110 CDI 2.2	OM 611LA (75 KW CDI)	2.1	1999.03 - 2003.07	ohne Gewinde	<b>410171.87D</b>
110 CDI 2.2	OM 611LA (75 KW CDI)	2.2	1999.03 - 2003.07	ohne Gewinde	<b>410171.87D</b>
110 CDI 2.2	OM 611LA (75 KW CDI)	2.2	1999.03 - 2003.07	mit Gewinde	<b>411433.87D ▲</b>
110 CDI 2.2	OM 611LA (75 KW CDI)	2.1	1999.03 - 2003.07	mit Gewinde	<b>411433.87D ▲</b>
112 CDI 2.2	OM 611.980	2.2	1999.03 - 2003.07	ohne Gewinde	<b>410171.87D</b>
112 CDI 2.2	OM 611.980	2.2	1999.03 - 2003.07	mit Gewinde	<b>411433.87D ▲</b>
113 2.0	M 111.948, M 111.950	2.0	1996.02 - 2003.07		<b>4279.87D</b>
114 2.3	M 111.978	2.3	1996.12 - 2003.07		<b>4279.87D</b>
<b>VITO (639)</b>					
109 CDI	OM 646.980, OM 646.981, OM 646.983	2.1	2006.09 -	ohne Gewinde	<b>410171.87D</b>
109 CDI	OM 646.980, OM 646.981, OM 646.983	2.1	2006.09 -	mit Gewinde	<b>411433.87D ▲</b>
111 CDI	OM 646.982	2.1	2003.09 -	ohne Gewinde	<b>410171.87D</b>
111 CDI	OM 646.982	2.1	2003.09 -	mit Gewinde	<b>411433.87D ▲</b>
115 CDI	OM 646.982	2.1	2003.09 -	ohne Gewinde	<b>410171.87D</b>
115 CDI	OM 646.982	2.1	2003.09 -	mit Gewinde	<b>411433.87D ▲</b>
119	M 112.951	3.2	2003.09 -		<b>4281.87D</b>
120 CDI	OM 642.990	3.0	2006.07 -		<b>4832.87D ▲</b>
122	M 112.951	3.2	2003.09 -		<b>4281.87D</b>
123	M 112.976	3.7	2004.06 - 2008.07		<b>4281.87D</b>
126	M 272.978	3.5	2007.09 -		<b>4833.100D</b>
<b>V-Klasse (638)</b>					
V 200	M 111.948, M 111.950	2.0	1997.02 - 2003.07		<b>4279.87D</b>
V 200 CDI	OM 611.980	2.2	1999.03 - 2003.07	ohne Gewinde	<b>410171.87D</b>
V 200 CDI	OM 611.980	2.2	1999.03 - 2003.07	mit Gewinde	<b>411433.87D ▲</b>
V 220 CDI	OM 611.980	2.2	1999.03 - 2003.07	ohne Gewinde	<b>410171.87D</b>
V 220 CDI	OM 611.980	2.2	1999.03 - 2003.07	mit Gewinde	<b>411433.87D ▲</b>
V 230	M 111.978	2.3	1996.10 - 2003.07		<b>4279.87D</b>
V 280	M 104.900	2.8	1997.08 - 2003.07		<b>4123.80D</b>

# Thermostats

## MG

Engine

Ltr.

Year

Restriction\*

Thermostat

### EXPRESS

1.4	14 K4F	1.4	2003.03 - 2005.05		410808.88D
1.8	18 K4F	1.8	2003.03 - 2005.05		410808.88D

### MG TF

115	16 K4F	1.6	2002.03 -		410808.88D
120	18 K4F	1.8	2002.03 -		410808.88D
135	18 K4F	1.8	2002.03 -		410808.88D
160	18 K4K	1.8	2002.03 -		410808.88D

### MG ZR

105	14 K4F	1.4	2001.06 - 2005.04		410808.88D
120	18 K4F	1.8	2001.06 - 2005.04		410808.88D
160	18 K4K	1.8	2001.06 - 2005.04		410808.88D

### MG ZS Hatchback

120	18 K4F	1.8	2001.07 - 2005.10		410808.88D
-----	--------	-----	-------------------	--	------------

### MG ZT

1.8 16V	18 K4F	1.8	2003.01 - 2005.07		410808.88D
1.8 T 16V	18 K4G	1.8	2003.01 - 2005.07		410806.88D

### MG ZT- T

1.8 16V	18 K4F	1.8	2003.01 - 2005.07		410808.88D
1.8 T 16V	18 K4G	1.8	2003.01 - 2005.07		410806.88D

### MGB Cabriolet

1.8		1.8	1966.01 - 1980.12		3004.82
-----	--	-----	-------------------	--	---------

### MGB GT

1.8		1.8	1966.01 - 1980.11		3004.82
-----	--	-----	-------------------	--	---------

### MGF (RD)

1.6	16 K4F	1.6	2000.02 - 2002.03		410808.88D
1.8 i 16V	18 K4F	1.8	1995.03 - 2002.03		410808.88D
1.8 i VVC	18 K4K	1.8	1995.03 - 2002.03		410808.88D

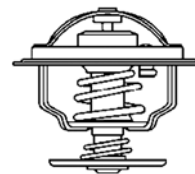

# MINI

	Engine	Ltr.	Year	Restriction*	Thermostat
<b>MINI (R50, R53)</b>					
1.4		1.4	2003.04 - 2006.09		<b>410263.91D</b>
Cooper	W10 B16 A	1.6	2001.06 - 2006.09		<b>410263.91D</b>
Cooper S	W11 B16 A	1.6	2002.03 - 2006.09		<b>410263.91D</b>
One	W10 B16 A	1.6	2001.06 - 2006.09		<b>410263.91D</b>
One D	1ND-TV	1.4	2003.06 - 2006.09		<b>410231.82D</b>
Works	W11 B16 A	1.6	2003.11 - 2006.09		<b>410263.91D</b>
<b>MINI Cabriolet (R52)</b>					
Cooper	W10 B16 A	1.6	2004.07 - 2007.11		<b>410263.91D</b>
Cooper S	W11 B16 A	1.6	2004.07 - 2007.11		<b>410263.91D</b>
John Cooper Works	W11 B16 A	1.6	2004.07 - 2007.11		<b>410263.91D</b>
One	W10 B16 A	1.6	2004.07 - 2007.11		<b>410263.91D</b>



# Thermostats

## MITSUBISHI

Engine

Ltr.

Year

Restriction\*

Thermostat

### CARISMA (DA\_)

1.6	4G92	1.6	1995.07 - 2006.06		4637.82D
1.8	4G93	1.8	1995.07 - 2005.06		4637.82D
1.8 16V	4G93	1.8	1995.07 - 2006.06		4637.82D
1.8 16V GDI	4G93 (GDI)	1.8	1997.09 - 2006.06		4637.82D
1.8 GDI	4G93 (GDI)	1.8	2000.10 - 2006.06		4637.82D
1.9 DI-D	F9Q1, F9Q2	1.9	2000.09 - 2006.06		3470.89D50
1.9 TD	F8QT	1.9	1996.10 - 2000.09		3470.89D50

### COLT I (A15\_A)

1.2	4G11	1.2	1978.12 - 1984.01		3119.82D4
1.4	4G12	1.4	1979.05 - 1984.01		3119.82D4
1.4 Turbo	4G12 T	1.4	1981.09 - 1984.01		3119.82D4

### COLT II (C1\_A)

1.2	4G16	1.2	1984.02 - 1988.04		3119.88D4
1.3	G13B	1.3	1985.06 - 1988.04		3119.88D4
1.5	4G15	1.5	1984.09 - 1988.04		3119.82D4
1.5	G15B	1.5	1985.09 - 1988.04		3119.82D4
1.6 Turbo ECi	4G32 T, C	1.6	1984.02 - 1988.04		3119.88D4
1.6 Turbo ECi	G32BT	1.6	1986.07 - 1988.04		3119.88D4

### COLT III (C5\_A)

1.3	4G13 (8V)	1.3	1988.04 - 1990.12		3119.82D4
1.3 12V	4G13 (12V)	1.3	1988.04 - 1992.05		3119.82D4
1.5	4G15 (12V)	1.5	1990.07 - 1992.05		3119.82D4
1.6 GTi 16V	4G61	1.6	1988.04 - 1990.05		3119.82D4
1.8 Diesel	4D65	1.8	1988.04 - 1992.05		3119.82D4
1.8 GTi 16V	4G67	1.8	1990.06 - 1992.05		3119.82D4

### COLT IV (CA\_A)

1.3 12V	4G13 (12V)	1.3	1992.04 - 1996.04		3119.82D4
1.6	4G92	1.6	1993.08 - 1996.04		4637.82D
1.6 16V	4G92	1.6	1992.04 - 1996.04		4637.82D
1.8 GTi 16V	4G93	1.8	1992.04 - 1996.04		4637.82D

### COLT LANCER (A7\_)

1.2	4G36	1.2	1978.01 - 1979.09		3119.82D4
1.4	4G33	1.4	1978.01 - 1979.09		3119.82D4
1.6	4G32 GS	1.6	1978.01 - 1979.09		3119.82D4

### COLT V (CJ\_, CP)

1.3	4G19	1.3	2002.08 - 2003.09		4637.82D
1300	4G13 (12V)	1.3	1996.05 - 2000.09		4637.82D
1500	4G15 (16V)	1.5	1995.11 - 2003.09		4637.76D
1600	4G92	1.6	1996.05 - 2003.09		4637.82D

### COLT VI (Z\_)

1.5	4G15T	1.5	2005.03 - 2012.06		4637.82D
-----	-------	-----	-------------------	--	----------

### COLT CZC Cabriolet (RG)

1.5	4A91	1.5	2006.05 - 2009.07		4637.82D
1.5 Turbo	4G15T	1.5	2006.05 - 2009.07		4637.82D

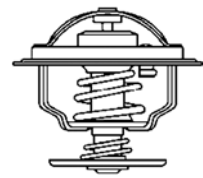

# mitsubishi

	Engine	Ltr.	Year	Restriction*	Thermostat
<b>CORDIA (A21_)</b>					
1.6	4G32	1.6	1982.10 - 1986.12		3119.82D4
1.6 Turbo	4G32 T	1.6	1982.10 - 1985.05		3119.82D4
1.8	4G37	1.8	1986.10 - 1986.12		3119.82D4
1.8 Turbo ECi	4G62 T	1.8	1984.10 - 1986.12		3119.82D4
<b>ECLIPSE I (D2_A)</b>					
2.0 i 16V	4G63 (DOHC 16V)	2.0	1991.04 - 1995.11		3119.82D4
<b>ECLIPSE II (D3_A)</b>					
2.0 Turbo	4G63 T (DOHC 16V)	2.0	1994.04 - 1999.04		4637.82D
2000 GT 16V		2.0	1995.12 - 1999.04		4637.82D
<b>ECLIPSE III (D5_A)</b>					
2.4	4G64 (SOHC 16V)	2.4	1999.05 - 2005.03		4637.82D
2.4 RS	4G64 (SOHC 16V)	2.4	1999.05 - 2005.03		4637.82D
3.0	6G72 (DOHC 24V)	3.0	1999.05 - 2005.03		410180.82D
<b>FTO Coupe (DE_A)</b>					
1.8	4G93	1.8	1994.09 - 2001.07		4637.82D
<b>GALANT II (A16_)</b>					
1.6	4G32	1.6	1980.09 - 1984.05		3119.82D4
2.0	4G63 (SOHC 8V)	2.0	1980.09 - 1984.05		3119.82D4
2.0 Turbo	4G63 T (ECI)	2.0	1982.05 - 1984.05		3119.82D4
<b>GALANT III (E1_A)</b>					
1.6 GLX	4G32	1.6	1984.06 - 1990.04		3119.82D4
1.8 Turbo-D (E14A)	4D65 T	1.8	1984.06 - 1990.04		4038.81D
2.0 GLS	4G63 (SOHC 8V)	2.0	1984.06 - 1990.04		3119.82D4
2.0 GLS	G63B	2.0	1985.06 - 1990.04		3119.82D4
2.0 Turbo ECi (E15A)	4G63 T (SOHC 8V)	2.0	1984.06 - 1990.04		3119.88D4
2.4 GLS (E16A)	G64B	2.4	1985.07 - 1990.04		3119.88D4
<b>GALANT IV (E3_A)</b>					
1.6	4G32, 4G37	1.6	1987.11 - 1992.10		3119.82D4
1.8 Turbo-D (E34A)	4D65 T	1.8	1987.12 - 1992.10		3119.82D4
2.0	4G63 (SOHC 8V)	2.0	1987.11 - 1992.10		3119.82D4
2.0 GTi 16V	4G63 (DOHC 16V)	2.0	1987.11 - 1992.12		3119.82D4
<b>GALANT V (E5_A, E7_A, E8_A)</b>					
1.8	4G93 (GDI)	1.8	1992.11 - 1996.08		4637.82D
1.8	4G93	1.8	1994.02 - 1996.08		4637.82D
2.0	4G63 (SOHC 8V)	2.0	1992.11 - 1996.08		4637.82D
2.0 GLSTD	4D68 T	2.0	1992.11 - 1996.08		4637.82D
2.0 V6-24	6A12	2.0	1992.11 - 1996.08		4637.82D
2.5	6G73	2.5	1992.11 - 1996.09		410180.82D
2.5 V6-24	6G73	2.5	1992.11 - 1996.08		410180.82D
<b>GALANT VI (EA_)</b>					
1.8 GDi	4G93 (GDI)	1.8	1997.11 - 2001.10		4637.82D
2.0	4G63 (SOHC 16V)	2.0	1996.09 - 2004.10		4637.82D

# Thermostats

## MITSUBISHI

	Engine	Ltr.	Year	Restriction*	Thermostat
2.0 GDi	4G94 (GDI)	2.0	1999.10 - 2004.10		4637.82D
2.0 TDI	4D68 (SOHC), 4D68 T	2.0	1996.09 - 2004.10		4637.82D
2.4	4G69	2.4	2003.10 - 2004.10		4637.82D
2.4 GDI	4G64 (GDI)	2.4	1999.02 - 2004.10		4637.82D
2.5 Type S		2.5	1999.10 - 2004.10		4637.82D
2.5 V6 24V	6A13, 6A13TT	2.5	1996.09 - 2004.10		4637.82D

## GALANT

2.0 GDi G	4G94 (GDI)	2.0	2003.10 -		4637.82D
2.4	4G69	2.4	2003.10 -		4637.82D
2.4 GDi Sport	4G69	2.4	2003.10 -		4637.82D

## GRANDIS

2.0 DI-D	BSY, BWC	2.0	2005.09 -		3472.87D
2.4	4G69	2.4	2004.04 -		4637.82D

## L 200 (K\_\_T)

2.0	4G63 (SOHC 8V)	2.0	1996.06 - 2007.12		4637.82D
2.4	4G64 (SOHC 16V)	2.4	1996.06 - 2007.12		4637.82D
2.4 i	4G64 (SOHC 16V)	2.4	1996.10 - 2006.12		4637.82D
2.5 D	4D56	2.5	1986.10 - 2007.12		4638.76D
2.5 TD	4D56 TD	2.5	1990.09 - 2007.12	55 mm Ø	4637.82D
2.5 TD	4D56 TD	2.5	1990.09 - 2007.12	54 mm Ø	4638.82D

## L 200 (KB\_T, KA\_T)

2.4 CNG	4G64 (SOHC 16V)	2.4	2010.04 -		4637.82D
2.4 i	4G64 (SOHC 16V)	2.4	2005.11 -		4637.82D

## L 300 (LO3\_P/G, LO\_2P)

1.6	4G32	1.6	1980.05 - 1987.02		3119.82D4
2.3 D	4D55	2.3	1983.04 - 1986.10		4038.81D
2.5 D	4D56 (8V)	2.5	1986.11 - 1994.04		4638.82D

## L 300 (P0\_W, P1\_W, P1\_T, P2\_W)

1.6 (P02V, P12V)	4G32	1.6	1986.11 - 1994.05		3119.82D4
2.0	4G63 (SOHC 8V)	2.0	1986.11 -		3119.82D4
2.0	4G63 (DOHC 16V)	2.0	1994.07 - 2000.04		4637.82D
2.0 (P03V, P13V)	G63B	2.0	1986.11 - 1994.05		3119.82D4
2.0 (P03V, P13V)	G63B	2.0	1994.06 -		4637.82D
2.4 (P04W, P14V, P04V)	4G64 (12V)	2.4	1990.11 -		3119.82D4
2.5 D	4D56 (8V)	2.5	1986.11 - 2006.02		4638.82D
2.5 TD	4D56 T	2.5	1988.11 - 2003.05	76° Variante	4638.76D
2.5 TD	4D56 T	2.5	1991.11 - 2003.05	82° Variante	4638.82D

## L 400 / Space Gear (PA, PB, PC, PD)

2.0	4G63 (DOHC 16V)	2.0	1995.09 - 2002.10		4637.82D
2.0	4G63 (SOHC 8V)	2.0	1996.06 - 2001.03		4637.82D
2.0 16V	4G63 (DOHC 16V)	2.0	1995.05 - 2000.05		4637.82D
2.4	4G64 (SOHC 16V)	2.4	1995.05 - 2002.10		4637.82D
2.4 i	4G64 (SOHC 16V)	2.4	1995.05 - 2000.05		4637.82D
2.5 TD	4D56 TD	2.5	1995.05 - 2000.05		4638.82D
2500 TD	4D56 T	2.5	1995.05 - 2005.06	55 mm Ø	4637.82D
2500 TD	4D56 T	2.5	1996.09 - 2005.06	54 mm Ø	4638.82D

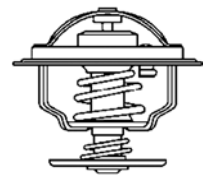

# MITSUBISHI

	Engine	Ltr.	Year	Restriction*	Thermostat
<b>LANCER I / F II (A17_)</b>					
1.2	4G11, 4G12	1.2	1979.09 - 1984.01		3119.82D4
1.4	4G12	1.4	1983.03 - 1984.01		3119.82D4
1.4 Turbo	4G12 T	1.4	1983.03 - 1984.01		3119.82D4
1.6	4G32 GS	1.6	1979.09 - 1983.02		3119.82D4
2.0 Turbo ECi	4G32 T (ECi)	2.0	1981.03 - 1983.02		3119.82D4
<b>LANCER III (C1, C3, C6)</b>					
1.2	4G16	1.2	1983.01 - 1988.04		3119.82D4
1.3	G13B	1.3	1988.05 - 1990.06		3119.88D4
1.3	4G13 (12V)	1.3	1990.07 - 1992.08		3119.88D4
1.5	4G15	1.5	1983.11 - 1990.12	82° Variante	3119.82D4
1.5	G15B	1.5	1985.06 - 1988.04	82° Variante	3119.82D4
1.5	G15B	1.5	1985.09 - 1989.08	88° Variante	3119.88D4
1.5	4G15 (12V)	1.5	1989.08 - 1992.08	88° Variante	3119.88D4
1.5 12V	4G15 (12V)	1.5	1990.09 - 1991.12		3119.82D4
1.8	4G37	1.8	1987.01 - 1992.06		3119.82D4
1.8	G37B	1.8	1987.01 - 1989.08		3119.88D4
1.8 D	4D65	1.8	1983.01 - 1992.06		3119.88D4
<b>LANCER IV (C6, C7)</b>					
1.2	4G16	1.2	1988.05 - 1992.08		3119.82D4
1.3	G13B, 4G13 (8V)	1.3	1988.05 - 1992.05		3119.82D4
1.3 12V	4G13 (12V)	1.3	1990.07 - 1994.05		3119.82D4
1.5	4G15	1.5	1988.04 - 1992.05		3119.82D4
1.5 12V	4G15 (12V)	1.5	1989.05 - 1992.05		3119.82D4
1.6	4G92	1.6	1992.06 - 1993.11		4637.76D
1.6 16V	4G92	1.6	1992.06 - 1994.05		3119.82D4
1.6 GLX	4G61	1.6	1989.08 - 1992.08		3119.82D4
1.6 GTi	4G61	1.6	1988.05 - 1990.05		3119.82D4
1.8	4G37	1.8	1989.09 - 1992.06		3119.82D4
1.8 Diesel	4D65	1.8	1988.04 - 1992.05		3119.82D4
1.8 GTi	4G37	1.8	1992.06 - 1993.07		3119.82D4
1.8 GTi 16V	4G67	1.8	1989.11 - 1993.12		3119.82D4
2.0 D	4D68	2.0	1992.06 - 1993.07		4637.76D
<b>LANCER V (CB, CD)</b>					
1.3	4G13 (12V)	1.3	1992.06 - 1996.12		3119.88D4
1.5	4G15 (12V)	1.5	1992.09 - 1996.07		3119.88D4
1.6	4G92	1.6	1994.02 - 1996.12		4637.82D
1.6 16V	4G92	1.6	1992.06 - 2003.10	76° Variante	4637.76D
1.6 16V	4G92	1.6	1992.12 - 2003.10	82° Variante	4637.82D
1.8	4G93	1.8	1995.03 - 2003.10		4637.82D
1.8 16V	4G93	1.8	1992.06 - 1993.12		4637.82D
1.8 i	4G93	1.8	1995.03 - 2003.10		4637.82D
2.0 D	4D68	2.0	1992.12 - 2003.10		4637.76D
2.0 D	4D68 T	2.0	1995.03 - 2003.10		4637.82D
2.0 Diesel	4D68	2.0	1992.06 - 1996.12		4637.82D
2.0 EVO I (CD9A)	4G63 Turbo	2.0	1992.10 - 1993.12		4637.82D
2.0 EVO II (CE9A)	4G63 Turbo	2.0	1994.01 - 1995.07		4637.82D
2.0 EVO III (CE9A)	4G63 Turbo	2.0	1995.08 - 1996.07		4637.82D
<b>LANCER VI (CJ-CP_)</b>					
1.3 12V	4G13 (12V)	1.3	1995.12 - 2003.08		4637.82D
1.5 16V	4G15 (16V)	1.5	1995.12 - 2003.08		4637.76D

# Thermostats

## MITSUBISHI

Engine

Ltr.

Year

Restriction\*

Thermostat

1.6 16V	4G92	1.6	1995.12 - 2003.08		4637.82D
1.8	4G93	1.8	1995.09 - 2003.08		4637.76D
1.8 16V	4G93T	1.8	1995.09 - 2003.08		4637.76D
2.0 16V EVO	4G63 Turbo	2.0	1996.08 - 2003.08		4637.82D

### LANCER (CS)

2.0	4G63 (DOHC 16V)	2.0	2003.09 - 2007.12		4637.82D
-----	-----------------	-----	-------------------	--	----------

### LANCER (CY/Z\_A)

2.0 DI-D	BKD, BWC	2.0	2008.01 -		3472.87D
----------	----------	-----	-----------	--	----------

### MIRAGE

1.2	4G16	1.2	1983.10 - 1988.01		3119.82D4
1.3	4G13 (12V)	1.3	1991.12 - 2003.07		4637.82D
1.5	4G15 (12V)	1.5	1991.12 - 1999.08		4637.82D
1.6	4G92	1.6	1991.12 - 2003.07		4637.82D
1.6		1.6	1995.09 - 1999.08		4637.82D
1.8	6A11	1.8	1991.12 - 2002.08		4637.82D
1.8	4G93	1.8	2001.08 - 2003.07		4637.82D

### LANCER SPORTBACK (CX\_A)

2.0 DI-D	BKD, BWC	2.0	2008.06 -		3472.87D
----------	----------	-----	-----------	--	----------

### OUTLANDER I (CU\_)

2.0	4G63 (DOHC 16V)	2.0	2003.05 - 2006.10		4637.82D
2.0	4G63 T (DOHC 16V)	2.0	2004.04 - 2006.10		4637.82D
2.4	4G64 (SOHC 16V), 4G69	2.4	2003.05 - 2006.10		4637.82D
2.4 GDI	4G64 (GDI)	2.4	2005.01 - 2006.12		4637.82D
2.4 HDD	4G69	2.4	2003.07 - 2006.09		4637.82D

### OUTLANDER II (CW\_W)

2.0 DI-D	BSY	2.0	2006.12 -		3478.82D
3.0	6B31	3.0	2006.11 -		410180.82D

### PAJERO I (L04\_G, L14\_G)

2.5 TD	4D56 T	2.5	1986.05 - 1991.12		4638.76D
2.6	4G54	2.6	1983.01 - 1990.11		3119.88D4
3.0 V6	6G72 (SOHC 12V)	3.0	1988.11 - 1990.11		3119.88D4

### PAJERO II (V2\_W, V3\_W, V4\_W)

1.8 GDI	4G93 (GDI)	1.8	1998.06 - 2000.04		4637.82D
2.4	4G64 (12V)	2.4	1991.04 - 2000.04		3119.88D4
2.5 TD	4D56 TD	2.5	1990.12 - 2000.04		4637.82D
2.8 TD	4M40-T	2.8	1994.06 - 1999.10		4637.76D
3.0 V6	6G72 (SOHC 12V)	3.0	1990.12 - 1995.12		3119.88D4
3.0 V6 24V	6G72 (SOHC 24V)	3.0	1994.06 - 2000.04		410180.82D
3.5 V6 24V	6G74 (DOHC 24V), 6G74 (SOHC 24V)	3.5	1994.06 - 1999.10		410180.82D

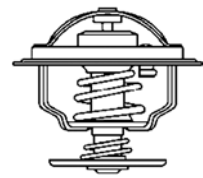

# mitsubishi

	Engine	Ltr.	Year	Restriction*	Thermostat
<b>PAJERO III (V6_W, V7_W)</b>					
2.5 TDi	4D56 T	2.5	2000.04 - 2006.12		4637.82D
3.2 DI-D	4M41	3.2	2000.04 - 2006.12		4637.76D
3.5 V6 GDI	6G74 (DOHC 24V), 6G74 (SOHC 24V)	3.5	2000.04 - 2006.12		410180.82D
<b>PAJERO IV (V8_W, V9_W)</b>					
3.8 V6	6G75	3.8	2007.02 - 2008.07		410180.82D
<b>PAJERO CLASSIC (V2_W)</b>					
2.5 TD	4D56 T	2.5	2002.07 -		4637.82D
3.2 DI-D	4M41	3.2	2005.05 -		4637.76D
<b>PAJERO PININ (H6_W, H7_W)</b>					
1.8	4G93	1.8	2001.11 - 2007.06		4637.82D
1.8 GDI	4G93 (GDI)	1.8	1999.10 - 2007.06		4637.82D
2.0 GDI	4G94 (GDI)	2.0	2000.10 - 2007.06		4637.82D
<b>PAJERO SPORT (K90)</b>					
2.5 TD	4D56 T	2.5	1997.11 - 2008.01		4637.82D
<b>PROUDIA / DIGNITY</b>					
3.5	6G74 (DOHC 24V)	3.5	1999.10 - 2001.05		410180.82D
4.5	8A80	5.0	1999.10 - 2001.05		410180.82D
<b>SANTAMO</b>					
2.0 16V	4G63 (DOHC 16V)	2.0	1999.05 - 2004.12		4637.82D
<b>SAPPORO I (A12_)</b>					
1.6	4G32	1.6	1978.04 - 1980.07		3119.82D4
2.0	4G52	2.0	1978.04 - 1980.07		3119.82D4
<b>SAPPORO II (A16_A)</b>					
1.6	4G32	1.6	1980.08 - 1984.09		3119.82D4
2.0	4G63 (SOHC 8V)	2.0	1980.08 - 1984.09		3119.82D4
2.0	4G63 (SOHC 8V)	2.0	1980.08 - 1983.08		3119.82D4
2.0 Turbo ECi	4G63 T (ECi)	2.0	1982.08 - 1983.08		3119.82D4
<b>SAPPORO III (E16A)</b>					
2.4	4G64 (8V)	2.4	1987.06 - 1990.08		3119.82D4
<b>SIGMA (F0_W, F1_A, F2_A)</b>					
3.0	6G72 (SOHC 12V)	3.0	1992.06 - 1996.10		410180.82D
3.0 V6	6G72 (SOHC 12V)	3.0	1990.12 - 1996.07		410180.82D
3.0 V6	6G72 (DOHC 24V)	3.0	1990.12 - 1996.07		410180.82D
<b>SPACE RUNNER (N1_W, N2_W)</b>					
1.8	4G93	1.8	1991.10 - 1999.08		4637.82D
2.0 16V	4G63 (DOHC 16V)	2.0	1997.06 - 1999.08		4637.82D
2.0 TD	4D68 T	2.0	1992.10 - 1999.08		4637.82D

# Thermostats

## MITSUBISHI

	Engine	Ltr.	Year	Restriction*	Thermostat
<b>SPACE RUNNER (N6_W)</b>					
2.0	4G63 (DOHC 16V)	2.0	1999.08 - 2002.08		4637.82D
2.4 GDI	4G64 (GDI)	2.4	1999.08 - 2002.08		4637.82D
<b>SPACE STAR (DG_A)</b>					
1.6	4G92	1.6	2001.04 - 2004.12		4637.82D
1.8 GDI	4G93 (GDI)	1.8	1998.06 - 2004.12		4637.82D
1.8 MPI	4G93	1.8	2002.10 - 2004.12		4637.82D
1.9 DI-D	F9Q1	1.9	2001.02 - 2004.12		3470.89D50
1.9 DI-D	F9Q2	1.9	2002.10 - 2004.12		3470.89D50
<b>SPACE WAGON (D0_V/W)</b>					
1.8	4G37	1.8	1983.01 - 1988.12		3119.82D4
2.0	4G63 (SOHC 8V)	2.0	1985.03 - 1991.04		3119.82D4
2.0	G63B	2.0	1985.06 - 1988.05		3119.82D4
<b>SPACE WAGON (N3_W, N4_W)</b>					
1.8	4G93	1.8	1991.10 - 1998.10		4637.82D
2.0	4G63 (SOHC 8V)	2.0	1991.05 - 1997.10		4637.82D
2.0	4G63 (DOHC 16V)	2.0	1992.10 - 1998.10		4637.82D
2.0 TD	4D68 T	2.0	1992.10 - 1998.10		4637.82D
2.4 i	4G64 (SOHC 16V)	2.4	1992.10 - 1998.10		4637.82D
<b>SPACE WAGON (N9_W, N8_W)</b>					
2.0 GDI	4G63 (SOHC 16V)	2.0	1998.10 - 2004.12		4637.82D
2.4 GDI	4G64 (GDI)	2.4	1998.10 - 2004.12		4637.82D
<b>STARION (A18_A)</b>					
2.0 Turbo	4G63 T (ECI)	2.0	1982.06 - 1985.12		3119.82D4
2.0 Turbo	4G63 T, C	2.0	1985.05 - 1987.08		3119.82D4
2.6 Turbo ECi	G54B T, C	2.6	1987.09 - 1990.06		3119.82D4
<b>TREDIA (A21_)</b>					
1.4 GLX	4G12	1.4	1982.10 - 1985.08		3119.82D4
1.6 GLS	4G32	1.6	1982.09 - 1987.10		3119.82D4
1.6 Turbo	4G32 T	1.6	1982.09 - 1985.05		3119.82D4

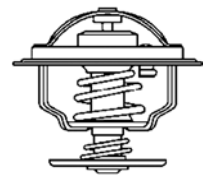

# NISSAN

	Engine	Ltr.	Year	Restriction*	Thermostat
<b>100 NX (B13)</b>					
1.6	GA16DS	1.6	1990.03 - 1994.10		4634.76
1.6 SR	GA16DE	1.6	1993.09 - 1994.10		3478.82D
2.0	SR20DE	2.0	1990.10 - 1994.10		4635.76
2.0 GTI	SR20DE	2.0	1991.03 - 1994.10		4635.76
<b>200 SX (S13)</b>					
1.8	CA18DE	1.8	1988.09 - 1994.03		3118.82D1
1.8 Turbo	CA18DET	1.8	1988.07 - 1993.11		3118.82D1
1.8 Turbo	CA18DT	1.8	1992.01 - 1994.09		3118.82D1
2.0 i 16V	SR20DE	2.0	1988.07 - 1993.11		4635.76
<b>200 SX (S14)</b>					
2.0 i 16V	SR20DE	2.0	1993.10 - 1999.12		4635.76
2.0 i 16V Turbo	SR20DET	2.0	1993.10 - 1999.12		4635.76
<b>280 ZX,ZXT (HGS130)</b>					
2.8	L28E	2.8	1978.10 - 1984.02		3118.88D1
2.8	L28ET	2.8	1983.01 - 1984.02		3118.88D1
<b>AD Wagon</b>					
1.5	QG15DE	1.5	1999.05 - 2004.08		3478.82D
1.6	GA16DS	1.6	1990.10 - 1999.04		3478.82D
1.6	GA16DE	1.6	1999.05 - 2004.08		3478.82D
1.8	QG18DE	1.8	1999.05 - 2004.08		3478.82D
<b>ALMERA I (N15)</b>					
1.4	GA14DE	1.4	1995.09 - 2000.07		3478.82D
1.5	GA15DE	1.5	1995.07 - 2000.05		3478.82D
1.6	GA16DE	1.6	1995.07 - 2000.07		3478.82D
2.0 D	CD20	2.0	1995.11 - 2000.07		410176.82D0
2.0 GTi	SR20DE	2.0	1996.07 - 2000.03		4635.76
<b>ALMERA II (N16)</b>					
1.5	QG15DE	1.5	2000.03 -		3478.82D
1.5 dCi	K9K 722	1.5	2003.01 -		411043.89D
1.6	GA16DE, QG16DE	1.6	2000.07 - 2003.02		3478.82D
1.8	QG18DE	1.8	2000.01 -		3478.82D
<b>ALMERA TINO (V10)</b>					
1.8	QG18DE	1.8	2000.08 -		3478.82D
2.0	SR20DE	2.0	2000.08 -		3478.82D
<b>BLUEBIRD (910)</b>					
1.6	L16	1.6	1980.01 - 1983.11		3118.88D1
1.8	L18S, L18T	1.8	1980.01 - 1984.05		3118.88D1
1.9 i	Z20E	1.9	1982.01 - 1984.05		3118.88D1
2.0	L20B	2.0	1981.05 - 1985.03		3118.82D1
2.0 D	LD20	2.0	1980.01 - 1984.05		4022.82D
2.0 i	Z20E	2.0	1982.01 - 1983.12		3118.88D1



# Thermostats

## NISSAN

	Engine	Ltr.	Year	Restriction*	Thermostat
<b>BLUEBIRD (T72 , T12)</b>					
1.6	CA16S	1.6	1986.03 - 1991.06		3118.88D1
1.8		1.8	1986.05 - 1992.11		3118.88D1
1.8 i 16V	CA18D	1.8	1989.02 - 1990.12		3118.88D1
1.8 Turbo	CA18T	1.8	1985.12 - 1992.11		3118.88D1
2.0	CA20S	2.0	1985.12 - 1990.02		3118.82D1
2.0 D	LD20	2.0	1986.03 - 1990.12		4022.82D
2.0 i	CA20E	2.0	1985.12 - 1990.12		3118.88D1
<b>BLUEBIRD (U11)</b>					
1.6	CA16S	1.6	1985.12 - 1990.02		3118.82D1
1.8	CA18N, CA18S	1.8	1983.11 - 1990.04		3118.82D1
1.8 Turbo	CA18ET, CA18T	1.8	1984.04 - 1990.05	82° Variante	3118.82D1
1.8 Turbo	CA18ET, CA18T	1.8	1984.04 - 1990.05	88° Variante	3118.88D1
2.0	CA20S	2.0	1985.12 - 1990.09		3118.88D1
2.0 D	LD20	2.0	1984.04 - 1990.12		4022.82D
2.0 i	CA20E	2.0	1984.04 - 1990.12		3118.88D1
<b>CHERRY (E10, N10)</b>					
1.0	A10	1.0	1970.09 - 1981.07		3118.82D1
1.0	A10S	1.0	1978.08 - 1981.07		3044.90D1
1.0	E10	1.0	1981.08 - 1982.05		3044.90D1
1.2	A12	1.2	1978.08 - 1981.07		3118.82D1
1.3	E13	1.3	1981.08 - 1983.12		3118.82D1
1.4	A14, A14S	1.4	1978.08 - 1981.07		3118.82D1
1.4 i.e.	A14S	1.4	1980.08 - 1981.07		3118.82D1
1.5	E15	1.5	1981.08 - 1982.12		3118.82D1
<b>CHERRY III (N12)</b>					
1.0	E10	1.0	1982.05 - 1986.05		3044.90D1
1.3	E13	1.3	1982.05 - 1986.10		3118.82D1
1.5	E15S	1.5	1983.11 - 1986.10		3118.82D1
1.5 ET Turbo	E15ET	1.5	1983.01 - 1985.12		3118.82D1
1.6	E16	1.6	1984.05 - 1986.07		3118.82D1
1.7 D	CD17	1.7	1982.10 - 1986.12		3118.82D1
<b>CUBE (Z11)</b>					
1.5	QG15DE	1.5	2003.01 - 2005.09		3478.82D
<b>CUBE (Z12)</b>					
1.5 dCi		1.5	2010.03 -		411442.83D ▲
1.6 16V	HR16DE	1.6	2010.03 -		411241.82D
<b>INTERSTAR (X70)</b>					
dCi 80	F9Q 772	1.9	2002.07 -		410517.83D
<b>JUKE</b>					
1.5 dCi		1.5	2010.06 -		411442.83D ▲
1.6	HR16DE	1.6	2010.06 -		411241.82D
1.6 DIG-T	MR16DDT	1.6	2010.06 -		411241.82D

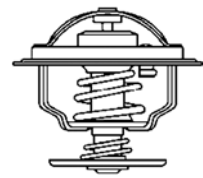

# NISSAN

	Engine	Ltr.	Year	Restriction*	Thermostat
<b>KUBISTAR</b>					
1.2	D7F 764	1.2	2003.08 -		3174.89D
1.2 16V	D4F 712	1.2	2006.04 -		3166.89D
1.5 dCi	K9K 722	1.5	2003.08 -	mit Rußpartikelfilter	411039.83D
1.5 dCi	K9K 704, K9K 710	1.5	2003.08 -		411043.89D
1.5 dCi	K9K 722	1.5	2003.08 -	ohne Rußpartikelfilter	411043.89D
1.5 dCi 70	K9K 700	1.5	2006.04 -		411043.89D
1.5 dCi 85	K9K 276	1.5	2006.04 -	Katalysatorart	411039.83D
1.5 dCi 85	K9K 276	1.5	2006.04 -	Katalysatorart	411043.89D
1.6 16V	K4M 752	1.6	2003.08 -	Deckel Thermostatgehäuse	126104 ▲
1.6 16V	K4M 752	1.6	2003.08 -		3466.89D
<b>LAUREL (JC32)</b>					
2.4	L24S, L24E	2.4	1985.01 - 1987.12		3118.82D1
2.8 D	LD28, RD28	2.8	1985.01 - 1989.12		4022.82D
<b>LUCINO</b>					
1.3	GA13DE	1.3	1996.11 - 2000.01		3478.82D
1.4	GA14DE	1.4	1991.09 - 2000.01		3478.82D
1.5	GA15DE	1.5	1997.11 - 2000.01		3478.82D
1.6	GA16DS	1.6	1991.09 - 1992.10		3478.82D
1.6	GA16DE	1.6	1992.10 - 2000.01		3478.82D
2.0 D	CD20	2.0	1997.11 - 2000.01		410176.82D0
<b>MICRA I (K10)</b>					
1.0	MA10S	1.0	1982.12 - 1991.05		3044.90D1
1.2	MA12S	1.2	1986.07 - 1992.07		3044.90D1
<b>MICRA II (K11)</b>					
1.0 i 16V	CG10DE	1.0	1992.08 - 2003.02		3004.82
1.3 i 16V	CG13DE	1.3	1992.08 - 2000.09		3004.82
1.4 i 16V	CGA3DE	1.4	2000.09 - 2003.02		3004.82
1.5 D	TD15	1.5	1998.02 - 2003.02		4821.89D
<b>MICRA III (K12)</b>					
1.0 16V	CG10DE	1.0	2003.01 - 2010.06		410488.88D
1.2 16V	CR12DE, CG12DE	1.2	2003.01 - 2010.06		410488.88D
1.4 16V	CR14DE	1.4	2003.01 - 2010.06		410488.88D
1.5 dCi	K9K 276, K9K 704, K9K 708	1.5	2003.01 - 2006.12		411040.83D
1.5 dCi	K9K 276, K9K 704, K9K 708	1.5	2006.12 - 2010.06		411442.83D ▲
1.6 160 SR	HR16DE	1.6	2005.08 -		411241.82D
160 SR	HR16DE	1.6	2005.05 - 2010.06		411241.82D
<b>MICRA IV (K13)</b>					
1.2	HR12DE	1.2	2010.05 -		411241.82D
1.2 DIG	HR12DDR	1.2	2011.04 -		411241.82D
<b>NOTE (E11)</b>					
1.4	CR14DE	1.4	2006.03 -		410488.88D
1.5 dCi	K9K 276, K9K 700	1.5	2006.03 - 2006.12		411040.83D
1.5 dCi	K9K 276, K9K 700	1.5	2006.12 -		411442.83D ▲
1.5 dCi	K9K 292	1.5	2008.07 -		411442.83D ▲
1.6	HR16DE	1.6	2006.03 -		411241.82D

# Thermostats

## NISSAN

	Engine	Ltr.	Year	Restriction*	Thermostat
<b>NV 200</b>					
1.5 dCi		1.5	2011.04 -		411442.83D ▲
1.6 16V	HR16DE	1.6	2010.02 -		411241.82D
<b>PATROL (160)</b>					
2.8	L28	2.8	1980.07 - 1988.08		3118.88D1
<b>PATROL (260)</b>					
2.8	L28	2.8	1986.05 - 1990.06		3118.88D1
<b>PICK UP (720)</b>					
1.8	L18	1.8	1983.01 - 1986.03		3118.88D1
2.2	Z22	2.2	1983.04 - 1986.03		3118.82D1
<b>PICK UP (D21)</b>					
2.0	Z20	2.0	1985.09 - 1991.08		3118.82D1
2.4 i 12V	KA24E	2.4	1992.04 - 1998.02		4635.76
<b>PICK UP (D22)</b>					
2.4 i	KA24DE, KA24E	2.4	1998.02 -		4635.76
<b>PRAIRIE (M10, NM10)</b>					
1.5 S	E15S	1.5	1984.01 - 1987.12		3118.82D1
1.8 SGL (M10)	CA18S	1.8	1983.07 - 1987.10		3118.82D1
2.0	CA20S	2.0	1986.06 - 1988.09		3118.88D1
<b>PRAIRIE PRO (M11)</b>					
2.0	CA20E	2.0	1989.03 - 1990.08		3118.88D1
2.0 i	CA20E	2.0	1988.10 - 1992.12		3118.88D1
2.4 i	KA24E	2.4	1992.04 - 1994.07		4635.76
<b>PRIMASTAR</b>					
1.9 dCi	F9Q 760	1.9	2002.07 - 2006.08		410517.83D
2.0	F4R 722, F4R 720	2.0	2001.03 -	Deckel Thermostatgehäuse	126104 ▲
2.0	F4R 722, F4R 720	2.0	2001.03 -		3466.89D
dCi 80	F9Q 762	1.9	2001.03 -		410517.83D
dCi 90	M9R 782	2.0	2006.09 -		411476.83D ▲
dCi 100	F9Q 760	1.9	2001.03 -		410517.83D
dCi 120	M9R 780	2.0	2006.09 -		411476.83D ▲
<b>PRIMERA (P10, WP10)</b>					
1.6	GA16DE, GA16DS	1.6	1990.06 - 1996.01		3478.82D
1.6 i	GA16DE, GA16DS	1.6	1990.06 - 1998.03		3478.82D
2.0	SR20DE	2.0	1990.06 - 1998.01		4635.76
2.0 16V	SR20DI	2.0	1990.06 - 1996.06		4635.76
2.0 D	CD20	2.0	1990.07 - 1996.01		410176.88D0
2.0 GT	SR20DE	2.0	1990.06 - 1996.01		4635.76
2.0 i	SR20DE SR20DI	2.0	1990.07 - 1998.03		4635.76

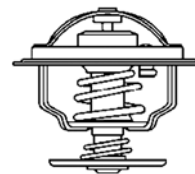

# NISSAN

	Engine	Ltr.	Year	Restriction*	Thermostat
<b>PRIMERA (P11, WP11)</b>					
1.6 16V	QG16DE	1.6	1996.06 - 2002.07		3478.82D
1.6 16V	GA16DE	1.6	1996.09 - 2002.07		3478.82D
1.8	QG18DD	1.8	1996.06 - 1999.05		3478.82D
1.8 16V	QG18DE	1.8	1999.08 - 2002.07		3478.82D
2.0	SR20VE	2.0	1996.06 - 1999.05		4635.76
2.0 16V	SR20DE	2.0	1996.06 - 2002.07		4635.76
2.0 TD	CD20T	2.0	1996.09 - 2002.07		410176.82D0
<b>PRIMERA (P12, WP12)</b>					
1.6	QG16DE	1.6	2002.01 -		3478.82D
1.8	QG18DE	1.8	2002.03 -		3478.82D
1.9 dCi		1.9	2002.08 -		410538.89D
<b>PULSAR</b>					
1.6	GA16DE	1.6	1992.10 - 2000.05		3478.82D
1.8	QG18DE	1.8	1995.07 - 2000.05		3478.82D
<b>QASHQAI (J10, JJ10)</b>					
1.5 dCi		1.5	2008.07 - 2009.07		411040.83D
1.5 dCi		1.5	2009.08 - 2010.01		411042.89D
1.5 dCi		1.5	2010.02 -		411442.83D ▲
1.6	HR16DE	1.6	2007.02 -		411241.82D
2.0	MR20DE	2.0	2007.02 -		411241.82D
2.0 dCi	M1D, M9R	2.0	2007.02 -		411475.89D ▲
<b>SERENA (C23M)</b>					
1.6	GA16DE	1.6	1994.10 - 2000.08		3478.82D
1.6 16V	GA16DE	1.6	1993.02 - 2001.09		3478.82D
2.0 16V	SR20DE	2.0	1992.11 - 2001.09		4635.76
2.0 D	LD20	2.0	1992.11 - 2001.09		410176.82D0
2.3 D	LD23	2.3	1995.01 - 2001.09		410176.82D0
<b>SERENA (C24)</b>					
2.0	SR20DE	2.0	2000.09 -		4635.76
<b>SILVIA (S12)</b>					
1.8	CA18ET	1.8	1986.07 - 1988.04		3118.88D1
2.0 GP	FJ20E	2.0	1984.04 - 1988.09		3118.82D1
<b>STANZA (T11)</b>					
1.6	CA16S	1.6	1981.08 - 1985.12		3118.82D1
1.8	CA18S, CA18	1.8	1981.08 - 1985.12		3118.82D1
<b>SUNNY I (B11)</b>					
1.3	E13	1.3	1982.03 - 1990.08		3118.82D1
1.5	E15, E15S	1.5	1982.03 - 1986.10		3118.82D1
1.6	E16, E16S	1.6	1984.05 - 1988.10		3118.82D1
1.7 D	CD17	1.7	1982.03 - 1986.10		3118.82D1

# NISSAN

	Engine	Ltr.	Year	Restriction*	Thermostat
<b>SUNNY II (B12, N13)</b>					
1.0	E10S	1.0	1986.07 - 1990.09		4272.90D
1.3	E13S	1.3	1986.06 - 1991.10		3118.82D1
1.4	GA14S	1.4	1988.10 - 1991.08		4634.76
1.5	E15S	1.5	1986.06 - 1988.10		3118.82D1
1.6	E16S, GA16DE, GA16S	1.6	1986.07 - 1988.10		3118.82D1
1.6		1.6	1988.10 - 1990.09		3118.82D1
1.6 GTI 16V	CA16D	1.6	1987.02 - 1989.05		3118.88D1
1.6 i	E16i	1.6	1986.06 - 1990.10		3118.82D1
1.6 i 12V	GA16i	1.6	1986.06 - 1991.06		4634.76
1.7 D	CD17	1.7	1986.01 - 1991.06		3118.82D1
1.8 GTI 16V	CA18D	1.8	1989.01 - 1991.06		3118.88D1
<b>SUNNY III (N14, Y10)</b>					
1.4	GA14DS	1.4	1990.10 - 1995.06		4634.76
1.4 i	GA14DE , GA14DS	1.4	1990.10 - 1995.05		4634.76
1.4 i 16V	GA14DE	1.4	1990.10 - 1995.06		3478.82D
1.5	QG15DE	1.5	1995.07 - 2000.03		3478.82D
1.6	GA16DEL	1.6	1992.01 - 1995.06		4634.76
1.6	GA16DE	1.6	1995.07 - 2000.03		3478.82D
1.6	QG16DE	1.6	2000.04 - 2003.09		3478.82D
1.6 16V	GA16DS	1.6	1990.11 - 1995.05		4634.76
1.6 i	GA16DE, GA16DEL, GA16DS	1.6	1990.10 - 2000.03		4634.76
1.6 i 16V	GA16DE, GA16DS	1.6	1990.10 - 2000.03		3478.82D
1.7 D	CD17	1.7	1990.11 - 2000.03		3118.82D1
1.8	QG18DE	1.8	2000.04 - 2003.09		3478.82D
2.0 D	CD20	2.0	1990.10 - 2000.03		410176.88D0
2.0 GTI-R	SR20DET	2.0	1990.10 - 1995.05		4635.76
2.0 i 16V	SR20DE	2.0	1990.10 - 1995.05		4635.76
<b>TERRANO I (WD21)</b>					
2.7 TD	TD27T	2.7	1989.02 - 1996.02		4022.82D
<b>TERRANO II (R20)</b>					
2.4	KA24E	2.4	1996.05 - 2002.01		4635.76
2.4 i 12V	KA24E	2.4	1993.02 - 1996.06		4635.76
2.7 TD	TD27T	2.7	1993.02 - 2002.01		4022.82D
<b>TIIDA (C11X, SC11X)</b>					
1.5	HR15DE	1.5	2004.05 - 2007.02		411241.82D
1.5 dCi	K9K 728	1.5	2007.09 -		411442.83D ▲
1.6	HR16DE	1.6	2007.09 -		411241.82D
<b>URVAN (E23)</b>					
2.0	Z20	2.0	1982.12 - 1988.11		3118.82D1
<b>URVAN (E24)</b>					
2.0	Z20	2.0	1987.05 - 1997.05		3118.82D1
<b>VANETTE (KC120)</b>					
1.5	A15	1.5	1983.01 - 1987.12		3118.82D1

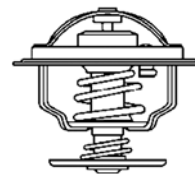

# NISSAN

	Engine	Ltr.	Year	Restriction*	Thermostat
<b>VANETTE (C22)</b>					
1.2		1.2	1982.07 - 1984.10		<b>3118.82D1</b>
1.5	A15S	1.5	1981.07 - 1995.12		<b>3118.82D1</b>
1.5	A15	1.5	1982.07 - 1987.06		<b>3118.82D1</b>
<b>VANETTE (HC 23)</b>					
1.6 i	GA16DE	1.6	1995.01 -		<b>3478.82D</b>
<b>VERSA</b>					
1.6 Flex	HR16DE	1.6	2011.01 -		<b>411241.82D</b>
<b>X-TRAIL (T31)</b>					
2.0	MR20DE	2.0	2007.03 -		<b>411241.82D</b>
2.0 dCi	M9R 760	2.0	2007.06 -		<b>411475.89D ▲</b>

# OPEL

	Engine	Ltr.	Year	Restriction*	Thermostat
<b>AGILA (A)</b>					
1.0	Z 10 XEP	1.0	2003.08 - 2007.12		411579.92D ▲
1.0 12V	Z 10 XE	1.0	2000.09 - 2007.12		411579.92D ▲
1.2 16V	Z 12 XE	1.2	2000.09 - 2007.12		411579.92D ▲
1.2 16V Twinport	Z 12 XEP	1.2	2004.07 - 2007.12		411579.92D ▲
1.3 CDTI	Z 13 DT	1.3	2003.08 - 2007.12		410588.88D
<b>AGILA (B)</b>					
1.3 CDTI	D13A, Z 13 DTJ	1.3	2008.04 -		410588.88D
<b>ANTARA</b>					
2.4	Z 24 XE, Z 24 XED	2.4	2006.05 -		4189.87D
2.4	A 24 XE	2.4	2010.12 -		411193.82D
<b>ARENA</b>					
1.9 D	F8Q 606	1.9	1998.03 - 2001.08	Chassis No. →C 004093	3470.89D50
1.9 D	F8Q 600	1.9	1998.03 - 2001.08	Chassis No. →C 019063	410530.89D
1.9 D	F8Q 600	1.9	1998.04 - 2001.08	Chassis No. C 019064→	3470.89D50
1.9 D	F8Q 606	1.9	1998.04 - 2001.08	Chassis No. 004094→, →C 015185	410530.89D
1.9 D	F8Q 606	1.9	1998.05 - 2001.08	Chassis No. C 015186→	3470.89D50
2.5 D	S8U 780, S8U 782, S8U 758	2.5	1998.03 - 2001.08		4151.76D
<b>ASCONA C</b>					
1.3 N	13 N	1.3	1981.09 - 1986.08		3017.92D2
1.3 S	13 S	1.3	1981.09 - 1988.08		3017.92D2
1.6	16 N	1.6	1981.09 - 1988.08		4164.92D
1.6	16 SV	1.6	1986.09 - 1988.08		3017.92D2
1.6 D	16 DA, 16 D	1.6	1982.03 - 1988.08		4115.92D
1.6 i	C 16 NZ, C 16 LZ	1.6	1986.09 - 1988.08		3017.92D2
1.6 i	E 16 NZ, E 16 LZ	1.6	1987.09 - 1988.08		3017.92D2
1.6 S	16 SH	1.6	1981.09 - 1986.08		4164.92D
1.8	E 18 NV	1.8	1987.09 - 1988.08		4164.92D
1.8 E	S 18 NV, C 18 NE	1.8	1985.01 - 1986.08		4115.92D
1.8 i	18 E	1.8	1982.09 - 1986.08		4115.92D
2.0 i	20 NE, 20 SEH	2.0	1986.09 - 1988.08		4144.92D
2.0 i	C 20 NE, C 20 NEF	2.0	1986.09 - 1988.08		4144.92D
<b>ASTRA F</b>					
1.4	14 NV, 14 SE	1.4	1991.09 - 1998.09		3017.92D2
1.4 i	C 14 NZ, X 14 NZ	1.4	1991.09 - 1999.01		3017.92D2
1.4 i 16V	X 14 XE	1.4	1996.01 - 2001.03		4178.92D
1.4 Si	C 14 SE	1.4	1992.03 - 2001.03		3017.92D2
1.6	16 NZR	1.6	1995.09 - 1998.09		3017.92D2
1.6	16 LZ2	1.6	1995.09 - 1998.09	ohne Klimaanlage	4168.92D
1.6 i	C 16 NZ, X 16 SZR	1.6	1991.09 - 1998.09		3017.92D2
1.6 i	X 16 SZ, X 16 SZR	1.6	1993.02 - 1996.08		3017.92D2
1.6 i 16V	X 16 XEL	1.6	1994.08 - 1998.09		4178.92D
1.6 Si	C 16 SE	1.6	1992.03 - 1994.12		3017.92D2
1.7 D	17D, 17 DR	1.7	1991.12 - 1999.01		4115.92D

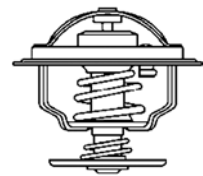

# OPEL

	Engine	Ltr.	Year	Restriction*	Thermostat
1.7 TD	X 17 DTL	1.7	1994.08 - 1999.01		<b>4115.92D</b>
1.7 TDS	17 DT (TC4EE1), X 17 DT (TC4EE1)	1.7	1991.11 - 1998.09	Motor no. →731418	<b>3468.88D</b>
1.7 TDS	17 DT (TC4EE1), X 17 DT (TC4EE1)	1.7	1991.12 - 1998.09	Motor no. 731419→	<b>3467.85D</b>
1.8	18 SE	1.8	1991.11 - 1993.07	ohne Gehäuse	<b>4115.92D</b>
1.8	18 SE	1.8	1991.11 - 1993.07	mit Gehäuse	<b>4164.92D</b>
1.8 i	C 18 NZ	1.8	1991.09 - 1998.09		<b>4168.92D</b>
1.8 i 16V	C 18 XE, C 18 XEL, X 18 XE	1.8	1993.06 - 2001.03	Chassis No. →01458051	<b>4177.92D</b>
1.8 i 16V	C 18 XE, C 18 XEL, X 18 XE	1.8	1993.07 - 2001.03	Chassis No. 01458052→	<b>4183.92D</b>
2.0 GSI 16V	C 20 XE	2.0	1991.09 - 1998.01		<b>4164.92D</b>
2.0 i	C 20 NE	2.0	1991.09 - 1998.09		<b>4168.92D</b>
2.0 i 16V	C 20 XE	2.0	1993.03 - 1998.01		<b>4164.92D</b>
2.0 i 16V	X 20 XEV	2.0	1995.02 - 1998.09		<b>4183.92D</b>
<b>ASTRA F Classic</b>					
1.2 i	X 12 XE	1.2	1998.03 - 2000.08		<b>4459.92D</b>
1.4	Z 14 XEP	1.4	2003.09 - 2005.01		<b>4459.92D</b>
1.4 i	X 14 NZ	1.4	1998.01 - 2005.01		<b>3017.92D2</b>
1.4 i	X 14 XE	1.4	1998.03 - 2000.08		<b>4242.92D</b>
1.6 i	X 16 SZR	1.6	1998.01 - 2005.01		<b>3017.92D2</b>
1.6 i 16V	X 16 XEL	1.6	1998.01 - 2005.01		<b>4208.92D</b>
2.0 Di	X 20 DTL	2.0	1998.03 - 2000.08		<b>4198.92D</b>
2.0 i	X 20 XER, X 20 XEV	2.0	1998.03 - 2000.08		<b>4183.92D</b>
<b>ASTRA G</b>					
1.2 16V	X 12 XE, Z 12 XE	1.2	1998.02 - 2005.01		<b>4459.92D</b>
1.4	Z 14 XEP	1.4	2007.09 - 2009.12		<b>4459.92D</b>
1.4 16V	X 14 XE	1.4	1998.02 - 2005.01		<b>4208.92D</b>
1.4 16V	Z 14 XE	1.4	1998.02 - 2005.01		<b>4242.92D</b>
1.6	X 16 SZR, Z 16 SE	1.6	1998.02 - 2005.01		<b>3017.92D2</b>
1.6	Z 16 YNG	1.6	2002.06 - 2004.03		<b>4242.92D</b>
1.6	Z 16 XEP	1.6	2002.12 - 2009.12		<b>4431.105D</b>
1.6 16V	C 16 SEL, X 16 XEL	1.6	1998.02 - 2005.01		<b>4208.92D</b>
1.6 16V	Z 16 XE	1.6	1998.02 - 2005.01		<b>4242.92D</b>
1.6 16V	Z 16 XEP	1.6	2000.03 - 2005.05		<b>4431.105D</b>
1.6 CNG	Z 16 YNG	1.6	2003.03 - 2004.07		<b>4242.92D</b>
1.7 TD	X 17 DTL	1.7	1998.02 - 2005.04		<b>4115.92D</b>
1.8	Z 18 XEL	1.8	2003.02 - 2004.01		<b>411578.92D ▲</b>
1.8 16V	Z 18 XE, X 18 XE1	1.8	1998.02 - 2005.10		<b>411578.92D ▲</b>
2.0 16V	C 20 SEL, X 20 XEV	2.0	1998.02 - 2005.01		<b>4183.92D</b>
2.0 16V OPC	X 20 XER	2.0	1999.11 - 2002.09		<b>4183.92D</b>
2.0 16V Turbo	Z 20 LET	2.0	2000.09 - 2005.10		<b>4183.92D</b>
2.0 DI	X 20 DTL, Y 20 DTL	2.0	1998.02 - 2005.04		<b>4198.92D</b>
2.0 DTI 16V	Y 20 DTH	2.0	1999.08 - 2005.01	Motor no. →17B49754	<b>4198.92D</b>
2.0 DTI 16V	Y 20 DTH	2.0	1999.09 - 2005.01	Motor no. 17B49755→, 2(2/5/6/8/B/H)999999	<b>4428.92D</b>
2.0 DTI 16V	Y 20 DTH	2.0	1999.10 - 2005.01	Motor no. 2(2/5/6/8/B/H) 999999→	<b>4433.92D</b>
2.0 OPC	Z 20 LET	2.0	2002.03 - 2005.10		<b>4183.92D</b>
2.2 16V	Z 22 SE	2.2	2000.09 - 2005.10		<b>411193.82D</b>
2.2 DTI	Y 22 DTR	2.2	2002.09 - 2005.10		<b>4433.92D</b>



# Thermostats

## OPEL

	Engine	Ltr.	Year	Restriction*	Thermostat
<b>ASTRA H</b>					
1.2	Z 12 XEP	1.2	2005.08 -		4459.92D
1.3 CDTI	Z 13 DTH	1.3	2005.08 -		410048.88D
1.4	Z 14 XEL, Z 14 XEP	1.4	2004.04 -		4459.92D
1.4 LPG	Z 14 XEP	1.4	2009.08 -		4459.92D
1.6	A 16 XER, Z 16 XE1, Z 16 XEP, Z 16 XER	1.6	2004.03 -		4431.105D
1.6 Turbo	Z 16 LET	1.6	2007.02 -		4357.92D
1.8	Z 18 XE	1.8	2004.03 -		411578.92D ▲
1.8	A 18 XER, Z 18 XER	1.8	2005.08 -		4431.105D
1.9 CDTI	Z 19 DT, Z 19 DTH, Z 19 DTL	1.9	2004.06 -		410049.88D
1.9 CDTI 16V	Z 19 DTJ	1.9	2004.04 -		410049.88D
2.0 Turbo	Z 20 LEH, Z 20 LEL, Z 20 LER	2.0	2004.03 -		4183.92D
<b>ASTRA J</b>					
1.3 CDTI	A 13 DTE	1.3	2009.12 -		411774.88D ▲
1.6	A 16 XER	1.6	2009.12 -		411059.105D ▲
1.6 Turbo	A 16 LET	1.6	2009.12 -		411059.105D ▲
<b>ASTRA GTC J</b>					
1.6	A 16 LET	1.6	2011.10 -		411059.105D ▲
1.8	A 18 XER	1.8	2011.10 -		411059.105D ▲
<b>CALIBRA A</b>					
2.0 i	C 20 NE	2.0	1990.06 - 1997.07		4144.92D
2.0 i 16V	C 20 XE	2.0	1990.06 - 1994.02		4164.92D
2.0 i 16V	X 20 XEV	2.0	1994.02 - 1997.07		4183.92D
2.0 i Turbo	C 20 LET	2.0	1992.03 - 1997.07		4164.92D
2.5 i V6	X 25 XE, C 25 XE	2.5	1993.04 - 1997.07		4175.92D
<b>COMBO</b>					
1.2	C 12 NZ, X 12 SZ	1.2	1994.07 - 2001.10		3017.92D2
1.3 CDTI 16V	Y 13 DT, Z 13 DT, Z 13 DTJ	1.3	2004.10 -		410588.88D
1.4	C 14 NZ, C 14 SE, X 14 SZ	1.4	1994.07 - 2001.10		3017.92D2
1.4	Z 14 XEP	1.4	2004.10 -		4459.92D
1.4 16V	X 14 XE	1.4	1999.08 - 2001.10		4178.92D
1.4 16V	Z 14 XEP	1.4	2005.08 -		4459.92D
1.6	Z 16 SE	1.6	2001.10 -		3017.92D2
1.6 CNG	Z 16 YNG	1.6	2005.04 -		4242.92D
1.6 CNG 16V	Z 16 YNG	1.6	2005.04 -		4242.92D
1.7 D	17 D (4EE1), X 17 D (4EE1)	1.7	1994.07 - 2001.10	Motor no. →334922	3467.85D
<b>COMBO (X12)</b>					
1.3 CDTI	A 13 FD	1.3	2012.02 -		411774.88D ▲
<b>CORSA A</b>					
1.0	10 S	1.0	1982.09 - 1993.03		3017.92D2
1.2	12 S, 12 ST, E 12 GV, 12 NC	1.2	1982.09 - 1990.08		3017.92D2
1.2 i	C 12 NZ	1.2	1989.09 - 1993.03		3017.92D2
1.2 N	E 12 GV, 12 NC, 12 NV	1.2	1985.01 - 1993.03		3017.92D2
1.2 S	12 S, 12 ST	1.2	1982.09 - 1993.03		3017.92D2
1.3	13 S, 13 SB	1.3	1982.09 - 1993.03		3017.92D2
1.3	13 NB, C 13 N	1.3	1985.09 - 1989.10		3017.92D2
1.3 i	C 13 N	1.3	1986.09 - 1990.09		3017.92D2

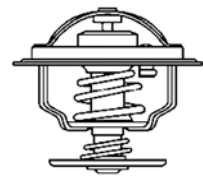

# OPEL

	Engine	Ltr.	Year	Restriction*	Thermostat
1.3 S	13 SB	1.3	1982.09 - 1989.10		3017.92D2
1.4 i	C 14 NZ	1.4	1985.01 - 1993.03		3017.92D2
1.4 S	14 NV	1.4	1989.09 - 1993.03		3017.92D2
1.4 Si	C 14 SE	1.4	1991.09 - 1993.03		3017.92D2
1.5 D	15 D (4EC1)	1.5	1987.06 - 1993.03		3468.88D
1.5 TD	15 DT (T4EC1)	1.5	1987.10 - 1993.03		3468.88D
1.6 GSI	C 16 NZ, C 16 SE, C 16 SEI, E 16 SE	1.6	1988.05 - 1993.03		3017.92D2

## CORSA B

1.0 i 12V	X 10 XE	1.0	1996.11 - 2000.09		4459.92D
1.2 i	12 NZ, C 12 NZ, X 12 SZ	1.2	1993.03 - 2000.09		3017.92D2
1.2 i 16V	X 12 XE	1.2	1998.03 - 2000.09		4459.92D
1.3	13 NB	1.3	1996.01 - 2002.12		3017.92D2
1.4	C 14 SE	1.4	1993.04 - 1994.08		3017.92D2
1.4 i	C 14 NZ, X 14 SZ	1.4	1993.03 - 2000.09		3017.92D2
1.4 i 16V	C 14 SEL X 14 XE	1.4	1994.09 - 2000.09		4178.92D
1.4 Si	C 14 SE	1.4	1993.03 - 2000.09		3017.92D2
1.5 D	15 D (4EC1)	1.5	1993.03 - 2000.09	Motor no. →544012	3468.88D
1.5 D	15 D (4EC1)	1.5	1993.04 - 2000.09	Motor no. 544013 →	3467.85D
1.5 TD	X 15 DT (T4EC1), 15 DT (T4EC1)	1.5	1993.03 - 2000.09	Motor no. →544012	3468.88D
1.5 TD	X 15 DT (T4EC1), 15 DT (T4EC1)	1.5	1993.04 - 2000.09	Motor no. 544013 →	3467.85D
1.6 GSI 16V	C 16 XE	1.6	1993.03 - 2000.09		4178.92D
1.6 i 16V	C 16 SEL, X 16 XE	1.6	1994.09 - 2000.09		4178.92D
1.7 D	17 D (4EE1), X 17 D (4EE1)	1.7	1996.02 - 2000.09	Motor no. →334922	3467.85D

## CORSA C

1.0	Z 10 XE, Z 10 XEP	1.0	2000.09 - 2009.12		4459.92D
1.2	Z 12 XE, Z 12 XEP	1.2	2000.09 - 2009.12		4459.92D
1.2 16V	Z 12 XE	1.2	2000.09 -		4459.92D
1.2 Twinport	Z 12 XEP	1.2	2004.07 - 2009.12		4459.92D
1.3 CDTI	Z 13 DT	1.3	2003.06 - 2009.12		410588.88D
1.3 CDTI 16V	Z 13 DT	1.3	2005.08 -		410588.88D
1.4	Z 14 XE Z 14 XEP	1.4	2000.09 - 2009.12		4242.92D
1.4 Twinport	Z 14 XEP	1.4	2003.06 - 2009.12		4459.92D
1.6	Z 16 YNG	1.6	2005.08 - 2006.07		4242.92D
1.8	Z 18 XE	1.8	2000.09 - 2009.12		411578.92D ▲

## CORSA D

1.0	A 10 XEP, Z 10 XEP	1.0	2006.07 -		4459.92D
1.2	Z 12 XEP	1.2	2006.07 -		4459.92D
1.2 LPG	Z 12 XEP	1.2	2009.09 -		4459.92D
1.3 CDTI	13 DTJ	1.3	2006.07 -		410048.88D
1.3 CDTI	A 13 DTC	1.3	2006.07 -		411774.88D ▲
1.3 CDTI	A 13 DTR, Z 13 DTE	1.3	2010.06 -		411774.88D ▲
1.4	Z 14 XEP	1.4	2006.07 -		4459.92D
1.4 LPG	Z 14 XEP	1.4	2006.07 -		4459.92D
1.6 Turbo	A 16 LEL, A 16 LER, A 16 LES, Z 16 LEL, Z 16 LER	1.6	2007.02 -		4357.92D

## FRONTERA A

2.0 i	C 20 NE, X 20 SE	2.0	1992.03 - 1998.10		4144.92D
2.2 i	X 22 XE	2.2	1995.03 - 1998.10		4177.92D
2.3 TD	23 DTR	2.3	1992.03 - 1998.10		4255.92D
2.4 i	C 24 NE	2.4	1992.03 - 1998.10		4255.92D
2.5 TDS	25TDS (VM41B)	2.5	1996.09 - 1998.10		4158.80D

# OPEL

	Engine	Ltr.	Year	Restriction*	Thermostat
<b>FRONTERA B</b>					
2.2 DTI	X 22 DTH, Y 22 DTH	2.2	1998.10 - 2002.09		<b>4207.92D</b>
2.2 i	X 22 SE, Y 22 SE	2.2	1998.10 -		<b>4194.92D</b>
<b>GT</b>					
2.0	LNF, Z 20 NHH	2.0	2007.06 -		<b>411193.82D</b>
<b>INSIGNIA</b>					
1.6	A 16 XER	1.6	2008.07 -	Chassis No. →91999999	<b>4431.105D</b>
1.6	A 16 XER	1.6	2008.08 -	Chassis No. A1000001→	<b>411059.105D ▲</b>
1.6 Turbo	A 16 LET	1.6	2008.07 -		<b>4357.92D</b>
1.8	A 18 XER	1.8	2008.07 -	Chassis No. →91999999	<b>4431.105D</b>
1.8	A 18 XER	1.8	2008.08 -	Chassis No. A1000001→	<b>411059.105D ▲</b>
2.0 Turbo	A 20 NFT	2.0	2011.09 -		<b>411193.82D</b>
<b>KADETT E</b>					
1.2	12 SC	1.2	1984.09 - 1986.07		<b>3017.92D2</b>
1.3 i	C 13 N	1.3	1985.09 - 1991.08		<b>3017.92D2</b>
1.3 N	13 N	1.3	1984.09 - 1991.08		<b>3017.92D2</b>
1.3 S	13 S	1.3	1984.09 - 1993.02		<b>3017.92D2</b>
1.4 i	C 14 NZ	1.4	1990.01 - 1994.07		<b>3017.92D2</b>
1.4 S	14 NV, C 14 SE	1.4	1989.07 - 1991.08		<b>3017.92D2</b>
1.5 TD	15 DT (T4EC1)	1.5	1988.07 - 1991.08		<b>3468.88D</b>
1.6	16 SV, E 16 SE	1.6	1986.09 - 1991.12		<b>3017.92D2</b>
1.6 D	16 D, 16 DA	1.6	1984.08 - 1989.12		<b>4115.92D</b>
1.6 i	16 SV, C 16 LZ, C 16 NZ, E 16 NZ	1.6	1989.07 - 1994.07		<b>3017.92D2</b>
1.6 S	16 SH	1.6	1984.09 - 1986.08		<b>4115.92D</b>
1.6 S	16 SV	1.6	1986.09 - 1991.08		<b>3017.92D2</b>
1.7 D	17 D, 17 DR	1.7	1988.08 - 1994.07		<b>4115.92D</b>
1.8	18 SE	1.8	1986.01 - 1990.08		<b>4164.92D</b>
1.8	18 E	1.8	1987.09 - 1990.08		<b>4115.92D</b>
1.8 E	C 18 NE	1.8	1985.10 - 1986.08		<b>4115.92D</b>
1.8 GSI	18 E	1.8	1984.09 - 1986.08		<b>4115.92D</b>
1.8 i	C 18 NT	1.8	1984.08 - 1992.09		<b>4115.92D</b>
1.8 i	18 E	1.8	1984.09 - 1986.08		<b>4164.92D</b>
1.8 i	18 SV, C 18 NZ	1.8	1985.06 - 1991.08		<b>4144.92D</b>
1.8 S	E 18 NV, S 18 NV	1.8	1987.09 - 1991.08		<b>4164.92D</b>
2.0 GSI	20 NE, 20 SEH, C 20 NE	2.0	1986.09 - 1991.08		<b>4164.92D</b>
2.0 GSI 16V	20 XE, 20 XEJ, C 20 XE	2.0	1987.12 - 1991.08		<b>4164.92D</b>
2.0 i	20 NE, 20 SE, C 20 NE	2.0	1986.10 - 1993.02		<b>4164.92D</b>
<b>MANTA B</b>					
1.2 N	12 N	1.2	1976.08 - 1983.07		<b>3017.87D50</b>
1.2 S	12 S	1.2	1975.09 - 1979.02		<b>3017.87D50</b>
1.3 N	13 N	1.3	1979.03 - 1980.12		<b>3017.92D50</b>
1.3 S	13 S	1.3	1979.08 - 1986.08		<b>3017.92D50</b>
1.6 N	16 N	1.6	1975.09 - 1980.12	Motor no. →16N-622327	<b>3054.92D50</b>
1.6 N	16 N	1.6	1975.10 - 1980.12	Motor no. 16N-622328→	<b>3017.92D2</b>
1.6 S	16 S	1.6	1975.09 - 1981.12	Motor no. →16S-687305	<b>3054.92D50</b>

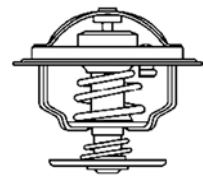

# OPEL

	Engine	Ltr.	Year	Restriction*	Thermostat
1.6 S	16 S	1.6	1975.10 - 1981.12	Motor no. 16S-687306→	<b>3017.92D2</b>
1.8 S	18 S	1.8	1982.07 - 1987.08		<b>4115.92D</b>
1.9 E	19 E	1.9	1975.09 - 1977.08		<b>4255.82D</b>
1.9 N	19 N	1.9	1976.08 - 1981.12	Motor no. →19N-517783	<b>3054.92D50</b>
1.9 N	19 N	1.9	1976.09 - 1981.12	Motor no. 19N-517784→	<b>3017.92D2</b>
1.9 S	19 S	1.9	1975.09 - 1980.12		<b>3054.87D50</b>
2.0	20 N	2.0	1977.08 - 1980.12	Motor no. →20N-190247	<b>3054.92D50</b>
2.0	20 N	2.0	1977.09 - 1980.12	Motor no. 20N-190248→	<b>3017.92D2</b>
2.0 E	20 E	2.0	1977.08 - 1988.08		<b>4255.87D</b>
2.0 S	20 S	2.0	1977.08 - 1984.08	Motor no. →20S-602835	<b>3054.92D50</b>
2.0 S	20 S	2.0	1977.09 - 1984.08	Motor no. 0S-602836→	<b>3017.92D2</b>
<b>MERIVA</b>					
1.3 CDTI	Y 13 DT, Z 13 DT, Z 13 DTJ	1.3	2003.09 - 2010.05		<b>410588.88D</b>
1.4 16V Twinport	Z 14 XEP	1.4	2004.07 - 2010.05		<b>4459.92D</b>
1.4 16V Twinport LPG	Z 14 XEP	1.4	2004.07 - 2010.05		<b>4459.92D</b>
1.6	Z 16 SE	1.6	2003.05 - 2010.05		<b>3017.92D2</b>
1.6	Z 16 XEP	1.6	2006.01 - 2010.05		<b>4431.105D</b>
1.6 16V	Z 16 XE	1.6	2003.05 - 2006.01		<b>4242.92D</b>
1.6 Turbo	Z 16 LET	1.6	2005.09 - 2010.05		<b>4357.92D</b>
1.8	Z 18 XE	1.8	2003.05 - 2010.05		<b>411578.92D ▲</b>
<b>MERIVA B</b>					
1.3 CDTI	A 13 DTC, A 13 DTE	1.3	2010.06 -		<b>411774.88D ▲</b>
<b>MOKKA</b>					
1.6	A 16 XER	1.6	2012.06 -		<b>411059.105D ▲</b>
<b>MONZA A</b>					
2.0 E	H 20 E	2.0	1983.03 - 1984.10		<b>4255.87D</b>
2.2 E	22 E	2.2	1984.11 - 1986.08		<b>4255.92D</b>
2.5 E	25 E, H 25 E	2.5	1981.05 - 1986.08		<b>4255.92D</b>
2.8	28 H	2.8	1978.02 - 1981.04		<b>3054.92D50</b>
3.0	30 H	3.0	1978.04 - 1982.07		<b>4255.92D</b>
3.0 GSE	30 E, C 30 LE	3.0	1978.02 - 1986.08		<b>4255.92D</b>
<b>MOVANO</b>					
1.9 DTI	F9Q 770	1.9	2000.09 - 2001.10	Chassis No. C000140→	<b>3470.89D50</b>
1.9 DTI	F9Q 772, F9Q 774	1.9	2001.10 -		<b>410517.83D</b>
2.5 D	S8U 772, S8U 770	2.5	1998.07 - 2000.09		<b>4174.79D</b>
2.8 DTI	S9W 702, S9W 700	2.8	1998.07 - 2001.10		<b>4174.79D</b>
<b>OMEGA A</b>					
1.8	18 SEH, E 18 NVR	1.8	1986.09 - 1994.03		<b>4144.92D</b>
1.8 N	18 NV	1.8	1986.09 - 1987.08		<b>4144.92D</b>
1.8 S	18 SV	1.8	1986.09 - 1994.03		<b>4144.92D</b>
2.0	20 SE, C 20 NEF, C 20 NEJ	2.0	1986.09 - 1994.03		<b>4144.92D</b>
2.0 i	C 20 NE, C 20 NEJ	2.0	1986.09 - 1994.03		<b>4144.92D</b>

# Thermostats

## OPEL

	Engine	Ltr.	Year	Restriction*	Thermostat
2.3 D	23 YD	2.3	1986.09 - 1994.03		4255.92D
2.3 TD	23 YDT	2.3	1986.09 - 1988.08		4255.92D
2.3 TD Interc.	23 DTR	2.3	1988.08 - 1994.03		4255.92D
2.4 i	C 24 NE	2.4	1988.09 - 1994.03		4255.92D
2.6 i	C 26 NE	2.6	1990.09 - 1994.03		4255.92D
3.0	30 NE, C 30 NE	3.0	1987.03 - 1994.03		4255.92D
3.0 (3000)	30 NE, C 30 LE, C 30 NE	3.0	1987.03 - 1994.03		4255.92D
3.0 24V	C 30 SEJ	3.0	1989.09 - 1994.03		4255.92D
3.0 24V (3000)	C 30 SE, C 30 SEJ	3.0	1989.09 - 1994.03		4255.92D

## OMEGA B

2.0	X 20 SE	2.0	1994.03 - 1999.09		4144.92D
2.0 16V	X 20 XEV	2.0	1994.03 - 1999.09		4183.92D
2.0 DTI 16V	X 20 DTH	2.0	1997.09 - 2000.09		4188.92D
2.2 16V	Y 22 XE, Z 22 XE	2.2	1999.09 - 2003.07		4183.92D
2.2 DTI 16V	Y 22 DTH	2.2	2000.09 - 2003.07		4188.92D
2.5 TD	25 DT, X 25 TD, X 25 DT	2.5	1994.04 - 2003.07		4237.80D
2.5 V6	X 25 XE	2.5	1994.03 - 2000.09		4175.92D
2.6 V6	Y 26 SE	2.6	2000.09 - 2003.07	Motor no. → 11 999 999, Hersteller WAHLER	4175.92D
3.0 V6	X 30 XE	3.0	1994.04 - 2001.02		4175.92D
3.2 V6	Y 32 SE	3.2	2001.02 - 2003.07	Motor no. → 11 999 999, Hersteller WAHLER	4175.92D

## REKORD E

1.7	17 N	1.7	1977.09 - 1982.10	Motor no. → 17N-440978	3054.87D50
1.7	17 N	1.7	1977.10 - 1982.10	Motor no. 17N-440979→	3021.88D50
1.8	18 N	1.8	1982.11 - 1986.08		4115.92D
1.8 E	C 18 NV	1.8	1985.05 - 1986.08		4115.92D
1.8 S	18 S	1.8	1982.11 - 1986.08		4115.92D
1.9	19 N	1.9	1977.09 - 1982.10	Motor no. → 19N-517783	3054.87D50
1.9	19 N	1.9	1977.10 - 1982.10	Motor no. 19N-517784→	3021.88D50
2.0	20 N	2.0	1977.09 - 1982.10	Motor no. → 20N-190247	3054.87D50
2.0	20 N	2.0	1977.10 - 1982.10	Motor no. 20N-190248→	3021.88D50
2.0 D	20 D	2.0	1977.09 - 1982.10		4255.92D
2.0 E	20 E	2.0	1977.09 - 1984.10		4255.87D
2.0 S	20 S	2.0	1977.08 - 1986.08	Motor no. → 20S-602835	3054.87D50
2.0 S	20 S	2.0	1977.09 - 1986.08	Motor no. 20S-602836→	3021.88D50
2.1 D	21 D	2.1	1977.09 - 1978.07		4255.92D
2.2 D	23 D	2.2	1978.08 - 1986.08		4255.92D
2.2 E	22 E	2.2	1984.11 - 1986.08		4255.92D
2.2 TD	23 TD	2.2	1984.06 - 1986.08		4255.92D
2.3 D	23 D	2.3	1982.11 - 1986.08		4255.92D

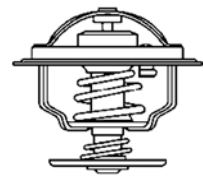

# OPEL

	Engine	Ltr.	Year	Restriction*	Thermostat
<b>SENATOR</b>					
2.0 E	H 20 E	2.0	1983.03 - 1984.10		4255.87D
2.2 E	22 E	2.2	1984.11 - 1987.08		4255.87D
2.2 TD	23 TD	2.2	1984.11 - 1987.08		4255.92D
2.5	25 S	2.5	1978.05 - 1980.12		3054.92D50
2.5 E	25 E, H 25 E	2.5	1983.01 - 1987.08		4255.87D
2.5 i	25 NE	2.5	1990.09 - 1993.09		4255.92D
2.6 i	C 26 NE	2.6	1990.09 - 1993.09		4255.92D
2.8	28 H	2.8	1978.02 - 1981.04		3054.92D50
3.0	30 H, 30 NE, C 30 LE	3.0	1978.04 - 1993.09		4255.92D
3.0 24V	C 30 SE	3.0	1989.09 - 1993.09		4255.92D
3.0 E	30 E	3.0	1978.02 - 1986.12		4255.92D
3.0 i	C 30 NE	3.0	1988.01 - 1993.09		4255.92D
<b>SIGNUM</b>					
1.8	Z 18 XER	1.8	2005.09 -		4431.105D
1.9 CDTI	Z 19 DT, Z 19 DTH	1.9	2004.04 -		410049.88D
2.0 DTI	Y 20 DTH	2.0	2003.05 -		4297.92D
2.0 Turbo	Z 20 NET	2.0	2003.05 -		411193.82D
2.2 direct	Z 22 YH	2.2	2003.05 -		411193.82D
2.2 DTI	Y 22 DTR	2.2	2003.05 -		4297.92D
<b>SINTRA</b>					
2.2 i 16V	X 22 XE	2.2	1996.11 - 1999.04		4183.92D
3.0 i 24V	X 30 XE	3.0	1996.11 - 1999.04		4175.92D
<b>SPEEDSTER</b>					
2.0	Z 20 LET	2.0	2003.10 - 2006.08		4183.92D
2.0 Turbo	Z 20 LET	2.0	2003.04 -		4183.92D
2.2	Z 22 SE	2.2	2000.09 -		411193.82D
<b>TIGRA</b>					
1.4 16V	X 14 XE	1.4	1994.07 - 2000.12		4178.92D
1.6 16V	C 16 SEL, X 16 XE	1.6	1994.07 - 1998.08		4178.92D
<b>TIGRA TwinTop</b>					
1.3 CDTI	Z 13 DT	1.3	2004.06 -		410588.88D
1.4	Z 14 XEP	1.4	2004.06 -		4459.92D
1.8	Z 18 XE	1.8	2004.06 -		411578.92D ▲
<b>VECTRA A</b>					
1.4 S	14 NV	1.4	1988.04 - 1992.06		3017.92D2
1.6	16 SV, C 16 LZ2, E 16 NZ	1.6	1988.08 - 1994.06		3017.92D2
1.6 i	C 16 NZ, E 16 NZ, X 16 SZ	1.6	1988.09 - 1995.11		3017.92D2
1.6 i	C 16 NZ2	1.6	1988.09 - 1995.11		4144.82D
1.6 i	16 LZ2	1.6	1993.09 - 1995.11	ohne Klimaanlage	4168.92D
1.6 i	16 LZ2	1.6	1993.09 - 1995.11	ohne Klimaanlage	4168.92D
1.6 S	16 SV	1.6	1988.09 - 1993.05		3017.92D2
1.7 D	17 D, 17 DR	1.7	1988.09 - 1995.11		4115.92D
1.7 TD	17 DT (TC4EE1), X 17 DT (TC4EE1)	1.7	1990.03 - 1995.11	Motor no. →731418	3468.88D
1.7 TD	17 DT (TC4EE1), X 17 DT (TC4EE1)	1.7	1990.04 - 1995.11	Motor no. 731419 →	3467.85D
1.8 i	18 SV, C 18 NZ	1.8	1988.09 - 1995.11		4144.92D
1.8 S	18 SV, E 18 NVR	1.8	1988.09 - 1990.10		4144.92D

# Thermostats

## OPEL

	Engine	Ltr.	Year	Restriction*	Thermostat
2.0	C 20 NEF	2.0	1988.04 - 1989.09		4144.92D
2.0	C 20 XE	2.0	1989.08 - 1995.08		4164.92D
2.0 i	20 NE, 20 SEH, C 20 NE	2.0	1988.09 - 1995.11		4144.92D
2.0 i 16V	20 XEJ, C 20 XE, X 20 XEV	2.0	1989.02 - 1995.11		4164.92D
2.0 i 16V	X 20 XEV	2.0	1994.06 - 1995.11		4183.92D
2.0 i GT	20 SEH	2.0	1988.09 - 1995.11		4144.92D
2.0 i Turbo	C 20 LET	2.0	1994.06 - 1995.11		4164.92D
2.5 CD	C 25 XE	2.5	1992.08 - 1995.08		4175.92D
2.5 V6	C 25 XE	2.5	1993.02 - 1995.11		4175.92D
2000 16V	20 XEJ	2.0	1989.01 - 1990.10		4164.92D
2000/GT 16V	20 XEJ, C 20 XE	2.0	1989.01 - 1995.11		4164.92D

## VECTRA B

1.6 GL	16 SV	1.6	1995.09 - 1996.08		3017.92D2
1.6 i	X 16 SZR	1.6	1995.10 - 2003.07		3017.92D2
1.6 i	16 LZ2	1.6	1995.10 - 2003.07		4144.82D
1.6 i 16V	X 16 XEL	1.6	1995.10 - 2002.07		4178.92D
1.6 i 16V	Z 16 XE, Y 16 XE	1.6	1995.10 - 2002.07		4242.92D
1.7 TD	X 17 DT (TC4EE1)	1.7	1995.10 - 1998.12		3467.85D
1.8 i 16V	Z 18 XE, Z 18 XEL, X 18 XE1	1.8	1995.10 - 2003.07		411578.92D ▲
1.8 i 16V	X 18 XE	1.8	1995.10 - 2000.09		4183.92D
2.0 DI 16V	X 20 DTL	2.0	1996.11 - 2002.04		4188.92D
2.0 DTI 16V	Y 20 DTH, X 20 DTH	2.0	1997.06 - 2003.07		4201.92D
2.0 i 16V	X 20 XEV, C 20 SEL	2.0	1995.10 - 2000.09		4183.92D
2.2 DTI 16V	Y 22 DTR	2.2	2000.09 - 2003.07		4201.92D
2.2 i 16V	Z 22 SE	2.2	2000.09 - 2003.07		411193.82D
2.5 i V6	X 25 XE	2.5	1995.10 - 2000.09		4175.92D
2.6 i V6	Y 26 SE	2.6	2000.09 - 2003.07	Motor no. →11162841 / →17080724, Hersteller WAHLER	4175.92D
2.6 i V6	Y 26 SE	2.6	2000.09 - 2003.07		4175.92D
i 500 2.5	X 25 XE	2.5	1998.05 - 2000.09		4175.92D

## VECTRA C

1.6	Z 16 XE	1.6	2005.08 -		4242.92D
1.6	Z 16 XEP	1.6	2006.01 -		4431.105D
1.6 16V	Z 16 XE	1.6	2004.06 -		4242.92D
1.8	Z 18 XE, Z 18 XEL	1.8	2002.04 -		411578.92D ▲
1.8	Z 18 XER	1.8	2006.01 -		4431.105D
1.8 16V	Z 18 XE, Z 18 XEL	1.8	2002.04 -		411578.92D ▲
1.9 CDTI	Z 19 DT, Z 19 DTH	1.9	2004.04 -		410049.88D
1.9 CDTI	Z 19 DTL	1.9	2005.10 -		410049.88D
2.0 16V Turbo	Z 20 NET	2.0	2003.03 -		411193.82D
2.0 DTI	Y 20 DTH	2.0	2003.10 -		4297.92D
2.0 DTI 16V	Y 20 DTH	2.0	2002.04 -		4297.92D
2.0 Turbo	Z 20 NET	2.0	2003.10 -		411193.82D
2.2 16V	Z 22 SE	2.2	2002.04 -		411193.82D
2.2 direct	Z 22 YH	2.2	2003.10 -		411193.82D
2.2 DTI	Y 22 DTR	2.2	2003.10 -		4297.92D
2.2 DTI 16V	Y 22 DTR	2.2	2002.04 - 2004.12		4297.92D

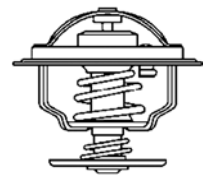

# OPEL

	Engine	Ltr.	Year	Restriction*	Thermostat
<b>VIVARO</b>					
1.9 DI	F9Q 762, F9Q 774	1.9	2001.08 -	Chassis No. →1V699999 →1Y799999	<b>410517.89D</b>
1.9 DI	F9Q 762, F9Q 774	1.9	2001.09 -	Chassis No. 2V600001→ 2Y700001→	<b>410517.83D</b>
1.9 DTI	F9Q 760	1.9	2001.08 -		<b>410517.83D</b>
2.0 16V	F4R 720	2.0	2001.08 - 2007.06	Deckel Thermostatgehäuse	<b>126104 ▲</b>
2.0 16V	F4R 720	2.0	2001.08 - 2007.06		<b>3466.89D</b>
2.0 CDTI	M9R 630, M9R 692, M9R 780, M9R 782, M9R 786, M9R 784, M9R 788	2.0	2006.08 -		<b>411476.83D ▲</b>
2.0 ECOTEC	F4R 820	2.0	2006.08 -		<b>3466.89D</b>
<b>ZAFIRA A</b>					
1.6	Z 16 YNG	1.6	2002.09 - 2005.06		<b>4242.92D</b>
1.6 16V	X 16 XEL	1.6	1999.04 - 2005.06		<b>4208.92D</b>
1.6 16V	Z 16 XE	1.6	1999.04 - 2005.06		<b>4242.92D</b>
1.6 CNG	Z 16 YNG	1.6	2001.09 - 2005.06		<b>4242.92D</b>
1.8	Z 18 XEL	1.8	2003.02 - 2005.06		<b>411578.92D ▲</b>
1.8 16V	X 18 XE1, Z 18 XE	1.8	1999.04 - 2005.06		<b>411578.92D ▲</b>
2.0 DI 16V	X 20 DTL	2.0	1999.10 - 2005.06		<b>4198.92D</b>
2.0 DTI 16V	Y 20 DTH	2.0	2000.09 - 2005.06	Motor no. →17B49754	<b>4198.92D</b>
2.0 DTI 16V	Y 20 DTH	2.0	2000.10 - 2005.06	Motor no. 17B49755→, → 2(2/5/6/8/B/H) 999999	<b>4428.92D</b>
2.0 DTI 16V	Y 20 DTH	2.0	2000.11 - 2005.06	Motor no. 3(2/5/6/8/B/H) 999999 →	<b>4433.92D</b>
2.0 OPC	Z 20 LET, Z 20 LER	2.0	2001.09 - 2005.06		<b>4183.92D</b>
2.2 16V	Z 22 SE	2.2	2000.09 - 2005.06		<b>411193.82D</b>
2.2 DTI 16V	Y 22 DTR	2.2	2002.01 - 2005.06		<b>4433.92D</b>
<b>ZAFIRA B</b>					
1.6	A 16 XER, Z 16 XE1, Z 16 XER, Z 16 XEP	1.6	2005.07 -		<b>4431.105D</b>
1.6 CNG	Z 16 YNG	1.6	2006.01 -		<b>4242.92D</b>
1.6 CNG Turbo	A 16 XNT, Z 16 XNT	1.6	2009.02 -		<b>4357.92D</b>
1.8	Z 18 XER, A 18 XER	1.8	2005.07 -		<b>4431.105D</b>
1.9 CDTI	Z 19 DT, Z 19 DTH, Z 19 DTL	1.9	2005.07 -		<b>410049.88D</b>
2.0	Z 20 LEH, Z 20 LER	2.0	2005.07 -		<b>4183.92D</b>
2.2	Z 22 YH	2.2	2005.07 -		<b>411193.82D</b>
<b>ZAFIRA C</b>					
1.6 CNG	A 16 XNT	1.6	2011.10 -		<b>411059.105D ▲</b>
1.8	A 18 XEL, A 18 XER	1.8	2011.10 -		<b>411059.105D ▲</b>



# PEUGEOT

	Engine	Ltr.	Year	Restriction*	Thermostat
<b>104</b>					
0.9	108 (XV3), 108 (XV5)	0.9	1972.10 - 1983.10		3136.88D50
1.0	108C (XV8)	1.0	1983.09 - 1988.06		3136.82D50
1.1	109 (XW3), 109F (XW7), 121 (XW3S), XW3S	1.1	1976.07 - 1988.06		3136.82D50
1.2	129 (XZ5)	1.2	1979.08 - 1983.06		3136.82D50
1.4	150 (XY6B)	1.4	1979.08 - 1984.06		3136.82D50
<b>106 I</b>					
1.0	CDZ (TU9M), TU9, CDY (TU9M)	1.0	1991.09 - 1996.04		3136.88D50
1.1	HDZ (TU1M)	1.1	1991.09 - 1996.04		3136.88D50
1.3	TU2J2	1.3	1993.10 - 1996.04		3136.82D50
1.4	K5A (TU3), KDX (TU3MC), KDY (TU3M), KFZ (TU3J2, Z)	1.4	1991.08 - 1996.03		3136.88D50
1.4 D	K9Y (TUD3Y)	1.4	1992.09 - 1996.04		4821.89D
1.5 D	VJY (TUD5)	1.5	1994.06 - 1996.04		4821.89D
1.6	NFY (TU5J2), NFZ (TU5JP)	1.6	1993.06 - 1996.04		3136.88D50
<b>106 II</b>					
1.0 i	CDY (TU9M), CDZ (TU9M)	1.0	1996.05 -		3136.88D50
1.1 i	HDZ (TU1M)	1.1	1996.05 -		3136.88D50
1.1 i	HFX (TU1JP)	1.1	1996.05 -		410184.89D
1.4 i	KFX (TU3JP), KFW (TU3JP)	1.4	1996.05 -	Organisations no. →O 08210	3136.88D50
1.4 i	KFX (TU3JP), KFW (TU3JP)	1.4	1996.06 -	Organisations no. O 08211→	410184.89D
1.5 D	VJX (TUD5), VJY (TUD5)	1.5	1996.05 -		4821.89D
1.6 i	NFW (TU5J2), NFY (TU5J2)	1.6	1996.05 -		3136.88D50
1.6 i	NFZ (TU5JP)	1.6	1996.05 -	Organisations no. →O 08210	3136.88D50
1.6 S16	NFX (TU5J4)	1.6	1996.05 -		3136.88D50
<b>205 I</b>					
1.0	108C (XV8)	1.0	1983.02 - 1987.10		3136.82D50
1.1	109F (XW7), 109N (XW7),	1.1	1983.02 - 1994.12		3136.82D50
1.1	HDZ (TU1M)	1.1	1989.10 - 1994.12		3136.88D50
1.4	150 (XY6B), 150B (XY8), 150D (XY7), 150G (XY7), 150H (XY8)	1.4	1983.02 - 1989.05		3136.82D50
1.4 CJ	K1D (TU3A), KAY (TU3CP), KDZ (TU3M), KDY (TU3M)	1.4	1989.01 - 1994.12		3136.88D50
1.6	B1A (XU51C), B1E (XU51C), BAZ (XU5CP)	1.6	1986.08 - 1987.10		3136.82D50
1.6	BDY (XU5M3Z)	1.6	1992.08 - 1994.12		3136.88D50
1.6 CTI / GTI	180A (XU5J), 180Z (XU5J)	1.6	1984.12 - 1987.10	82° Variante	3136.82D50
1.6 CTI / GTI	180A (XU5J), 180Z (XU5J)	1.6	1984.12 - 1987.10	88° Variante	3136.88D50
1.7 Diesel	161A (XUD7)	1.7	1983.08 - 1987.10		4147.80D
1.9 CTI	DFZ (XU9J1)	1.9	1987.10 - 1990.12		3136.82D50
<b>205 II</b>					
1.0	TU9	1.0	1987.10 - 1998.09		3136.88D50
1.1	109N (XW7)	1.1	1987.10 - 1990.10		3136.82D50
1.1	H1B (TU1), HDZ (TU1M)	1.1	1987.10 - 1998.09		3136.88D50
1.3 Rallye	TU24	1.3	1987.10 - 1990.10		3136.88D50
1.4	150 (XY6B), 150B (XY8), 150H (XY8), 150D (XY7), 150G (XY7)	1.4	1987.01 - 1989.05		3136.82D50
1.4	K2B (TU3S)	1.4	1987.06 - 1989.12	82° Variante	3136.82D50

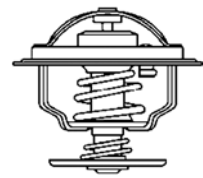

# PEUGEOT

	Engine	Ltr.	Year	Restriction*	Thermostat
1.4	K2B (TU3S)	1.4	1987.06 - 1989.12	88° Variante	<b>3136.88D50</b>
1.4	K1D (TU3A), KAY (TU3CP), KFX (TU-3JP), KDZ (TU3M), KDY (TU3M)	1.4	1987.08 - 1998.09		<b>3136.88D50</b>
1.6	B1A (XU51C), B1E (XU51C), BAZ (XU5CP), BDY (XU5M2Z), BDY (XU5M3Z)	1.6	1987.10 - 1998.09	82° Variante	<b>3136.82D50</b>
1.6	B1A (XU51C), B1E (XU51C), BAZ (XU5CP), BDY (XU5M2Z), BDY (XU5M3Z)	1.6	1987.10 - 1998.09	88° Variante	<b>3136.88D50</b>
1.6 GTI	180A (XU5J), 180Z (XU5J)	1.6	1987.10 - 1989.12	82° Variante	<b>3136.82D50</b>
1.6 GTI	180A (XU5J), 180Z (XU5J)	1.6	1987.10 - 1989.12	88° Variante	<b>3136.88D50</b>
1.7 Diesel	161A (XUD7)	1.7	1987.07 - 1998.09		<b>4147.80D</b>
1.7 TD	A8B (XUD7TE)	1.7	1990.01 - 1992.05		<b>4147.80D</b>
1.7 TD	A8B (XUD7TE)	1.7	1992.06 - 1998.09		<b>4446.83D</b>
1.8 XDT	XUD7T	1.8	1990.08 - 1997.05		<b>4147.80D</b>
1.9 Diesel	DJZ (XUD9Y), XUD9	1.9	1987.08 - 1992.05		<b>4147.80D</b>
1.9 Diesel	DJZ (XUD9Y), XUD9	1.9	1992.06 - 1998.09		<b>4446.83D</b>
1.9 GTI	D2A (XU92C), D6B (XU9JA), DFZ (XU9J1), DKZ (XU9JAZ)	1.9	1987.10 - 1994.07	82° Variante	<b>3136.82D50</b>
1.9 GTI	D2A (XU92C), D6B (XU9JA), DFZ (XU9J1), DKZ (XU9JAZ)	1.9	1987.10 - 1994.07	88° Variante	<b>3136.88D50</b>
<b>205 Kasten</b>					
1.1	H1B (TU1)	1.1	1983.02 - 1987.07	82° Variante	<b>3136.82D50</b>
1.1	H1B (TU1)	1.1	1987.08 - 1990.07	88° Variante	<b>3136.88D50</b>
1.4		1.4	1983.02 - 1987.07		<b>3136.82D50</b>
1.7 Diesel	161A (XUD7)	1.7	1994.03 -		<b>4446.83D</b>
1.8 D	A9A (XUD7)	1.8	1983.02 - 1990.07		<b>4147.80D</b>
<b>206</b>					
1.1	HFX (TU1JP)	1.1	1998.08 -		<b>3463.89D</b>
1.1 i	HFZ (TU1JP), HFX (TU1JP)	1.1	1998.09 -		<b>3463.89D</b>
1.4	KFV (TU3A), KFW (TU3JP)	1.4	2002.07 -		<b>3463.89D</b>
1.4 16V	KFU (ET3J4)	1.4	2003.10 -	Organisations no. →10373	<b>3463.89D</b>
1.4 16V	KFU (ET3J4)	1.4	2003.11 -	Organisations no. 10374→	<b>410705.89D</b>
1.4 i	KFX (TU3JP), KFW (TU3JP)	1.4	1998.09 -		<b>3463.89D</b>
1.4 LPG	KFV (TU3JP)	1.4	2006.05 - 2007.09	Organisations no. →10373	<b>3463.89D</b>
1.4 LPG	KFV (TU3JP)	1.4	2006.06 - 2007.09	Organisations no. 10374→	<b>410705.89D</b>
1.6 16V	NFU (TU5JP4)	1.6	2000.09 -	Organisations no. →10401	<b>3463.89D</b>
1.6 16V	NFU (TU5JP4)	1.6	2000.10 -	Organisations no. 10402→	<b>410705.89D</b>
1.6 i	NFZ (TU5JP)	1.6	1998.09 - 2000.12		<b>3463.89D</b>
1.9 D	WJZ (DW8)	1.9	1998.09 - 2007.05		<b>4446.83D</b>
2.0 16V	RFN (EW10J4)	2.0	2002.07 -		<b>3483.89D</b>
2.0 HDi	RHY (DW10TD)	2.0	2002.07 -		<b>4446.83D</b>
2.0 HDI 90	RHY (DW10TD)	2.0	1999.12 -		<b>4446.83D</b>
2.0 RC	RFK (EW10J4S)	2.0	2003.07 -		<b>3483.89D</b>
2.0 S16	RFN (EW10J4), RFR (DEW10J4)	2.0	1999.04 -		<b>3483.89D</b>
<b>206 +</b>					
1.1	HFX (TU1A), HFX (TU1JP), TU1AE5	1.1	2009.01 -		<b>3463.89D</b>
1.4 i	KFV (TU3A), KFT (TU3A), KFW (TU3A)	1.4	2009.01 -		<b>3463.89D</b>

# PEUGEOT

	Engine	Ltr.	Year	Restriction*	Thermostat
<b>207</b>					
1.4 16V	KFU (ET3J4)	1.4	2006.02 -		<b>410705.89D</b>
1.6	N6A (TU5JP4)	1.6	2008.08 -		<b>410705.89D</b>
1.6 16V	NFU (TU5JP4)	1.6	2006.02 -		<b>410705.89D</b>
<b>305</b>					
1.3	118 (XL5)	1.3	1977.11 - 1986.08	82° Variante	<b>3061.82</b>
1.3	118 (XL5)	1.3	1977.11 - 1986.08	88° Variante	<b>3061.88</b>
1.5	117 (XR5S), 142 (XR5), 142 (XR5A)	1.5	1979.11 - 1990.07		<b>3136.82D50</b>
1.5 Diesel	149 (XID)	1.5	1977.11 - 1982.09		<b>4147.80D</b>
1.6	B1A (XU51C), BAZ (XU5CP)	1.6	1982.10 - 1988.12		<b>3136.82D50</b>
1.6	171 (XU5S)	1.6	1982.10 - 1988.06	82° Variante	<b>3136.82D50</b>
1.6	171 (XU5S)	1.6	1982.10 - 1988.06	88° Variante	<b>3136.88D50</b>
1.9	159 (XU9S), DFZ (XU9J1)	1.9	1982.10 - 1987.10		<b>3136.82D50</b>
1.9 D	D9A (XUD9), 162 (XUD9)	1.9	1982.10 - 1988.07		<b>4147.80D</b>
1.9 Diesel	D9A (XUD9), 162 (XUD9)	1.9	1982.10 - 1988.12		<b>4147.80D</b>
<b>306</b>					
1.1	HDZ (TU1M)	1.1	1993.05 - 2001.05		<b>3136.88D50</b>
1.4	KDX (TU3MC), KFX (TU3JP), KFW (TU3JP)	1.4	1993.05 - 2002.04	Organisations no. →O 08210	<b>3136.88D50</b>
1.4	KDX (TU3MC), KFX (TU3JP), KFW (TU3JP)	1.4	1993.06 - 2002.04	Organisations no. O 08211→	<b>410184.89D</b>
1.6	NFZ (TU5JP)	1.6	1993.05 - 2000.10	Organisations no. →O 08210	<b>3136.88D50</b>
1.6	NFZ (TU5JP)	1.6	1993.06 - 2000.10	Organisations no. O 08211→	<b>410184.89D</b>
1.6	NFT	1.6	2000.10 - 2002.04		<b>3463.89D</b>
1.8	LFZ (XU7JP)	1.8	1995.10 - 1996.07		<b>3136.88D50</b>
1.8	LFZ (XU7JP)	1.8	1996.08 - 2001.05		<b>3136.82D50</b>
1.8 16V	LFY (XU7JP4)	1.8	1997.03 - 2002.04		<b>4450.83D</b>
1.8 D	161 (XUD7), A9A (XUD7)	1.8	1993.04 - 2001.05		<b>4446.83D</b>
1.9 D	XUD9, XUD9TE	1.9	1993.04 - 2002.04		<b>4446.83D</b>
1.9 D	WJY (DW8B), WJZ (DW8)	1.9	1998.09 - 2002.04		<b>4446.83D</b>
1.9 DT	DHY (XUD9TE)	1.9	1993.05 - 2001.05		<b>4450.83D</b>
1.9 SLD	DJY (XUD9A), DJZ (XUD9Y)	1.9	1994.06 - 2001.05		<b>4446.83D</b>
1.9 SRDT	DHY (XUD9TE)	1.9	1994.06 - 2001.05		<b>4446.83D</b>
1.9 STD	XUD9	1.9	1994.02 - 1995.10		<b>4446.83D</b>
1.9 TD	DHY (XUD9TE)	1.9	1997.02 - 2002.04		<b>4450.83D</b>
2.0	RFX (XU10J2)	2.0	1994.03 - 2002.04	Automatikgetriebe	<b>3136.82D50</b>
2.0	RFX (XU10J2)	2.0	1994.03 - 2002.04	Schaltgetriebe	<b>3136.88D50</b>
2.0	RFV (XU10J4R)	2.0	1997.03 - 2002.04		<b>4450.83D</b>
2.0 16V	RFV (XU10J4R)	2.0	1997.03 - 2002.04		<b>4450.83D</b>
2.0 HDI 90	RHY (DW10TD)	2.0	1999.06 - 2002.04		<b>4446.83D</b>
2.0 S16	RFT (XU10J4), RFY (XU10J4Z)	2.0	1993.05 - 2001.05		<b>4450.89D</b>
2.0 S16	RFS (XU10J4RS)	2.0	1996.03 - 2001.05		<b>4450.83D</b>
2.0 XSi	RFX (XU10J2)	2.0	1993.05 - 2001.05	Automatikgetriebe	<b>3136.82D50</b>
2.0 XSi	RFX (XU10J2)	2.0	1993.05 - 2001.05	Schaltgetriebe	<b>3136.88D50</b>
<b>307</b>					
1.4	KFW (TU3JP)	1.4	2000.08 - 2003.09		<b>3463.89D</b>
1.4 16V	KFU (ET3J4)	1.4	2003.11 -	Organisations no. →10436	<b>3463.89D</b>
1.4 16V	KFU (ET3J4)	1.4	2003.12 -	Organisations no. 10437→	<b>410705.89D</b>

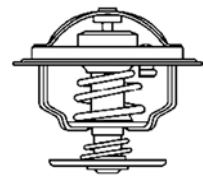

# PEUGEOT

	Engine	Ltr.	Year	Restriction*	Thermostat
1.6 16V	NFU (TU5JP4)	1.6	2000.08 -	Organisations no. →10436	<b>3463.89D</b>
1.6 16V	NFU (TU5JP4)	1.6	2000.09 -	Organisations no. 10437→	<b>410705.89D</b>
1.6 BioFlex	NFU (TU5JP4)	1.6	2007.09 -		<b>3463.89D</b>
2.0	RFN (EW10J4)	2.0	2002.03 -		<b>3483.89D</b>
2.0 16V	RFK (EW10J4S), RFN (EW10J4)	2.0	2000.08 -		<b>3483.89D</b>
2.0 HDi 110	RHS (DW10ATED)	2.0	2000.08 -		<b>4446.83D</b>
2.0 HDi 90	RHY (DW10TD)	2.0	2000.08 -		<b>4446.83D</b>
<b>309</b>					
1.1	H1B (TU1), HDZ (TU1M)	1.1	1989.09 - 1993.12		<b>3136.88D50</b>
1.4	K1D (TU3A), K2B (TU3S), KDY (TU3M), KDZ (TU3M)	1.4	1989.03 - 1993.12		<b>3136.88D50</b>
1.6	XU5CP, XU5J, XU5M, XU5M2Z, XU5M3Z, XU51C. XU52C	1.6	1985.10 - 1993.12	82° Variante	<b>3136.82D50</b>
1.6	XU5CP, XU5J, XU5M, XU5M2Z, XU5M3Z, XU51C. XU52C	1.6	1985.10 - 1993.12	88° Variante	<b>3136.88D50</b>
1.8 Diesel	161A (XUD7)	1.8	1989.07 - 1992.05		<b>4147.80D</b>
1.8 Diesel	161A (XUD7)	1.8	1992.06 - 1993.12		<b>4446.83D</b>
1.8 TD	A8B (XUD7TE)	1.8	1989.08 - 1992.05		<b>4147.80D</b>
1.8 TD	A8B (XUD7TE)	1.8	1992.06 - 1993.12		<b>4446.83D</b>
1.9	XU9J, XU9M, XU9S,	1.9	1985.10 - 1993.12	88° Variante	<b>3136.82D50</b>
1.9	XU9J, XU9M, XU9S,	1.9	1985.10 - 1993.12	82° Variante	<b>3136.82D50</b>
1.9 D	D9A (XUD9), 162 (XUD9)	1.9	1986.06 - 1989.07		<b>4147.80D</b>
1.9 Diesel	D9A (XUD9), DJZ (XUD9Y), 162 (XUD9)	1.9	1989.07 - 1992.05		<b>4147.80D</b>
1.9 Diesel	D9A (XUD9), DJZ (XUD9Y), 162 (XUD9)	1.9	1992.06 - 1993.12		<b>4446.83D</b>
1.9 GTI	D6B (XU9JA), DKZ (XU9JAZ)	1.9	1986.10 - 1993.12	82° Variante	<b>3136.82D50</b>
1.9 GTI	D6B (XU9JA), DKZ (XU9JAZ)	1.9	1986.10 - 1993.12	88° Variante	<b>3136.88D50</b>
<b>405 I</b>					
1.4	K5A (TU3)	1.4	1987.01 - 1992.07		<b>3136.88D50</b>
1.6	XU5CP, XU51C, XU52C, XU52K, XU5M, XU5M2Z, XU5M3Z	1.6	1987.07 - 1992.12	82° Variante	<b>3136.82D50</b>
1.6	XU5CP, XU51C, XU52C, XU52K, XU5M, XU5M2Z, XU5M3Z	1.6	1987.07 - 1992.12	88° Variante	<b>3136.88D50</b>
1.8 D	A8A (XUD7TE)	1.8	1987.10 -		<b>4147.80D</b>
1.8 D	A8A (XUD7TE)	1.8	1991.05 - 1992.07		<b>4446.83D</b>
1.8 DT	A8A (XUD7TE)	1.8	1990.05 -		<b>4147.80D</b>
1.8 DT	A8A (XUD7TE)	1.8	1991.05 - 1992.07		<b>4446.83D</b>
1.8 TD	A8A (XUD7TE), AJZ (XUD7TEY)	1.8	1991.05 -		<b>4147.80D</b>
1.8 TD	A8A (XUD7TE), AJZ (XUD7TEY)	1.8	1991.05 - 1992.08		<b>4446.83D</b>
1.8 Turbo Diesel	A8A (XUD7TE), AJZ (XUD7TEY)	1.8	1988.03 -		<b>4147.80D</b>
1.8 Turbo Diesel	A8A (XUD7TE), AJZ (XUD7TEY)	1.8	1991.05 - 1992.12		<b>4446.83D</b>
1.9	XU92C, XU9J4, XU9M, XU9J1, XU9JAZ	1.9	1987.07 - 1993.12	82° Variante	<b>3136.82D50</b>
1.9	XU92C, XU9J4, XU9M, XU9J1, XU9JAZ	1.9	1987.07 - 1993.12	88° Variante	<b>3136.88D50</b>
1.9 D	DJY (XUD9A), D9B (XUD9A), DJZ (XUD9Y)	1.9	1988.10 - 1992.08		<b>4147.80D</b>
1.9 Diesel	D9B (XUD9A), DJZ (XUD9Y)	1.9	1988.03 - 1992.12		<b>4147.80D</b>

# Thermostats

## PEUGEOT

	Engine	Ltr.	Year	Restriction*	Thermostat
<b>405 II</b>					
1.4	KDX (TU3MC)	1.4	1992.08 - 1996.10		<b>3136.88D50</b>
1.6	BFZ (XU5JP), BDY (XU5M2Z), BDZ (XU5M), BDY (XU5M3Z)	1.6	1992.08 - 1996.10	Automatikgetriebe	<b>3136.82D50</b>
1.6	BFZ (XU5JP), BDY (XU5M2Z), BDZ (XU5M), BDY (XU5M3Z)	1.6	1992.08 - 1996.10	Schaltgetriebe	<b>3136.88D50</b>
1.8	LFZ (XU7JP)	1.8	1992.08 - 1996.10	Automatikgetriebe	<b>3136.82D50</b>
1.8	LFZ (XU7JP)	1.8	1992.08 - 1996.10	Schaltgetriebe	<b>3136.88D50</b>
1.9 D	DJY (XUD9A), DJZ (XUD9Y)	1.9	1992.08 - 1996.10		<b>4446.83D</b>
1.9 D	XUD9	1.9	1993.09 - 1995.12		<b>4446.83D</b>
1.9 TD	DHY (XUD9TE)	1.9	1992.08 - 1996.10		<b>4446.83D</b>
2.0	RFX (XU10J2)	2.0	1992.08 - 1996.10	Automatikgetriebe	<b>3136.82D50</b>
2.0	RFX (XU10J2)	2.0	1992.08 - 1996.10	Schaltgetriebe	<b>3136.88D50</b>
2.0 16V	RFT (XU10J4)	2.0	1994.06 - 1995.10		<b>4450.89D</b>
2.0 MI-16	RFY (XU10J4Z)	2.0	1992.08 - 1995.10		<b>4450.89D</b>
2.0 T 16 X4	RGZ (XU10J4TE, Z)	2.0	1992.08 - 1995.10		<b>4450.89D</b>
<b>406</b>					
1.6	BFZ (XU5JP)	1.6	1995.11 - 2004.05		<b>3136.82D50</b>
1.8	LFX (XU7JB), LFZ (XU7JP)	1.8	1996.10 - 2004.10		<b>3136.82D50</b>
1.8 16V	LFY (XU7JP4)	1.8	1995.11 - 2000.10		<b>4450.83D</b>
1.8 16V	6FZ (EW7J4)	1.8	2000.10 - 2004.10		<b>3483.89D</b>
1.9 D	DHW (XUD9SD)	1.9	1996.10 - 2004.10		<b>4446.83D</b>
1.9 TD	DHY (XUD9TE), DHX (XUD9TE)	1.9	1996.01 - 2004.10		<b>4446.83D</b>
2.0 16V	RFV (XU10J4R)	2.0	1995.11 - 2004.12		<b>4450.83D</b>
2.0 16V	RFR (DEW10J4)	2.0	1999.01 - 2000.10		<b>3483.89D</b>
2.0 16V	RFN (EW10J4)	2.0	2000.08 - 2004.12		<b>3483.89D</b>
2.0 16V HPi	RLZ (EW10D)	2.0	2001.05 - 2004.10		<b>3483.89D</b>
2.0 HDI 110	RHS (DW10ATED), RHZ (DW10ATED)	2.0	1998.06 - 2004.10		<b>4446.83D</b>
2.0 HDI 90	RHY (DW10TD)	2.0	1999.02 - 2004.10		<b>4446.83D</b>
2.0 Turbo	RGX (XU10J2TE)	2.0	1996.04 - 2004.10		<b>3136.82D50</b>
2.1 TD 12V	P8C (XUD11BTE)	2.1	1996.01 - 2004.10	80° Variante	<b>4447.80D</b>
2.1 TD 12V	P8C (XUD11BTE)	2.1	1996.01 - 2004.10	85° Variante	<b>4447.85D</b>
2.2	3FZ (EW12J4)	2.2	2000.07 - 2004.12		<b>3483.89D</b>
2.2 HDi	4HX (DW12TED4, FAP)	2.2	2000.03 - 2004.12		<b>4446.83D</b>
<b>407</b>					
1.8	6FZ (EW7J4)	1.8	2004.05 -		<b>3483.89D</b>
2.0	RFN (EW10J4)	2.0	2004.05 -		<b>3483.89D</b>
2.2	3FZ (EW12J4)	2.2	2004.05 -		<b>3483.89D</b>
2.2 16V	3FY (EW12J4)	2.2	2005.09 -		<b>3483.89D</b>
<b>504</b>					
1.6	XC7P	1.6	1980.01 - 1987.06		<b>3053.75</b>
1.8	XM	1.8	1968.07 - 1989.12		<b>3053.75</b>
1.8 Injection	KF6, KF5	1.8	1968.07 - 1971.02		<b>3053.75</b>
1.9 D	XD4x88	1.9	1973.03 - 1989.12		<b>3053.75</b>
2.0	106 (XN1), 107 (XN2)	2.0	1971.03 - 1986.06	82° Variante	<b>3061.82</b>
2.0	106 (XN1), 107 (XN2)	2.0	1971.03 - 1986.06	88° Variante	<b>3061.88</b>
2.0	XN1	2.0	1971.04 - 1986.07		<b>3053.75</b>
2.0 TI	107 (XN2)	2.0	1971.01 - 1983.06		<b>3061.82</b>
2.1 D	XD4x90	2.1	1971.02 - 1986.07	75° Variante	<b>3053.75</b>
2.1 D	XD4x90	2.1	1971.02 - 1986.07	85° Variante	<b>3053.85</b>
2.3 D	134 (XD2)	2.3	1975.07 - 1989.12		<b>3053.75</b>
2.7	140 (ZMJ)	2.7	1977.10 - 1984.08		<b>4122.87D</b>

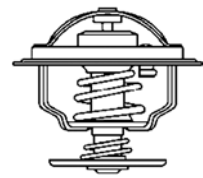

# PEUGEOT

	Engine	Ltr.	Year	Restriction*	Thermostat
<b>505</b>					
1.8	105 (XM7)	1.8	1981.06 - 1985.10	82° Variante	<b>3061.82</b>
1.8	105 (XM7)	1.8	1981.06 - 1985.10	88° Variante	<b>3061.88</b>
2.0	106 (XN1), 106E (XN1A)	2.0	1980.11 - 1985.12	82° Variante	<b>3061.82</b>
2.0	106 (XN1), 106E (XN1A)	2.0	1980.11 - 1985.12	88° Variante	<b>3061.88</b>
2.0 TI, STI	829 (ZEJ)	2.0	1979.08 - 1986.10		<b>4122.87D</b>
2.2	851 (ZDJ), 851X (ZDJL)	2.2	1981.05 - 1984.10		<b>4122.87D</b>
2.2 GTI	851B (ZDJL)	2.2	1983.08 - 1993.12		<b>4122.87D</b>
2.3 Diesel	147 (XD2S)	2.3	1982.04 - 1986.06		<b>3053.75</b>
2.3 Turbo Diesel	147 (XD2S)	2.3	1980.09 - 1986.06		<b>3053.75</b>
2.5 Diesel	155 (XD3)	2.5	1981.06 - 1993.12		<b>4147.80D</b>
2.5 Turbo Diesel	152A (XD3T), 152B (XD3TE)	2.5	1983.10 - 1993.12		<b>4147.80D</b>
2.8 GTI V6	154X (ZN3J)	2.8	1986.06 - 1993.12		<b>4122.87D</b>
<b>604</b>					
2.3 TD	147 (XD2S)	2.3	1979.09 - 1983.05		<b>3053.75</b>
2.5 TD	152A (XD3T)	2.5	1983.08 - 1986.12		<b>4147.80D</b>
2.7 SL	112 (ZM)	2.7	1977.08 - 1983.05	82° Variante	<b>3061.82</b>
2.7 SL	112 (ZM)	2.7	1977.08 - 1983.05	88° Variante	<b>3061.88</b>
2.7 TI, STI	140 (ZMJ)	2.7	1977.08 - 1983.05	82° Variante	<b>3061.82</b>
2.7 TI, STI	140 (ZMJ)	2.7	1977.08 - 1983.05	88° Variante	<b>3061.88</b>
2.8 GTI	154A (ZMJK)	2.8	1983.09 - 1987.07		<b>4122.87D</b>
<b>605</b>					
2.0	R5A (XU102C), RFZ (XU10J2Z)	2.0	1989.06 - 1999.09	82° Variante	<b>3136.82D50</b>
2.0	R5A (XU102C), RFZ (XU10J2Z)	2.0	1989.06 - 1999.09	88° Variante	<b>3136.88D50</b>
2.0 16V	RFV (XU10J4R)	2.0	1994.07 - 1999.09		<b>4450.83D</b>
2.0 Turbo	RGY (XU10J2TE), RGX (XU10J2TE)	2.0	1991.07 - 1999.09	82° Variante	<b>3136.82D50</b>
2.0 Turbo	RGY (XU10J2TE), RGX (XU10J2TE)	2.0	1991.07 - 1999.09	88° Variante	<b>3136.88D50</b>
2.1 D	P9A (XUD11A)	2.1	1991.01 - 1995.07		<b>4447.85D</b>
2.1 TD 12V	P8C (XUD11BTE)	2.1	1994.08 - 1999.09	Automatikgetriebe	<b>4447.80D</b>
2.1 TD 12V	P8C (XUD11BTE)	2.1	1994.08 - 1999.09	Schaltgetriebe	<b>4447.85D</b>
2.1 Turbo Diesel	PHZ (XUD11ATE)	2.1	1989.06 - 1999.09	Automatikgetriebe	<b>4447.80D</b>
2.1 Turbo Diesel	PHZ (XUD11ATE)	2.1	1989.06 - 1999.09	Schaltgetriebe	<b>4447.85D</b>
<b>607</b>					
2.0	RFN (EW10J4)	2.0	2000.02 -		<b>3483.89D</b>
2.0 HDI	RHS (DW10ATED), RHZ (DW10ATED)	2.0	2000.05 -		<b>4446.83D</b>
2.2 16V	3FY (EW12J4), 3FZ (EW12J4)	2.2	2000.02 -		<b>3483.89D</b>
2.2 HDI	4HX (DW12TED4, FAP)	2.2	2000.02 -		<b>4446.83D</b>
<b>806</b>					
1.8	LFW (XU7JP)	1.8	1995.07 - 2002.08	Organisations no. →O 07195	<b>3136.88D50</b>
1.8	LFW (XU7JP)	1.8	1995.08 - 2002.08	Organisations no. →O 07196	<b>3136.82D50</b>
1.9 TD	DHX (XUD9TE), DHY (XUD9TE)	1.9	1995.07 - 2002.08		<b>4446.83D</b>
2.0	RFU (XU10J2)	2.0	1994.06 - 2002.08	Organisations no. →O 07195	<b>3136.88D50</b>
2.0	RFU (XU10J2)	2.0	1994.07 - 2002.08	Organisations no. O 07196→	<b>3136.82D50</b>
2.0 16V	RFV (XU10J4R)	2.0	1998.05 - 2000.09		<b>4450.83D</b>
2.0 16V	RFN (EW10J4)	2.0	2000.09 - 2002.08		<b>3463.89D</b>
2.0 HDI	RHZ (DW10ATED)	2.0	1999.08 - 2002.08		<b>4446.83D</b>

# PEUGEOT

	Engine	Ltr.	Year	Restriction*	Thermostat
2.0 HDI 16V	RHW (DW10ATED4)	2.0	1999.08 - 2002.08		4446.83D
2.0 Turbo	RGX (XU10J2TE)	2.0	1994.06 - 2002.08		3136.82D50
2.1 td 12V	P8C (XUD11BTE)	2.1	1996.06 - 1999.08		4446.83D
<b>807</b>					
2.0	RFN (EW10J4)	2.0	2002.06 -		3483.89D
2.0 16V	RFJ (EW10A)	2.0	2005.09 -		3483.89D
2.0 HDi	DW10ATED4	2.0	2002.06 -		4446.83D
2.2	3FZ (EW12J4)	2.2	2002.06 -		3483.89D
2.2 HDi	4HX (DW12TED4, FAP)	2.2	2002.06 -		4446.83D
<b>1007</b>					
1.4	KFV (TU3JP)	1.4	2005.04 -		410184.89D
1.4 16V	KFU (ET3J4)	1.4	2005.10 -		410705.89D
1.6 16V	NFU (TU5JP4)	1.6	2005.04 -	Organisations no. →10401	410184.89D
1.6 16V	NFU (TU5JP4)	1.6	2005.05 -	Organisations no. 10402→	410705.89D
<b>BIPPER (AA_)</b>					
1.4	KFV (TU3A)	1.4	2008.02 -		3463.89D
<b>BOXER (230)</b>					
1.9 D	D9B (XUD9AU), DJY (XUD9A)	1.9	1994.03 - 2002.04		4446.83D
1.9 DT	XUD9TE	1.9	1996.03 - 1998.09		4450.83D
1.9 TD	D8C (XUD9UTF), DHY (XUD9TE)	1.9	1994.03 - 2002.04		4450.83D
2.0 HDI	RHV (DW10UTD)	2.0	2001.08 - 2002.04		4446.83D
2.0 i	RFW (XU10J2)	2.0	1994.03 - 2002.04		3136.82D50
2.5 D	T9A (DJ5)	2.5	1994.03 - 2002.04	Einbauseite Zylinderkopf	410058.84D
2.5 TD	T8A (DJ5T)	2.5	1994.03 - 2002.04	Einbauseite Zylinderkopf	410058.84D
2.5 TDI	THX (DJ5TED)	2.5	1997.01 - 2002.04	Einbauseite Zylinderkopf	410058.84D
2.8 HDI	8140.43S (F28DTCR)	2.8	2000.11 - 2002.04	82° Variante Serie	4174.82D
2.8 HDI	8140.43S (F28DTCR)	2.8	2000.11 - 2002.04	88° Variante	4174.88D ▲
<b>BOXER (244)</b>					
2.0	RFL (XU10J2U)	2.0	2002.04 -	82° Variante	3136.82D50
2.0	RFL (XU10J2U)	2.0	2002.04 -	88° Variante	3136.88D50
2.0 HDi	RHV (DW10TD), RHV (DW10UTD)	2.0	2002.04 -		4446.83D
2.2 HDi	4HY (DW12UTED)	2.2	2002.04 -		4446.83D
2.8 HDi	8140.43N, 8140.43S (F28DTCR)	2.8	2002.04 -	82° Variante Serie	4174.82D
2.8 HDi	8140.43N, 8140.43S (F28DTCR)	2.8	2002.04 -	88° Variante	4174.88D ▲
<b>BOXER</b>					
2.2 HDi 100	4HV (P22DTE)	2.2	2006.04 -		3497.88D
2.2 HDi 120	4HU (P22DTE)	2.2	2006.04 -		3497.88D
2.2 HDi 130		2.2	2011.03 -		3497.88D
2.2 HDi 150		2.2	2011.03 -		3497.88D
2.3 HDi		2.3	2007.02 -		3171.82D
3.0 HDi		3.0	2006.07 -		410075.79D ▲
3.0 HDi 145		3.0	2010.04 -		410075.79D ▲
3.0 HDi 160	F1CE0481D (FG30DT)	3.0	2006.04 -		410075.79D ▲
3.0 HDi 175		3.0	2011.03 -		410075.79D ▲

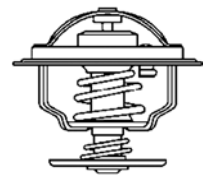

# PEUGEOT

	Engine	Ltr.	Year	Restriction*	Thermostat
<b>EXPERT</b>					
1.9 D	XUD9TE	1.9	1995.10 - 1998.05		4446.83D
1.9 D	D9B (XUD9AU), WJY (DW8B), WJZ (DW8)	1.9	1996.02 - 2003.11		4446.83D
1.9 D 70	WJY (DW8B), WJZ (DW8)	1.9	1998.12 -		4446.83D
1.9 TD	D8B (XUD9TE), DHX (XUD9TE)	1.9	1996.02 -		4446.83D
2.0	RFN (EW10J4)	2.0	2000.07 -		3483.89D
2.0 HDI	DW10ATED	2.0	2000.07 -		4446.83D
<b>EXPERT Tepee (VF3V_)</b>					
2.0 16V	RFJ (EW10A), RFH (EW10A)	2.0	2007.01 -		3483.89D
<b>J5 (280)</b>					
1.8	169B (XM7T)	1.8	1983.01 - 1988.11	82° Variante	3061.82
1.8	169B (XM7T)	1.8	1983.01 - 1988.11	88° Variante	3061.88
2.0	170 (XN1T), 170B (XN1T)	2.0	1981.09 - 1990.09	82° Variante	3061.82
2.0	170 (XN1T), 170B (XN1T)	2.0	1981.09 - 1990.09	88° Variante	3061.88
2.5 D	CRD93 (U25, 661)	2.5	1981.09 - 1990.09		3033.84D ▲
<b>J5 (290)</b>					
2.0	170D (XN1TACP)	2.0	1990.10 - 1994.02	82° Variante	3061.82
2.0	170D (XN1TACP)	2.0	1990.10 - 1994.02	88° Variante	3061.88
2.5 D	CRD93 (U25, 661)	2.5	1990.10 - 1994.03		3033.84D ▲
2.5 TD	CRD93LS (U25, 673)	2.5	1990.10 - 1994.03		3033.84D ▲
<b>J9</b>					
1.6	XC7P	1.6	1980.03 - 1987.06		3053.75
2.0	XN1P	2.0	1980.03 - 1987.06		3053.75
2.1 D	XDPX90	2.1	1980.03 - 1987.06		3053.75
2.3 D	XD2PX94	2.3	1980.03 - 1982.07		3053.75
2.5 D	XD3P	2.5	1982.07 - 1987.06		4147.80D
<b>PARTNER</b>					
1.1	HDZ (TU1M)	1.1	1996.06 -		3136.88D50
1.1	HFX (TU1JP)	1.1	1996.06 -		410184.89D
1.4	KFX (TU3JP), TU32, KFW (TU3JP)	1.4	1996.06 -	Organisations no. →O 08210	3136.88D50
1.4	KFX (TU3JP), TU32, KFW (TU3JP)	1.4	1996.07 -	Organisations no. O 08211→	410184.89D
1.4 BiFuel	KFW (TU3JP)	1.4	2003.04 -		3463.89D
1.6	NFR (TU5JP4B), NFU (TU5JP4)	1.6	2008.04 -		410705.89D
1.6 16V	NFU (TU5JP4)	1.6	2001.07 -		410184.89D
1.6 Flex	NFU (TU5JP4)	1.6	2008.09 -		410705.89D
1.8	LFX (XU7JB)	1.8	1997.03 - 2000.08		3136.82D50
1.8 D	A9A (XUD7)	1.8	1996.06 - 1998.02		4446.83D
1.9 D	DJY (XUD9A), WJY (DW8B), WJZ (DW8)	1.9	1996.05 -		4446.83D
2.0 HDi	RHY (DW10TD)	2.0	2000.02 -		4446.83D
<b>PARTNER Tepee</b>					
1.6	NFR (TU5JP4B), NFU (TU5JP4)	1.6	2008.04 -		410705.89D
1.6 Flex	TU5JP	1.6	2008.09 -		410705.89D



# Thermostats

## PIAGGIO

Engine

Ltr.

Year

Restriction\*

Thermostat

### PORTER

0.5 D	Lombardini	0.5	2008.06 -		<b>4007.80D</b>
1.2 D	LDW1204	1.2	1995.05 -		<b>4007.80D</b>
1.4 D	LDW1404	1.4	1998.04 -		<b>4007.80D</b>

### QUARGO

0.7 D	LDW702	0.7	2004.01 -		<b>4007.80D</b>
-------	--------	-----	-----------	--	-----------------

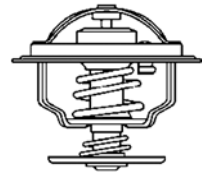

# PLYMOUTH

	Engine	Ltr.	Year	Restriction*	Thermostat
<b>NEON</b>					
2.0 16V	ECB, ECC		1994.05 - 1999.08		<b>410262.91D</b>
2.0 16V	ECH		1999.09 -		<b>410262.91D</b>
<b>VOYAGER</b>					
2.5 TD	ENC		1995.01 - 2001.03		<b>4158.80D</b>

**PORSCHE**

Engine

Ltr.

Year

Restriction\*

Thermostat

**911 (996, 997)**

3.4 Carrera	M 96	3.4	1997.09 - 2005.08	71° Variante	<b>4249.71D ▲</b>
3.4 Carrera	M 96	3.4	1997.09 - 2005.08	83° Variante Serie	<b>4249.83D</b>
3.4 Carrera 4	M 96	3.4	1997.09 - 2005.08	71° Variante	<b>4249.71D ▲</b>
3.4 Carrera 4	M 96	3.4	1997.09 - 2005.08	83° Variante Serie	<b>4249.83D</b>
3.6	M 96.03	3.6	2001.12 - 2005.08	71° Variante	<b>4249.71D ▲</b>
3.6	M 96.03	3.6	2001.12 - 2005.08	83° Variante Serie	<b>4249.83D</b>
3.6 Carrera	M 96.03, M 96.05	3.6	2001.10 -	71° Variante	<b>4249.71D ▲</b>
3.6 Carrera	M 96.03, M 96.05	3.6	2001.10 -	83° Variante Serie	<b>4249.83D</b>
3.6 Carrera 4	M 96.03, M 96.05	3.6	2001.10 -	71° Variante	<b>4249.71D ▲</b>
3.6 Carrera 4	M 96.03, M 96.05	3.6	2001.10 -	83° Variante Serie	<b>4249.83D</b>
3.6 Carrera 4 S	M 96.03	3.6	2002.06 - 2005.08	71° Variante	<b>4249.71D ▲</b>
3.6 Carrera 4 S	M 96.03	3.6	2002.06 - 2005.08	83° Variante Serie	<b>4249.83D</b>
3.6 Carrera S	M 96.03	3.6	2002.06 - 2005.08	71° Variante	<b>4249.71D ▲</b>
3.6 Carrera S	M 96.03	3.6	2002.06 - 2005.08	83° Variante Serie	<b>4249.83D</b>
3.6 GT2	M 96.70	3.6	2001.04 - 2005.08	71° Variante	<b>4249.71D ▲</b>
3.6 GT2	M 96.70	3.6	2001.04 - 2005.08	83° Variante Serie	<b>4249.83D</b>
3.6 GT3	M 96.76, M 96.79	3.6	1999.03 - 2005.08	71° Variante	<b>4249.71D ▲</b>
3.6 GT3	M 96.76, M 96.79	3.6	1999.03 - 2005.08	83° Variante Serie	<b>4249.83D</b>
3.6 Turbo 4	M 96.70	3.6	2000.06 - 2005.08	71° Variante	<b>4249.71D ▲</b>
3.6 Turbo 4	M 96.70	3.6	2000.06 - 2005.08	83° Variante Serie	<b>4249.83D</b>
3.6 Turbo 4 S	M 96.70	3.6	2003.02 - 2005.08	71° Variante	<b>4249.71D ▲</b>
3.6 Turbo 4 S	M 96.70	3.6	2003.02 - 2005.08	83° Variante Serie	<b>4249.83D</b>
3.8 Carrera 4 S	M 97.01, M 97.01S	3.8	2004.07 -	71° Variante	<b>4249.71D ▲</b>
3.8 Carrera 4 S	M 97.01, M 97.01S	3.8	2004.07 -	83° Variante Serie	<b>4249.83D</b>
3.8 Carrera S	M 97.01, M 97.01S	3.8	2004.07 -	71° Variante	<b>4249.71D ▲</b>
3.8 Carrera S	M 97.01, M 97.01S	3.8	2004.07 -	83° Variante Serie	<b>4249.83D</b>

**924**

2.0	XJ, XK	2.0	1975.11 - 1989.08		<b>4006.82D</b>
2.0 Carrera GT	M 31.50	2.0	1980.06 - 1986.10		<b>4256.83D60</b>
2.0 Turbo	M 31.01, M 31.03	2.0	1978.11 - 1986.10		<b>4006.82D</b>
2.5 S	M 44.01, M 44.03, M 44.07, M 44.08, M 44.09, M 44.10	2.5	1981.10 - 1988.07		<b>4256.83D60</b>

**928**

4.5	M 28.10, M 28.09, M 28.01, M 28.02	4.5	1977.09 - 1982.08		<b>4161.83</b>
4.7 S	M 28.11, M 28.12, M 28.21, M 28.22	4.7	1979.09 - 1986.07		<b>4161.83</b>
5.0 GT	M 28.47	5.0	1989.01 - 1991.07		<b>4161.83</b>
5.0 S	M 28.45, M 28.46	5.0	1985.09 - 1986.12		<b>4161.83</b>
5.0 S 4	M 28.41, M 28.42	5.0	1986.08 - 1991.07		<b>4161.83</b>
5.0 S, S 4	M 28.41, M 28.42	5.0	1986.08 - 1991.07		<b>4161.83</b>
5.4 GTS	M 28.49, M 28.50	5.4	1991.08 - 1995.11		<b>4161.83</b>

**944**

2.5	M 44.01, M 44.02, M 44.03, M 44.04, M 44.05, M 44.06, M 44.07, M 44.08, M 44.09, M 44.10	2.5	1981.06 - 1990.12		<b>4256.83D60</b>
2.5 S	M 44.40	2.5	1986.08 - 1988.07		<b>4256.83D60</b>
2.5 Turbo	M 44.50, M 44.51, M 44.52	2.5	1985.08 - 1991.07		<b>4256.83D60</b>
2.7	M 44.12, M 44.11	2.7	1988.11 - 1989.08		<b>4256.83D60</b>
3.0 S 2	M 44.41	3.0	1988.12 - 1991.07		<b>4256.83D60</b>

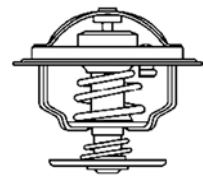

# PORSCHE

	Engine	Ltr.	Year	Restriction*	Thermostat
<b>968</b>					
3.0	M 44.43, M 44.44	3.0	1991.06 - 1995.11		<b>4256.83D60</b>
3.0 Turbo S		3.0	1993.03 - 1995.11		<b>4256.83D60</b>
<b>BOXSTER (986)</b>					
2.5	M 96.20	2.5	1996.09 - 1999.08	71° Variante	<b>4249.71D ▲</b>
2.5	M 96.20	2.5	1996.09 - 1999.08	83° Variante Serie	<b>4249.83D</b>
2.7	M 96.22, M 96.23	2.7	1999.08 - 2004.12	71° Variante	<b>4249.71D ▲</b>
2.7	M 96.22, M 96.23	2.7	1999.08 - 2004.12	83° Variante Serie	<b>4249.83D</b>
S 3.2	M 96.21, M 96.24	3.2	1999.08 - 2004.12	71° Variante	<b>4249.71D ▲</b>
S 3.2	M 96.21, M 96.24	3.2	1999.08 - 2004.12	83° Variante Serie	<b>4249.83D</b>
<b>BOXSTER (987)</b>					
2.7	M 96.25	2.7	2004.11 -	71° Variante	<b>4249.71D ▲</b>
2.7	M 96.25	2.7	2004.11 -	83° Variante Serie	<b>4249.83D</b>
S 3.2	M 96.26	3.2	2004.11 -	71° Variante	<b>4249.71D ▲</b>
S 3.2	M 96.26	3.2	2004.11 -	83° Variante Serie	<b>4249.83D</b>
<b>CAYENNE</b>					
3.2	M02.2Y	3.2	2003.10 -		<b>4455.80D</b>

# Thermostats

## PROTON

	Engine	Ltr.	Year	Restriction*	Thermostat
<b>PERSONA 300</b>					
313 i	G 13 B	1.3	1996.03 -		4637.82D
315 GLi/GLSi	4 G 15 M	1.5	1996.03 -		3119.88D4
315 GLSi	G 15 B	1.5	1996.09 -		4637.82D
316	4 G 92	1.6	1996.03 -		4637.82D
318 16V GTI	4 G 93 (DOHC)	1.8	1996.03 -		4637.82D
<b>PERSONA 400</b>					
1.2		1.2	2005.10 -		3166.89D
413		1.3	1994.01 -		4637.82D
413 GLSi	4 G 13	1.3	1994.01 -		4637.82D
415 GLi/GLSi	4 G 15	1.5	1994.01 -		4637.82D
416 GLXi	4 G 92	1.6	1994.01 -		4637.82D
416 i	4 G 92	1.6	1995.12 -		4637.82D
418	4 G 93 (DOHC)	1.8	1996.05 -		4637.82D
418	4 G 93 (DOHC)	1.8	1996.05 -		4637.82D
<b>WIRA</b>					
1.3	4 G 13	1.3	2000.08 -		3119.88D4
1.5	4 G 15 M	1.5	2000.08 -		3119.88D4

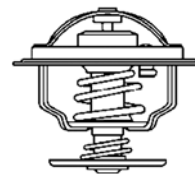

# RENAULT

	Engine	Ltr.	Year	Restriction*	Thermostat
<b>4</b>					
0.8	800 01, 800 705, 839 706, B1B 707	0.8	1962.10 - 1989.07		<b>3029.86</b>
1.0	689 710, C1C 708	1.0	1985.12 - 1993.12		<b>3029.86</b>
1.1	C1E, 688 711, 688 712	1.1	1976.10 - 1989.07		<b>3029.86</b>
<b>5</b>					
0.8	800 710	0.8	1972.10 - 1984.12		<b>3029.83</b>
1.0	689 710	1.0	1972.01 - 1985.12		<b>3029.83</b>
1.1	C1E 726, 688 713	1.1	1980.09 - 1985.12		<b>3029.83</b>
1.3	810 719, 810 725, 810 726, 810 729	1.3	1975.09 - 1984.09		<b>3029.83</b>
1.4	847 712, 847 725, C2J 713	1.4	1982.01 - 1985.12		<b>3029.83</b>
1.4 Alpine A5	840 725	1.4	1977.09 - 1981.09		<b>3029.83</b>
1.4 Alpine Turbo	840 726, C6J 750	1.4	1981.10 - 1985.01		<b>3029.83</b>
1.4 Turbo	840 730	1.4	1980.06 - 1985.01		<b>3029.83</b>
<b>5 SUPER (B/C/S40)</b>					
1.0	C1C 700	1.0	1984.10 - 1988.10		<b>3029.86</b>
1.1	C1E	1.1	1984.10 - 1996.12		<b>3029.86</b>
1.2	C1G	1.2	1987.01 - 1996.12		<b>3029.86</b>
1.4	C1J, C2J, C3J	1.4	1984.10 - 1990.08		<b>3029.86</b>
1.4 Turbo	C1J 782, C1J 784, C1J 788	1.4	1985.04 - 1990.08		<b>3029.86</b>
1.4 Turbo GT	840 730	1.4	1985.01 - 1991.05		<b>3029.86</b>
1.6 D	F8M 720, F8M 730	1.6	1984.10 - 1996.12		<b>3470.89D50</b>
1.7	F2N 742, F2N 740, F3N 716 , F3N 717	1.7	1986.10 - 1995.03		<b>3470.89D50</b>
1.7 i	F3N 722, F3N 702	1.7	1986.10 - 1991.08		<b>3470.89D50</b>
<b>6</b>					
0.8	800.02	0.8	1969.10 - 1980.04		<b>3029.83</b>
1.1	688.10	1.1	1970.08 - 1987.04		<b>3029.83</b>
<b>9</b>					
1.1	C1E 715, C1E 720	1.1	1981.09 - 1987.05		<b>3029.86</b>
1.2	C1G 700, C1G 710	1.2	1985.09 - 1988.12		<b>3029.86</b>
1.4	C1J, C2J	1.4	1981.12 - 1988.12		<b>3029.86</b>
1.4 Turbo	C1J 764, C1J 760	1.4	1984.04 - 1989.12		<b>3029.83</b>
1.6 D	F8M 730, F8M 700, F8M 720	1.6	1982.10 - 1988.12		<b>3136.82D50</b>
1.7	F2N, FN3	1.7	1984.09 - 1988.12		<b>3470.89D50</b>
<b>11</b>					
1.1	C1E 715, C1E 720	1.1	1983.03 - 1986.06		<b>3029.86</b>
1.2	C1G 700, C1G 710	1.2	1984.10 - 1988.12		<b>3029.86</b>
1.4	C1J, C2J	1.4	1983.03 - 1988.12		<b>3029.86</b>
1.4 Turbo	C1J 764, C1J 760, C1J 770, C1J 782	1.4	1984.04 - 1988.12		<b>3029.86</b>
1.6 D	F8M 730, F8M 700, F8M 720	1.6	1983.08 - 1988.12		<b>3136.82D50</b>
1.7	F2N, F3N	1.7	1983.10 - 1988.12		<b>3470.89D50</b>
<b>12</b>					
1.3	810	1.3	1972.08 - 1980.08		<b>3029.89</b>
1.4	C1J 791	1.4	1976.08 - 1979.05		<b>3029.89</b>
1.6	821.20, 807.20	1.6	1970.08 - 1974.12		<b>3029.78</b>

# RENAULT

	Engine	Ltr.	Year	Restriction*	Thermostat
<b>14</b>					
1.2	129	1.2	1976.05 - 1983.12		<b>3136.82D50</b>
1.4	150, X5J	1.4	1979.09 - 1983.12		<b>3136.82D50</b>
<b>15</b>					
1.3	810.05	1.3	1972.03 - 1980.10		<b>3029.83</b>
1.6	807.10	1.6	1972.03 - 1980.10		<b>3029.86</b>
<b>16</b>					
1.5		1.5	1965.09 - 1975.10		<b>3029.86</b>
1.6	807, 821, 843.04, 807, 807.05	1.6	1968.09 - 1980.08		<b>3029.86</b>
<b>17</b>					
1.6	807.10, 844.12	1.6	1972.03 - 1980.10		<b>3029.86</b>
<b>18</b>					
1.4	847 720, 847 722	1.4	1978.04 - 1986.07		<b>3029.86</b>
1.6	841, A2M, A6M	1.6	1978.04 - 1986.07		<b>3029.86</b>
1.6 Turbo	807 727, A5L 718, A5L 717	1.6	1980.10 - 1986.07		<b>3029.86</b>
1.6 Turbo Inj.	A7L 752	1.6	1982.09 - 1986.07		<b>3029.78</b>
2.0	J6R 714, J6R 716	2.0	1983.05 - 1986.12		<b>4122.87D</b>
2.1 Diesel	852 710, J8S 711	2.1	1979.05 - 1986.07		<b>4147.80D</b>
2.1 TD	J8S 712	2.1	1981.11 - 1986.07		<b>4147.80D</b>
2.2 i	J7T 718	2.2	1984.06 - 1986.07		<b>4122.87D</b>
<b>19</b>					
1.2	C1G 730	1.2	1988.01 - 1995.12		<b>3029.86</b>
1.2	E7F 730	1.2	1992.05 - 1994.09		<b>3469.91D</b>
1.4	C1J, C2J, C3J	1.4	1988.07 - 1995.12		<b>3029.86</b>
1.4	E6J, E7J	1.4	1990.09 - 1995.12		<b>3469.91D</b>
1.6	K4M 734	1.6	1997.10 - 1999.06	Deckel Thermostatgehäuse	<b>126104 ▲</b>
1.6	K4M 734	1.6	1997.10 - 1999.06		<b>3466.89D</b>
1.6	K4M 744	1.6	1998.07 - 2001.06	Deckel Thermostatgehäuse, Motor no. →011212	<b>126104 ▲</b>
1.6	K4M 744	1.6	1998.07 - 2001.06	Motor no. →011212	<b>3466.89D</b>
1.7	F3N	1.7	1988.07 - 1995.12		<b>3470.89D50</b>
1.8	F3P	1.8	1992.04 - 1995.12		<b>3470.89D50</b>
1.8 16V	F7P 704	1.8	1989.06 - 1995.12		<b>3470.89D50</b>
1.9 D	F8Q 706, F8Q 742	1.9	1988.09 - 1995.12		<b>3470.89D50</b>
1.9 D	F8Q 744	1.9	1992.05 - 1995.11		<b>4147.80D</b>
1.9 DT	F8Q 610	1.9	1990.09 - 1992.04		<b>3470.89D50</b>
1.9 DT	F8Q 740	1.9	1990.09 - 1992.04		<b>4147.80D</b>
1.9 dT	F8Q 744	1.9	1992.04 - 1995.12		<b>4147.80D</b>
1.9 TD	F8Q 740	1.9	1990.09 - 1992.04		<b>3470.89D50</b>
<b>19 Cabriolet</b>					
1.7	F2N, F3N	1.7	1991.07 - 1993.09		<b>3470.89D50</b>
1.8	F3P	1.8	1992.04 - 1996.06		<b>3470.89D50</b>
1.8 16V	F7P 704	1.8	1991.07 - 1996.06		<b>3470.89D50</b>

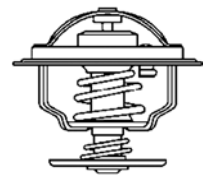

# RENAULT

	Engine	Ltr.	Year	Restriction*	Thermostat
<b>19 Kasten</b>					
1.2	C1G 730	1.2	1988.01 - 1995.12		3029.86
1.4	E6J 700	1.4	1988.01 - 1995.12		3469.91D
1.9 D	F8Q 706, F8Q 742	1.9	1988.01 - 1995.12		3470.89D50
1.9 dT	F8Q 740	1.9	1992.03 - 1995.12		4147.80D
<b>20</b>					
1.6	843 720, 843 721	1.6	1975.10 - 1983.12		3053.85
2.0	829	2.0	1977.10 - 1983.12		4122.87D
2.1 Diesel	852	2.1	1980.10 - 1983.12		4147.80D
2.1 TD	J8S 702	2.1	1982.01 - 1983.12		4147.80D
2.2	851 700	2.2	1980.10 - 1983.12		4122.87D
<b>21</b>					
1.4	C2J 770	1.4	1989.09 - 1993.10		3029.86
1.7	F2N, F3N	1.7	1986.03 - 1994.06		3470.89D50
1.9 D	F8Q 710	1.9	1989.08 - 1994.08		3136.82D50
2.2	J7T 754, J7T 755	2.2	1986.06 - 1994.06		3029.89
<b>21 Kasten</b>					
1.7	F2N 710	1.7	1986.06 - 1995.04		3470.89D50
1.9 D	F8Q 710	1.9	1986.06 - 1994.08		3136.82D50
<b>21</b>					
2.1 D	J8S 600, J8S 740, J8S 740, J8S 784	2.1	1986.03 - 1994.08		4147.80D
2.0	J6R, J7R	2.0	1986.03 - 1994.06		3029.89
2.0 Turbo	J7R 752, J7R 756	2.0	1987.04 - 1993.10		3029.89
2.1 Turbo-D	J8S 788, J8S 786, J8S 714	2.1	1986.03 - 1994.06		4147.80D
<b>25</b>					
2.0	J6R J7R	2.0	1984.04 - 1993.12		4122.87D
2.0 12V	J7R 721, J7R 720, J7R 726	2.0	1988.06 - 1993.12		4122.87D
2.1 Diesel	J8S 706, J8S 736	2.1	1984.04 - 1992.12		4147.80D
2.1 Turbo-D	J8S 708, J8S 738	2.1	1984.04 - 1992.12		4147.80D
2.2	J7T	2.2	1984.04 - 1989.12		4122.87D
2.4 V6 Turbo	Z7U 702	2.4	1984.10 - 1990.05		4122.87D
2.5 V6 Turbo	Z7U 700	2.5	1990.01 - 1992.12		4122.87D
2.7 V6 Injection	Z7V 711, Z7V 709, Z7V 708	2.7	1984.04 - 1989.08		4122.87D
2.8 V6	Z7W 700	2.8	1987.06 - 1990.02		4122.87D
2.8 V6 Injection	Z7W 702, Z7W 706, Z7W 707, Z7W 709	2.8	1986.06 - 1992.12		4122.87D
<b>30</b>					
2.1 Turbo-D	J8S 702	2.1	1982.02 - 1986.03		4147.80D
2.6	112, 140, 144	2.6	1975.02 - 1984.01		4122.87D
<b>AVANTIME</b>					
2.0 16V Turbo	F4R 760, F4R 761	2.0	2001.11 - 2003.05		3466.89D
<b>B</b>					
70	8140.61.235	2.4	1983.01 - 1990.12		4151.79D
90	8140.21.235 IDS, 8140.27.2530 IDS	2.4	1986.04 - 1992.01		4151.76D



# RENAULT

	Engine	Ltr.	Year	Restriction*	Thermostat
<b>CLIO I</b>					
1.1	C1E 700	1.1	1991.01 - 1998.09		<b>3029.86</b>
1.2	E7F	1.2	1990.05 - 1998.09		<b>3469.91D</b>
1.2	C3G 720	1.2	1994.06 - 1998.02		<b>3029.89</b>
1.2	D7F 730	1.2	1996.01 - 1998.09		<b>3174.89D</b>
1.4	E7J	1.4	1991.01 - 1998.09		<b>3469.91D</b>
1.7	F2N 770	1.7	1991.01 - 1993.12		<b>3470.89D50</b>
1.8	F3P	1.8	1991.01 - 1998.09		<b>3470.89D50</b>
1.8 16V	F7P 722	1.8	1991.01 - 1996.03		<b>3470.89D50</b>
1.8 Rsi	F3P 712, F3P 758	1.8	1993.01 - 1998.09		<b>3470.89D50</b>
1.9 D	F8Q 678, F8Q 730, F8Q 732	1.9	1991.01 - 1998.09		<b>3470.89D50</b>
Williams	F7R 700	2.0	1994.01 - 1998.09		<b>3470.89D50</b>
<b>CLIO II</b>					
1.1	D7F 720, D7F 726, D7F 746	1.1	1998.09 -		<b>3166.89D</b>
1.2	D7F	1.2	1998.09 - 2009.06		<b>3166.89D</b>
1.2 16V	D4F	1.2	2001.06 -		<b>3166.89D</b>
1.4	E7J 780	1.4	1998.09 - 2005.05	Deckel Thermostatgehäuse	<b>126104 ▲</b>
1.4	E7J 780	1.4	1998.09 - 2005.05		<b>3466.89D</b>
1.4 16V	K4J 711, K4J 712, K4J 713	1.4	1999.10 -	Deckel Thermostatgehäuse	<b>126104 ▲</b>
1.4 16V	K4J 710	1.4	1999.10 -	Deckel Thermostatgehäuse, Motor no. →011212	<b>126104 ▲</b>
1.4 16V	K4J 711, K4J 712, K4J 713	1.4	1999.10 -		<b>3466.89D</b>
1.4 16V	K4J 710	1.4	1999.10 -	Motor no. →011212	<b>3466.89D</b>
1.5 dCi	K9K 700, K9K 702, K9K 704, K9K 710	1.5	2001.06 -		<b>411043.89D</b>
1.5 dCi	K9K 714, K9K 716, K9K 718, K9K 740	1.5	2003.11 -		<b>411039.83D</b>
1.6	K4M 746, K7M 744, K7M 745	1.6	1998.09 -	Deckel Thermostatgehäuse	<b>126104 ▲</b>
1.6	K4M 746, K7M 744, K7M 745	1.6	1998.09 -		<b>3466.89D</b>
1.6 16V	K4M 743, K4M 748, K4M 740, K4M 742, K4M 708, K4M 745	1.6	1998.09 -	Deckel Thermostatgehäuse	<b>126104 ▲</b>
1.6 16V	K4M 744	1.6	1998.09 -	Deckel Thermostatgehäuse, Motor no. →011212	<b>126104 ▲</b>
1.6 16V	K4M 743, K4M 748, K4M 740, K4M 742, K4M 708, K4M 745	1.6	1998.09 -		<b>3466.89D</b>
1.6 16V	K4M 744	1.6	1998.09 -	Motor no. →011212	<b>3466.89D</b>
1.9 D	F8Q 630	1.9	1998.09 - 2005.05		<b>3470.89D50</b>
1.9 D	F8Q 662	1.9	1999.03 - 2000.01		<b>410530.89D</b>
1.9 D	F8Q 632	1.9	2000.02 - 2000.11		<b>410518.89D</b>
1.9 D	F8Q 632	1.9	2000.11 - 2001.05		<b>410530.89D</b>
1.9 dTi	F9Q 780	1.9	1999.12 - 2000.05		<b>410518.89D</b>
1.9 dTi	F9Q 780	1.9	2000.06 - 2005.05		<b>3470.89D50</b>
2.0 16V Sport	F4R 730, F4R 738	2.0	2000.02 -		<b>3466.89D</b>
<b>CLIO III</b>					
1.2	D7F 766	1.2	2005.05 - 2009.06		<b>3166.89D</b>
1.2 16V	D4F 740, D4F 742, D4F 784	1.2	2005.06 -		<b>3166.89D</b>
1.5 dCi	K9K 750	1.5	2005.05 -		<b>411475.89D ▲</b>
1.5 dCi	K9K 714, K9K 764, K9K 766, K9K 768	1.5	2005.06 -	4 polig	<b>411040.83D</b>
1.5 dCi	K9K 772	1.5	2005.06 -		<b>411042.89D</b>
1.5 dCi	K9K 770	1.5	2010.08 -	2 polig	<b>411442.83D ▲</b>
2.0 16V	M4R 700, M4R 701	2.0	2006.09 -		<b>411241.82D</b>

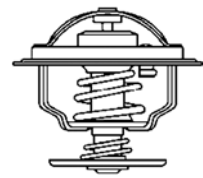

# RENAULT

	Engine	Ltr.	Year	Restriction*	Thermostat
<b>CLIO IV</b>					
1.2 16V	D4F 740	1.2	2012.11 -		3166.89D
<b>CLIO Grandtour (KR0/1_)</b>					
1.2 16V	D4F 740, D4F 784	1.2	2008.02 -		3166.89D
1.5 dCi	K9K 714, K9K 768	1.5	2008.02 - 2010.01	4 polig	411040.83D
1.5 dCi	K9K 764, K9K 766	1.5	2008.02 -	4 polig	411040.83D
1.5 dCi	K9K 772	1.5	2008.02 -		411042.89D
1.5 dCi	K9K 764, K9K 766, K9K 770	1.5	2008.02 -	2 polig	411442.83D ▲
1.5 dCi	K9K 714, K9K 768	1.5	2010.01 -	2 polig	411442.83D ▲
1.5 dCi	K9K 752	1.5	2010.02 -		411477.89D ▲
<b>DUSTER</b>					
1.6 16V	K4M 616, K4M 690, K4M 718	1.6	2011.01 -	Deckel Thermostatgehäuse	126104 ▲
1.6 16V	K4M 616, K4M 690, K4M 718	1.6	2011.01 -		3466.89D
1.6 Flex	K4M 690	1.6	2011.10 -	Deckel Thermostatgehäuse	126104 ▲
1.6 Flex	K4M 690	1.6	2011.10 -		3466.89D
<b>ESPACE I</b>					
2.0	J6R 234, J6R 236, J6R 734	2.0	1984.07 - 1990.12		4122.87D
2.0 i	J7R 760	2.0	1988.03 - 1992.12		4122.87D
2.1 TD	J8S 774, J8S 240	2.1	1984.10 - 1990.12		4147.80D
2.2	J7T 770	2.2	1986.07 - 1990.12		4122.87D
<b>ESPACE II</b>					
2.0	J7R 768	2.0	1991.01 - 1996.10		3029.89
2.1 TD	J8S 776, J8S 772, J8S 778, J8S 610, J8S 612	2.1	1991.01 - 1996.10		4147.80D
2.2	J7T 772, J7T 776, J7T 773	2.2	1991.01 - 1996.12		3029.89
2.8 V6	Z7W 717, Z7W 712, Z7W 713	2.8	1991.01 - 1996.10		4122.87D
<b>ESPACE III</b>					
1.9 dTi	F9Q 722	1.9	1999.02 - 2000.05	mit Gehäuse	410518.89D
1.9 dTi	F9Q 722	1.9	2000.06 - 2001.03	ohne Gehäuse	3470.89D50
1.9 dTi	F9Q 722	1.9	2000.06 - 2001.03	mit Gehäuse	410518.89D
1.9 dTi	F9Q 722	1.9	2001.03 - 2002.10	mit Gehäuse	410517.89D
2.0	F3R 769, F3R 728, F3R 742, F3R 729, F3R 768, F4R 701, F4R 700	2.0	1996.11 - 2002.10		3470.89D50
2.0 16V	F4R 701, F4R 700	2.0	1998.10 - 2002.10		3466.89D
2.2 12V TD	G8T 716, G8T 714, G8T 760	2.2	1996.11 - 2000.10		4446.83D
2.2 D	G8T 716	2.2	1997.11 - 2000.01		4446.83D
3.0	Z7X 775	3.0	1996.11 - 1998.10		4449.84D
<b>ESPACE IV</b>					
1.9 dCi	F9Q 820	1.9	2002.11 -		410517.89D
2.0	F4R	2.0	2002.11 -		3466.89D
2.0 dCi	M9R	2.0	2006.01 -		411475.89D ▲
2.0 Turbo (JK0B, JK0N)	F4R 796, F4R 795, F4R 794, F4R 797	2.0	2002.11 -		3466.89D
<b>FLUENCE (L30_)</b>					
1.5 dCi	K9K 830, K9K 834, K9K 836, K9K 837	1.5	2010.02 -	2 polig	411442.83D ▲

# RENAULT

	Engine	Ltr.	Year	Restriction*	Thermostat
<b>FUEGO</b>					
1.4	847 720	1.4	1980.02 - 1985.10		3029.86
1.6	A2M 723	1.6	1983.04 - 1985.10		3029.86
1.6 TS/GTS	843 723, A6M 725, A6M 726, 843 724	1.6	1980.10 - 1985.10		3029.86
1.6 Turbo	A5L 750	1.6	1983.08 - 1985.10		3029.86
2.0 TX/GTX	J6R 713, J6R 726, J6R 715, J6R 710, J6R 712, 829 710	2.0	1980.10 - 1985.10		4122.87D
2.1 TD	J8S 712	2.1	1982.08 - 1985.10		4147.80D
<b>GRAND SCÉNIC III (JZ0/1_)</b>					
1.4 16V	H4J 700	1.4	2009.02 -		411241.82D
1.5 dCi	K9K 832	1.5	2009.02 -	4 polig	411040.83D
1.5 dCi	K9K 830, K9K 836, K9K 837, K9K 636	1.5	2009.04 -	4 polig	411040.83D
1.5 dCi	K9K 830, K9K 836, K9K 837, K9K 636	1.5	2009.04 -	2 polig	411442.83D ▲
1.5 dCi	K9K 846	1.5	2010.11 -	2 polig	411442.83D ▲
2.0 16V	M4R 711	2.0	2009.02 -		411241.82D
<b>KANGOO (KC0/1_)</b>					
1.2	D7F 710, D7F 744, D7F 722, D7F 720, D7F 726, D7F 746	1.2	1997.08 - 1998.06		3174.89D
1.2	D7F 710, D7F 744, D7F 722, D7F 720, D7F 726, D7F 746	1.2	1998.07 -		3166.89D
1.2 16V	D4F 714, D4F 716, D4F 712	1.2	2001.06 -		3166.89D
1.4	E7J 634, 635, 780	1.4	1997.08 -	Deckel Thermostatgehäuse	126104 ▲
1.4	K7J 700	1.4	1997.08 -	Deckel Thermostatgehäuse	126104 ▲
1.4	K7J 700	1.4	1997.08 -		3466.89D
1.4	E7J 634, 635, 780	1.4	1997.08 -		3466.89D
1.5 dCi	K9K 702, K9K 704, K9K 700	1.5	2001.12 -		411043.89D
1.5 dCi	K9K 714, K9K 718	1.5	2005.06 -		411039.83D
1.6	K7M 746	1.6	1999.09 - 2001.06	Deckel Thermostatgehäuse	126104 ▲
1.6	K7M 746	1.6	1999.09 - 2001.06		3466.89D
1.6 16V	K4M 750, K4M 753, K4M 752	1.6	2001.06 -	Deckel Thermostatgehäuse	126104 ▲
1.6 16V	K4M 750, K4M 753, K4M 752	1.6	2001.06 -		3466.89D
1.6 Flex	K4M 730	1.6	2007.01 -	Deckel Thermostatgehäuse	126104 ▲
1.6 Flex	K4M 730	1.6	2007.01 -		3466.89D
1.9 dCi	F9Q 782	1.9	2001.10 -	Motor no. →001211	410518.89D
1.9 dCi	F9Q 782	1.9	2001.11 -	Motor no. 001211→	410517.89D
1.9 dCi	F9Q 790	1.9	2003.10 -		410517.89D
1.9 dTi	F9Q 780	1.9	2000.02 - 2000.05		410518.89D
1.9 dTi	F9Q 780	1.9	2000.06 -		3470.89D50
1.9 RXED	F8Q 632	1.9	1999.09 - 2000.05		410518.89D
1.9 RXED	F8Q 632	1.9	2000.06 - 2000.11		3470.89D50
D 55 1.9	F8Q 662	1.9	1997.08 - 1998.01		3470.89D50
D 55 1.9	F8Q 662	1.9	1998.02 - 2000.05		410530.89D
D 55 1.9	F8Q 662	1.9	2000.06 -		3470.89D50
D 65 1.9	F8Q 632, F8Q 630	1.9	1997.08 - 2000.05		410518.89D
D 65 1.9	F8Q 632, F8Q 630	1.9	2000.06 - 2000.11		3470.89D50
D 65 1.9	F8Q 632, F8Q 630	1.9	2000.11 -		410517.89D

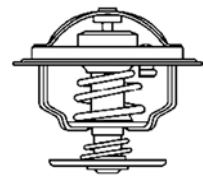

# RENAULT

	Engine	Ltr.	Year	Restriction*	Thermostat
<b>KANGOO (KW0/1_)</b>					
1.5 dCi	K9K 802, K9K 806, K9K 804, K9K 808	1.5	2008.02 -	4 polig	411040.83D
1.5 dCi	K9K 802, K9K 806, K9K 804, K9K 808	1.5	2008.02 -	2 polig	411442.83D ▲
1.5 dCi	K9K 800	1.5	2008.02 -		411477.89D ▲
1.6	K7M 750	1.6	2008.02 -	Deckel Thermostatgehäuse	126104 ▲
1.6	K7M 750	1.6	2008.02 -		3466.89D
<b>KANGOO Express (FC0/1_)</b>					
1.2	D7F	1.2	1997.08 - 1998.06		3174.89D
1.2	D7F	1.2	1998.07 -		3166.89D
1.2 16V	D4F 714, D4F 712, D4F 730	1.2	2001.10 -		3166.89D
1.2 BiFuel	D7F 710, D7F 744	1.2	1998.07 - 2001.07		3166.89D
1.4	E7J 634, K7J 701, E7J 635, E7J 780	1.4	1997.08 -	Deckel Thermostatgehäuse	126104 ▲
1.4	E7J 634, K7J 701, E7J 635, E7J 780	1.4	1997.08 -		3466.89D
1.5 dCi	K9K 702, K9K 704, K9K 700, K9K 710	1.5	2001.12 -		411043.89D
1.5 dCi	K9K 714, K9K 718	1.5	2005.06 -		411039.83D
1.6 16V	K4M 750, K4M 752	1.6	2001.10 -	Deckel Thermostatgehäuse	126104 ▲
1.6 16V	K4M 750, K4M 752	1.6	2001.10 -		3466.89D
1.6 16V bivalent	K4M 850	1.6	2005.06 -		3466.89D
1.9 D	F8Q 632	1.9	1999.09 - 2000.05		410518.89D
1.9 D	F8Q 632	1.9	2000.06 - 2000.11		3470.89D50
1.9 D	F8Q 632	1.9	2000.12 - 2003.06		411042.89D
1.9 dCi	F9Q 782	1.9	2001.10 -	Motor no. →001211	410518.89D
1.9 dCi	F9Q 782	1.9	2001.11 -	Motor no. 001211→	410517.89D
1.9 dCi	F9Q 790	1.9	2003.07 -		410517.89D
1.9 dTi	F9Q 780	1.9	2000.02 - 2000.05		410518.89D
1.9 dTi	F9Q 780	1.9	2000.06 -		3470.89D50
D 55 1.9	F8Q 662	1.9	1997.08 - 1998.01		3470.89D50
D 55 1.9	F8Q 662	1.9	1998.02 - 2000.05		410530.89D
D 55 1.9	F8Q 662	1.9	2000.06 -		3470.89D50
D 65 1.9	F8Q 632	1.9	1997.08 -		410517.89D
D 65 1.9	F8Q 630	1.9	1997.08 - 2000.05		410518.89D
D 65 1.9	F8Q 630	1.9	2000.06 - 2000.11		3470.89D50
D 65 1.9	F8Q 630	1.9	2000.11 -		410517.89D
<b>KANGOO Express (FW0/1_)</b>					
1.5 dCi	K9K 806	1.5	2008.02 -	4 polig	411040.83D
1.5 dCi	K9K 806	1.5	2008.02 -	2 polig	411442.83D ▲
1.5 dCi	K9K 800	1.5	2008.02 -		411477.89D ▲
1.5 dCi 75	K9K 800	1.5	2010.09 -		411477.89D ▲
1.5 dCi 85	K9K 802, K9K 800	1.5	2008.02 -	4 polig	411040.83D
1.5 dCi 85	K9K 802, K9K 800	1.5	2008.02 -	2 polig	411442.83D ▲
1.5 dCi 90	K9K 808	1.5	2009.06 -	4 polig	411040.83D
1.5 dCi 90	K9K 808	1.5	2009.06 -	2 polig	411442.83D ▲
1.5 dCi 110	K9K 804	1.5	2010.09 -		411477.89D ▲
1.60	K7M 750	1.6	2008.02 -		3466.89D
<b>MASCOTT</b>					
90	8140.63	2.8	1999.01 - 2001.12		4174.79D
90	8140.43	2.8	2000.01 - 2004.06		4151.76D
110	8140.43	2.8	1999.01 - 2004.06		4151.76D
130	8140.43	2.8	1999.01 - 2004.06		4151.76D

# Thermostats

## RENAULT

	Engine	Ltr.	Year	Restriction*	Thermostat
140	8140.43	2.8	2001.01 - 2004.06		4151.76D
150	8140.43	2.8	2001.10 - 2004.06		4174.79D
<b>KOLEOS (HY_)</b>					
2.0 dCi	M9R	2.0	2008.09 -		411475.89D ▲
<b>LAGUNA I (B56_, 556_)</b>					
1.6 16V	K4M 720	1.6	1997.11 - 2001.03	Deckel Thermostatgehäuse	126104 ▲
1.6 16V	K4M 720	1.6	1997.11 - 2001.03		3466.89D
1.8	F3P	1.8	1993.11 - 2001.03		3470.89D50
1.8 16V	F4P 760	1.8	1998.04 - 2001.03		3466.89D
1.9 dCi	F9Q 718	1.9	1999.09 - 2001.03		3470.89D50
1.9 dTi	F9Q 717, F9Q 716, F9Q 710	1.9	1997.10 - 2001.03		3470.89D50
2.0	F3R 722, F3R 723	2.0	1993.11 - 2001.03		3136.82D50
2.0	F3R 611, F3R 768	2.0	1995.06 - 2001.03		3470.89D50
2.0	N7Q 700, N7Q 704	2.0	1995.06 - 2001.02		4272.90D
2.0	F4R 780	2.0	1999.09 - 2001.02		3466.89D
2.0 16V	N7Q 700, N7Q 704	2.0	1995.06 - 2001.03		4272.90D
2.0 16V	F4R 780	2.0	1999.09 - 2001.03		3466.89D
2.2 D	G8T 706, G8T 752, G8T 794, G8T 790	2.2	1993.11 - 2001.03		4446.83D
2.2 dT	G8T 760	2.2	1996.03 - 2001.03		4446.83D
3.0	Z7X 765, Z7X 760	3.0	1993.11 - 2001.03		4449.84D
<b>LAGUNA I Grandtour (K56_)</b>					
1.6 16V	K4M 720	1.6	1997.11 - 2001.03	Deckel Thermostatgehäuse	126104 ▲
1.6 16V	K4M 720	1.6	1997.11 - 2001.03		3466.89D
1.8	F3P	1.8	1995.09 - 2001.03		3470.89D50
1.8 16V	F4P 760	1.8	1998.04 - 2001.03		3466.89D
1.9 dCi	F9Q 718	1.9	2000.06 - 2001.03		3470.89D50
1.9 dTi	F9Q 717, F9Q 716, F9Q 710	1.9	2000.06 - 2001.03		3470.89D50
2.0	F3R 722, F3R 723, F3R 768	2.0	1995.09 - 2001.03		3470.89D50
2.0 16V	N7Q 700, N7Q 704	2.0	1995.09 - 2001.03		4272.90D
2.0 16V	F4R 780	2.0	1999.09 - 2001.03		3466.89D
2.2 D	G8T 706, G8T 752, G8T 794, G8T 790	2.2	1995.09 - 2001.03		4446.83D
2.2 dT	G8T 760	2.2	1996.03 - 2001.03		4446.83D
3.0	Z7X 765	3.0	1996.02 - 2001.03		4449.84D
<b>LAGUNA II (BG / KG)</b>					
1.6 16V	K4M 710	1.6	2001.03 -	Deckel Thermostatgehäuse, Motor no. →030626	126104 ▲
1.6 16V	K4M 710	1.6	2001.03 -	Motor no. →030626	3466.89D
1.6 16V	K4M 714, K4M 716	1.6	2005.02 -	Deckel Thermostatgehäuse	126104 ▲
1.6 16V	K4M 714, K4M 716	1.6	2005.02 -		3466.89D
1.6 FlexFuel	K4M 718	1.6	2001.06 - 2003.10	Deckel Thermostatgehäuse	126104 ▲
1.6 FlexFuel	K4M 718	1.6	2001.06 - 2003.10		3466.89D
1.6 LPG	K4M 714	1.6	2001.03 - 2005.05	Deckel Thermostatgehäuse	126104 ▲
1.6 LPG	K4M 714	1.6	2001.03 - 2005.05		3466.89D
1.8 16V	F4P 774, F4P 773, F4P 771	1.8	2001.03 -		3466.89D

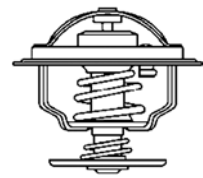

# RENAULT

	Engine	Ltr.	Year	Restriction*	Thermostat
1.8 16V	F4P 774, F4P 773, F4P 771	1.8	2001.03 -		<b>3466.89D</b>
1.8 16V	F4P 770, F4P 772, F4P 775	1.8	2001.03 -		<b>3466.89D</b>
1.9 dCi	F9Q 670, F9Q 718, F9Q 750, F9Q 754, F9Q 756	1.9	2001.03 -	Motor no. →010608	<b>3470.89D50</b>
1.9 dCi	F9Q 670, F9Q 718, F9Q 750, F9Q 754, F9Q 756	1.9	2001.04 -	Motor no. 010608→	<b>410517.89D</b>
1.9 dCi	F9Q 664, F9Q 752, F9Q 758, F9Q 759	1.9	2004.03 -		<b>410517.89D</b>
2.0	F4R 713	2.0	2002.09 - 2005.05		<b>3466.89D</b>
2.0 16V	F4R	2.0	2002.08 -		<b>3466.89D</b>
2.0 16V DIE	F5R 701, F5R 700	2.0	2001.04 -		<b>3466.89D</b>
2.0 16V Turbo	F4R 764, F4R 787, F4R 786, F4R 765	2.0	2003.01 -		<b>3466.89D</b>
2.0 dCi	M9R 740, M9R 760	2.0	2005.08 -		<b>411475.89D ▲</b>
<b>LAGUNA III (BT0 / KT0)</b>					
1.5 dCi	K9K 780	1.5	2007.10 -	4 polig	<b>411040.83D</b>
1.5 dCi	K9K 780	1.5	2007.10 -	2 polig	<b>411442.83D ▲</b>
2.0 16V	M4R 704, M4R 726	2.0	2007.10 -		<b>411241.82D</b>
2.0 16V Turbo	F4R 811	2.0	2007.10 -		<b>3466.89D</b>
2.0 dCi	M9R	2.0	2007.10 -		<b>411475.89D ▲</b>
2.0 GT	F4R 800	2.0	2008.03 -		<b>3466.89D</b>
<b>LATITUDE (L70_)</b>					
2.0 dCi		2.0	2011.02 -		<b>411475.89D ▲</b>
2.0 dCi 150	M9R 824, M9R 846	2.0	2011.02 -		<b>411475.89D ▲</b>
2.0 dCi 175	M9R 804, M9R 844, M9R 817	2.0	2011.05 -		<b>411475.89D ▲</b>
LAGUNA Coupe (DT0/1)	F4Rt 811, F4R 811	2.0	2008.09 -		<b>3466.89D</b>
2.0 16V Turbo					
2.0 dCi	M9R	2.0	2008.09 -		<b>411475.89D ▲</b>
2.0 dCi GT	M9R 820, M9R 816	2.0	2008.03 -		<b>411475.89D ▲</b>
2.0 GT	F4Rt 800	2.0	2008.09 -		<b>3466.89D</b>
<b>LOGAN (LS / KS)</b>					
1.0 Hi-Flex		1.0	2007.07 -		<b>3166.89D</b>
1.4	K7J 710	1.4	2004.09 -	Deckel Thermostatgehäuse	<b>126104 ▲</b>
1.4	K7J 710	1.4	2004.09 -		<b>3466.89D</b>
1.5 dCi	K9K 792, K9K 796	1.5	2007.04 -		<b>411039.83D</b>
1.6	K7M 710	1.6	2004.09 -	Deckel Thermostatgehäuse	<b>126104 ▲</b>
1.6	K7M 710	1.6	2004.09 -		<b>3466.89D</b>
1.6	K4M 690, K4M 697	1.6	2007.04 -	Deckel Thermostatgehäuse	<b>126104 ▲</b>
1.6	K4M 690, K4M 697	1.6	2007.04 -		<b>3466.89D</b>
<b>MASTER II</b>					
1.9 dCi 80	F9Q 772, F9Q 774	1.9	2001.11 -		<b>410517.83D</b>
1.9 dTI	F9Q 770	1.9	2000.09 -		<b>3470.89D50</b>
2.5 D	S8U 770	2.5	1998.07 - 2001.01		<b>4174.79D</b>
2.8 dTI	S9W 702	2.8	1998.07 - 2001.10		<b>4174.79D</b>
<b>MEGANE I (BA)</b>					
1.4 16V	K4J 714, K4J 750	1.4	1999.03 - 2003.08	Deckel Thermostatgehäuse	<b>126104 ▲</b>
1.4 16V	K4J 714, K4J 750	1.4	1999.03 - 2003.08		<b>3466.89D</b>

# Thermostats

## RENAULT

	Engine	Ltr.	Year	Restriction*	Thermostat
1.4 e	E7J 626, E7J 764	1.4	1996.01 - 2003.08	Deckel T hermostatgehäuse	126104 ▲
1.4 e	E7J 626, E7J 764	1.4	1996.01 - 2003.08		3466.89D
1.4 Eco	E7J 624	1.4	1996.01 - 1999.03	Deckel Thermostatgehäuse	126104 ▲
1.4 Eco	E7J 624	1.4	1996.01 - 1999.03		3466.89D
1.6	K7M 704	1.6	2000.02 - 2000.09	Deckel Thermostatgehäuse	126104 ▲
1.6	K7M 704	1.6	2000.02 - 2000.09		3466.89D
1.6 16V	K4M 708	1.6	1999.03 - 2003.08	Deckel Thermostatgehäuse	126104 ▲
1.6 16V	K4M 704, K4M 700, K4M 708, K4M 701	1.6	1999.03 - 2003.08		3466.89D
1.6 e	K7M 702, K7M 703, K7M 790	1.6	1996.01 - 1999.03	Deckel Thermostatgehäuse	126104 ▲
1.6 e	K7M 702, K7M 703, K7M 790	1.6	1996.01 - 1999.03		3466.89D
1.6 i	K7M 720	1.6	1996.01 - 1999.03	Deckel Thermostatgehäuse	126104 ▲
1.6 i	K7M 720	1.6	1996.01 - 1999.03		3466.89D
1.6 LPG	K7M 702	1.6	1995.08 - 1999.03		3466.89D
1.6 LPG	K4M 704	1.6	2000.10 - 2002.08	Deckel Thermostatgehäuse	126104 ▲
1.6 LPG	K4M 704	1.6	2000.10 - 2002.08		3466.89D
1.8 16V	F4P 722, F4P 720	1.8	2001.01 - 2003.08		3466.89D
1.9 D	F8Q 784	1.9	1996.04 - 1998.01		3470.89D50
1.9 D	F8Q 784	1.9	1998.02 - 2001.02		410530.89D
1.9 D Eco	F8Q 620, F8Q 624	1.9	1996.01 - 1998.01		3470.89D50
1.9 D Eco	F8Q 620, F8Q 624	1.9	1998.02 - 2000.05		410530.89D
1.9 D Eco	F8Q 620, F8Q 624	1.9	2000.06 - 2003.08		3470.89D50
1.9 DCi	F9Q 738	1.9	2000.05 - 2003.08		410518.89D
1.9 DCi	F9Q 738	1.9	2000.06 - 2003.08		3470.89D50
1.9 DCi	F9Q 738	1.9	2000.12 - 2003.08		410517.89D
1.9 DCi	F9Q 733	1.9	2001.02 - 2003.08		410517.89D
1.9 DCi	F9Q 732	1.9	2001.02 - 2003.08	Motor no. 001212→	410517.89D
1.9 DCi	F9Q 732	1.9	2001.02 - 2003.08	Motor no. →001210	410518.89D
1.9 dT	F8Q 786, F8Q 784	1.9	1996.01 - 1998.01		3470.89D50
1.9 dT	F8Q 786, F8Q 784	1.9	1998.02 - 2000.05		410530.89D
1.9 dT	F8Q 786, F8Q 784	1.9	2000.06 - 2003.08		3470.89D50
1.9 dTi	F9Q 731 / 736	1.9	1997.03 - 2000.05		410518.89D
1.9 dTi	F9Q 730/734	1.9	1997.03 - 2000.05		410530.89D
1.9 DTi	0	1.9	2000.02 - 2000.05		410530.89D
1.9 dTi	F9Q 731/736	1.9	2000.06 - 2000.12		3470.89D50
1.9 dTi	F9Q 730/731/734/736	1.9	2000.06 - 2001.02		3470.89D50
1.9 DTi	0	1.9	2000.06 - 2000.09		3470.89D50
1.9 dTi	F9Q 731/736	1.9	2000.12 - 2001.02		410517.89D
1.9 dTi	F9Q 744	1.9	2001.02 - 2003.08		410517.89D
1.9 TDI	F8Q 784	1.9	1996.09 - 1998.01		3470.89D50
1.9 TDI	F8Q 784	1.9	1998.02 - 2000.05		410530.89D
1.9 TDI	F8Q 784	1.9	2000.06 - 2003.08		3470.89D50
2.0 16V	F7R 710, F7R 714	2.0	1996.07 - 2003.08		3470.89D50
2.0 i	F3R 751, F3R 750	2.0	1996.01 - 1998.01		3470.89D50
2.0 i	F3R 751, F3R 750	2.0	1998.02 - 2000.05		410530.89D
2.0 i	F3R 751, F3R 750	2.0	2000.06 - 2003.08		3470.89D50

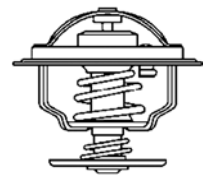

# RENAULT

	Engine	Ltr.	Year	Restriction*	Thermostat
<b>MEGANE I Cabriolet (EA)</b>					
1.4 16V	K4J 714, K4J 750	1.4	1999.03 - 2003.08	Deckel Thermostatgehäuse	<b>126104 ▲</b>
1.4 16V	K4J 714, K4J 750	1.4	1999.03 - 2003.08		<b>3466.89D</b>
1.6 16V	K4M 700, K4M 708, K4M 701	1.6	1999.03 - 2003.08	Deckel Thermostatgehäuse	<b>126104 ▲</b>
1.6 16V	K4M 700, K4M 708, K4M 701	1.6	1999.03 - 2003.08		<b>3466.89D</b>
1.6 e	K7M 702, K7M 703	1.6	1996.10 - 1999.03	Deckel Thermostatgehäuse	<b>126104 ▲</b>
1.6 e	K7M 702, K7M 703	1.6	1996.10 - 1999.03		<b>3466.89D</b>
2.0	F3R 750	2.0	1997.04 - 1998.01		<b>3470.89D50</b>
2.0	F3R 750	2.0	1998.02 - 2000.05		<b>410530.89D</b>
2.0	F3R 750	2.0	2000.06 - 2003.08		<b>3470.89D50</b>
2.0 16V	F7R 710, F7R 714	2.0	1996.10 - 1999.11		<b>3470.89D50</b>
2.0 16V	F4R 746, F4R 770	2.0	2002.01 - 2003.08		<b>3466.89D</b>
2.0 16V IDE	F5R 740	2.0	1999.11 - 2003.08		<b>3466.89D</b>
2.0 i	F3R 791, F3R 796	2.0	1999.03 - 2003.08		<b>3470.89D50</b>
<b>MEGANE I Classic (LA)</b>					
1.4	E7J 626, E7J 764	1.4	1996.09 - 2003.08	Deckel Thermostatgehäuse	<b>126104 ▲</b>
1.4	E7J 626, E7J 764	1.4	1996.09 - 2003.08		<b>3466.89D</b>
1.4 16V	K4J 714, K4J 750	1.4	1999.03 - 2003.08	Deckel Thermostatgehäuse	<b>126104 ▲</b>
1.4 16V	K4J 714, K4J 750	1.4	1999.03 - 2003.08		<b>3466.89D</b>
1.6 16V	K4M 708	1.6	1999.03 - 2003.08	Deckel Thermostatgehäuse	<b>126104 ▲</b>
1.6 16V	K4M 700, K4M 708, K4M 701	1.6	1999.03 - 2003.08		<b>3466.89D</b>
1.6 e	K7M 702, K7M 703, K7M 790	1.6	1996.09 - 1999.03	Deckel Thermostatgehäuse	<b>126104 ▲</b>
1.6 e	K7M 702, K7M 703, K7M 790	1.6	1996.09 - 1999.03		<b>3466.89D</b>
1.6 i	K7M 720	1.6	1996.09 - 1999.03	Deckel Thermostatgehäuse	<b>126104 ▲</b>
1.6 i	K7M 720	1.6	1996.09 - 1999.03		<b>3466.89D</b>
1.8 16V	F4P 722, F4P 720	1.8	2001.01 - 2003.08		<b>3466.89D</b>
1.9 D	F8Q 620, F8Q 624	1.9	1996.09 - 1998.01		<b>3470.89D50</b>
1.9 D	F8Q 620, F8Q 624	1.9	1998.02 - 2000.05		<b>410530.89D</b>
1.9 D	F8Q 620, F8Q 624	1.9	2000.06 - 2003.08		<b>3470.89D50</b>
1.9 dCi	F9Q 732	1.9	2001.02 - 2003.08	Motor no. 001211→	<b>410517.89D</b>
1.9 dCi	F9Q 733, F9Q 738	1.9	2001.02 - 2003.08		<b>410517.89D</b>
1.9 dCi	F9Q 732	1.9	2001.02 - 2003.08	Motor no. →001210	<b>410518.89D</b>
1.9 dT	F8Q 786, F8Q 784	1.9	1996.09 - 1998.01		<b>3470.89D50</b>
1.9 dT	F8Q 786, F8Q 784	1.9	1998.02 - 2000.05		<b>410530.89D</b>
1.9 dT	F8Q 786, F8Q 784	1.9	2000.06 - 2003.08		<b>3470.89D50</b>
1.9 dTi	F9Q 731 / 736	1.9	1997.03 - 2000.12		<b>3470.89D50</b>
1.9 dTi	F9Q 731 / 736	1.9	1997.03 - 2000.05		<b>410518.89D</b>
1.9 dTi	F9Q 730 / 734	1.9	1997.03 - 2000.05		<b>410530.89D</b>
1.9 dTi	F9Q 730 / 731 / 734 / 736	1.9	2000.06 - 2001.02		<b>3470.89D50</b>
1.9 dTi	F9Q 731 / 736	1.9	2000.12 - 2001.02		<b>410517.89D</b>
1.9 dTi	F9Q 744	1.9	2001.02 - 2003.08		<b>410517.89D</b>
1.9 TDI	F8Q 784	1.9	1996.09 - 1998.01		<b>3470.89D50</b>
1.9 TDI	F8Q 784	1.9	1998.02 - 2000.05		<b>410530.89D</b>
1.9 TDI	F8Q 784	1.9	2000.06 - 2003.08		<b>3470.89D50</b>
2.0 i	F3R 791, F3R 751, F3R 797, F3R 798, F3R 796, F3R 752, F3R 750	2.0	1996.09 - 2003.08		<b>3470.89D50</b>



# Thermostats

## RENAULT

	Engine	Ltr.	Year	Restriction*	Thermostat
<b>MEGANE I Coach (DA0/1_)</b>					
1.4 16V	K4J 714, K4J 750	1.4	1999.03 - 2003.08	Deckel Thermostatgehäuse	126104 ▲
1.4 16V	K4J 714, K4J 750	1.4	1999.03 - 2003.08		3466.89D
1.6 16V	K4M 700, K4M 708, K4M 701	1.6	1999.03 - 2003.08	Deckel Thermostatgehäuse	126104 ▲
1.6 16V	K4M 700, K4M 708, K4M 701	1.6	1999.03 - 2003.08		3466.89D
1.6 e	K7M 702, K7M 703	1.6	1996.03 - 1999.03	Deckel Thermostatgehäuse	126104 ▲
1.6 e	K7M 702, K7M 703	1.6	1996.03 - 1999.03		3466.89D
1.9 dCi	F9Q 732, F9Q 733	1.9	2001.02 - 2003.08		3470.89D50
1.9 dCi	F9Q 732, F9Q 733	1.9	2001.02 - 2003.08		410517.89D
1.9 dCi	F9Q 732, F9Q 733	1.9	2001.02 - 2003.08		410518.89D
1.9 dTi	F9Q 731 / 736	1.9	1997.03 - 2000.12		3470.89D50
1.9 dTi	F9Q 731 / 736	1.9	1997.03 - 2000.05		410518.89D
1.9 dTi	F9Q 734	1.9	1997.03 - 2000.05		410530.89D
1.9 dTi	F9Q 731 / 734 / 736	1.9	2000.06 - 2001.02		3470.89D50
1.9 dTi	F9Q 731 / 736	1.9	2000.12 - 2001.02		410517.89D
2.0 16V	F4R 746	2.0	2002.01 - 2003.08		3466.89D
2.0 16V (DA0H)	F7R 710, F7R 714	2.0	1996.03 - 1999.11		3470.89D50
2.0 16V DIE	F5R 740	2.0	1999.11 - 2003.08		3466.89D
2.0 i	F3R 791, F3R 796	2.0	1999.03 - 2003.08		3470.89D50
2.0 i (DA0G)	F3R 751, F3R 750	2.0	1998.01 - 2003.08		3470.89D50
2.0 i (DA0G)	F3R 751, F3R 750	2.0	1998.02 - 2000.05		410530.89D
2.0 i (DA0G)	F3R 751, F3R 750	2.0	2000.06 - 2003.08		3470.89D50
<b>MEGANE I Grandtour (KA0/1_)</b>					
1.4 16V	K4J 714, K4J 750	1.4	1999.03 - 2003.08	Deckel Thermostatgehäuse	126104 ▲
1.4 16V	K4J 714, K4J 750	1.4	1999.03 - 2003.08		3466.89D
1.4 e	E7J 626	1.4	1999.03 - 2003.08	Deckel Thermostatgehäuse	126104 ▲
1.4 e	E7J 626	1.4	1999.03 - 2003.08		3466.89D
1.6 16V	K4M 708	1.6	1999.03 - 2003.08	Deckel Thermostatgehäuse	126104 ▲
1.6 16V	K4M 704, K4M 700, K4M 708, K4M 701	1.6	1999.03 - 2003.08		3466.89D
1.6 e	K7M 702, K7M 703	1.6	1999.03 - 2003.08	Deckel Thermostatgehäuse	126104 ▲
1.6 e	K7M 702, K7M 703	1.6	1999.03 - 2003.08		3466.89D
1.8 16V	F4P 722, F4P 720	1.8	2001.01 - 2003.08		3466.89D
1.9 D	F8Q 622	1.9	1999.04 - 2000.05		410518.89D
1.9 D	F8Q 790	1.9	2000.05 - 2003.08		410530.89D
1.9 D	F8Q 622, F8Q 790	1.9	2000.06 - 2003.08		3470.89D50
1.9 dCi	F9Q 738	1.9	2001.02 - 2003.08		3470.89D50
1.9 dCi	F9Q 732	1.9	2001.02 - 2003.08		410517.89D
1.9 dCi	F9Q 738	1.9	2001.02 - 2003.08		410518.89D
1.9 dTi (KA0N)	F9Q 731, F9Q 736	1.9	1999.03 - 2000.05		410518.89D
1.9 dTi (KA0N)	F9Q 731, F9Q 736	1.9	2000.06 - 2001.02		3470.89D50
1.9 dTi (KA1U)	F9Q 744	1.9	2001.02 - 2003.08		410517.89D

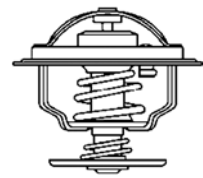

# RENAULT

	Engine	Ltr.	Year	Restriction*	Thermostat
<b>MEGANE II (BM, CM)</b>					
1.4 16V	K4J 740	1.4	2002.11 -	Deckel Thermostatgehäuse	<b>126104 ▲</b>
1.4 16V	K4J 740	1.4	2002.11 -		<b>3466.89D</b>
1.4 16V	K4J 730, K4J 732	1.4	2003.10 -	Deckel Thermostatgehäuse, Motor no. →050117	<b>126104 ▲</b>
1.4 16V	K4J 730, K4J 732	1.4	2003.10 -	Motor no. →050117	<b>3466.89D</b>
1.5 dCi	K9K 722	1.5	2002.11 -		<b>411477.89D ▲</b>
1.5 dCi	K9K 724, K9K 729, K9K 732, K9K 734	1.5	2003.10 -	4 polig	<b>411040.83D</b>
1.5 dCi	K9K 728	1.5	2003.10 -		<b>411042.89D</b>
1.6	K4M 788	1.6	2005.06 -		<b>3466.89D</b>
1.6 16V	K4M 760	1.6	2002.11 -	Deckel Thermostatgehäuse, Motor no. →050117	<b>126104 ▲</b>
1.6 16V	K4M 760	1.6	2002.11 -	Motor no. →050117	<b>3466.89D</b>
1.6 Flex-Fuel	K4M 788	1.6	2007.01 -		<b>3466.89D</b>
1.9 dCi	F9Q 800	1.9	2002.11 -		<b>410538.89D</b>
1.9 dCi	F9Q 803, F9Q 804, F9Q 816, F9Q 818	1.9	2002.11 - 2006.09		<b>410538.89D</b>
2.0	F4R 774	2.0	2006.08 -		<b>3466.89D</b>
2.0 16V	F4R 770	2.0	2002.11 -		<b>3466.89D</b>
2.0 16V Turbo	F4R 776	2.0	2004.05 -		<b>3466.89D</b>
2.0 dCi	M9R 722, M9R 700, M9R 724	2.0	2005.09 -		<b>411475.89D ▲</b>
2.0 Renault Sport	F4R 774, F4Rt 774	2.0	2004.05 -		<b>3466.89D</b>
<b>MEGANE II (EM)</b>					
1.5 dCi	K9K 732	1.5	2006.03 -	4 polig	<b>411040.83D</b>
1.5 dCi	K9K 732	1.5	2006.03 -	2 polig	<b>411442.83D ▲</b>
1.5 dCi	K9K 734	1.5	2007.01 -	4 polig	<b>411040.83D</b>
1.5 dCi	K9K 734	1.5	2007.01 -	2 polig	<b>411442.83D ▲</b>
1.6	K4M 760, K4M 761	1.6	2003.09 -	Deckel Thermostatgehäuse, Motor no. →050117	<b>126104 ▲</b>
1.6	K4M 760, K4M 761	1.6	2003.09 -	Motor no. →050117	<b>3466.89D</b>
1.9 dCi	F9Q 803	1.9	2003.09 - 2006.09		<b>410538.89D</b>
1.9 dCi	F9Q 800	1.9	2003.09 -		<b>410538.89D</b>
2.0	F4R 770	2.0	2003.09 - 2007.02		<b>3466.89D</b>
2.0 16V Turbo	F4R 776	2.0	2004.05 -		<b>3466.89D</b>
2.0 dCi	M9R 722, M9R 700	2.0	2005.09 -		<b>411475.89D ▲</b>
<b>MEGANE II Grandtour (KM0/1_)</b>					
1.4	K4J 740	1.4	2003.08 -	Deckel Thermostatgehäuse	<b>126104 ▲</b>
1.4	K4J 730	1.4	2003.08 -	Deckel Thermostatgehäuse, Motor no. →050117	<b>126104 ▲</b>
1.4	K4J 740	1.4	2003.08 -		<b>3466.89D</b>
1.4	K4J 730	1.4	2003.08 -	Motor no. →050117	<b>3466.89D</b>
1.5 dCi	K9K 722	1.5	2003.08 -		<b>411477.89D ▲</b>
1.5 dCi	K9K 724, K9K 729, K9K 732, K9K 734	1.5	2004.02 -	4 polig	<b>411040.83D</b>
1.5 dCi	K9K 728	1.5	2004.02 -		<b>411042.89D</b>
1.6	K4M 760, K4M 761	1.6	2005.01 -	Deckel Thermostatgehäuse	<b>126104 ▲</b>
1.6	K4M 760, K4M 761	1.6	2005.01 -		<b>3466.89D</b>
1.6 16V Hi-Flex	K4M 762	1.6	2008.02 -		<b>3466.89D</b>
1.9 dCi	F9Q 800	1.9	2003.08 -		<b>410538.89D</b>

# Thermostats

## RENAULT

	Engine	Ltr.	Year	Restriction*	Thermostat
1.9 dCi	F9Q 803, F9Q 804, F9Q 808, F9Q 818	1.9	2005.05 - 2006.09		410538.89D
2.0	F4R 770	2.0	2003.08 -		3466.89D
2.0 dCi	M9R 722, M9R 700	2.0	2005.09 -		411475.89D ▲
<b>MEGANE II Stufenheck (LM)</b>					
1.4	K4J 740, K4J 730	1.4	2003.09 -	Deckel Thermostatgehäuse, Motor no. →050117	126104 ▲
1.4	K4J 732	1.4	2003.09 - 2005.01		3466.89D
1.4	K4J 740, K4J 730	1.4	2003.09 -	Motor no. →050117	3466.89D
1.5 dCi	K9K 722	1.5	2003.09 -		411477.89D ▲
1.5 dCi	K9K 724, K9K 729, K9K 732, K9K 734	1.5	2004.02 -	4 polig	411040.83D
1.5 dCi	K9K 729	1.5	2004.02 -		411042.89D
1.6	K4M 760, K4M 761	1.6	2003.09 -	Deckel Thermostatgehäuse, Motor no. →050117	126104 ▲
1.6	K4M 760, K4M 761	1.6	2003.09 -	Motor no. →050117	3466.89D
1.6	K4M 762, K4M 768	1.6	2003.09 -		3466.89D
1.9 dCi	F9Q 800	1.9	2003.09 -		410538.89D
1.9 dCi	F9Q 803	1.9	2005.05 - 2006.09		410538.89D
2.0	F4R 770	2.0	2003.09 -		3466.89D
2.0 dCi	M9R 722, M9R 700	2.0	2005.09 -		411475.89D ▲
<b>MEGANE Scenic (JA0/1)</b>					
1.4 i	E7J 764	1.4	1997.01 - 1999.09	Deckel Thermostatgehäuse	126104 ▲
1.4 i	E7J 764	1.4	1997.01 - 1999.09		3466.89D
1.6 16V	K4M 704, K4M 700, K4M 708, K4M 701	1.6	1998.04 - 1999.10	Deckel Thermostatgehäuse	126104 ▲
1.6 16V	K4M 704, K4M 700, K4M 708, K4M 701	1.6	1998.04 - 1999.10		3466.89D
1.6 e	K7M 702, K7M 703	1.6	1996.10 - 1999.10	Deckel Thermostatgehäuse	126104 ▲
1.6 e	K7M 702, K7M 703	1.6	1996.10 - 1999.10		3466.89D
1.6 i	K7M 720	1.6	1997.01 - 1999.09	Deckel Thermostatgehäuse	126104 ▲
1.6 i	K7M 720	1.6	1997.01 - 1999.09		3466.89D
1.9 D	F8Q 790	1.9	1997.03 - 1999.09		3470.89D50
1.9 D	F8Q 790	1.9	1997.03 - 1999.09		410518.89D
1.9 dT	F8Q 786, F8Q 784	1.9	1997.01 - 1998.01		3470.89D50
1.9 dT	F8Q 786, F8Q 784	1.9	1998.02 - 1999.09		410530.89D
1.9 dTi	F9Q 730, F9Q 734	1.9	1997.04 - 1998.01		3470.89D50
1.9 dTi	F9Q 730, F9Q 734	1.9	1998.02 - 1999.09		410530.89D
2.0 i	F3R 751, F3R 750, F3R 796	2.0	1997.01 - 1999.09		3470.89D50
2.0 RXE	F3R 750	2.0	1997.05 - 1999.10		3470.89D50
<b>MEGANE III (BZ0_), (DZ0/1_), (KZ0/1)</b>					
1.4 TCe	H4J 700	1.4	2009.04 -		411241.82D
1.5 dCi	K9K	1.5	2008.11 -	4 polig	411040.83D
1.5 dCi	K9K	1.5	2008.11 -	2 polig	411442.83D ▲
1.5 dCi	K9K 836, K9K 846	1.5	2009.02 -		411477.89D ▲
1.5 dCi	K9K 834	1.5	2009.05 -	2 polig	411442.83D ▲
2.0 CVT	M4R	2.0	2009.05 -		411241.82D
<b>MESSENGER</b>					
B 110	8140.23.2565	2.8	1996.09 - 1999.06		4151.76D

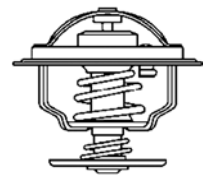

# RENAULT

	Engine	Ltr.	Year	Restriction*	Thermostat
B 110	8140.23.2565	2.8	1996.09 - 1999.06		<b>4174.79D</b>
B 120	8140.43.2585, 8140.47.2530 IDR, 8140.47.2585	2.8	1991.10 - 1999.06		<b>4151.76D</b>
B 120	8140.43.2585, 8140.47.2530 IDR, 8140.47.2585	2.8	1991.10 - 1999.06		<b>4174.79D</b>
B 80	8140.07.2530 ID, 8140.07.2585, 8140.67.2585	2.5	1990.09 - 1999.06		<b>4174.79D</b>
<b>MODUS (F/JP0)</b>					
1.2	D4F 740	1.2	2004.12 -		<b>3166.89D</b>
1.2 16V	D4F 740, D4F 784	1.2	2007.05 -		<b>3166.89D</b>
1.5 dCi	K9K 750, K9K 752	1.5	2004.09 -		<b>411477.89D ▲</b>
1.5 dCi	K9K 764, K9K 766, K9K 768	1.5	2004.12 -	4 polig	<b>411040.83D</b>
1.5 dCi	K9K 760	1.5	2004.12 -		<b>411042.89D</b>
1.5 dCi	K9K 764, K9K 766, K9K 768	1.5	2004.12 -	2 polig	<b>411442.83D ▲</b>
1.5 dCi	K9K 772	1.5	2007.05 - 2010.10		<b>411042.89D</b>
1.5 dCi	K9K 772	1.5	2011.11 -		<b>411481.89D ▲</b>
1.5 dCi 75	K9K 770	1.5	2010.10 -	2 polig	<b>411442.83D ▲</b>
1.5 dCi 90	K9K 750	1.5	2010.10 -		<b>411477.89D ▲</b>
<b>RAPID Kasten (F40, G40)</b>					
1.0	C1C 706	1.0	1986.02 - 1992.05		<b>3029.89</b>
1.1	C1E	1.1	1985.07 - 1995.04		<b>3029.89</b>
1.2	C1G 726	1.2	1991.09 - 1993.08		<b>3029.86</b>
1.2	C3G 712, C3G 710	1.2	1991.09 - 1998.03		<b>3029.89</b>
1.4	C1J, C2J, C3J	1.4	1985.07 - 1998.08		<b>3029.89</b>
1.4	E7J	1.4	1991.09 - 1998.03		<b>3469.91D</b>
1.6 D	F8M	1.6	1986.03 - 1998.08		<b>3470.89D50</b>
1.9 D	F8Q	1.9	1991.09 - 1998.03		<b>3470.89D50</b>
<b>SAFRANE I</b>					
2.5 dT	S8U 763, S8U 762	2.5	1992.12 - 1996.07		<b>3116.82D</b>
3.0 Biturbo	Z7X 726	3.0	1993.02 - 1996.07		<b>4449.84D</b>
3.0 V6	Z7X 721, Z7X 723, Z7X 753, Z7X 722	3.0	1992.12 - 1996.07		<b>4449.84D</b>
<b>SAFRANE II</b>					
2.0 16V	N7Q 710, N7Q 711	2.0	1996.07 - 2000.12		<b>4272.90D</b>
2.2 dT	G8T 740	2.2	1996.07 - 2000.12		<b>4446.83D</b>
2.5 20V	N7U 700, N7U 701	2.5	1996.07 - 2000.12		<b>4272.90D</b>
3.0 V6	Z7X 755	3.0	1996.07 - 2000.12		<b>4449.84D</b>
<b>SCÉNIC I (JA)</b>					
1.4 16V	K4J 714, K4J 750	1.4	1999.09 - 2003.08	Deckel Thermostatgehäuse	<b>126104 ▲</b>
1.4 16V	K4J 714, K4J 750	1.4	1999.09 - 2003.08		<b>3466.89D</b>
1.6	K4M	1.6	1999.09 - 2003.09	Deckel Thermostatgehäuse	<b>126104 ▲</b>
1.6	K4M	1.6	1999.09 - 2003.09		<b>3466.89D</b>
1.8	F4P 722	1.8	2000.07 - 2001.04		<b>3466.89D</b>
1.8 16V	F4P 722, F4P 720	1.8	2001.01 - 2003.08		<b>3466.89D</b>
1.9 D	F8Q 790	1.9	1999.09 - 2000.05		<b>410530.89D</b>
1.9 D	F8Q 790	1.9	2000.06 - 2001.03		<b>3470.89D50</b>
1.9 dCi	F9Q 733	1.9	1999.09 - 2003.08		<b>410517.89D</b>
1.9 dCi	F9Q 732	1.9	1999.09 - 2000.05		<b>410518.89D</b>
1.9 dCi	F9Q 732	1.9	2000.06 - 2000.12		<b>3470.89D50</b>
1.9 dCi	F9Q 740	1.9	2000.11 - 2003.08		<b>410517.89D</b>

# RENAULT

	Engine	Ltr.	Year	Restriction*	Thermostat
1.9 dCi	F9Q 732	1.9	2000.12 - 2003.08		410517.89D
1.9 dTi	F9Q 731, F9Q 736	1.9	1999.09 - 2000.12		3470.89D50
1.9 dTi	F9Q 731, F9Q 736	1.9	1999.09 - 2000.12		410517.89D
1.9 dTi	F9Q 731, F9Q 736	1.9	1999.09 - 2000.05		410518.89D
1.9 dTi	F9Q 734	1.9	1999.09 - 2000.05		410530.89D
1.9 dTi	F9Q 734, F9Q 731, F9Q 736	1.9	2000.06 -		3470.89D50
1.9 dTi	F9Q 731, F9Q 736	1.9	2000.12 -		410517.89D
1.9 dTi	F9Q 744	1.9	2001.02 - 2003.08		410517.89D
2.0 16V	F4R 741, F4R 740, F4R 744	2.0	1999.09 - 2003.08		3466.89D
2.0 16V	F4R 741, F4R 740, F4R 746	2.0	2000.07 - 2003.08		3466.89D
2.0 16V RX4	F4R 746, F4R 744	2.0	2000.06 - 2003.08		3466.89D
<b>SCÉNIC II (JM)</b>					
1.4	K4J 730	1.4	2003.06 -	Deckel Thermostatgehäuse, Motor no. →050117	126104 ▲
1.4	K4J 740, K4J 770	1.4	2003.06 -	Deckel Thermostatgehäuse	126104 ▲
1.4	K4J 730	1.4	2003.06 -	Motor no. →050117	3466.89D
1.4	K4J 740, K4J 770	1.4	2003.06 -		3466.89D
1.5 dCi	K9K 722	1.5	2003.06 -		411477.89D ▲
1.5 dCi	K9K 724, K9K 729, K9K 732, K9K 734	1.5	2003.11 -	4 polig	411040.83D
1.5 dCi	K9K 728	1.5	2003.11 -		411042.89D
1.6	K4M 761, K4M 782	1.6	2003.06 -	Deckel Thermostatgehäuse, Motor no. →050117	126104 ▲
1.6	K4M 761, K4M 782	1.6	2003.06 -	Motor no. →050117	3466.89D
1.6	K4M 788	1.6	2006.06 -		3466.89D
1.9 D	F9Q J 803, F9Q 812	1.9	2006.06 -		410538.89D
1.9 dCi	F9Q 812	1.9	2003.06 -		410538.89D
1.9 dCi	F9Q 804	1.9	2005.05 -		410538.89D
2.0	F4R 770	2.0	2003.06 -		3466.89D
2.0 16V Turbo	F4R 776	2.0	2004.05 -		3466.89D
2.0 dCi	M9R 721, M9R 722, M9R 700	2.0	2005.09 -		411475.89D ▲
<b>SCÉNIC III (JZ)</b>					
1.4 16V	H4J 700	1.4	2009.02 -		411241.82D
1.5 dCi	K9K 636, K9K 830, K9K 832, K9K 836, K9K 837	1.5	2009.02 -	4 polig	411040.83D
1.5 dCi	K9K 636, K9K 830, K9K 832, K9K 836, K9K 837	1.5	2009.02 -	2 polig	411442.83D ▲
1.5 dCi	K9K 846	1.5	2010.11 -	2 polig	411442.83D ▲
2.0 16V	M4R 711, M4R 710	2.0	2009.02 -		411241.82D
<b>GRAND SCÉNIC</b>					
1.5 dCi	K9K 728	1.5	2004.04 -		411042.89D
1.6	K4M 761, K4M 782	1.6	2004.04 -	Deckel Thermostatgehäuse, Motor no. →050117	126104 ▲
1.6	K4M 761, K4M 782	1.6	2004.04 -	Motor no. →050117	3466.89D
1.6	K4M 788	1.6	2006.06 -		3466.89D
1.9 dCi	F9Q E 804, F9Q 812	1.9	2004.04 -		410538.89D
2.0	F4R 770, F4R 776	2.0	2004.04 -		3466.89D
2.0 dCi	M9R 721, M9R 722, M9R 700	2.0	2005.09 -		411475.89D ▲

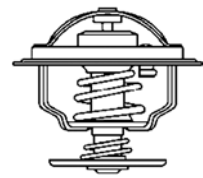

# RENAULT

	Engine	Ltr.	Year	Restriction*	Thermostat
<b>SPORT SPIDER</b>					
2.0	F7R 710	2.0	1995.12 - 1996.08		<b>3470.89D50</b>
2.0 16V	F7R 710	2.0	1995.03 - 1999.10		<b>3470.89D50</b>
<b>THALIA I (LB0/1/2_)</b>					
1.2 16V	D4F 712	1.2	2002.04 -		<b>3166.89D</b>
1.4	K7J 700	1.4	2000.08 -	Deckel Thermostatgehäuse	<b>126104 ▲</b>
1.4	K7J 700	1.4	2000.08 -		<b>3466.89D</b>
1.4 16V	K4J 712	1.4	2000.08 -	Deckel Thermostatgehäuse	<b>126104 ▲</b>
1.4 16V	K4J 712	1.4	2000.08 -		<b>3466.89D</b>
1.5 dCi	K9K 700, K9K 702	1.5	2001.06 -		<b>411043.89D</b>
1.5 dCi	K9K 740	1.5	2005.06 -		<b>411039.83D</b>
1.6 16V	K4M 740	1.6	2002.04 -	Deckel Thermostatgehäuse	<b>126104 ▲</b>
1.6 16V	K4M 740	1.6	2002.04 -		<b>3466.89D</b>
1.6 Flex	K4M 743	1.6	2004.11 - 2009.02	Deckel Thermostatgehäuse	<b>126104 ▲</b>
1.6 Flex	K4M 743	1.6	2004.11 - 2009.02		<b>3466.89D</b>
1.9 D	F8Q 630	1.9	1998.02 - 2000.05		<b>410530.89D</b>
1.9 D	F8Q 630	1.9	2000.06 - 2001.05		<b>3470.89D50</b>
<b>THALIA II (LU1/2_)</b>					
1.2 16V	D4F 728	1.2	2008.09 -		<b>3166.89D</b>
1.5 dCi	K9K 718, K9K 740	1.5	2008.09 -		<b>411039.83D</b>
1.5 dCi	K9K 700	1.5	2009.01 -		<b>411043.89D</b>
1.6 16V	K4M 744	1.6	2009.01 -	Deckel Thermostatgehäuse, Motor no. →011212	<b>126104 ▲</b>
1.6 16V	K4M 745	1.6	2009.01 -	Deckel Thermostatgehäuse	<b>126104 ▲</b>
1.6 16V	K4M 744	1.6	2009.01 -	Motor no. →011212	<b>3466.89D</b>
1.6 16V	K4M 745	1.6	2009.01 -		<b>3466.89D</b>
<b>TRAFIC (P6, T1, T3, T4, T5, T6, T7)</b>					
1.4	847 701, 847 700, C1J 700	1.4	1980.03 - 1989.04		<b>3029.86</b>
1.6	A1M 705, A1M 707, A1M 708, 841 705	1.6	1983.01 - 1986.06		<b>3053.85</b>
1.7	F1N 722, F1N 724	1.7	1986.06 - 1989.04		<b>3029.86</b>
2.0	J5R 722, J5R 716, J5R 726, 829 721, 829 720	2.0	1980.03 - 1989.04		<b>4122.87D</b>
2.1 D	852 720, 852 750	2.1	1980.03 - 1989.04		<b>4147.80D</b>
2.5 D	8140.61.240, S8U 722, S8U 720	2.5	1980.03 - 1989.04		<b>4008.79D</b>
<b>TRAFIC (PX, TX)</b>					
1.4	C1J 700	1.4	1989.05 - 1991.06		<b>3029.86</b>
1.7	F1N 720, F1N 722, F1N 724	1.7	1989.03 - 1994.08		<b>3470.89D50</b>
1.9 D	F8Q 606	1.9	1997.06 - 1998.01		<b>3470.89D50</b>
1.9 D	F8Q 606	1.9	1998.02 - 2000.05		<b>410530.89D</b>
1.9 D	F8Q 606	1.9	2000.06 - 2001.03		<b>3470.89D50</b>
2.0	J5R 716, J5R 726	2.0	1989.05 - 1997.10		<b>4122.87D</b>
2.1 D	852 750, 852 720, J8S 758, J8S 620	2.1	1989.05 - 1994.06		<b>4147.80D</b>
2.2	J7T 600, J7T 780	2.2	1989.05 - 1997.10		<b>4122.87D</b>
2.5 D	8140.61	2.5	1989.05 - 2001.03		<b>4151.76D</b>
2.5 D	8140.67	2.5	1989.05 - 2001.03		<b>4174.79D</b>

# Thermostats

## RENAULT

	Engine	Ltr.	Year	Restriction*	Thermostat
2.5 D	S8U720, S8U722	2.5	1989.05 - 2001.03		4174.79D
2.5 D	S8U 780, S8U 758	2.5	1994.09 - 2001.03		4151.76D
<b>TRAFIC (FL, JL, EL)</b>					
1.9 dCi	F9Q 762	1.9	2001.04 - 2003.07		410517.83D
1.9 dCi 80	F9Q 760, F9Q 762	1.9	2001.03 -		410517.83D
1.9 dCi 100	F9Q 760	1.9	2001.03 -		410517.83D
2.0	F4R 722, F4R 720	2.0	2001.03 -		3466.89D
2.0 16V	F4R 820	2.0	2006.08 -		3466.89D
2.0 dCi 90	M9R 782, M9R 780	2.0	2006.08 -		411476.83D ▲
2.0 dCi 115	M9R	2.0	2006.08 -		411476.83D ▲
<b>TWINGO I (C06_)</b>					
1.2	C3G 702, C3G 700	1.2	1993.03 - 1996.10		3029.89
1.2	D7F	1.2	1996.05 - 1998.06		3174.89D
1.2	D7F	1.2	1998.07 -		3166.89D
1.2 16V	D4F 702, D4F 708	1.2	2001.01 -		3166.89D
1.2 LPG	D7F 708, D7F 702	1.2	2003.10 -		3166.89D
<b>TWINGO II (CNO_)</b>					
1.2	D7F 800	1.2	2007.03 -		3166.89D
1.2 16V	D4F 764, D4F 772	1.2	2007.03 -		3166.89D
1.2 TCe 100	D4F 780, D4F 782	1.2	2011.02 -		3166.89D
1.2 Turbo	D4F 780, D4F 782	1.2	2007.03 -		3166.89D
1.5 dCi	K9K 718, K9K 740	1.5	2007.03 -	4 polig	411040.83D
1.5 dCi	K9K 718, K9K 740	1.5	2007.03 -	2 polig	411442.83D ▲
1.5 dCi 75	K9K 820	1.5	2010.10 -	2 polig	411442.83D ▲
1.5 dCi 90	K9K 820, K9K 830	1.5	2010.10 -	2 polig	411442.83D ▲
<b>TWINGO I Kasten (S06_)</b>					
1.2	C3G 702, C3G 700	1.2	1993.03 - 1996.05		3029.86
1.2	D7F 700, D7F 702, D7F 704, D7F 706, D7F 701, D7F 703	1.2	1996.05 - 1998.06		3174.89D
1.2	D7F 700, D7F 702, D7F 704, D7F 706, D7F 701, D7F 703	1.2	1998.07 -		3166.89D
<b>VEL SATIS (BJ0)</b>					
2.0 16V Turbo	F4R 762, F4R 763, F4R 766, F4R 767	2.0	2002.06 -		3466.89D
2.0 dCi	M9R 762, M9R 763, M9R 760	2.0	2005.08 -		411475.89D ▲
2.0 Turbo	F4R 867	2.0	2005.04 -		3466.89D
<b>WIND (E4M_)</b>					
1.2	D4F 782	1.2	2010.07 -		3166.89D
1.2 TCe 100	D4F 780	1.2	2011.02 -		3166.89D

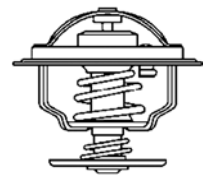

# ROLLS-ROYCE

	Engine	Ltr.	Year	Restriction*	Thermostat
<b>GHOST</b>					
6.6 V12	N74 B66 A	6.6	2008.08 -		4508.105D
<b>PHANTOM</b>					
6.75	N73 B68 A	6.75	2002.08 -		4508.105D
<b>PHANTOM Coupe</b>					
6.75 V12	N73 B68 A	6.75	2007.01 -		4508.105D
<b>PHANTOM DROPHEAD COUPE</b>					
6.75 V12	N73 B68 A	6.75	2006.03 -		4508.105D
<b>WRAITH Coupe</b>					
6.6 V12		6.6	2013.07 -		4508.105D



# Thermostats

## ROVER

	Engine	Ltr.	Year	Restriction*	Thermostat
<b>25 (RF)</b>					
1.4 16V	14 K4F	1.4	1999.10 - 2005.05		410808.88D
1.6 16V	16 K4F	1.6	1999.10 - 2005.05		410808.88D
1.8 16V	18 K4F, 18 K4K	1.8	1999.10 - 2005.05		410808.88D
<b>45 (RT)</b>					
1.4	14 K4F	1.4	2000.02 - 2005.05		410808.88D
1.6	16 K4F	1.6	2000.02 - 2005.05		410808.88D
1.8	18 K4F	1.8	2000.02 - 2005.05		410808.88D
2.0 V6	20 K4F	2.0	2000.02 - 2005.05		410808.88D
<b>75 (RJ)</b>					
1.8	K 1.8	1.8	1999.02 - 2005.05		410808.88D
1.8 Turbo	18 K4G	1.8	2003.05 - 2005.05		410806.88D
2.0 V6	20 K4F	2.0	1999.02 - 2005.05		410808.88D
<b>100 Cabriolet (XP)</b>					
111	11 K2D	1.1	1994.04 - 1997.10		410808.88D
114	14 K2D, 14 K2A, 14 K4F	1.4	1994.04 - 1998.10		410808.88D
<b>100 / METRO (XP)</b>					
111	11 K2D, 11 K2A	1.1	1990.03 - 1998.12		410808.88D
114	14 K2D, 14 K2A, 14 K4F	1.4	1990.03 - 1998.12		410808.88D
114 D	TUD 3	1.4	1992.10 - 1994.12		4821.89D
114 GTI 16V	14 K4C, 14 K4D, 14 K4F	1.4	1990.03 - 1998.12		410808.88D
114 GTI/GT 16V KAT	14 K4C, 14 K4D	1.4	1990.03 - 1998.12		410808.88D
115 D	TUD 5	1.5	1994.12 - 1998.12		4821.89D
<b>200 (XH)</b>					
213 S	EV 2	1.3	1985.09 - 1989.09		4269.78D
<b>200 (RF)</b>					
1.4	14 K4D	1.4	1996.01 - 1997.12		410808.88D
211	11 K2D	1.1	1998.01 - 2000.03		410808.88D
214 i	14 K2F	1.4	1995.11 - 2000.03		410808.88D
214 Si	14 K4F	1.4	1995.11 - 2000.03		410808.88D
216 Si	16 K4F	1.6	1995.11 - 2000.03		410808.88D
218 K Vi	18 K4K	1.8	1995.11 - 2000.03		410808.88D
<b>200 (XW)</b>					
214	14 K2D, 14 K2A	1.4	1993.09 - 1995.10		410808.88D
214 GSi/Si	14 K4C, 14 K4F	1.4	1990.01 - 1995.10		410808.88D
214 Si/Gsi	14 K4C, 14 K4D	1.4	1989.10 - 1995.10		410808.88D
216	D 16 A7, D 16 A8, D 16 Z2	1.6	1992.10 - 1999.06		4269.78D
216 GTi	D 16 A8	1.6	1992.10 - 1995.10		410224.82D
216 GTi	D 16 A9	1.6	1992.10 - 1995.10		410224.82D
218 TD	XUD 7TE	1.8	1991.09 - 1995.10		4147.80D
<b>400 (RT, XW)</b>					
1.6 i	D 16 A8, D 16 Z2	1.6	1994.05 - 1996.02		410224.82D
1.8 i	18 K4K	1.8	1996.06 - 1998.11		410808.88D
1.8 TD	XUD 7TE	1.8	1993.09 - 1998.11		4147.80D

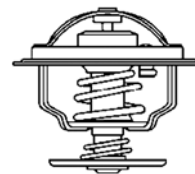

# ROVER

	Engine	Ltr.	Year	Restriction*	Thermostat
414	14 K2F, 14 K4C, 14 K4D, 14 K4F	1.4	1990.04 - 2000.03		410808.88D
416	D 16 A7, D 16 Z2	1.6	1990.04 - 1995.04		4269.78D
416	16 K4F	1.6	1995.05 - 2000.03		410808.88D
416 GTI/GTE	D 16 A8, D 16 A9	1.6	1992.10 - 1995.04		410224.82D
418 D		1.9	1991.09 - 1995.04		4147.80D
418 TD	XUD 7TE	1.8	1991.09 - 1995.04		4147.80D
<b>600 (RH)</b>					
618 i	F 18 A3	1.9	1996.03 - 1999.02		4269.78D
620 i	F 20 Z2	2.0	1993.08 - 1996.06		4269.78D
620 i	F 20 Z1	2.0	1993.08 - 1999.02		4269.78D
623 i	H 23 A3	2.3	1993.08 - 1999.02		4269.78D
<b>800 (XS)</b>					
820 16 V	20 HD	2.0	1986.10 - 1988.10		3004.82
820 i	20 HD	2.0	1988.10 - 1991.12		3004.82
820 SI	20 HD M 16	2.0	1988.10 - 1991.12		3004.82
825 D	425 SL1RR, 492 4 SHIRG	2.5	1990.01 - 1999.02		4158.80D
<b>CABRIOLET (XW)</b>					
214 1.4	14 K4C, 14 K4D	1.4	1990.04 - 1999.11		410808.88D
214 1.4i 16V	14 K4F	1.4	1993.01 - 1999.11		410808.88D
216 1.6i 16V	16 K4F	1.6	1996.01 - 1999.11		410808.88D
<b>COUPE</b>					
1.6 16 V	16 K4F	1.6	1996.03 - 1999.11		410808.88D
1.8 16 V	18 K4K	1.8	1996.03 - 1999.11		410808.88D
<b>MINI</b>					
1000	99 HD 81	1.0	1992.01 - 1993.06		3004.82
1300	12 A2A, 12 A2B	1.3	1991.01 - 2000.11		3004.82
1300	12 A2D, 12 A2E, 12 A2L	1.3	1992.01 - 2000.11		3004.82
<b>MINI Cabriolet (XN)</b>					
1300	12 A2E	1.3	1992.09 - 1995.04		3004.82
<b>MONTEGO Estate (XE)</b>					
2.0 GTI/LXI	20 H	2.0	1990.12 - 1993.12		3004.82

# Thermostats

## SAAB

	Engine	Ltr.	Year	Restriction*	Thermostat
<b>90</b>					
2.0	B 20 I	2.0	1984.08 - 1987.08		4154.82D
<b>95</b>					
1.5 V4	Ford V4	1.5	1965.10 - 1978.12		3021.88D50
<b>96</b>					
1.5 V4	Ford V4	1.5	1965.10 - 1980.08		3021.88D50
<b>99</b>					
1.7		1.7	1968.08 - 1971.05		4022.82D
1.85		1.85	1970.10 - 1974.05		4022.82D
1.85 i		1.85	1971.10 - 1972.09		4022.82D
2.0	B20T, B 20 P	2.0	1972.10 - 1984.01		4022.88D
2.0	B 20 I, B 20 C	2.0	1974.09 - 1984.12		4022.88D
2.0 EMS	B201, B 20 I	2.0	1972.04 - 1978.12		4022.88D
2.0 i	BI 20	2.0	1981.01 - 1984.12		4022.88D
2.0 Turbo		2.0	1977.10 - 1980.06		4022.88D
<b>9-3 (YS3D)</b>					
2.0 i	B204I	2.0	1998.02 - 2003.08		4154.88D
2.0 Turbo	B204E, B204R, B205E, B205L, B204L, B205R	2.0	1998.02 - 2003.08		4154.88D
2.2 TiD	X 22 DTH, D223L	2.2	1998.02 - 2002.09		4193.92D
2.3	B235R	2.3	1999.09 - 2002.01		4154.88D
2.3 i	B234I	2.3	1998.02 - 2003.08		4154.88D
2.3 Turbo	B235R	2.3	1998.10 - 2003.08		4154.88D
<b>9-3 (YS3F)</b>					
1.8 i	Z 18 XE	1.8	2004.01 -		411578.92D ▲
1.8 T	B207E	1.8	2002.09 -		411193.82D
1.8 T BioPower	B207E, B207L	1.8	2007.01 -		411193.82D
1.9 TiD	Z 19 DT, Z 19 DTH, Z 19 DTJ	1.9	2004.09 -		410049.88D
1.9 TTiD	A 19 DTR, Z 19 DTR	1.9	2007.12 -		410049.88D
2.0		2.0	2006.04 - 2007.09		411193.82D
2.0 T	A 20 NFT, B207E, B207G, B207L, B207M, B207R	2.0	2002.09 -		411193.82D
2.0 T BioPower	A 20 NFT, B207H, B207L, B207M, B207R	2.0	2002.09 -		411193.82D
2.0 Turbo	B207R	2.0	2008.01 -		411193.82D
2.0 Turbo Performance		2.0	2004.04 -		411193.82D
2.2 TiD	D223L	2.2	2002.09 -		4297.92D
2.8 Turbo V6	B284L, LP9	2.8	2005.03 -		411193.82D
<b>9-3X</b>					
1.9 TTiD	Z 19 DTR, A 19 DTR	1.9	2009.02 -		410049.88D
2.0 T	B207R	2.0	2009.02 -		411193.82D
2.0 T BioPower	A 20 NFT, B207R	2.0	2009.02 -		411193.82D
<b>9-5 (YS3E)</b>					
1.9 TiD	Z 19 DTH, Z 19 DTR	1.9	2006.01 -		410049.88D
2.0 T	B204R, B205E, B205F, B205L	2.0	1997.09 -		4154.88D
2.0 T BioPower	A 20 NFT, B205E	2.0	2005.01 -		411193.82D

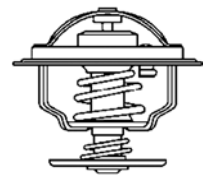

# SAAB

	Engine	Ltr.	Year	Restriction*	Thermostat
2.0 Turbo	B205E	2.0	1998.10 -		4154.88D
2.2 TiD	D223L	2.2	2002.03 -		4297.92D
2.3 T	B235E	2.3	1997.09 -		4154.88D
2.3 T BioPower	B235E, B235R	2.3	2006.11 -		4154.88D
2.3 Turbo	B235E, B235L, B235R	2.3	1999.10 -		4154.88D
<b>9-5 (YS3G)</b>					
1.6 Turbo	A 16 LET	1.6	2010.05 -		4357.92D
2.0 T BioPower	A 20 NFT	2.0	2010.05 -		411193.82D
2.0 Turbo	A 20 NHT	2.0	2010.05 -		411193.82D
<b>900 I</b>					
2.0	B201	2.0	1978.06 - 1989.09		4022.88D
2.0	B202I, B202S, B202S	2.0	1987.10 - 1993.10		4154.82D
2.0 -16	B202I, B202S, B202XI	2.0	1986.01 - 1994.06		4154.82D
2.0 16v	B202I	2.0	1990.04 - 1990.12		4154.82D
2.0 8V Turbo	B201L	2.0	1988.01 - 1990.12		4022.82D
2.0 c	B201XC, B 20, B20T, BT 20	2.0	1978.09 - 1988.12		4022.88D
2.0 EMS	BI 20	2.0	1978.09 - 1980.12		4022.82D
2.0 i	BI 20, B201, B201XI	2.0	1980.11 - 1990.08		4022.88D
2.0 S Turbo-16	B202S	2.0	1991.07 - 1994.06		4154.82D
2.0 T8	B201L	2.0	1986.10 - 1989.09		4022.88D
2.0 Turbo	B201S, BSI 20, B201XL	2.0	1978.09 - 1985.07		4022.82D
2.0 Turbo-16	B202L, B202XL	2.0	1984.02 - 1994.06		4154.82D
2.1 -16	B212I	2.1	1990.08 - 1994.06		4154.82D
2.1 16 S	B212I	2.1	1989.10 - 1992.07	82° Variante	4154.82D
2.1 16 S	B212I	2.1	1989.10 - 1992.07	88° Variante	4154.88D
<b>900 II</b>					
2.0 -16 Turbo	B204L	2.0	1993.07 - 1998.02		4154.88D
2.0 i	B204I, B206I	2.0	1993.07 - 1994.07		4154.88D
2.3 -16	B234I	2.3	1993.07 - 1998.02		4154.88D
2.5 -24 V6	B258I	2.5	1993.07 - 1998.02		4175.92D
<b>9000</b>					
2.0		2.0	1988.10 - 1990.08		4154.82D
2.0 -16	B202I, B202XI, B204I, B204S, B204E	2.0	1985.12 - 1998.12		4154.82D
2.0 -16 Turbo	B202, B202L, B202XL, B204S, B204E, B202S	2.0	1984.09 - 1998.12		4154.82D
2.0 16v	B202L	2.0	1989.09 - 1990.01		4154.82D
2.0 T16		2.0	1989.06 - 1990.10		4154.88D
2.3	B234I, B234R	2.3	1989.10 - 1993.12		4154.82D
2.3 -16	B234I	2.3	1989.08 - 1998.12		4154.82D
2.3 -16 Aero CS	B234R	2.3	1993.02 - 1998.12		4154.82D
2.3 -16 Eco Power	B234E	2.3	1993.09 - 1998.12		4154.82D
2.3 -16 Turbo	B234L	2.3	1990.07 - 1998.12		4154.82D
2.3 -16 Turbo	B234L	2.3	1990.09 - 1998.12		4154.82D
3.0 -24 V6	B308I	3.0	1994.07 - 1998.12		4175.92D

**SEAT**

Engine

Ltr.

Year

Restriction\*

Thermostat

**131**

1.5		1.5	1982.03 - 1985.01		3345.79
2.4 Diesel	8144.61	2.4	1978.06 - 1986.12		4008.79D

**ALHAMBRA**

1.8 T 20V	AWC, AJH	1.8	1997.10 - 2010.03		3141.87D
1.9 TDI	ANU, 1Z, AHU, ARL, BTB, ASZ,AVG, AFN, BVK, AUY	1.9	1996.04 - 2010.03		4264.87D
2.0 i	ATM, ADY	2.0	1996.04 - 2010.03		4264.87D
2.0 TDI	BRT	2.0	2005.11 - 2010.03		4264.87D
2.8 V6	AYL, AUE	2.8	2000.06 - 2010.03		4123.80D

**ALHAMBRA (710)**

2.0 TDI	CFFA, CFFB, CFFE, CFGB	2.0	2010.06 -		410845.87D
---------	------------------------	-----	-----------	--	------------

**ALTEA (5P1)**

1.4 16V	CGGB, BXW	1.4	2006.05 -	mit Gehäuse	410475.87D
1.6	BGU, CCSA, BSF, CMXA, BSE	1.6	2004.03 -		3141.87D
1.6 LPG	CHGA	1.6	2009.09 -		3141.87D
1.6 TDI	CAYC	1.6	2009.10 - 2010.07	mit Gehäuse	410536.92D
1.6 TDI	CAYC	1.6	2009.10 - 2010.07	ohne Gehäuse	410537.92D
1.6 TDI	CAYC	1.6	2010.08 -		410845.92D
1.6 TDI	CAYB	1.6	2010.11 -		410845.92D
1.9 TDI	BJB, BKC, BXE, BXF	1.9	2004.04 -		4264.87D
1.9 TDI	BLS	1.9	2004.04 -		4820.87D
2.0 FSI	BVY, BVZ	2.0	2004.05 - 2009.03		411186.87D
2.0 TDI	AZV, BMN	2.0	2004.03 - 2009.05		3472.87D
2.0 TDI	BMM	2.0	2005.11 -		4820.87D
2.0 TDI	CEGA	2.0	2006.03 - 2009.07		3472.87D
2.0 TDI 16V	BKD	2.0	2004.03 -		3472.87D
2.0 TDI 16V	CFHC	2.0	2004.03 -		410845.87D
2.0 TFSI	BWA	2.0	2006.04 - 2009.05		411187.87D

**ALTEA XL (5P5, 5P8)**

1.4 16V	CGGB, BXW	1.4	2006.10 -	mit Gehäuse	410475.87D
1.6	CCSA, BSF, CMXA, BSE	1.6	2006.10 -		3141.87D
1.6 LPG	CHGA	1.6	2009.09 -		3141.87D
1.6 Multifuel	CCSA	1.6	2006.10 -		3141.87D
1.6 TDI	CAYC	1.6	2009.10 - 2010.07	mit Gehäuse	410536.92D
1.6 TDI	CAYC	1.6	2009.10 - 2010.07	ohne Gehäuse	410537.92D
1.6 TDI	CAYC	1.6	2010.08 -		410845.92D
1.6 TDI	CAYB	1.6	2010.11 -		410845.92D
1.9 TDI	BKC, BXE, BXF	1.9	2006.10 -		4264.87D
1.9 TDI	BLS	1.9	2006.10 -		4820.87D
2.0 TDI	BMM	2.0	2006.10 -		4820.87D
2.0 TDI	AZV, BMN	2.0	2006.11 -		3472.87D
2.0 TDI	CFJA	2.0	2007.06 -		410845.87D
2.0 TDI 16V	BKD	2.0	2006.10 -		3472.87D
2.0 TDI 16V	CFHC	2.0	2006.10 -		410845.87D
2.0 TFSI	BWA	2.0	2007.06 - 2009.05		411187.87D

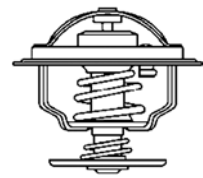

# SEAT

	Engine	Ltr.	Year	Restriction*	Thermostat
<b>AROSA</b>					
1.0	AER, ANV, ALD, ALL, AUC	1.0	1997.05 - 2004.06	mit Gehäuse	410989.87D
1.4	AEX, AKV, ANW, AKK, APQ, AUD	1.4	1997.05 - 2004.06	mit Gehäuse	410989.87D
1.4 16V	AFK, AUB, AQQ	1.4	2000.01 - 2004.06	mit Gehäuse	410989.87D
1.4 TDI	AMF	1.4	2000.01 - 2004.06		4264.87D
1.7 SDI	AKU	1.7	1997.08 - 2004.06		4264.87D
<b>CORDOBA (6K2/C2, 6K5)</b>					
1.0	AAU	1.0	1993.02 - 1996.06		4264.84D
1.0	ANV, ALD, AUC	1.0	1999.06 - 2002.10	mit Gehäuse	410989.87D
1.0 16V	AST, AVZ	1.0	2000.05 - 2002.10	mit Gehäuse	410989.87D
1.0 i	AER	1.0	1996.09 - 1999.06	mit Gehäuse	410989.87D
1.3	2G, AAV	1.3	1993.02 - 1994.08		4264.84D
1.4	ANW, AKK, ANX, AUD, AUB, AQQ	1.4	1997.12 - 2002.12	mit Gehäuse	410989.87D
1.4 16V	APE, AUA, AUB, AQQ	1.4	1999.06 - 2002.12	mit Gehäuse	410989.87D
1.4 i	AEX, AKV, APQ	1.4	1994.06 - 1999.06	mit Gehäuse	410989.87D
1.4 i	ABD	1.4	1994.06 - 1999.06		4264.84D
1.4 i 16V	AFH	1.4	1996.09 - 1999.06	mit Gehäuse	410989.87D
1.6	AEH, AKL, APF, AUR	1.6	1999.06 - 2002.12		3141.87D
1.6	ALM	1.6	1999.06 - 2002.12	mit Gehäuse	410989.87D
1.6 i	AEE, ALM	1.6	1993.02 - 1999.06	mit Gehäuse	410989.87D
1.6 i	1F, ABU, AFT	1.6	1993.02 - 1999.10		4264.87D
1.6 i	AKL	1.6	1996.07 - 1999.10		3141.87D
1.7 SDI	AKU	1.7	1997.07 - 1999.06		4264.87D
1.8 i	ACC, ADZ, ABS	1.8	1993.02 - 1999.06		4264.87D
1.8 i 16V	ADL	1.8	1993.10 - 1996.08		4264.87D
1.8 T 20V Cupra	AYP, AQX	1.8	2000.07 - 2002.10		3141.87D
1.9 D	1Y	1.9	1993.02 - 1996.08		4253.87D
1.9 SDI	AEY, AQM, AGP	1.9	1996.08 - 2002.12		4264.84D
1.9 TD	AAZ	1.9	1993.02 - 1996.08		4253.87D
1.9 TDI	1Z, AHU, AFN, AGR, ALH, ASV	1.9	1996.08 - 2002.12		4264.87D
2.0 i	2E, AGG	2.0	1993.02 - 1999.06		4264.87D
2.0 i 16V	ABF	2.0	1996.08 - 1999.06		4264.84D
<b>CORDOBA (6L2)</b>					
1.2 12V	BXV	1.2	2006.05 - 2009.11	mit Gehäuse	410475.87D
1.4 16V	BBZ, AUB, BBY, BKY, BXW	1.4	2002.09 - 2009.11	mit Gehäuse	410475.87D
1.4 TDI	AMF, BMS, BNM, BNV	1.4	2002.10 - 2009.11		4264.87D
1.6	BAH	1.6	2003.04 - 2009.11	mit Gehäuse	410475.80D
1.9 SDI	ASY	1.9	2002.09 - 2009.11		4264.87D
1.9 TDI	AXR, ATD, BLT, ASZ	1.9	2002.09 - 2009.11		4264.87D
1.9 TDI	BMT	1.9	2002.09 - 2009.11		4820.87D
2.0	AZL, BBX	2.0	2002.09 - 2009.11		3141.87D
<b>EXEO</b>					
2.0 TDI	CAGA, CAHA,, CAGC, CGLB, CJCA, CJCC,	2.0	2008.12 - 2009.08		410396.82D
2.0 TFSI	BWE	2.0	2009.03 -		411186.87D

# Thermostats

## SEAT

	Engine	Ltr.	Year	Restriction*	Thermostat
<b>IBIZA I (021A)</b>					
0.9	146 A 000, 09 NCA	0.9	1990.08 - 1993.05		3361.87D
1.2	021 A 1000	1.2	1984.11 - 1993.12		4256.87D50
1.2 i	021 C.1000	1.2	1989.01 - 1993.05		4256.87D50
1.5	021 A 2000	1.5	1984.11 - 1993.05		4256.87D50
1.5 i	021 B.2000, 021 C.2000, 021 D.2000	1.5	1986.10 - 1993.05		4256.87D50
1.7	021 A.3000, 021 B.3000	1.7	1991.01 - 1993.05		4256.87D50
<b>IBIZA II (6K1)</b>					
1.0	AAU	1.0	1993.03 - 1996.09		4264.84D
1.0 i	AER	1.0	1996.09 - 1999.08	mit Gehäuse	410989.87D
1.3 i	2G, AAV	1.3	1993.03 - 1999.08		4264.84D
1.4 i	AEX, AKV, APQ	1.4	1993.09 - 1999.08	mit Gehäuse	410989.87D
1.4 i	ABD	1.4	1993.09 - 1999.08		4264.84D
1.4 i 16V	AFH	1.4	1997.06 - 1999.08	mit Gehäuse	410989.87D
1.6 i	AEE, ALM	1.6	1993.03 - 1999.08	mit Gehäuse	410989.87D
1.6 i	1F, ABU, AFT	1.6	1993.03 - 1999.08		4264.84D
1.8 i	ACC, ADZ, ABS	1.8	1993.03 - 1999.08		4264.87D
1.8 i 16V	ADL	1.8	1993.11 - 1996.08		4264.87D
1.9 D	1Y	1.9	1993.04 - 1996.08		4253.87D
1.9 SDI	AEY	1.9	1996.08 - 1999.08		4264.84D
1.9 TD	AAZ	1.9	1993.03 - 1996.08		4253.87D
1.9 TDI	1Z, AFN, AHU	1.9	1996.08 - 1999.08		4253.87D
2.0 i	2E, AGG	2.0	1993.03 - 1999.08		4264.87D
2.0 i 16V	ABF	2.0	1996.08 - 1999.08		4264.84D
<b>IBIZA III (6K1)</b>					
1.0	ANV, ALD, AUC	1.0	1999.08 - 2002.02	mit Gehäuse	410989.87D
1.0 16V	AST, AVZ	1.0	1999.10 - 2002.02	mit Gehäuse	410989.87D
1.4	ANW, AKK, AUD	1.4	1999.08 - 2002.02	mit Gehäuse	410989.87D
1.4 16V	AUB, AQQ, APE, AUA	1.4	1999.08 - 2002.02	mit Gehäuse	410989.87D
1.6	AEH, AKL, APF, AUR	1.6	1999.08 - 2002.02		3141.87D
1.6	ALM	1.6	1999.08 - 2002.02	mit Gehäuse	410989.87D
1.8 T 20V Cupra	AYP, AQX	1.8	2000.07 - 2002.02		3141.87D
1.9 SDI	AQM, AGP	1.9	1999.08 - 2002.02		4264.87D
1.9 TDI	AGR, ALH, ASV	1.9	1999.08 - 2002.02		4264.87D
<b>IBIZA IV (6L1)</b>					
1.4 16V	AUB, BBY, BBZ, BKY, BXW	1.4	2002.02 - 2009.11	mit Gehäuse	410475.87D
1.4 TDI	AMF, BMS, BNM, BNV	1.4	2002.05 - 2005.12		4264.87D
1.6	BAH	1.6	2003.02 - 2009.11	mit Gehäuse	410475.80D
1.8 T Cupra R	BBU, BLZ	1.8	2004.01 - 2008.02		3141.87D
1.8 T FR	BKV, BJX	1.8	2003.12 - 2008.05		3141.87D
1.9 SDI	ASY, ASZ, BLT	1.9	2002.02 - 2005.12		4264.87D
1.9 TDI	AXR, ASZ, ATD, BLT	1.9	2002.02 - 2009.11		4264.87D
1.9 TDI	BMT	1.9	2002.02 - 2009.11		4820.87D
1.9 TDI Cupra R	BPX, BUK	1.9	2004.03 - 2008.02		4264.87D
2.0	AZL, BBX	2.0	2002.04 - 2009.11		3141.87D
<b>IBIZA V (6J1, 6J5)</b>					
1.4	CGGB, BXW	1.4	2008.03 -	mit Gehäuse	410475.87D
1.4 TDI	BMS	1.4	2008.07 -		4264.87D
1.6 TDI	CAYB, CAYC, CLNA	1.6	2009.05 - 2010.05	mit Gehäuse	410536.92D
1.6 TDI	CAYB, CAYC, CLNA	1.6	2009.05 - 2010.05	ohne Gehäuse	410537.92D
1.6 TDI	CAYB, CAYC, CLNA	1.6	2010.06 -		410845.92D

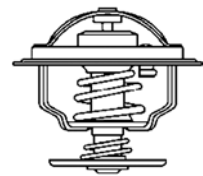

# SEAT

	Engine	Ltr.	Year	Restriction*	Thermostat
1.9 TDI	BLS, BXJ	1.9	2008.03 - 2010.06		4820.87D
2.0 TDI	CFHD	2.0	2010.01 -		410845.87D
<b>IBIZA V ST (6J8)</b>					
1.4	CGGB	1.4	2010.03 -	mit Gehäuse	410475.87D
1.6 TDI	CAYB, CAYC, CLNA	1.6	2010.03 - 2010.05	mit Gehäuse	410536.92D
1.6 TDI	CAYB, CAYC, CLNA	1.6	2010.03 - 2010.05	ohne Gehäuse	410537.92D
1.6 TDI	CAYB, CAYC, CLNA	1.6	2010.06 -		410845.92D
<b>INCA</b>					
1.4 16V	AUA	1.4	2000.04 - 2003.06	mit Gehäuse	410989.87D
1.4 i	AEX, AKV, APQ, AUD	1.4	1995.11 - 2003.06	mit Gehäuse	410989.87D
1.6 i	1F	1.6	1995.11 - 1998.05		4253.87D
1.6 i	AEE, ALM	1.6	1997.06 - 2000.09	mit Gehäuse	410989.87D
1.7 D	AHB	1.7	1996.09 - 2003.06		4264.87D
1.9 D	1Y	1.9	1995.11 - 2003.06		4264.87D
1.9 SDI	AYQ, AEY	1.9	1995.11 - 2003.06		4253.87D
1.9 TDI	ALH	1.9	1996.09 - 2003.06		4253.87D
<b>LEON (1M1) 2006&lt;--</b>					
1.4 16V	AHW, AXP, BCA, APE, AUA	1.4	1999.11 - 2006.06	mit Gehäuse	410989.87D
1.6	AKL, APF, AEH, BGU	1.6	1999.11 - 2006.06		3141.87D
1.6 16 V	AUS, ATN, BCB, AZD	1.6	2000.09 - 2006.06	mit Gehäuse	410989.87D
1.8 20V / T	AGN, APG, AJQ, ARY, APP, AUQ	1.8	1999.11 - 2006.06		3141.87D
1.8 T Cupra R	AMK, BAM	1.8	2002.02 - 2006.06		3141.87D
1.9 SDI	AQM	1.9	1999.11 - 2006.06		4264.87D
1.9 TDI	AGR, ALH, AHF, ASV, ARL, ASZ, AXR	1.9	1999.11 - 2006.06		4264.87D
2.3 VR5	AQN	2.3	2000.09 - 2003.11		4123.80D
2.8	BDE	2.8	2002.05 - 2004.06		4123.80D
2.8 Cupra 4	AUE	2.8	2001.02 - 2006.06		4123.80D
<b>LEON (1P1) 2006→</b>					
1.4 16V	CGGB, BXW	1.4	2006.06 -	mit Gehäuse	410475.87D
1.6	BSE, BSF, CCSA	1.6	2005.07 -		3141.87D
1.6 LPG	CHGA	1.6	2009.12 -		3141.87D
1.6 TDI	CAYC	1.6	2010.02 - 2010.07	mit Gehäuse	410536.92D
1.6 TDI	CAYC	1.6	2010.02 - 2010.07	ohne Gehäuse	410537.92D
1.6 TDI	CAYC	1.6	2010.08 -		410845.92D
1.9 TDI	ASV, BXE, BKC, BXF	1.9	2005.07 -		4264.87D
1.9 TDI	BLS	1.9	2005.07 -		4820.87D
2.0 FSI	BVY, BVZ	2.0	2005.07 - 2010.05		411186.87D
2.0 TDI	AZV, BMN	2.0	2005.07 -		3472.87D
2.0 TDI	BMM	2.0	2005.10 -		4820.87D
2.0 TDI	CFJA	2.0	2006.05 -		410845.87D
2.0 TDI 16V	BKD	2.0	2005.07 -		3472.87D
2.0 TDI 16V	CFHC	2.0	2005.07 -		410845.87D
2.0 TFSI	BWA, BWA1	2.0	2005.05 - 2009.03		411187.87D
<b>MALAGA</b>					
1.2	021 A 1000	1.2	1984.11 - 1993.12		4256.87D50
1.2 i	021 C.1000	1.2	1989.12 - 1993.12		4256.87D50
1.5	021 A 2000	1.5	1985.05 - 1993.12		4256.87D50
1.5 i	021 A 2000, 021 B.2000, 021 C.2000, 021 D.2000	1.5	1986.10 - 1993.12		4256.87D50



# SEAT

Engine

Ltr.

Year

Restriction\*

Thermostat

## MARBELLA

0.8	08 NCA	0.8	1986.08 - 1993.12		3361.87D
0.9	08 NCB	0.9	1987.01 - 1998.10		3361.87D
0.9	100 GL 7000, 09 NCA	0.9	1987.01 - 1996.11		3361.87D

## PANDA (141A)

0.9	100 GL 3000	0.9	1980.10 - 1986.12		3361.87D
-----	-------------	-----	-------------------	--	----------

## RONDA

1.2	021 A 1000, 124 B6.000	1.2	1983.08 - 1986.12		4256.87D50
1.5	021 A 2000	1.5	1984.09 - 1986.12		4256.87D50
1.6	138 AR6.000, 022 A 000	1.6	1983.08 - 1985.09		4256.87D50

## TERRA

0.9	09 NCA, 09 NCB	0.9	1987.01 - 1996.12		3361.87D
1.3 D	MN	1.3	1990.03 - 1994.12		4264.84D
1.4 D	1 W	1.4	1990.10 - 1995.12		4264.84D

## TOLEDO I

1.6 i	EZ, ABN, 1F, AFT	1.6	1991.05 - 1999.03		4264.87D
1.8 16V	KR, PL	1.8	1991.05 - 1999.03		4264.87D
1.8 GT	KR	1.8	1991.05 - 1992.11		4264.87D
1.8 i	ACC, ADZ, ABS, RP	1.8	1991.05 - 1996.12		4264.87D
1.9 D	1Y	1.9	1991.05 - 1999.03		4264.87D
1.9 TD	AAZ	1.9	1991.05 - 1999.03		4264.87D
1.9 TDI	1Z, AHU, AFN	1.9	1995.08 - 1999.03		4264.87D
2.0 i	2E, AGG	2.0	1991.05 - 1999.03		4264.87D
2.0 i 16V	ABF	2.0	1993.11 - 1999.03		4264.84D

## TOLEDO II

1.4 16V	AHW, AXP, BCA, APE, AUA	1.4	1999.07 - 2006.05	mit Gehäuse	410989.87D
1.6	AKL, APF, AEH	1.6	1999.04 - 2000.09		3141.87D
1.6 16V	AUS, BCB, AZD	1.6	2000.09 - 2006.05	mit Gehäuse	410989.87D
1.8	AJQ, AMK, ARY, BAM	1.8	2001.05 - 2005.10		3141.87D
1.8 20V	AGN, APG	1.8	1999.04 - 2006.05		3141.87D
1.8 20VT	APP, AUQ	1.8	2001.05 - 2006.05		3141.87D
1.9 SDI	AQM	1.9	1999.11 - 2004.06		4264.87D
1.9 TDI	AGR, ALH, AHF, ASV, ARL, ASZ, AXR	1.9	1999.04 - 2006.05		4264.87D
2.3 V5	AGZ	2.3	1999.05 - 2001.05	Chassis No. 1M-Y 000 001→	4123.80D
2.3 V5 20V	AQN	2.3	2001.05 - 2006.05		4123.80D
2.8	AUE, BDE	2.8	2000.10 - 2004.04		4123.80D

## TOLEDO III

1.6	BGU, CCSA, BSF, BSE	1.6	2004.10 - 2009.05		3141.87D
1.9 TDI	BJB, BKC, BXE	1.9	2004.10 - 2009.05		4264.87D
1.9 TDI	BLS	1.9	2004.10 - 2009.05		4820.87D
2.0 FSI	BVY, BVZ	2.0	2004.10 - 2009.05		411186.87D
2.0 TDI	AZV	2.0	2004.09 - 2009.05		3472.87D
2.0 TDI	BMM	2.0	2005.11 - 2009.05		4820.87D
2.0 TDI	BMN	2.0	2006.01 - 2009.05		3472.87D
2.0 TDI 16V	BKD	2.0	2004.04 - 2009.05		3472.87D
2.0 TFSI	BWA	2.0	2005.11 - 2009.05		411187.87D

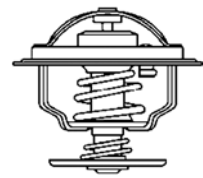

# SKODA

	Engine	Ltr.	Year	Restriction*	Thermostat
<b>100</b>					
1.0	OHV	1.0	1970.01 - 1977.12		<b>3029.83</b>
<b>105, 120</b>					
1.0 105	742,10	1.0	1976.08 - 1990.12		<b>3032.80</b>
1.2 120	742.12	1.2	1976.08 - 1990.12		<b>3032.80</b>
<b>110</b>					
1.1	OHV	1.1	1969.12 - 1982.03		<b>3029.83</b>
<b>130</b>					
G, GL, L (S135, S136)	742,13, 135, 8	1.3	1985.02 - 1991.10		<b>3032.80</b>
<b>FABIA (6Y2, 6Y3, 6Y5)</b>					
1.4	BUD	1.4	2006.02 - 2006.10	mit Gehäuse	<b>410475.87D</b>
1.4 16V	BBY, BKY, AUA, BBZ, AUB, BUD	1.4	2006.04 - 2008.03	mit Gehäuse	<b>410475.87D</b>
1.4 TDI	AMF, BNM, BNV	1.4	2003.04 - 2008.03		<b>4264.87D</b>
1.9 SDI	ASY	1.9	1999.11 - 2008.03		<b>4264.87D</b>
1.9 TDI	AXR, ATD	1.9	2000.01 - 2008.03		<b>4264.87D</b>
1.9 TDI RS	BLT, ASZ	1.9	2003.06 - 2008.03		<b>4264.87D</b>
2.0	AZL	2.0	1999.12 - 2008.03		<b>3141.87D</b>
<b>FABIA</b>					
1.4	CGGB, BXW	1.4	2007.01 -	mit Gehäuse	<b>410475.87D</b>
1.4 TDI	BMS, BNV, BNM	1.4	2007.01 -		<b>4264.87D</b>
1.6 TDI	CAYA, CAYB, CAYC	1.6	2010.04 - 2010.05	mit Gehäuse	<b>410536.92D</b>
1.6 TDI	CAYA, CAYB, CAYC	1.6	2010.04 - 2010.05	ohne Gehäuse	<b>410537.92D</b>
1.6 TDI	CAYA, CAYB, CAYC	1.6	2010.06 -		<b>410845.92D</b>
1.9 TDI	BSW	1.9	2007.04 -		<b>4264.87D</b>
1.9 TDI	BLS	1.9	2007.04 -		<b>4820.87D</b>
<b>FABIA Praktik</b>					
1.4 TDI	BNM	1.4	2005.10 - 2007.12		<b>4264.87D</b>
1.9 SDI	ASY	1.9	2001.07 - 2007.12		<b>4264.87D</b>
<b>FAVORIT</b>					
1.3	135B, 136B	1.3	1991.09 - 1997.06	80° Variante	<b>3032.80</b>
1.3	135B, 136B	1.3	1991.09 - 1997.06	88° Variante	<b>3032.88</b>
1.3 (135 E)	781.135, 781.135 E	1.3	1989.05 - 1997.06	80° Variante	<b>3032.80</b>
1.3 (135), (135 E)	781.135, 781.135 E	1.3	1989.05 - 1997.06	88° Variante	<b>3032.88</b>
1.3 (136)	OHC, 136 B, 136 L	1.3	1990.10 - 1995.06		<b>3032.80</b>
<b>FELICIA I</b>					
1.3	135B, 135 L, 136B,	1.3	1994.10 - 1996.01		<b>3032.88</b>
1.6	AEE, EA111	1.6	1995.08 - 2002.04	mit Gehäuse	<b>410989.87D</b>
1.9 D	AEF	1.9	1995.10 - 2002.04		<b>4253.87D</b>
<b>FELICIA II</b>					
1.6	AEE	1.6	1996.09 - 2004.09	mit Gehäuse	<b>410989.87D</b>
1.9 D	AEF	1.9	1998.01 - 2001.06		<b>4253.87D</b>

# SKODA

	Engine	Ltr.	Year	Restriction*	Thermostat
<b>OCTAVIA (1U)</b>					
1.4 16V	AXP, BCA	1.4	2000.08 - 2010.12	mit Gehäuse	410989.87D
1.6	AEH, AKL	1.6	1997.02 - 2007.12		3141.87D
1.8	AGN	1.8	1996.09 - 2000.07		3141.87D
1.8 20V	AGN	1.8	1998.07 - 2000.07		3141.87D
1.8 T	ARX, ARZ, AGU, AUM	1.8	1997.08 - 2010.12		3141.87D
1.9 SDI	AQM, AGP	1.9	1997.06 - 2003.12		4264.87D
1.9 TDI	AGR, AHF, ALH, ASV, ASZ, ATD, AXR	1.9	1996.09 - 2010.12		4264.87D
2.0	APK, AZH, AZJ, AQY, AEG	2.0	1999.04 - 2007.05		3141.87D
RS 1.8 T	AUQ	1.8	2001.05 - 2006.01		3141.87D
<b>OCTAVIA (1Z)</b>					
1.4	BCA, BUD, CGGA	1.4	2004.05 -	mit Gehäuse	410475.87D
1.6	AEH, AKL, BGU, BSF, BSE, CCSA, CMXA,	1.6	2004.06 -		3141.87D
1.6 LPG	CHGA	1.6	2009.08 -		3141.87D
1.6 MultiFuel	CCSA, CMXA	1.6	2008.01 -		3141.87D
1.6 TDI	CAYC	1.6	2009.06 - 2010.05	mit Gehäuse	410536.92D
1.6 TDI	CAYC	1.6	2009.06 - 2010.05	ohne Gehäuse	410537.92D
1.6 TDI	CAYC	1.6	2010.05 -		410845.92D
1.9 TDI	BJB, BKC, BXE	1.9	2004.06 - 2010.12		4264.87D
1.9 TDI	BLS	1.9	2004.06 - 2010.12		4820.87D
2.0 FSI	BVY, BVZ	2.0	2004.11 -		411186.87D
2.0 RS	BWA, CCZA	2.0	2005.10 -		411187.87D
2.0 TDI	AZV	2.0	2004.02 - 2010.05		3472.87D
2.0 TDI	BMM	2.0	2005.11 -		4820.87D
2.0 TDI	CLCA, CFHF	2.0	2010.03 -		410845.87D
2.0 TDI 16V	AZV, BKD	2.0	2004.02 -		3472.87D
2.0 TDI 16V	CFHC, CLCB	2.0	2004.02 -		410845.87D
2.0 TDI RS	CEGA	2.0	2006.04 - 2009.07		3472.87D
2.0 TDI RS	BMN	2.0	2006.04 -		3472.87D
<b>PRAKTIK</b>					
1.4	CGGB, BXW	1.4	2007.03 -	mit Gehäuse	410475.87D
1.4 TDI	BMS, BNM, BNV	1.4	2007.03 - 2010.03		4264.87D
<b>RAPID (120G, 130G, 135G)</b>					
1.2 (120G)		1.2	1983.02 - 1990.12		3032.80
1.3 (130G)		1.3	1985.03 - 1991.10		3032.80
1.3 S	135, 8	1.3	1984.09 - 1990.12		3032.80
<b>ROOMSTER (5J)</b>					
1.4	CGGB, BXW	1.4	2006.09 -	mit Gehäuse	410475.87D
1.4 TDI	BMS, BNM, BNV	1.4	2006.07 - 2010.03		4264.87D
1.6 TDI	CAYB, CAYC	1.6	2010.03 -	mit Gehäuse	410536.92D
1.6 TDI	CAYB, CAYC	1.6	2010.03 -	ohne Gehäuse	410537.92D
1.6 TDI	CAYB, CAYC	1.6	2010.06 -		410845.92D
1.9 TDI	AXR, BSW	1.9	2006.03 - 2010.03		4264.87D
1.9 TDI	BLS	1.9	2006.09 - 2010.03		4820.87D

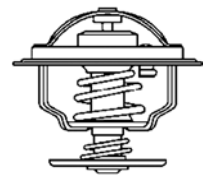

# SKODA

	Engine	Ltr.	Year	Restriction*	Thermostat
<b>SUPERB (3U4)</b>					
1.8 T	AWT	1.8	2001.12 - 2008.03		3141.87D
1.9 TDI	AVB, AWX, AVF, BPZ, BSV	1.9	2001.12 - 2008.03		4264.87D
2.0	AZM	2.0	2001.12 - 2008.03		3141.87D
2.0 TDI	BSS	2.0	2005.10 - 2008.03		4264.87D
2.5 TDI	AYM, BDG	2.5	2001.12 - 2003.08		4274.87D
2.8 V6	AMX	2.8	2001.12 - 2008.03		4274.92D
<b>SUPERB (3T4, 3T5)</b>					
1.6 TDI	CAYC	1.6	2010.09 -		410845.92D
1.9 TDI	BXE	1.9	2008.03 -		4264.87D
1.9 TDI	BLS	1.9	2008.03 -		4820.87D
2.0 TDI	BMP	2.0	2008.03 -		4820.87D
2.0 TDI	CBBB	2.0	2008.07 - 2009.07		3472.87D
2.0 TDI	CFGB	2.0	2008.07 -		410845.87D
2.0 TDI 16V	BKD	2.0	2009.01 -		3472.87D
2.0 TDI 16V	CFFB, CLJA	2.0	2009.01 -		410845.87D
<b>YETI</b>					
1.6 TDI	CAYC	1.6	2010.11 -		410845.92D
2.0 TDI	CFHA, CFHC, CFHF, CFJA, CLCA, CLCB	2.0	2009.05 -		410845.87D

# Thermostats

## SMART (MCC)

Engine

Ltr.

Year

Restriction\*

Thermostat

### CABRIO (450)

0.6	M 160 E6AL B03, M 160 E6AL B05, M 160.920	0.6	2000.03 - 2004.01		3142.90D
0.7	M 160.910	0.7	2003.01 - 2004.01		3142.90D
0.8 CDI	OM 660 DE 8LA, OM 660.940	0.8	2001.03 - 2004.01		3146.90D

### CITY-COUPE (450)

0.8 CDI	OM 660 DE 8LA, OM 660.940	0.8	2001.03 - 2004.01		3146.90D
0.6	M 160 E6AL B03, M 160 E6AL B04, M 160 E6AL B05, M 160.920	0.6	1998.07 - 2004.01		3142.90D
0.7	M 160.910	0.7	2003.01 - 2004.01		3142.90D

### CROSSBLADE (450)

0.6	M 160.920	0.6	2002.06 - 2003.12		3142.90D
-----	-----------	-----	-------------------	--	----------

### FORTWO (450)

0.7	M 160.910	0.7	2004.01 - 2007.01		3142.90D
0.8 CDI	OM 660 DE 8LA, OM 660.940, OM 660.950	0.8	1999.11 - 2007.01		3146.90D

### ROADSTER (452)

0.7	M 160.921, M 160.922	0.7	2003.04 - 2005.11		3142.90D
0.7 Brabus	M 160.923	0.7	2003.12 - 2005.11		3142.90D

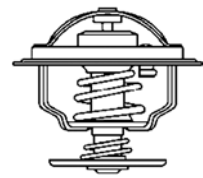

# SSANGYONG

	Engine	Ltr.	Year	Restriction*	Thermostat
<b>KORANDO (KJ)</b>					
2.3 D	OM 601.940	2.3	1996.12 -	ohne Gehäuse	<b>4176.85D</b>
2.3 D	OM 601.940	2.3	1996.12 -	mit Gehäuse	<b>4280.85D</b>
2.9 D	MB-OM 662	2.9	1996.12 -	ohne Gehäuse	<b>4176.85D</b>
2.9 D	MB-OM 662	2.9	1996.12 -	mit Gehäuse	<b>4280.85D</b>
2.9 TD		2.9	1998.04 -	ohne Gehäuse	<b>4176.85D</b>
2.9 TD		2.9	1998.04 -	mit Gehäuse	<b>4280.85D</b>
3.2	M 104.995	3.2	1996.12 -		<b>4078.87D</b>
<b>KORANDO Cabrio (KJ)</b>					
2.9 D	MB-OM 662	2.9	1997.11 -	ohne Gehäuse	<b>4176.85D</b>
2.9 D	MB-OM 662	2.9	1997.11 -	mit Gehäuse	<b>4280.85D</b>
2.9 TD		2.9	1998.04 -	ohne Gehäuse	<b>4176.85D</b>
2.9 TD		2.9	1998.04 -	mit Gehäuse	<b>4280.85D</b>
<b>MUSSO (FJ)</b>					
2.3	M 111.970	2.3	1996.10 -		<b>4276.87D</b>
2.3 D	OM 601.940	2.3	1995.10 -	ohne Gehäuse	<b>4176.85D</b>
2.3 D	OM 601.940	2.3	1995.10 -	mit Gehäuse	<b>4280.85D</b>
2.9 D	MB-OM 662	2.9	1996.03 -	ohne Gehäuse	<b>4176.85D</b>
2.9 D	MB-OM 662	2.9	1996.03 -	mit Gehäuse	<b>4280.85D</b>
2.9 TD		2.9	1998.04 -	ohne Gehäuse	<b>4176.85D</b>
2.9 TD		2.9	1998.04 -	mit Gehäuse	<b>4280.85D</b>
3.2	M 104.992	3.2	1996.06 -		<b>4078.87D</b>
<b>MUSSO SPORTS</b>					
2.9 D		2.9	2004.08 -	ohne Gehäuse	<b>4176.85D</b>
2.9 D		2.9	2004.08 -	mit Gehäuse	<b>4280.85D</b>
<b>REXTON</b>					
2.9 TD		2.9	2002.04 -	ohne Gehäuse	<b>4176.85D</b>
2.9 TD		2.9	2002.04 -	mit Gehäuse	<b>4280.85D</b>

## SUBARU

Engine

Ltr.

Year

Restriction\*

Thermostat

### FORESTER (SF, SG)

2.0	EJ20	2.0	1997.08 - 2002.09		410230.78D
2.0	EJ204	2.0	2005.09 -		410230.78D
2.0 S Turbo	EJ20	2.0	1998.06 - 2001.04		410230.78D
2.0 S Turbo	EJ205	2.0	2001.04 - 2002.09		410230.78D
2.5	EJ25D	2.5	1997.07 - 2002.05		410230.78D
2.5	EJ25	2.5	2002.11 - 2005.08		410230.78D
2.5	EJ255	2.5	2005.01 -		410230.78D
2.5 Turbo		2.5	1998.09 - 2002.05		410230.78D

### FORESTER (SH, SJ)

2.0	EJ20, EJ204	2.0	2008.01 -		411716.88D ▲
2.0	FB 20	2.0	2010.01 -		411716.88D ▲
2.0 D		2.0	2008.09 -		411715.84D ▲
2.5	EJ255	2.5	2008.06 -	78° Variante	410230.78D
2.5	EJ255	2.5	2008.06 -	84° Variante	411715.84D ▲
2.5	EJ25	2.5	2009.01 -	78° Variante	410230.78D
2.5	EJ25	2.5	2009.01 -	84° Variante	411715.84D ▲

### IMPREZA (GC, GF, GFC)

1.5		1.5	1994.11 - 2000.09		410230.78D
1.6	EJ161, EJ16E	1.6	1993.01 - 2000.12		410230.78D
1.6 i	EJ161, EJ16E	1.6	1992.08 - 2000.12		410230.78D
1.8	EJ18	1.8	1993.01 - 1995.10		410230.78D
1.8 i	EJ18, EJ18E	1.8	1992.08 - 2000.12		410230.78D
2.0	EJ20, EJ20E, EJ201, EJ205P	2.0	1995.12 - 2000.12		410230.78D
2.0 i	EJ20, EJ20E, EJ201	2.0	1995.10 - 2000.12		410230.78D
2.0 i 16V	EJ20	2.0	1998.06 - 2000.12		410230.78D
2.0 i Turbo	EJ20 (Turbo)	2.0	1994.03 - 2000.12		410230.78D
2.0 Turbo	EJ20G	2.0	1992.10 - 2000.12		410230.78D
2.0 Turbo GT	EJ20 (Turbo), EJ205	2.0	1994.03 - 2000.12		410230.78D
2.2	EJ22, EJ22E	2.2	1995.11 - 2000.09		410230.78D
2.2 i	EJ22E	2.2	1998.09 - 2000.09		410230.78D

### IMPREZA (GD, GG)

1.5	EL15	1.5	2001.06 - 2005.08		410230.78D
1.6	EJ16, EJ161	1.6	2000.12 - 2006.09		410230.78D
2.0	EJ20	2.0	2000.12 -		410230.78D
2.0	EJ205P	2.0	2005.10 -		410230.78D
2.0 i	EJ20, EJ201, EJ204, EJ205	2.0	2000.12 - 2007.12		410230.78D
2.0 i R	EJ20, EJ204	2.0	2005.09 -		410230.78D
2.0 Turbo	EJ205	2.0	2000.12 -		410230.78D
2.0 WRX STi	EJ207	2.0	2001.11 - 2005.09		410230.78D
2.0 WRX STi	EJ208	2.0	2005.10 -		410230.78D
2.0 WRX Turbo	EJ205	2.0	2000.12 -		410230.78D
2.2	EJ22E	2.2	2001.06 - 2005.08		410230.78D
2.5	EJ25, EJ251	2.5	2001.03 - 2005.09		410230.78D
2.5	EJ255, EJ257	2.5	2005.09 -		410230.78D
2.5 i	EJ251	2.5	2002.12 - 2005.09		410230.78D
2.5 i	EJ255	2.5	2005.09 -		410230.78D
2.5 STi	EJ257	2.5	2005.09 -		410230.78D

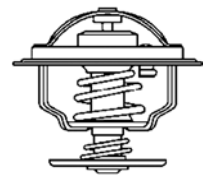

# SUBARU

	Engine	Ltr.	Year	Restriction*	Thermostat
<b>IMPREZA (GR, GH, G3)</b>					
1.5	EL15	1.5	2008.02 -		411716.88D ▲
2.0	EJ204	2.0	2007.12 -		411716.88D ▲
2.0 D		2.0	2009.01 -		411715.84D ▲
2.0 i	EJ204	2.0	2008.01 -		411716.88D ▲
2.5	EJ255	2.5	2008.01 -		410230.78D
2.5	EJ257	2.5	2008.01 -	78° Variante	410230.78D
2.5	EJ257	2.5	2008.01 -	84° Variante	411715.84D ▲
2.5 STi	EJ257	2.5	2011.01 -		410230.78D
2.5 STi CS400	EJ257	2.5	2010.04 -		410230.78D
<b>JUSTY I (KAD)</b>					
1000	EF10	1.0	1984.11 - 1995.10		410183.82D
1200	EF12	1.2	1986.10 - 1995.10		410183.82D
<b>JUSTY II (JMA, MS)</b>					
1.3	EF13	1.3	1995.10 - 2003.11		410229.82D
1.3	G13BB	1.3	2001.04 - 2003.11		410229.82D
<b>JUSTY III (G3X)</b>					
1.3	M13A	1.3	2003.09 -		410229.82D
1.5	M15A	1.5	2003.09 -		410229.82D
<b>LEGACY I (BC, BJF)</b>					
1800	EJ18 SPI	1.8	1989.01 - 1994.07		410230.78D
2.0	EJ20E	2.0	1991.08 - 1993.12		410230.78D
2000	EJ20 EMPI	2.0	1991.08 - 1994.07		410230.78D
2000 Turbo	EJ20-GN	2.0	1992.05 - 1994.07		410230.78D
2200	EJ22 EMPI	2.2	1989.01 - 1994.07		410230.78D
<b>LEGACY II (BD, BG)</b>					
1.8	EJ18E	1.8	1996.05 - 1998.09		410230.78D
2.0 i	EJ20, EJ20 EMPI, EJ20E	2.0	1994.09 - 1999.03		410230.78D
2.2	EJ22	2.2	1994.07 - 1998.11		410230.78D
2.2 i	EJ22 EMPI	2.2	1994.02 - 1999.03		410230.78D
2.5	EJ25D	2.5	1996.01 - 1999.12		410230.78D
2.5 i	EJ25D	2.5	1996.06 - 1999.03		410230.78D
<b>LEGACY III (BE, BH)</b>					
2.0	EJ20, EJ205P, EJ206	2.0	1998.12 - 2003.08		410230.78D
2.5	EJ25	2.5	1998.10 - 2003.08		410230.78D
3.0 H6	EZ30	3.0	2000.08 - 2003.08		410230.78D
<b>LEGACY IV</b>					
2.0	EJ20	2.0	2003.09 -		410230.78D
2.0 D		2.0	2008.02 -		411715.84D ▲
2.0 R	EJ204	2.0	2007.09 -		411716.88D ▲
2.5	EJ25	2.5	2003.09 -		411743.82D ▲
2.5 i	EJ25	2.5	2007.09 -		411743.82D ▲
3.0 R	EZ30	3.0	2003.09 -		411743.82D ▲



## SUBARU

	Engine	Ltr.	Year	Restriction*	Thermostat
<b>LEGACY V</b>					
2.0 D		2.0	2009.09 -		411715.84D ▲
2.0 i	EJ204	2.0	2009.09 -		411716.88D ▲
2.5 GT	EJ255	2.5	2010.07 -		411715.84D ▲
2.5 i	EJ253	2.5	2009.09 -		411716.88D ▲
<b>LEONE I</b>					
1300	EA65	1.3	1979.03 - 1984.10		3118.82D1
1600	EA71	1.6	1979.03 - 1984.10		3118.82D1
1800	EA81	1.8	1980.09 - 1984.10		3118.82D1
<b>LEONE II</b>					
1.6	EA71	1.6	1985.06 - 1990.07		3118.82D1
1.8	EA81, EA82	1.8	1985.06 - 1989.07		3118.82D1
1.8 Turbo	EA82	1.8	1985.06 - 1986.07		3118.82D1
1300	EA65	1.3	1984.11 - 1991.09		3118.82D1
1600	EA71	1.6	1984.11 - 1994.12		3118.82D1
1800	EA82	1.8	1984.11 - 1992.02		3118.82D1
1800 Turbo	EA82	1.8	1984.11 - 1990.12		3118.82D1
<b>LIBERO Bus (E10, E12)</b>					
1.0	EF10	1.0	1983.01 - 1987.12		410183.82D
1.2	EF12	1.2	1986.08 - 2000.02		410183.82D
1.2 i	EF12	1.2	1991.08 - 2000.02		410183.82D
<b>OUTBACK (BE, BH)</b>					
2.5	EJ25	2.5	2000.10 - 2003.08		410230.78D
3.0 H6	EZ30	3.0	2000.10 - 2003.08		410230.78D
<b>OUTBACK (BL, BP)</b>					
2.0	EJ20	2.0	2003.09 - 2005.10		410230.78D
2.0 D		2.0	2008.09 - 2009.09		411715.84D ▲
2.5	EJ25D	2.5	2003.11 - 2009.09		411743.82D ▲
2.5	EJ251	2.5	2008.09 - 2009.09		411743.82D ▲
3.0	EZ30	3.0	2003.11 - 2009.09		411743.82D ▲
<b>OUTBACK (BM, BR)</b>					
2.0 D		2.0	2009.09 -		411715.84D ▲
2.5 i	EJ253	2.5	2009.09 -		411716.88D ▲
3.6	EZ36D	3.6	2009.09 -		411743.82D ▲
<b>REX III</b>					
0.7	EN07E	0.7	1990.07 - 1992.03		410183.82D
<b>SVX (CX)</b>					
3.3		3.3	1994.02 - 1997.12		410230.78D
3.3 i 24V	EG33 DOHC	3.3	1992.09 - 1997.12		410230.78D
<b>TRIBECA (B9)</b>					
3.0	EZ30	3.0	2005.01 -		411743.82D ▲
3.6	EZ36D	3.6	2007.09 -		411743.82D ▲

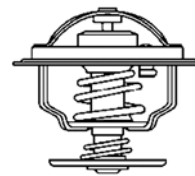

# SUBARU

	Engine	Ltr.	Year	Restriction*	Thermostat
<b>VIVIO</b>					
660	EN07E	0.7	1992.03 - 1995.10		<b>410183.82D</b>
0.7	EN07E	0.7	1992.08 - 1998.12		<b>410183.82D</b>
<b>XT Coupe (XT)</b>					
1.8 Turbo	EA82	1.8	1985.11 - 1990.07		<b>3118.82D1</b>
<b>XV</b>					
2.0 D		2.0	2012.03 -		<b>411715.84D ▲</b>

**SUZUKI**

Engine

Ltr.

Year

Restriction\*

Thermostat

**ALTO I (SS80)**

0.8 F8A, F8B 0.8 1982.06 - 1985.12 410183.82D

**ALTO II (EC)**

0.8 F8B 0.8 1986.01 - 1993.11 410183.82D

**ALTO III (EF)**

1.0 G10BB 1.0 1994.09 - 2002.06 410183.82D

1.3 G13BB 1.3 1998.10 - 2000.09 410183.82D

**ALTO IV (FF)**

1.1 F10DN, F10D 1.1 2002.06 - 2008.12 410183.88D

**APV (GD)**

1.5 G15A 1.5 2005.06 - 410183.82D

**BALENO (EG)**

1.3 G13BA 1.3 1996.09 - 2002.05 410183.88D

1.3 16V G13BB 1.3 1997.03 - 2002.05 410183.88D

1.3 i 16V G13BB 1.3 1995.07 - 2002.05 410183.88D

1.6 i 16V G16B 1.6 1995.07 - 2002.05 410183.88D

1.8 GTX J18A 1.8 1996.03 - 2002.05 410229.82D

1.8 i J18A 1.8 1996.03 - 2002.05 410229.82D

1.8 i 16V J18A 1.8 1996.08 - 2002.05 410229.82D

1.9 TD 1.9 1998.04 - 2002.05 4446.83D

**CAPPUCINO (EA)**

0.7 F6A 0.7 1992.02 - 1995.08 410183.82D

**CARRY Kasten (FD)**

1.3 G13BB 1.3 1999.03 - 410183.82D

1.3 16V G13BB 1.3 2000.03 - 410183.88D

**CARRY Kasten (ST90V)**

0.8 F8A 0.8 1980.11 - 1985.10 3119.82

**GRAND VITARA I (FT, GT)**

1.6 G16B 1.6 1998.03 - 2003.07 410183.88D

1.6 G16B 1.6 2000.02 - 2002.09 410228.82D

2.0 J20A 2.0 1998.03 - 2005.08 410229.82D

2.0 HDI 110 RHZ 2.0 2001.07 - 2005.09 4446.83D

2.0 HDI 110 16V RHW 2.0 2001.07 - 2005.09 4446.83D

2.0 TD RF 2.0 1998.03 - 2003.07 3468.88D

2.0 TD RFM 2.0 2000.04 - 2005.09 4446.83D

2.5 V6 24V H 25 A 2.5 1998.04 - 2003.07 4639.82D

2.7 H 27 A 2.7 2001.06 - 2006.08 4639.82D

**GRAND VITARA II (JT)**

1.6 M16A 1.6 2005.04 - 410229.82D

1.9 DDiS F9QB 1.9 2005.10 - 410538.89D

2.0 J20A 2.0 2005.10 - 410229.82D

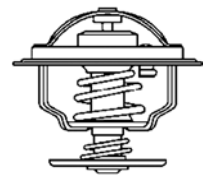

# SUZUKI

	Engine	Ltr.	Year	Restriction*	Thermostat
2.4	J24B	2.4	2009.01 -		410229.82D
2.7	H 27 A	2.7	2005.09 - 2006.12		4639.82D
<b>IGNIS (FH)</b>					
1.3	M13A	1.3	2000.10 - 2003.09		410229.82D
1.3 DDiS	Z13DT	1.3	2003.09 -		410588.88D
1.5	M15A	1.5	2003.09 -		410229.82D
<b>JIMNY (FJ)</b>					
1.3 16V	G13BB	1.3	1998.09 - 2000.08		410183.88D
1.3 16V	M13A	1.3	2001.02 -		410229.82D
1.5 DDiS	K9K 266	1.5	2005.08 - 2007.06		411043.89D
1.5 DDiS	K9K 266	1.5	2007.07 -		411477.89D ▲
<b>KEI</b>					
1.3	G13BA	1.3	1998.09 -		410183.88D
<b>KIZASHI (FR)</b>					
2.4	J24B	2.4	2010.10 -		410229.82D
<b>LIANA (ER)</b>					
1.3	M13A	1.3	2001.07 - 2007.12		410229.82D
1.5	M15A	1.5	2004.04 - 2007.11		410229.82D
1.6	M16A	1.6	2001.07 - 2007.12		410229.82D
1.6 i	M16A	1.6	2002.04 - 2007.12		410229.82D
2.3		2.3	2004.04 - 2007.11		410229.82D
<b>LJ 80</b>					
0.8	F8A	0.8	1980.01 - 1984.01		410228.82D
<b>SAMURAI (SJ)</b>					
1.0	F10A	1.0	1988.11 - 2004.12		410228.82D
1.3	G13A	1.3	1988.11 - 2004.12		3119.82
1.3	G13BA	1.3	2000.01 - 2004.12		410183.88D
1.9 D		1.9	2000.09 - 2004.12		410517.89D
1.9 TD	XUD9	1.9	1998.11 - 2004.12		4446.83D
<b>SJ 410</b>					
1.0	F10A	1.0	1981.09 - 1988.12		3119.82
<b>SJ 413</b>					
1.3	G13A	1.3	1984.09 - 1990.08		3119.82
<b>SPLASH</b>					
1.3 CDTI	D13A, Z 13 DTJ	1.3	2008.01 -		410588.88D
<b>SUPER CARRY Bus (ED)</b>					
1.0	F10A	1.0	1985.10 - 1999.03		3119.82

## SUZUKI

Engine

Ltr.

Year

Restriction\*

Thermostat

### SWIFT I

1.0	G10A , G10	1.0	1983.10 - 1989.03		410183.82D
1.0 Turbo	G10T	1.0	1985.02 - 1989.12		410183.82D
1.3	G13A	1.3	1984.10 - 1989.03		410183.82D
1.3 GTi / GXi	G13B	1.3	1985.08 - 1989.03		410183.82D

### SWIFT II

1.0	G10A	1.0	1989.03 - 2001.05		410183.82D
1.0 i	G10A	1.0	1989.03 - 2001.05		410183.82D
1.3	G13A, G13BA, G13BB	1.3	1989.03 - 2003.12		410183.88D
1.3 GTi	G13B	1.3	1989.03 - 2001.05		410183.82D
1.6	G16B	1.6	1989.03 - 1996.10		410183.82D
1.6 i	G16B	1.6	1990.01 - 2001.05		410183.82D

### SWIFT III

1.3	M13A	1.3	2005.02 -		410229.82D
1.3 DDiS	D 13A, Z 13 DT, Z 13 DTJ	1.3	2005.08 -		410588.88D
1.5	M15A	1.5	2005.02 -		410229.82D
1.6	M16A	1.6	2006.05 -		410229.82D

### SWIFT IV (FZ, NZ)

1.3 DDiS	D13A	1.3	2010.10 -		410588.88D
1.6	M16A	1.6	2012.01 -		410229.82D

### SWIFT Cabriolet (SF413)

1.3 i	G13BA	1.3	1991.09 - 1996.10		410183.82D
-------	-------	-----	-------------------	--	------------

### SX4 (GY)

1.5	M15A	1.5	2006.06 -		410229.82D
1.5 VVT	M15A	1.5	2010.07 -		410229.82D
1.6	M16A	1.6	2007.10 -		410229.82D
1.6 VVT	M16A	1.6	2006.06 -		410229.82D
1.9 DDiS	D19AA	1.9	2006.06 -		410049.88D
2.0	J20A	2.0	2006.06 -		410229.82D

### SX4 S-Cross

1.6		1.6	2013.08 -		410229.82D
-----	--	-----	-----------	--	------------

### VITARA (ET, TA)

1.6	G16A (8V)	1.6	1988.07 - 1998.03		410228.82D
1.6 i 16V	G16B	1.6	1990.07 - 1999.03		410183.88D
1.9 D	XUD9A, XUD9SD	1.9	1995.01 - 1998.03		4446.83D
2.0 16V	J20A	2.0	1996.12 - 1999.03		410229.82D
2.0 HDI	RHP (DW10TD)	2.0	2003.12 - 2005.12		4446.83D
2.0 TD	RF	2.0	1994.12 - 1998.03		3468.88D
2.0 TD Intercooler	RF	2.0	1995.12 - 1998.03		3468.88D
2.0 V6 24V	H 20 A	2.0	1994.12 - 1998.03		4639.82D
2.5 V6 24V	H 25 A	2.5	1995.12 - 1998.03		4639.82D
HDI	RHP (DW10TD)	2.0	2003.12 - 2005.12		4446.83D

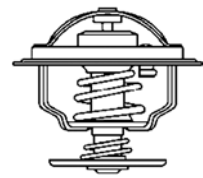

# SUZUKI

	Engine	Ltr.	Year	Restriction*	Thermostat
<b>WAGON</b>					
1.0	K10A	1.0	1998.02 - 2000.05		<b>410183.82D</b>
1.0	G10A	1.0	2003.07 - 2005.08	Fahrgestellnummer →685G062128	<b>410183.88D</b>
1.0	Z 10 XEP	1.0	2004.06 - 2005.08		<b>410183.82D</b>
1.2	K12A	1.2	1998.02 - 2000.05		<b>410183.82D</b>
1.2	Z 12 XEP	1.2	2004.06 - 2005.08		<b>410183.82D</b>
1.3	G13BB	1.3	2000.05 -		<b>410183.88D</b>
1.3	M13A	1.3	2001.08 -		<b>410229.82D</b>
1.3 DDiS	Z13DT	1.3	2003.09 -		<b>410588.88D</b>
<b>X-90 (EL)</b>					
1.6 i 16V	G16B	1.6	1995.09 - 1997.12		<b>410228.82D</b>

# TALBOT

Engine

Ltr.

Year

Restriction\*

Thermostat

## 1307-1510

1510 1.6	6J2A	1.6	1981.07 - 1982.06		4026.89
----------	------	-----	-------------------	--	---------

## EXPRESS

1.8	XM7T	1.8	1981.07 - 1990.10	82° Variante	3061.82
-----	------	-----	-------------------	--------------	---------

1.8	XM7T	1.8	1981.07 - 1990.10	88° Variante	3061.88
-----	------	-----	-------------------	--------------	---------

1.9 D	XUD9A	1.9	1987.07 - 1990.10		4147.80D
-------	-------	-----	-------------------	--	----------

2.0	XN1TA	2.0	1982.07 - 1994.10	82° Variante	3061.82
-----	-------	-----	-------------------	--------------	---------

2.0	XN1TA	2.0	1982.07 - 1994.10	88° Variante	3061.88
-----	-------	-----	-------------------	--------------	---------

2.5 D	CRD93	2.5	1982.07 - 1994.10		3033.84D ▲
-------	-------	-----	-------------------	--	------------

2.5 TD	CRD93LS	2.5	1987.06 - 1994.10		3033.84D ▲
--------	---------	-----	-------------------	--	------------

## HORIZON

1.1	E1B	1.1	1979.01 - 1984.09		4026.89
-----	-----	-----	-------------------	--	---------

1.3	2G1-BTC	1.3	1978.09 - 1986.06		4026.89
-----	---------	-----	-------------------	--	---------

1.4	2Y1, 2Y2	1.4	1979.07 - 1986.06		4026.89
-----	----------	-----	-------------------	--	---------

1.6	6J2A, J2A	1.6	1982.07 - 1986.06		4026.89
-----	-----------	-----	-------------------	--	---------

1.9 Diesel	XUD9	1.9	1982.07 - 1986.06		4147.80D
------------	------	-----	-------------------	--	----------

## MURENA

2.1	5N2	2.1	1980.09 - 1984.07		4026.89
-----	-----	-----	-------------------	--	---------

2.1 S	X5N2	2.1	1983.04 - 1985.01		4026.89
-------	------	-----	-------------------	--	---------

## SAMBA (51A)

0.9	5C1(XV8), 5C1(XV5)	0.9	1981.01 - 1985.12		3136.82D50
-----	--------------------	-----	-------------------	--	------------

1.1	XW7	1.1	1981.01 - 1986.06		3136.82D50
-----	-----	-----	-------------------	--	------------

1.2 Rallye	129 D	1.2	1983.01 - 1986.10		3136.82D50
------------	-------	-----	-------------------	--	------------

1.4	XY8, XY7	1.4	1981.01 - 1986.06		3136.82D50
-----	----------	-----	-------------------	--	------------

1.4	150 D	1.4	1983.06 - 1986.10		3136.82D50
-----	-------	-----	-------------------	--	------------

1.4 Rallye	XY8	1.4	1983.01 - 1986.10		3136.82D50
------------	-----	-----	-------------------	--	------------

## SAMBA Cabriolet (51E)

1.4	XY8	1.4	1981.01 - 1986.06		3136.82D50
-----	-----	-----	-------------------	--	------------

## TAGORA

2.1	5N2	2.1	1980.06 - 1983.12		4026.89
-----	-----	-----	-------------------	--	---------

2.3 Turbo Diesel	XD2S	2.3	1981.08 - 1987.12		3053.75
------------------	------	-----	-------------------	--	---------

2.6	9L6	2.6	1981.08 - 1983.10		4122.87D
-----	-----	-----	-------------------	--	----------

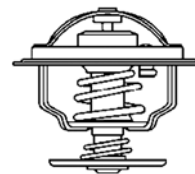

# TOYOTA

	Engine	Ltr.	Year	Restriction*	Thermostat
<b>4 RUNNER</b>					
2.4 TD	2L-T	2.4	1989.08 - 1995.11		3477.88D
2.7 i	3RZ-FE	2.7	1995.11 - 1996.03		410178.82D
3.0 Turbo-D	1KZ-T	3.0	1993.10 - 2002.11		410181.82D
3.4 i	5VZ-FE	3.4	1995.11 - 1996.03		4480.82D
<b>ALPHARD</b>					
2.4	2AZ-FE	2.4	2003.09 - 2008.04		4480.82D
2.4 Hybrid	2AZ-FXE	2.4	2003.09 - 2008.04		4480.82D
3.0	1MZ-FE	3.0	2003.04 - 2008.04		4480.82D
3.5	2GR-FE	3.5	2008.04 -		4480.82D
<b>ALTEZZA</b>					
2.0	1G-GE	2.0	1999.01 - 2001.06		411545.82D ▲
2.0 VVTi	1G-FE	2.0	2001.07 - 2005.07		411545.82D ▲
3.0	2JZ-GE	3.0	2001.07 - 2005.07		410231.82D
<b>ARISTO</b>					
3.0	2JZ-GTE	3.0	1990.10 - 2004.09		410231.82D
<b>AURION</b>					
3.5	2GR-FE	3.5	2006.03 - 2011.09		4480.82D
<b>AURIS</b>					
1.4 D-4D	1ND-TV	1.4	2007.03 - 2013.04		410231.82D
1.4 VVTi	4ZZ-FE	1.4	2007.03 -		4480.82D
1.6	1ZR-FAE	1.6	2009.05 -		4480.82D
1.6 VVTi	1ZR-FE	1.6	2007.03 -		4480.82D
1.8	2ZR-FAE	1.8	2009.02 -		4480.82D
1.8 VVTi	2ZR-FE	1.8	2006.10 -		4480.82D
2.0 D-4D	1AD-FTV	2.0	2007.03 -		4480.82D
2.2 D	2AD-FHV	2.2	2007.03 -		4480.82D
2.4 VVTi	2AZ-FE	2.4	2007.04 -		4480.82D
3.5 VVTi	2GR-FE	3.5	2007.04 -		4480.82D
<b>AVALON</b>					
3.0	1MZ-FE	3.0	2000.04 - 2005.06		4480.82D
<b>AVANZA</b>					
1.3	K3-VE	1.3	2003.12 -		410201.80D
1.5	3SZ-VE	1.5	2006.08 -		410201.80D
<b>AVENSIS</b>					
1.6	4A-FE	1.6	1997.09 - 2000.10		3478.82D
1.6	1ZR-FAE	1.6	2009.02 -		4480.82D
1.6 VVT-i	3ZZ-FE	1.6	2000.10 - 2008.11		4480.82D
1.8	7A-FE	1.8	1997.09 - 2000.10		3478.82D
1.8	1ZZ-FE	1.8	2003.04 - 2008.11		4480.82D
1.8	2ZR-FAE	1.8	2009.02 -		4480.82D
1.8 VVT-i	1ZZ-FE	1.8	2000.10 - 2003.02		4480.82D
1.9 D	2C-T	1.9	1997.10 - 1998.05		3478.82D
1.9 D	1CD-FTV	1.9	2002.09 - 2003.02		410231.82D



# Thermostats

## TOYOTA

	Engine	Ltr.	Year	Restriction*	Thermostat
2.0	3S-FE	2.0	1997.09 - 2000.10		3478.82D
2.0	1AZ-FSE	2.0	2003.04 - 2008.11		4480.82D
2.0	3ZR-FAE	2.0	2009.02 -		4480.82D
2.0 D	2C-T	2.0	1997.10 - 1998.05		3478.82D
2.0 D	1CD-FTV	2.0	2002.09 - 2003.02		410231.82D
2.0 D-4D	1CD-FTV	2.0	1999.10 - 2008.11		410231.82D
2.0 D-4D	1AD-FTV	2.0	2006.03 - 2008.11		410231.82D
2.0 D-4D	1AD-FTV	2.0	2009.02 -		4480.82D
2.0 TD	2C-TE	2.0	1997.09 - 2003.02		3478.82D
2.0 VVTi	1AZ-FE	2.0	2001.08 - 2009.11		4480.82D
2.0 VVT-i	1AZ-FSE	2.0	2000.10 - 2003.02		4480.82D
2.2 D-4D	2AD-FTV	2.2	2005.10 - 2008.11		4480.82D
2.2 D-4D	2AD-FHV, 2AD-FTV	2.2	2009.02 -		4480.82D
2.2 D-CAT	2AD-FHV	2.2	2005.07 - 2008.11		4480.82D
2.4	2AZ-FSE	2.4	2003.09 - 2008.11		4480.82D
2.4 VVTi	2AZ-FE	2.4	2003.10 - 2009.11		4480.82D
<b>CALDINA</b>					
1.8	7A-FE	1.8	1997.10 - 2001.09		3478.82D
<b>CAMI</b>					
1.3	K3-VE, K3-VET	1.3	1999.06 - 2005.12		410201.80D
<b>CAMRY (_V1_) 1983→1988</b>					
1.8	1S-L	1.8	1983.02 - 1986.10		4103.82D
1.8 Turbo-D	1C-TL	1.8	1983.11 - 1988.01		4103.82D
2.0	2S-E, 2S-EL, 2S-ELC, 3S-FE	2.0	1983.01 - 1988.07		4103.82D
<b>CAMRY (_V1_) 1991→1996</b>					
2.0	3S-FSE	2.0	1993.08 - 1997.09		4103.82D
2.2	5S-FE	2.2	1991.06 - 1996.08		3478.82D
2000ZX	3S-FE	2.0	1991.06 - 1997.09		4103.82D
3.0	1MZ-FE, 3VZ-FE	3.0	1991.06 - 1996.08		4480.82D
<b>CAMRY (_V2_) 1986→1991</b>					
1.8	1S	1.8	1986.11 - 1988.08		4103.82D
1.8 i	1S-L	1.8	1986.10 - 1988.08		4103.82D
2.0	3S-FE	2.0	1989.09 - 1991.06		3478.82D
2.0	3S-FC	2.0	1989.09 - 1991.06		3478.82D
2.0 GLi	3S-FE	2.0	1987.10 - 1991.05		4103.82D
2.0 Gli 16V	3S-FE	2.0	1986.11 - 1991.05		4103.82D
2.0 Turbo-D	2C-T	2.0	1986.11 - 1991.05		4103.82D
2.5	2VZ-FE	2.5	1990.01 - 1991.05		4480.82D
<b>CAMRY (_V2_) 1996→2001</b>					
2.2	5S-FE	2.2	1996.08 - 2001.11		3478.82D
3.0 24V	1MZ-FE	3.0	1996.08 - 2001.11		4480.82D
3.0 V6	1MZ-FE	3.0	1996.08 - 2001.11		4480.82D
<b>CAMRY (_V3_) 2001→</b>					
2.0 VVTi	1AZ-FE	2.0	2001.08 - 2006.11		4480.82D
2.4 VVT-i	2AZ-FE	2.4	2001.11 - 2006.11		4480.82D
3.0	1MZ-FE	3.0	2002.09 - 2006.06		4480.82D
3.0 V6	1MZ-FE	3.0	2001.11 - 2006.11		4480.82D

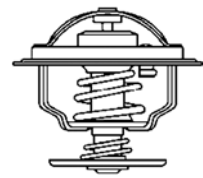

# TOYOTA

	Engine	Ltr.	Year	Restriction*	Thermostat
3.3 VVTi	3MZ-FE	3.3	2002.08 - 2005.12		4480.82D
3.5 VVTi	2GR-FE	3.5	2006.01 - 2006.11		4480.82D
<b>CAMRY SOLARA (_V2_, _V3_)</b>					
2.2	5S-FE	2.2	1998.06 - 2002.11		3478.82D
2.4	2AZ-FE	2.4	2003.07 - 2008.11		4480.82D
3.0	1MZ-FE	3.0	1998.06 - 2008.11		4480.82D
3.3	3MZ-FE	3.3	2003.07 - 2008.11		4480.82D
<b>CAMRY (_V4_)</b>					
2.0 VVT-i	1AZ-FE	2.0	2006.01 - 2011.09		4480.82D
2.4 VVTi	2AZ-FE, 2AZ-FXE	2.4	2006.01 - 2011.09		4480.82D
2.5 VVTi	2AR-FE	2.5	2010.01 - 2011.09		4480.82D
3.5	2GR-FE	3.5	2008.01 - 2011.09		4480.82D
<b>CARINA (TA4, TA6) 1978→1983</b>					
1.6	2T	1.6	1978.01 - 1983.09		3119.82D5
1.8	3T, 3T-C	1.8	1978.01 - 1983.09		3119.82D5
1.8 D	1C	1.8	1982.04 - 1983.09		4103.82D
<b>CARINA II (_T15_) 1983→1988</b>					
1.6	4A-L, 4A-LC	1.6	1983.10 - 1987.11		4103.82D
1.8 GLI	1S-EL, 1S-L	1.8	1983.10 - 1987.11		4103.82D
2.0 D	2C-L	2.0	1984.02 - 1988.05		4103.82D
<b>CARINA II (_T17_) 1988→1993</b>					
1.6	4A-F, 4A-FE	1.6	1987.12 - 1992.03		4103.82D
1.8	4S-FI	1.8	1987.12 - 1992.03		4103.82D
2.0	3S-FE	2.0	1987.12 - 1992.04		4103.82D
2.0 D	2C, 2C-L	2.0	1988.03 - 1992.06		4103.82D
<b>CARINA E (_T19_) 1992→1997</b>					
1.6	4A-FE	1.6	1992.04 - 1997.09		3478.82D
1.6 16V	4A-FE	1.6	1994.12 - 1997.09		3478.82D
1.6 i	4A-FE	1.6	1995.02 - 1997.09		3478.82D
1.8	7A-FE	1.8	1992.04 - 1997.09		3478.82D
1.8 i	7A-FE	1.8	1995.02 - 1997.09		3478.82D
1.8 i 16V	7A-FE	1.8	1995.01 - 1997.09		3478.82D
2.0	3S-FE	2.0	1992.04 - 1997.09		3478.82D
2.0 D	2C	2.0	1992.04 - 1996.01		3478.82D
2.0 Gti	3S-GE	2.0	1992.04 - 1994.02		4480.82D
2.0 GTi 16V	3S-GE	2.0	1994.03 - 1997.09		4480.82D
2.0 i	3S-FE	2.0	1992.12 - 1997.09		3478.82D
2.0 TD	2C-T	2.0	1996.01 - 1997.09		3478.82D
<b>CELICA (_T16_) 1985→1990</b>					
1.6	4A-GELC, 4A-L	1.6	1986.04 - 1989.08		4103.82D
1.6 16V	4A-GEL	1.6	1985.09 - 1989.08		4103.82D
1.8	1S-EL	1.8	1987.08 - 1989.08		3478.82D
1.8	1S-ILU	1.8	1987.08 - 1989.08		4103.82D
2.0	3S-GEL, 3S-GELC	2.0	1985.08 - 1989.08		4103.82D
2.0 Turbo	3S-GTE	2.0	1988.03 - 1989.08		4480.82D

# Thermostats

## TOYOTA

Engine

Ltr.

Year

Restriction\*

Thermostat

### CELICA (\_T18\_) 1989→1994

1.6 STi	4A-FE	1.6	1989.10 - 1993.11		4103.82D
2.0 GTi	3S-GE	2.0	1989.10 - 1993.11		4480.82D
2.0 Turbo	3S-GTE	2.0	1989.10 - 1993.11		4480.82D

### CELICA (\_T20\_) 1993→1999

1.8 i 16V	7A-FE	1.8	1993.11 - 1996.08		3478.82D
2.0 i 16V	3S-GE	2.0	1996.04 - 1999.11		4480.82D
2.2 GT	5S-FE	2.2	1993.11 - 1999.08		3478.82D

### CELICA Coupe (\_A6\_) 1981→1986

1.6	4A-GE	1.6	1983.12 - 1985.12		4103.82D
2.0	18R-G	2.0	1982.01 - 1985.12		3119.82D5
2.0	21R-U	2.0	1982.01 - 1985.12		3119.88D5

### CELICA (ZZT23\_) 1999→

1.8 16V TS	2ZZ-GE	1.8	1999.08 - 2005.09		4480.82D
1.8 16V VT-i	1ZZ-FE	1.8	1999.08 - 2005.07		4480.82D

### COROLLA (\_E10\_) 1992→1999

1.3	4E-FE	1.3	1992.07 - 1997.04		4103.82D
1.3 12V	2E	1.3	1992.07 - 1997.04		3478.82D
1.3 16V	4E-FE	1.3	1992.07 - 1995.09		4103.82D
1.6	4A-FE	1.6	1992.05 - 1997.04		4103.82D
1.8	7A-FE	1.8	1992.05 - 1995.07		3478.82D
1.8	7A-FE	1.8	1992.05 - 1997.04		3478.82D
1.8 16V	7A-FE	1.8	1995.09 - 1997.04		3478.82D
2.0 D	2C	2.0	1992.07 - 1997.04		4103.82D

### COROLLA (\_E11\_) 1997→2002

1.3	2E	1.3	1997.05 - 2001.10		3478.82D
1.4	4E-FE	1.4	1997.04 - 2000.02		4103.82D
1.4	4ZZ-FE	1.4	2000.02 - 2002.01		4480.82D
1.4 16V	4ZZ-FE	1.4	2000.02 - 2001.11		4480.82D
1.5	1NZ-FE	1.5	1999.09 - 2001.10		410231.82D
1.6	4A-FE	1.6	1997.04 - 2000.02		4103.82D
1.6	3ZZ-FE	1.6	2000.02 - 2002.01		4480.82D
1.6 16V	3ZZ-FE	1.6	2000.02 - 2001.11		4480.82D
1.8	7A-FE	1.8	1997.04 - 2002.06		3478.82D
1.9 D	1WZ	1.9	2000.02 - 2002.01		4446.83D
2.0 D	2C-E	2.0	1997.04 - 2000.02		4103.82D
2.0 D-4D	1CD-FTV	2.0	1997.04 - 2002.01		410231.82D
2.2 TD	3C-TE	2.2	1998.04 - 2001.10		3478.82D

### COROLLA (\_E12\_) 2001→

1.4 D	1ND-TV	1.4	2004.07 - 2007.02		410231.82D
1.4 D-4D	1ND-TV	1.4	2004.07 - 2007.07		410231.82D
1.4 VVT-i	4ZZ-FE	1.4	2002.01 - 2007.07		4480.82D
1.5	1NZ-FE	1.5	2001.11 - 2007.07		410231.82D
1.6	1ZR-FE	1.6	2006.11 - 2007.07		4480.82D
1.6 VVT-i	3ZZ-FE	1.6	2002.01 - 2007.07		4480.82D
1.8	1ZZ-FE	1.8	2001.03 - 2007.07		4480.82D
1.8 VVT-i	1ZZ-FE	1.8	2002.01 - 2007.02		4480.82D

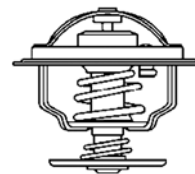

# TOYOTA

	Engine	Ltr.	Year	Restriction*	Thermostat
1.8 VVTL-i	2ZZ-GE	1.8	2002.01 - 2007.02		4480.82D
2.0 D-4D	1CD-FTV	2.0	2001.09 - 2007.07		410231.82D
<b>COROLLA (_E7_) 1979→1985</b>					
1.3	4K, 4K-C	1.3	1979.09 - 1987.08		3119.82D5
1.6	2T, 2T-G, 2TB	1.6	1979.09 - 1983.09		3119.82D5
1.8	3T, 3T-C	1.8	1979.09 - 1983.09		3119.82D5
1.8 D	1C	1.8	1983.01 - 1987.08		4103.82D
<b>COROLLA (_E8_) 1983→1989</b>					
1.3	2A-L, 2E, 2E-L, 2E-LC	1.3	1983.06 - 1987.08		4103.82D
1.5		1.5	1983.06 - 1987.07		4103.82D
1.6	4A-C, 4A-L, 4A-LC	1.6	1983.06 - 1989.06		4103.82D
1.6 16V	4A-C, 4A-GE, 4A-GE, 4A-GEL	1.6	1983.05 - 1987.08		4103.82D
1.8 D	1C, 1C-L	1.8	1983.06 - 1988.05		4103.82D
<b>COROLLA (_E9_) 1987→1994</b>					
1.3	2E	1.3	1987.05 - 1992.04		4103.82D
1.3 i	2E-E, 2E	1.3	1987.08 - 1992.12		4103.82D
1.5	3E, 3E-E, 3E-TE	1.5	1987.11 - 1992.04		4103.82D
1.6	4A-F, 4A-FE, 4A-GE	1.6	1987.07 - 1993.06		4103.82D
1.8 D	1C	1.8	1987.07 - 1993.06		4103.82D
<b>COROLLA LEVIN Coupe 1991→1997</b>					
1.5	5A-FE	1.5	1991.06 - 1997.08		3478.82D
1.6 GT	4A-FE	1.6	1991.06 - 1997.08		3478.82D
<b>COROLLA (ZER_, ZZE_) 2004→</b>					
1.5	1NZ-FE	1.5	2004.03 - 2009.03		410231.82D
1.6	3ZZ-FE	1.6	2004.04 - 2009.03		4480.82D
1.8	1ZZ-FE	1.8	2004.04 - 2009.03		4480.82D
2.0 D-4D	1CD-FTV	2.0	2004.04 - 2009.03		410231.82D
2.2 D-4D	2AD-FTV	2.2	2005.10 - 2009.03		4480.82D
<b>COROLLA (E14, E15)</b>					
1.4 D-4D	1ND-TV	1.4	2007.01 -		410231.82D
1.6	1ZR-FE, 1ZR-FAE	1.6	2009.01 -		4480.82D
1.6 Dual VVTi	1ZR-FE	1.6	2007.01 -		4480.82D
1.8 Flex	2ZR-FE	1.8	2007.07 - 2011.12		4480.82D
2.0 D-4D	1AD-FTV	2.0	2007.01 -		4480.82D
<b>CORONA 1987→1992</b>					
1.6	4A-F	1.6	1987.12 - 1989.10		3478.82D
2.0 D	2C	2.0	1987.12 - 1992.01		4103.82D
<b>CORONA 1992→1997</b>					
1.6	4A-FE	1.6	1992.02 - 1997.09		3478.82D
1.8	7A-FE	1.8	1992.02 - 1997.09		3478.82D
2.0	3S-FE, 3S-GE	2.0	1992.02 - 1997.09		4103.82D

# TOYOTA

Engine

Ltr.

Year

Restriction\*

Thermostat

## CORONA 1996→

2.0	3S-FE	2.0	1996.09 - 2001.05		3478.82D
-----	-------	-----	-------------------	--	----------

## CORSA

1.3	4E-FE	1.3	1990.10 - 1999.09		4103.82D
1.5	5E-FE	1.5	1994.11 - 1999.09		4103.82D
1.5 D	1N	1.5	1994.11 - 1999.09		4103.82D

## CRESSIDA (\_X6\_) 1980→1992

2.0	21R, 21R-C	2.0	1981.05 - 1985.03		3119.82
2.0 GLi	1G-E, 1G-FE	2.0	1982.08 - 1992.09		3478.82D
2.2 D	L	2.2	1981.10 - 1985.03		4126.88

## DYNA

2.0	3Y	2.0	1984.09 - 1987.08		4103.82D
2.0	1TR-FE	2.0	2006.09 -		410231.82D
2.0 LPG	1TR-FPE	2.0	2006.09 -		410231.82D
2.4 D	2J	2.4	1984.09 - 1987.08		3477.88D
2.5 D4d	2KD-FTV	2.5	2001.08 -		410181.82D
2.7	2TR-FE	2.7	2006.09 -		410231.82D
3.0 D4d	5L	3.0	2001.08 -		3477.88D
3.0 D4d	1KD-FTV	3.0	2006.09 -		410181.82D

## HIACE II

1.8	2Y	1.8	1983.03 - 1989.11		4103.82D
2.0	3Y	2.0	1984.01 - 1989.11		4103.82D
2.2	4Y	2.2	1987.09 - 1989.08		4103.82D
2.2 D	L	2.2	1983.03 - 1989.11		4126.88
2.4 D	2L	2.4	1984.05 - 1989.11		3477.88D

## HIACE III

2.0	1RZ	2.0	1989.08 - 1998.04		410178.82D
2.4	2RZ-E	2.4	1989.08 - 1995.08		410178.82D
2.4 D	2L	2.4	1989.08 - 1995.08		3477.88D
2.5 D-4D	2KD-FTV	2.5	2001.08 - 2004.08		410181.82D
3.0 D	5L	3.0	1998.08 - 2004.08		3477.88D

## HIACE IV

2.4	2RZ-E	2.4	1995.08 - 2005.02		410178.82D
2.4 D	2L	2.4	1995.08 - 2006.08		3477.88D
2.4 TD	2L-T	2.4	1995.08 - 2006.08		3477.88D
2.5 D-4D	2KD-FTV	2.5	2001.11 - 2006.08		410181.82D
2.7	3RZ-FE	2.7	1998.04 - 2006.08		410178.82D

## HIACE / COMMUTER IV

2.5 D-4D	2KD-FTV	2.5	2006.09 -		410181.82D
----------	---------	-----	-----------	--	------------

## HILUX II Pick-up

1.8	2Y	1.8	1988.08 - 1994.07		4103.82D
2.0	3Y	2.0	1984.01 - 1986.12		4103.82D
2.2	4Y	2.2	1987.01 - 1989.12		4103.82D
2.4 D	2L	2.4	1984.01 - 2005.07		3477.88D

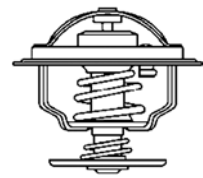

# TOYOTA

	Engine	Ltr.	Year	Restriction*	Thermostat
2.4 i	2RZ-FE	2.4	1997.08 - 2005.07		410178.82D
2.4 TD	2L-T	2.4	1998.08 - 2002.01		3477.88D
2.5 D-4D	2KD-FTV	2.5	2001.11 - 2005.07		410181.82D
2.7	3RZ-FE	2.7	2001.08 - 2004.07		410178.82D
<b>HILUX III Pick-up</b>	2KD-FTV	2.5	2005.08 -		410181.82D
2.5 D					
2.5 D-4D	2KD-FTV	2.5	2006.06 -		410181.82D
3.0	1KD-FTV	3.0	2005.08 - 2006.09		410181.82D
3.0 D	1KD-FTV	3.0	2006.10 -		410181.82D
3.0 D-4D	1KD-FTV	3.0	2007.12 -		410181.82D
<b>LAND CRUISER (_J7_) 1984→1996</b>					
	2L	2.4	1984.11 - 1985.10		3477.88D
2.4 D					
2.4 TD	2L-T	2.4	1985.10 - 1996.05		3477.88D
3.0 TD	1KZ-T	3.0	1993.05 - 1996.05		410181.82D
<b>LAND CRUISER (J12) 2002→</b>					
3.0 D-4D	1KD-FTV	3.0	2002.09 - 2010.02		410181.82D
<b>LAND CRUISER 80 (_J8_) 1990→1998</b>					
	1KZ-T	3.0	1990.01 - 1991.09		410181.82D
3.0 TD					
<b>LAND CRUISER 90 (_J9_) 1995→</b>					
3.0 D-4D	1KD-FTV	3.0	2000.10 -		410181.82D
3.0 TD (KZJ90_, KZJ95_)	1KZ-TE	3.0	1996.04 -		410181.82D
3.4 i 24V (VZJ90_, VZJ95_)	5VZ-FE	3.4	1996.04 -		4480.82D
<b>LAND CRUISER 150 (KDJ15_, GRJ15_)</b>					
	1KD-FTV	3.0	2010.01 -		410181.82D
3.0 D-4D					
<b>LITEACE (_M2_) 1979→1986</b>					
1.3	4K	1.3	1979.10 - 1985.09		3119.82D5
1.8 D	1C	1.8	1982.10 - 1985.09		3478.82D
<b>LITEACE (M2_) 1979→1986</b>					
1.3	4K, 4K-C	1.3	1979.10 - 1986.10		3119.88D5
<b>LITEACE (CM3_, KM3_) 1984→1992</b>					
	5K	1.5	1985.10 - 1992.01		3119.88
1.5					
2.0 D	2C	2.0	1988.08 - 1992.01		3478.82D
<b>LITEACE (_R2_LG) 1992→1998</b>					
2.0 D	2C	2.0	1992.01 - 1994.05		3478.82D
2.2	4Y-EC	2.2	1992.01 - 1995.01		3478.82D

**TOYOTA**

Engine

Ltr.

Year

Restriction\*

Thermostat

**MODELL F (\_R2\_,31)**

1.8	2Y-C, 2Y	1.8	1982.11 - 1984.08		4103.82D
2.0	3Y, 3Y-C	2.0	1984.08 - 1990.01		4103.82D
2.2	4Y-EC	2.2	1987.08 - 1990.01		4103.82D

**MR 2 I (\_W1\_)**

1.6 16V	4A-GEL, 4A-GELC	1.6	1984.11 - 1990.06		4103.82D
---------	-----------------	-----	-------------------	--	----------

**MR 2 II (\_W2\_)**

2.0	3S-FE	2.0	1989.12 - 1992.08		4480.82D
2.0 16V	3S-GE	2.0	1989.12 - 1993.11		4480.82D

**MR 2 III (\_W3\_)**

1.8 16V VT-i	1ZZ-FE	1.8	1999.10 - 2007.06		4480.82D
--------------	--------	-----	-------------------	--	----------

**PASEO (EL54)**

1.5	5E-FE	1.5	1996.10 - 1999.03		3478.82D
1.5 16V	5E-FE	1.5	1995.08 - 1999.07		3478.82D

**PICNIC (\_XM10)**

2.0	3S-FE	2.0	2001.01 - 2001.12		3478.82D
2.0 16V	3S-FE	2.0	1996.05 - 2001.12		3478.82D
2.2 D	3C-TE	2.2	1997.08 - 2001.12		3478.82D

**PREVIA (TCR1\_,TCR2\_)  
1990→2000**

2.4	2TZ-FE, 2TZ-FZE	2.4	1990.05 - 2000.08		410178.82D
-----	-----------------	-----	-------------------	--	------------

**PREVIA (ACR3) 2000→**

2.0 D-4D	1CD-FTV	2.0	2001.03 - 2006.01		410231.82D
2.4	2AZ-FE	2.4	2000.08 - 2006.01		4480.82D
3.0 VVTi	1MZ-FE	3.0	2000.08 - 2005.12		4480.82D
3.5	2GR-FE	3.5	2000.02 - 2006.01		4480.82D

**PREVIA III (ACR5\_, GSR5\_)**

2.4	2AZ-FE	2.4	2005.10 -		4480.82D
3.5	2GR-FE	3.5	2006.01 -		4480.82D

**PRIUS**

1.5	1NZ-FXE	1.5	2000.05 - 2009.03		410231.82D
-----	---------	-----	-------------------	--	------------

**RAV 4 I (SXA1\_)**

2.0	3S-FE	2.0	1994.06 - 2000.06		3478.82D
2.0 16V	3S-FE	2.0	1997.12 - 2000.06		3478.82D

**RAV 4 II (\_A2\_)**

1.8 VVTi	1ZZ-FE	1.8	2001.02 - 2005.11		4480.82D
2.0 D-4D	1CD-FTV	2.0	2001.09 - 2005.11		410231.82D
2.0 VVTi	1AZ-FE	2.0	2000.06 - 2005.11		4480.82D

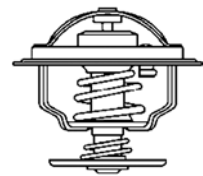

# TOYOTA

	Engine	Ltr.	Year	Einschränkung Restriction*	Thermostat
<b>RAV 4 III (ACA3_, ACE_, ALA3_, GSA3_, ZSA3_)</b>					
2.0	3ZR-FAE	2.0	2008.12 -		4480.82D
2.0 VVT-i	1AZ-FE, 3ZR-FAE	2.0	2006.03 -		4480.82D
2.2 D-4D	2AD-FHV, 2AD-FTV	2.2	2006.03 -		4480.82D
2.2 D-CAT	2AD-FHV	2.2	2006.03 -		4480.82D
2.4 VVTi	2AZ-FE	2.4	2005.11 -		4480.82D
3.5	2GR-FE	3.5	2007.08 -		4480.82D
3.5 VVTi	2GR-FE	3.5	2005.11 -		4480.82D
<b>STARLET (KP6) 1978→1984</b>					
1.0	2K	1.0	1978.02 - 1984.09		3119.82D5
1.2	3K-H	1.2	1978.02 - 1982.09		3119.82D5
1.3	4K	1.3	1982.08 - 1984.09		3119.82D5
<b>STARLET (_P7_) 1984→1989</b>					
1.0	1E-L	1.0	1984.10 - 1989.12		4103.82D
1.3	2E-LC	1.3	1984.10 - 1989.12		4103.82D
1.5 D	1N	1.5	1986.12 - 1989.12		4103.82D
<b>STARLET (_P8_) 1989→1996</b>					
1.3	2E	1.3	1989.12 - 1991.12		4103.82D
1.3 12V	2E-E, 2E	1.3	1989.12 - 1996.03		4103.82D
1.5 D	1N	1.5	1989.12 - 1996.03		4103.82D
<b>STARLET (EP91) 1996→1999</b>					
1.3	4E-FE	1.3	1996.04 - 1999.03		4103.82D
<b>SUPRA (JZA80)</b>					
3.0 i Bi-Turbo	2JZ-GTE	3.0	1993.05 - 2002.08		410231.82D
<b>TERCEL (_L1_, _L2_) 1979→1988</b>					
1.3	2A	1.3	1979.03 - 1988.01		4103.82D
1.45	3A-C	1.45	1983.08 - 1985.05		4103.82D
1.5	3A, 3A-C	1.5	1982.10 - 1988.01		4103.82D
<b>VENZA (GGV1_, AGV1_)</b>					
2.7	1AR-FE	2.7	2008.11 -		4480.82D
<b>VERSO (_AUR2_, _ZGR2_)</b>					
1.6	1ZR-FAE	1.6	2009.04 -		4480.82D
1.8	2ZR-FAE	1.8	2009.04 -		4480.82D
2.0 D-4D	1AD-FTV	2.0	2009.04 -		4480.82D
2.2 D-CAT	2AD-FHV	2.2	2009.04 -		4480.82D



**TOYOTA**

Engine

Ltr.

Year

Restriction\*

Thermostat

**YARIS (\_P1, P2, P9)**

1.0 16V	1SZ-FE	1.0	1999.04 - 2005.09		<b>410201.80D</b>
1.0 VVT-i	1KR-FE	1.0	2006.01 -		<b>410201.80D</b>
1.3	2NZ-FE, 2SZ-FE	1.3	1999.11 - 2005.09		<b>410231.82D</b>
1.3 16V	2NZ-FE	1.3	1999.11 - 2005.09		<b>410231.82D</b>
1.3 VVT-i	2SZ-FE	1.3	2006.01 -		<b>410201.80D</b>
1.33 VVT-i	1NR-FE	1.33	2009.03 -		<b>410201.80D</b>
1.4 D-4D	1ND-TV	1.4	2001.12 - 2005.09		<b>410231.82D</b>
1.5	1NZ-FE	1.5	2000.03 - 2005.09		<b>410231.82D</b>
1.5 VVT-i	1NZ-FE	1.5	2001.04 - 2005.09		<b>410231.82D</b>
1.8 VVTi	2ZR-FE	1.8	2007.01 - 2008.08		<b>4480.82D</b>

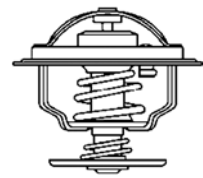

# VAUXHALL

	Engine	Ltr.	Year	Restriction*	Thermostat
<b>AGILA Mk I (A)</b>					
1.0 12V	Z 10 XE, Z 10 XEP	1.0	2000.02 - 2006.11		411579.92D ▲
1.2 16V	Z 12 XE	1.2	2000.09 - 2008.03		411579.92D ▲
1.2 16V Twinport	Z 12 XEP	1.2	2004.07 - 2006.11		411579.92D ▲
1.3 CDTI	Z 13 DT	1.3	2003.08 - 2008.03		410588.88D
<b>AGILA Mk II (B)</b>					
1.3 CDTI	D13A, Z 13 DTJ	1.3	2008.01 -		410588.88D
<b>ANTARA</b>					
2.4	Z 24 XED	2.4	2006.08 -		4189.87D
2.4	A 24 XE	2.4	2010.11 -		411193.82D
<b>ARENA</b>					
1.9 D	F8Q 600, F8Q 606	1.9	1998.03 - 2001.08	ohne Gehäuse	3470.89D50
1.9 D	F8Q 606, F8Q 600	1.9	1998.04 - 2001.08	mit Gehäuse	410530.89D
2.5 D	S8U 780, S8U 782, S8U 758	2.5	1998.03 - 2001.08		4151.76D
		1.2	1979.10 - 1984.08		3017.92D50
<b>ASTRA</b>					
1.2	12 S				
1.2 S	12 S	1.2	1982.02 - 1984.08		3017.92D50
1.3	13 S	1.3	1980.09 - 1984.08		3017.92D50
1.3 S	13 S	1.3	1979.09 - 1984.08		3017.92D50
1.6 D	16 D	1.6	1982.02 - 1986.08		4115.92D
1.6 S	16 S, 16 SH	1.6	1981.09 - 1986.08		3054.87D50
1.8 GTE	18 E	1.8	1983.03 - 1986.08		4255.82D
<b>ASTRA Mk II</b>					
1.2	12 S	1.2	1984.09 - 1991.08		3017.92D2
1.3	13 S	1.3	1984.09 - 1991.08		3017.92D2
1.4 i	C 14 NZ	1.4	1990.01 - 1991.12		3017.92D2
1.4 S	14 NV	1.4	1989.01 - 1991.08		3017.92D2
1.5 DT	15 DT	1.5	1987.01 - 1991.08		3468.88D
1.6	16 SV	1.6	1984.09 - 1991.08		3017.92D2
1.6	16 SH	1.6	1985.09 - 1991.08		4115.92D
1.6 D	16 DA	1.6	1984.09 - 1991.08		4115.92D
1.6 i	16 SV, C 16 NZ, C 16 LZ, E 16 NZ	1.6	1987.01 - 1993.08		3017.92D2
1.6 S	16 SH	1.6	1984.09 - 1986.08		4115.92D
1.6 S	16 S, 16 SV	1.6	1989.01 - 1991.12		3017.92D2
1.7 D	17 D, 17 DR	1.7	1989.01 - 1991.12		4115.92D
1.8	18 SE	1.8	1986.01 - 1990.12		4164.92D
1.8 GTE	18 SE, 18 E	1.8	1984.09 - 1991.08	ohne Gehäuse	4115.92D
1.8 GTE	18 SE, 18 E	1.8	1984.09 - 1991.08	mit Gehäuse	4164.92D
1.8 i	18 SE, 18 E	1.8	1985.09 - 1991.08	mit Gehäuse	4164.92D
1.8 i	18 E	1.8	1990.01 - 1991.08	ohne Gehäuse	4115.92D
1.9	C 20 XE	1.9	1988.03 - 1991.08		3017.92D2
2.0 GTE	20 SEH	2.0	1986.09 - 1991.08		4164.92D
2.0 GTE 16V	20 XE	2.0	1988.05 - 1991.08		4164.92D
2.0 i	20 NE, C 20 NE	2.0	1987.01 - 1993.08		4164.92D
<b>ASTRA Mk III</b>					
1.4 i	C 14 NZ, C 14 SE	1.4	1991.01 - 2001.03		3017.92D2
1.4 i 16V	X 14 XE	1.4	1996.01 - 2001.03		4178.92D
1.4 S	14 NV	1.4	1991.09 - 1998.02		3017.92D2

# Thermostats

## VAUXHALL

	Engine	Ltr.	Year	Restriction*	Thermostat
1.6	C 16 SE	1.6	1994.03 - 1995.08		4178.92D
1.6 i	C 16 NZ, C 16 SE, E 16 NZ, X 16 SZ, X 16 SZR	1.6	1991.01 - 2001.03		3017.92D2
1.6 i 16V	X 16 XEL	1.6	1994.01 - 1998.09		4178.92D
1.6 Si	C 16 SE	1.6	1991.03 - 1994.12		3017.92D2
1.7 D	17 D, 17 DR	1.7	1991.12 - 1998.02		4115.92D
1.7 TD	17 DT (TC4EE1)	1.7	1991.11 - 1998.09	Motor no. →731418	3468.88D
1.7 TD	17 DT (TC4EE1)	1.7	1991.12 - 1998.09	Motor no. 731419→	3467.85D
1.7 TD	X 17 DTL	1.7	1994.01 - 1998.09		4115.92D
1.8	C 18 XE	1.8	1994.09 - 1996.08	Chassis No. →01458051	4177.92D
1.8	C 18 XE	1.8	1994.10 - 1996.08	Chassis No. 01458052→	4183.92D
1.8 16V	X 18 XE, C 18 XEL	1.8	1994.11 - 2001.03	Chassis No. →01458051	4177.92D
1.8 16V	X 18 XE, C 18 XEL	1.8	1994.12 - 2001.03	Chassis No. 01458052→	4183.92D
1.8 i	C 18 NZ	1.8	1991.09 - 1998.09		4168.92D
1.8 i 16V	C 18 XE, C 18 XEL	1.8	1993.06 - 1998.02	Chassis No. →01458051	4177.92D
1.8 i 16V	C 18 XE, C 18 XEL	1.8	1993.07 - 1998.02	Chassis No. 01458052→	4183.92D
1.8 i 16V	X 18 XE, C 18 XEL	1.8	1994.09 - 1998.02	Chassis No. →01458051	4177.92D
1.8 i 16V	X 18 XE, C 18 XEL	1.8	1994.10 - 1998.03	Chassis No. 01458052→	4183.92D
2.0 i	C 20 NE	2.0	1991.09 - 1998.09		4168.92D
2.0 i 16V	C 20 XE	2.0	1991.09 - 1998.02		4164.92D
2.0 i 16V	X 20 XEV	2.0	1994.01 - 1998.09		4183.92D

## ASTRA Mk IV

1.2 16V	X 12 XE, Z 12 XE	1.2	1998.02 - 2005.05		4459.92D
1.4 16V	X 14 XE	1.4	1998.02 - 2005.05		4208.92D
1.4 16V	Z 14 XE	1.4	1998.02 - 2005.05		4242.92D
1.6	X 16 SZR, Z 16 SE	1.6	1998.02 - 2005.05		3017.92D2
1.6	Z 16 XEP	1.6	2002.12 - 2005.05		4431.105D
1.6 16V	X 16 XEL	1.6	1998.02 - 2005.05		4208.92D
1.6 16V	Z 16 XE	1.6	1998.02 - 2005.10		4242.92D
1.6 16V	C 16 SEL	1.6	1998.09 - 2005.05		3017.92D2
1.6 16V	Z 16 XEP	1.6	1998.09 - 2005.10		4431.105D
1.6 Dualfuel	Z 16 XE	1.6	1998.03 - 2005.05		4242.92D
1.6 i	X 16 SZR	1.6	1998.08 - 2000.09		3017.92D2
1.6 i	Z 16 SE	1.6	2000.09 - 2006.08		3017.92D2
1.7 TD	X 17 DTL	1.7	1998.02 - 2006.08		4115.92D
1.8 16V	Z 18 XE, Z 18 XEL, X 18 XE1	1.8	1998.02 - 2005.10		411578.92D ▲
1.8 16V Dualfuel	Z 18 XE	1.8	1998.02 - 2005.08		411578.92D ▲
2.0	X 20 XER, Z 20 LET	2.0	1999.10 - 2006.07		4183.92D
2.0 16V	X 20 XER, X 20 XEV	2.0	1998.02 - 2005.05		4183.92D
2.0 16V Turbo	Z 20 LET	2.0	2000.09 - 2005.08		4183.92D
2.0 DI	X 20 DTL, Y 20 DTL	2.0	1998.02 - 2006.08		4198.92D
2.0 DTI	Y 20 DTH	2.0	2004.04 - 2006.08	Motor no. →17B49754, → 2(2/5/6/8/B/H) 999999	4198.92D
2.0 DTI	Y 20 DTH	2.0	2004.05 - 2006.09	Motor no. 17B49755→	4428.92D
2.0 DTI 16V	Y 20 DTH	2.0	1998.02 - 2005.05	Motor no. →17B49754, → 2(2/5/6/8/B/H) 999999	4198.92D

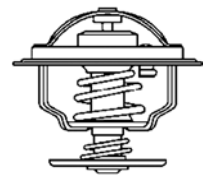

# VAUXHALL

	Engine	Ltr.	Year	Restriction*	Thermostat
2.0 DTI 16V	Y 20 DTH	2.0	1998.04 - 2005.05	Motor no. 17B49755→, 3(2/5/6/8/B/H) 999999 →	4428.92D
2.0 SRI Turbo	Z 20 LET	2.0	2002.07 - 2005.05		4183.92D
2.0 Turbo	Z 20 LET	2.0	2002.03 - 2005.10		4183.92D
2.2 16V	Z 22 SE	2.2	2000.03 - 2005.10		411193.82D
2.2 DTI	Y 22 DTR	2.2	2002.09 - 2005.05		4433.92D
<b>ASTRA Mk V</b>					
1.2	Z 12 XEP	1.2	2005.08 - 2010.10		4459.92D
1.3 CDTI	Z 13 DTH	1.3	2004.01 - 2010.11		410048.88D
1.4	Z 14 XEL, Z 14 XEP	1.4	2004.01 - 2010.11		4459.92D
1.4 i	Z 14 XEP	1.4	2005.03 -		4459.92D
1.4 i 16V	Z 14 XEP	1.4	2005.03 - 2010.11		4459.92D
1.6	Z 16 XE1, Z 16 XEP, Z 16 XER	1.6	2004.01 - 2010.11		4431.105D
1.6	Z 16 LET	1.6	2004.08 - 2010.11		4357.92D
1.6 i 16V	Z 16 XER	1.6	2006.10 - 2010.11		4431.105D
1.8	Z 18 XE	1.8	2004.01 - 2010.11		411578.92D ▲
1.8	Z 18 XER, A 18 XER	1.8	2004.01 - 2010.11		4431.105D
1.8 i 16V	Z 18 XER, A 18 XER	1.8	2007.03 - 2010.11		4431.105D
1.9 CDTI	Z 19 DT, Z 19 DTH, Z 19 DTJ, Z 19 DTL	1.9	2004.01 - 2011.11		410049.88D
1.9 CDTI 16V	Z 19 DTJ	1.9	2004.01 - 2009.05		410049.88D
2.0	Z 20 LEL	2.0	2006.02 - 2010.11		4183.92D
2.0 Turbo	Z 20 LEH, Z 20 LEL, Z 20 LER	2.0	2004.01 - 2011.11		4183.92D
2.0 VXR	Z 20 LEH	2.0	2009.02 - 2010.11		4183.92D
<b>ASTRA Mk VI (J)</b>					
1.6	A 16 XER, A 16 LET	1.6	2009.12 -		411059.105D ▲
1.6 Turbo	A 16 LET	1.6	2009.12 -		411059.105D ▲
2.0 VXR	A 20 NFT	2.0	2012.04 -		411193.82D
<b>CALIBRA</b>					
2.0 i	C 20 NE	2.0	1990.06 - 1997.07		4144.92D
2.0 i 16V	C 20 XE	2.0	1990.06 - 1994.02		4164.92D
2.0 i 16V	X 20 XEV	2.0	1990.06 - 1997.07		4183.92D
2.0 i Turbo	C 20 LET	2.0	1992.03 - 1997.07		4164.92D
2.5 i V6	X 25 XE, C 25 XE	2.5	1993.04 - 1997.07		4175.92D
<b>CARLTON Mk II</b>					
1.8 S	18 S	1.8	1982.11 - 1986.08		4115.92D
2.0	20 E	2.0	1977.09 - 1986.08		4255.87D
2.0 i	20 E	2.0	1983.01 - 1984.12		4255.87D
2.0 S	C 20 NEJ	2.0	1978.10 - 1986.08		4144.92D
2.2 i	22 E	2.2	1984.11 - 1986.08		4255.92D
2.3 D	23 D	2.3	1983.05 - 1986.08		4255.92D
<b>CARLTON Mk III</b>					
1.8	S 18 NV	1.8	1986.09 - 1988.08		4115.92D
1.8	18 NV, 18 SEH, 18 SV, E 18 NVR	1.8	1986.09 - 1994.03		4144.92D
2.0	C 20 NE, C 20 NEF, C 20 NEJ	2.0	1986.09 - 1994.03		4144.92D
2.0 i	20 SE, C 20 NEJ	2.0	1986.09 - 1994.03		4144.92D
2.2 TD	23 YDT	2.2	1986.09 - 1988.08		4255.92D
2.3 D	23 YD	2.3	1986.09 - 1994.03		4255.92D

# Thermostats

## VAUXHALL

	Engine	Ltr.	Year	Restriction*	Thermostat
2.3 TD Interc.	23 DTR	2.3	1988.08 - 1994.03		4255.92D
2.4 i	C 24 NE	2.4	1988.09 - 1994.03		4255.92D
2.6 i	C 26 NE	2.6	1990.09 - 1994.03		4255.92D
3.0	C 30 NE	3.0	1987.03 - 1994.03		4255.92D
3.0 24V	C 30 SEJ	3.0	1989.09 - 1994.03		4255.92D
3.0 3000	30 NE	3.0	1987.03 - 1990.09		4255.92D
3.0 3000 24V	C 30 SE	3.0	1989.09 - 1994.03		4255.92D
3000	C 30 LE	3.0	1987.03 - 1994.03		4255.92D
3000 24V	C 30 SEJ	3.0	1989.09 - 1994.03		4255.92D

### CAVALIER Mk II

1.3	13 N, 13 NB, 13 S	1.3	1981.09 - 1988.08		3017.92D2
1.6	16 SH	1.6	1983.10 - 1988.08		4164.92D
1.6 D	16 D, 16 DA	1.6	1982.03 - 1988.08		4115.92D
1.6 i	C 16 NZ, C 16 LZ, E 16 NZ	1.6	1986.08 - 1988.08		3017.92D2
1.6 N	16 N	1.6	1981.09 - 1988.08		4164.92D
1.6 S	16 SH	1.6	1981.09 - 1988.08		4164.92D
1.8	E 18 NV	1.8	1986.08 - 1988.08		4164.92D
1.8 i	18 E, 18 SE	1.8	1981.09 - 1988.08		4164.92D
1.8 i	C 18 NE	1.8	1985.01 - 1986.08		4115.92D
1600D	16 DA, 16 D	1.6	1982.03 - 1988.08		4115.92D
1800i	18 SE	1.8	1985.03 - 1988.10		4115.92D
2.0	20 E	2.0	1986.08 - 1987.08		4144.92D
2.0	20 S	2.0	1986.09 - 1987.08		3021.88D50
2.0 i	20 NE, C 20 NE	2.0	1986.09 - 1988.08		4164.92D
2.0 SRi 130	20 SEH	2.0	1987.03 - 1988.08		4164.92D
2000i	20 SE	2.0	1986.09 - 1988.08		4164.92D

### CAVALIER Mk III

1.4 S	14 NV	1.4	1988.09 - 1995.11		3017.92D2
1.6	16 SV	1.6	1988.09 - 1993.05		3017.92D2
1.6 i	E 16 NZ, X 16 SZ	1.6	1988.09 - 1995.11		3017.92D2
1.7 D	17 D, 17 DR	1.7	1988.09 - 1995.11		4115.92D
1.7 TD	17 DT (TC4EE1)	1.7	1988.09 - 1995.11	Motor no. →731418	3468.88D
1.7 TD	17 DT (TC4EE1)	1.7	1988.10 - 1995.11	Motor no. 731419→	3467.85D
1.8	C 18 NZ, 18 SV	1.8	1988.09 - 1995.08		4144.92D
1.8 i	C 18 NZ	1.8	1990.03 - 1995.11		4144.92D
2.0 i	20 NE, 20 SEH, 20 XE, C 20 NE	2.0	1988.09 - 1995.11		4164.92D
2.0 i 16V	C 20 XE	2.0	1988.09 - 1995.11		4164.92D
2.0 i 16V	X 20 XEV	2.0	1993.09 - 1995.11		4183.92D
2.0 i Turbo	C 20 LET	2.0	1992.06 - 1994.11		4164.92D
2.0 SRi	20 SEH	2.0	1988.09 - 1992.09		4164.92D
2.0 SRi 16V	X 20 XEV	2.0	1993.09 - 1995.11		4183.92D
2.5 V6	C 25 XE	2.5	1988.08 - 1994.06		4175.92D

### CHEVETTE

1.2	13 N	1.2	1976.09 - 1985.12		3017.92D50
1300	13 N, 13 S	1.3	1975.03 - 1985.12		3017.92D50

### COMBO Mk I

1.2	C 12 NZ, X 12 SZ	1.2	1994.07 - 2001.10		3017.92D2
1.4	C 14 NZ, C 14 SE	1.4	1994.07 - 2001.10		3017.92D2
1.7 D	17 D (4EE1), X 17 D (4EE1)	1.7	1994.07 - 2001.10	Motor no. →334922	3467.85D

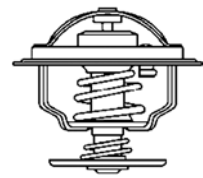

# VAUXHALL

	Engine	Ltr.	Year	Restriction*	Thermostat
<b>COMBO Mk II</b>					
1.3 CDTI 16V	Y 13 DT, Z 13 DT, Z 13 DTJ	1.3	2004.09 - 2012.02		<b>410588.88D</b>
1.4	Z 14 XEP	1.4	2004.10 - 2010.09		<b>4459.92D</b>
1.4 16V	Z 14 XE	1.4	2001.10 - 2007.05		<b>4242.92D</b>
1.4 16V	Z 14 XEP	1.4	2004.01 - 2011.11		<b>4459.92D</b>
1.6	Z 16 SE	1.6	2001.08 - 2011.11		<b>3017.92D2</b>
1.6 CNG	Z 16 YNG	1.6	2006.06 - 2010.09		<b>4242.92D</b>
1.6 CNG 16V	Z 16 YNG	1.6	2005.04 - 2012.02		<b>4242.92D</b>
<b>CORSA Mk I</b>					
1.0 i 12V	X 10 XE	1.0	1996.11 - 2000.09		<b>4459.92D</b>
1.2 i	C 12 NZ, X 12 SZ	1.2	1993.03 - 2000.09		<b>3017.92D2</b>
1.2 i 16V	X 12 XE	1.2	1998.03 - 2000.09		<b>4459.92D</b>
1.4 i	C 14 NZ, X 14 SZ	1.4	1993.03 - 2000.09		<b>3017.92D2</b>
1.4 i 16V	X 14 XE	1.4	1994.09 - 2000.09		<b>4178.92D</b>
1.4 i S	C 14 SE	1.4	1993.03 - 2000.09		<b>3017.92D2</b>
1.5 D	15 D	1.5	1993.03 - 2000.09	Motor no. →544012	<b>3468.88D</b>
1.5 D	15 D	1.5	1993.04 - 2000.09	Motor no. 544013 →	<b>3467.85D</b>
1.5 TD	X 15 DT (T4EC1), 15 DT (T4EC1)	1.5	1993.03 - 1996.10	Motor no. →544012	<b>3468.88D</b>
1.5 TD	X 15 DT (T4EC1), 15 DT (T4EC1)	1.5	1993.04 - 1996.10	Motor no. 544013 →	<b>3467.85D</b>
1.6 i 16V	C 16 XE, X 16 XE	1.6	1993.03 - 2000.09		<b>4178.92D</b>
1.7 D	17 D (4EE1), X 17 D (4EE1)	1.7	1996.02 - 2000.09	Motor no. →334922	<b>3467.85D</b>
<b>CORSA Mk II</b>					
1.0 12V	Z 10 XE, Z 10 XEP	1.0	2000.09 - 2003.10		<b>4459.92D</b>
1.2 16V	Z 12 XE	1.2	2000.09 - 2006.10		<b>4459.92D</b>
1.2 16V Dualfuel	Z 12 XE	1.2	2001.08 - 2006.10		<b>4459.92D</b>
1.2 Twinport	Z 12 XEP	1.2	2004.07 - 2006.10		<b>4459.92D</b>
1.3 CDTI 16V	Z 13 DT	1.3	2000.08 - 2006.09		<b>410588.88D</b>
1.3 CDTI 16V	Z 13 DTJ	1.3	2005.09 - 2006.09		<b>410048.88D</b>
1.4 16V	Z 14 XE	1.4	2000.09 - 2006.10		<b>4242.92D</b>
1.4 Twinport	Z 14 XEP	1.4	2003.06 - 2006.10		<b>4459.92D</b>
1.6 CNG	Y 16 YNG, Z 16 YNG	1.6	2003.05 - 2006.10		<b>4242.92D</b>
1.8 16V	Z 18 XE	1.8	2000.08 - 2006.09		<b>411578.92D ▲</b>
<b>CORSA Mk III</b>					
1.0	Z 10 XEP, A 10 XEP	1.0	2006.11 -		<b>4459.92D</b>
1.0 i 12V	A 10 XEP	1.0	2010.06 -		<b>4459.92D</b>
1.2	Z 12 XEP	1.2	2006.11 -		<b>4459.92D</b>
1.2 LPG	Z 12 XEP	1.2	2009.09 -		<b>4459.92D</b>
1.3 CDTI	A 13 DTC, Z 13 DTH, Z 13 DTJ	1.3	2006.11 -		<b>410048.88D</b>
1.4	Z 14 XEP	1.4	2006.07 -		<b>4459.92D</b>
1.4 LPG	Z 14 XEP	1.4	2006.07 -		<b>4459.92D</b>
1.6 VXR	A 16 LER, Z 16 LER	1.6	2007.02 -		<b>4357.92D</b>
<b>CORSAVAN Mk I</b>					
1.4 i	C 14 NZ	1.4	1994.01 - 2000.09		<b>3017.92D2</b>
1.5 D	15 D	1.5	1994.08 - 1995.12	Motor no. 544013 →	<b>3467.85D</b>
1.5 D	15 D	1.5	1994.09 - 1995.12	Motor no. →544012	<b>3468.88D</b>
1.7 D	17 D (4EE1), X 17 D (4EE1)	1.7	1994.01 - 2000.09	Motor no. →334922	<b>3467.85D</b>

# VAUXHALL

	Engine	Ltr.	Year	Restriction*	Thermostat
<b>CORSAVAN Mk II</b>					
1.2 16V	Z 12 XE	1.2	2000.09 - 2006.06		4459.92D
1.2 16V Dualfuel	Z 12 XE	1.2	2001.08 - 2006.06		4459.92D
1.3 CDTI 16V	Z 13 DT	1.3	2004.04 - 2006.06		410588.88D
1.4	Z 14 XEP	1.4	2003.11 - 2006.06		4459.92D
<b>CORSAVAN Mk III</b>					
1.2	Z 12 XEP	1.2	2009.07 -		4459.92D
1.3 CDTI	Z 13 DTH, Z 13 DTJ	1.3	2006.07 -		410048.88D
<b>FRONTERA Mk I (A)</b>					
2.0	C 20 NE, X 20 SE	2.0	1995.04 - 1998.08		4144.92D
2.0 i	C 20 NE, X 20 SE	2.0	1992.03 - 1998.10		4144.92D
2.2 i	X 22 XE	2.2	1995.03 - 1998.10		4177.92D
2.3 TD	23 DTR	2.3	1991.09 - 1998.06		4255.92D
2.4 i	C 24 NE	2.4	1992.03 - 1998.10		4255.92D
2.5 TDS	25TDS (VM41B)	2.5	1991.11 - 1998.10		4158.80D
FRONTERA Mk II (B)	X 22 DTH, Y 22 DTH	2.2	1998.10 - 2004.09		4207.92D
2.2 DTI					
2.2 i	X 22 SE, Y 22 SE	2.2	1998.10 - 2004.10		4177.92D
3.2 i	Y 32 NE, 6 VD1	3.2	1998.10 - 2004.10		4144.92D
<b>INSIGNIA</b>					
1.6	A 16 XER	1.6	2008.07 -	Chassis No. →91999999	4431.105D
1.6	A 16 XER	1.6	2008.08 -	Chassis No. A1000001→	411059.105D ▲
1.6 Turbo	A 16 LET	1.6	2009.01 -		4357.92D
1.8	A 18 XER	1.8	2008.07 - 2013.09	Chassis No. →91999999	4431.105D
1.8	A 18 XER	1.8	2008.08 - 2013.09	Chassis No. A1000001→	411059.105D ▲
2.0 Turbo	A 20 NFT, A 20 NHT	2.0	2008.07 -		411193.82D
<b>MAGNUM</b>					
1.8		1.8	1973.01 - 1981.01		3004.88D1
2.3		2.3	1973.01 - 1981.01		3004.88D1
<b>MERIVA Mk I (A)</b>					
1.3 CDTI	Y 13 DT, Z 13 DT, Z 13 DTJ	1.3	2003.01 - 2010.06		410588.88D
1.4 16V Twinport	Z 14 XEP	1.4	2003.01 - 2009.10		4459.92D
1.6 i	Z 16 SE	1.6	2003.01 - 2010.06		3017.92D2
1.6 i 16V	Z 16 XE	1.6	2003.01 - 2005.09		4242.92D
1.6 i 16V Twinport	Z 16 XEP	1.6	2003.05 - 2010.06		4431.105D
1.6 Turbo	Z 16 LET	1.6	2006.05 - 2010.06		4357.92D
1.8 i 16V	Z 18 XE	1.8	2003.05 - 2005.08		411578.92D ▲
<b>MOKKA</b>					
1.6	A 16 XER	1.6	2012.06 -		411059.105D ▲
<b>MOVANO</b>					
1.9 DTI	F9Q 770	1.9	2000.09 - 2001.10	Motor no. 000529→	3470.89D50
1.9 DTI	F9Q 774	1.9	2001.10 - 2010.05		410517.83D

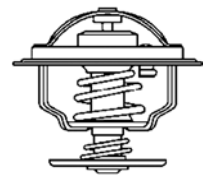

# VAUXHALL

	Engine	Ltr.	Year	Restriction*	Thermostat
2.5 D	S8U 770	2.5	1998.10 - 2000.09		4174.79D
2.8 DTI	S9W 702	2.8	1998.10 - 2001.10		4174.79D
<b>NOVA</b>					
1.0	10 S	1.0	1982.09 - 1993.03		3017.92D2
1.2	12 NV	1.2	1990.01 - 1994.10		3017.92D2
1.2 i	12 NC, C 12 NZ, E 12 GV	1.2	1985.01 - 1993.03		3017.92D2
1.2 N	12 NC, 12 NV, E 12 GV	1.2	1985.01 - 1993.03		3017.92D2
1.2 S	12 S, 12 ST	1.2	1982.09 - 1990.02		3017.92D2
1.3 i	13 NB, C 13 N	1.3	1985.09 - 1993.03		3017.92D2
1.3 S	13 SB	1.3	1982.09 - 1989.10		3017.92D2
1.4	14 NV, C 14 NZ, C 14 SE	1.4	1990.09 - 1993.03		3017.92D2
1.4 i	C 14 NZ	1.4	1990.01 - 1993.03		3017.92D2
1.4 i S	C 14 SE	1.4	1991.09 - 1993.03		3017.92D2
1.4 S	14 NV	1.4	1990.01 - 1993.03		3017.92D2
1.5 D	15 D	1.5	1987.09 - 1994.10		3468.88D
1.5 TD	15 DT (T4EC1)	1.5	1990.01 - 1993.03		3468.88D
1.6	E 16 SE	1.6	1988.09 - 1990.08		3017.92D2
1.6 GSI	C 16 SE, C 16 SEI, E 16 SE	1.6	1988.05 - 1993.03		3017.92D2
<b>OMEGA</b>					
2.0	20 SE, X 20 SE	2.0	1994.03 - 1999.09		4144.92D
2.0 16V	X 20 XEV	2.0	1994.03 - 2001.02		4183.92D
2.0 DTI 16V	X 20 DTH	2.0	1998.01 - 2000.09		4188.92D
2.2 16V	Y 22 XE, Z 22 XE	2.2	1994.01 - 2003.06		4183.92D
2.2 DTI 16V	Y 22 DTH	2.2	2000.08 - 2003.07		4188.92D
2.5 DTI 24V	Y 25 DT	2.5	2001.09 - 2003.07		4237.80D
2.5 TD	25 DT, X 25 DT	2.5	1994.04 - 2001.07		4237.80D
2.5 V6	X 25 XE	2.5	1994.03 - 2000.09		4175.92D
2.6 V6	Y 26 SE	2.6	2000.08 - 2003.07	Motor no. →11999999	4175.92D
3.0 V6	X 30 XE	3.0	1994.04 - 2000.07	Motor no. →11999999	4175.92D
3.2 V6	Y 32 SE	3.2	2001.02 - 2003.07	Motor no. →11999999	4175.92D
<b>ROYALE</b>					
2.0 E	H 20 E	2.0	1983.03 - 1984.10		4255.87D
2.2 E	22 E	2.2	1984.11 - 1987.08		4255.87D
2.2 TD	23 TD	2.2	1984.11 - 1987.08		4255.92D
2.5	25 S	2.5	1978.05 - 1980.12		3054.92D50
2.5 E	25 E, H 25 E	2.5	1983.01 - 1987.08		4255.87D
2.8	28 H	2.8	1978.02 - 1982.10		3054.92D50
2.9	30 E, 30 H, C 30 LE	2.9	1978.02 - 1987.08		4255.92D
2.9 E	30 E	2.9	1978.02 - 1986.12		4255.92D
3.0	30 E	3.0	1979.10 - 1982.10		4255.92D
<b>SENATOR</b>					
2.5 i	25 E	2.5	1984.09 - 1990.10		4255.87D
2.6 i	C 26 NE	2.6	1990.09 - 1993.09		4255.92D
3.0	30 NE, C 30 LE	3.0	1987.09 - 1993.09		4255.92D
3.0 24V	C 30 SE	3.0	1989.09 - 1993.09		4255.92D
3.0 i	30 E, C 30 NE	3.0	1984.09 - 1993.09		4255.92D



# VAUXHALL

	Engine	Ltr.	Year	Restriction*	Thermostat
<b>SIGNUM</b>					
1.8	Z 18 XE	1.8	2003.06 - 2005.07		411578.92D ▲
1.8	Z 18 XER	1.8	2005.08 - 2008.05		4431.105D
1.9 CDTI	Z 19 DT	1.9	2004.04 - 2008.03		410049.88D
1.9 CDTI 16V	Z 19 DTH	1.9	2004.04 - 2008.03		410049.88D
1.9 Turbo	Z 19 DTL	1.9	2005.01 - 2008.05		410049.88D
2.0 DTI	Y 20 DTH	2.0	2003.05 - 2008.05		4297.92D
2.0 i Turbo	Z 20 NET	2.0	2002.01 - 2008.10		411193.82D
2.2 DTI	Y 22 DTR	2.2	2003.05 - 2008.05		4297.92D
2.2 i	Z 22 YH	2.2	2003.05 - 2008.05		411193.82D
3.2 V6	Z 32 SE	3.2	2003.05 - 2008.05		4175.92D
<b>SINTRA</b>					
2.2 i 16 V	X 22 XE	2.2	1996.11 - 1999.04		4183.92D
3.0 i 24V	X 30 XE	3.0	1996.11 - 1999.04		4175.92D
<b>SPEEDSTER</b>					
VXR20	Z 20 LET	2.0	2001.03 - 2006.09		4183.92D
<b>TIGRA Mk I (F07)</b>					
1.4 16V	X 14 XE	1.4	1994.07 - 2000.12		4178.92D
1.6 16V	X 16 XE	1.6	1994.07 - 2000.12		4178.92D
<b>TIGRA TwinTop</b>					
1.3 CDTI	Z 13 DT	1.3	2004.06 - 2009.08		410588.88D
1.4	Z 14 XEP	1.4	2004.06 - 2009.08		4178.92D
1.8	Z 18 XE	1.8	2004.06 - 2009.08		411578.92D ▲
<b>VECTRA</b>					
1.6 i	X 16 SZR	1.6	1995.08 - 2002.03		3017.92D2
1.6 i 16V	X 16 XEL	1.6	1995.08 - 2002.03		4178.92D
1.6 i 16V	Y 16 XE, Z 16 XE	1.6	1995.08 - 2002.03		4242.92D
1.7 TD	X 17 DT (TC4EE1)	1.7	1995.10 - 1997.12		3467.85D
1.8 i 16V	X 18 XE	1.8	1995.10 - 2000.09		4183.92D
2.0 DI 16V	X 20 DTL	2.0	1995.08 - 2001.10		4188.92D
2.0 DTI 16V	Y 20 DTH, X 20 DTH	2.0	1995.08 - 2001.10		4201.92D
2.0 i	20 NEJ	2.0	1995.10 - 2002.03		4144.92D
2.0 i 16V	X 20 XEV	2.0	1995.10 - 2001.01		4183.92D
2.2 DTI 16V	Y 22 DTR	2.2	1995.08 - 2001.10		4201.92D
2.2 i 16V	Z 22 SE	2.2	1995.08 - 2003.07		411193.82D
2.5 i GSi	X 25 XE	2.5	1998.03 - 2000.07		4175.92D
2.5 i V6	X 25 XE	2.5	1995.09 - 2000.08		4175.92D
2.6 i V6	Y 26 SE	2.6	2000.09 - 2003.07	Motor no. →11162841 →17080724	4175.92D
<b>VECTRA MK II</b>					
1.6	Z 16 XEP	1.6	2006.01 - 2008.07		4431.105D
1.6 16V	Z 16 XE	1.6	2004.06 - 2008.07		4242.92D
1.8	Z 18 XEL	1.8	2002.04 - 2008.07		411578.92D ▲
1.8	Z 18 XER	1.8	2006.01 - 2008.07		4431.105D
1.8 16V	Z 18 XE	1.8	2002.04 - 2008.07		411578.92D ▲
1.8 16V Dualfuel	Z 18 XE	1.8	2002.04 - 2008.07		411578.92D ▲
1.9 CDTI	Z 19 DT, Z 19 DTL	1.9	2002.04 - 2008.09		410049.88D

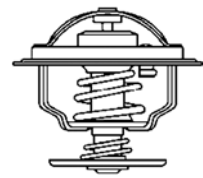

# VAUXHALL

	Engine	Ltr.	Year	Restriction*	Thermostat
1.9 CDTI 16V	Z 19 DTH	1.9	2004.04 - 2008.08		410049.88D
2.0 16V Turbo	Z 20 NET	2.0	2000.01 - 2008.10		411193.82D
2.0 DTI 16V	Y 20 DTH	2.0	2002.04 - 2008.10		4297.92D
2.2 16V	Z 22 SE	2.2	2002.01 - 2008.10		411193.82D
2.2 direct	Z 22 YH	2.2	2002.01 - 2008.10		411193.82D
2.2 DTI 16V	Y 22 DTR	2.2	2002.04 - 2008.10		4297.92D
3.2 V6	Z 32 SE	3.2	2002.08 - 2008.07		4175.92D
<b>VIVARO</b>					
1.9 DI	F9Q 762	1.9	2001.08 - 2006.12	Chassis No. →1Y799999 →1V699999	410517.89D
1.9 DI	F9Q 762	1.9	2001.09 - 2006.12	Chassis No. 2Y700001→ 2V600001→	410517.83D
1.9 DTI	F9Q 760	1.9	2001.08 - 2006.12		410517.83D
2.0 16V	F4R 720	2.0	2001.08 - 2006.07	Deckel Thermostatgehäuse	126104 ▲
2.0 16V	F4R 720	2.0	2001.08 - 2006.07		3466.89D
2.0 CDTI	M9R	2.0	2006.01 -		411476.83D ▲
2.0 ECOTEC	F4R 820	2.0	2006.08 -		3466.89D
<b>VX 220</b>					
2.0 i Turbo	Z 20 LET	2.0	2001.03 - 2004.04		4183.92D
2.2 i	Z 22 SE	2.2	2000.09 - 2005.07		411193.82D
<b>ZAFIRA Mk I (A)</b>					
1.6 16V	Z 16 XE, X 16 XEL	1.6	1999.04 - 2005.08		4208.92D
1.6 CNG	Z 16 YNG	1.6	2001.09 - 2005.06		4242.92D
1.8 16V	X 18 XE1, Z 18 XE	1.8	1999.05 - 2005.08		411578.92D ▲
1.8 Dualfuel	Z 18 XE	1.8	2000.09 - 2005.08		411578.92D ▲
2.0	Z 20 LET	2.0	2002.06 - 2005.06		4183.92D
2.0 DI 16V	X 20 DTL	2.0	1999.10 - 2005.08		4198.92D
2.0 DTI 16V	Y 20 DTH	2.0	1999.04 - 2005.08	Motor no. →17B49754, → 2(2/5/6/8/B/H) 999999	4428.92D
2.0 DTI 16V	Y 20 DTH	2.0	1999.05 - 2005.08	Motor no. 17B49755→, 3(2/5/6/8/B/H) 999999 →	4428.92D
2.0 GSI Turbo	Z 20 LET	2.0	2001.09 - 2005.06		4183.92D
2.2 16V	Z 22 SE	2.2	1998.11 - 2004.08		411193.82D
2.2 D	Y 22 DTR	2.2	2001.06 - 2005.06		4433.92D
<b>ZAFIRA Mk II (B)</b>					
1.6	A 16 XER, Z 16 XE1, Z 16 XEP, Z 16 XER	1.6	2005.07 -		4431.105D
1.6 CNG	Z 16 YNG	1.6	2005.07 -		4242.92D
1.8	Z 18 XER, A 18 XER	1.8	2005.04 -		4431.105D
1.9 CDTI	Z 19 DT, Z 19 DTH, Z 19 DTL	1.9	2005.07 -		410049.88D
2.0	Z 20 LEH, Z 20 LER	2.0	2005.07 -		4183.92D
2.2	Z 22 YH	2.2	2005.07 -		411193.82D
<b>ZAFIRA Mk III (P12)</b>					
1.6 CNG	A 16 XNT	1.6	2011.10 -		411059.105D ▲
1.8	A 18 XER, A 18 XEL	1.8	2011.10 -		411059.105D ▲

# VOLKSWAGEN

	Engine	Ltr.	Year	Restriction*	Thermostat
<b>BEETLE (9C1, 1C1)</b>					
1.4	BCA	1.4	2001.11 -	mit Gehäuse	410475.87D
1.6	AWH ,AYD, BFS	1.6	1999.10 -		3141.87D
1.8 T	AWV, APH, AVC, AGU, AWU, BKF, AWP, BNU	1.8	1999.10 -		3141.87D
1.9 TDI	ALH, BEW, ATD, BSW	1.9	1998.01 - 2004.06		4264.87D
2.0	APK, AZJ, AVH, AQY, AEG, BEV, BHP, BER, AZG, CBPA, BEJ	2.0	1998.01 -		3141.87D
2.3 V5	AQN	2.3	2000.10 -		4123.80D
2.5	BPS, BPR	2.5	2005.07 -		4488.80D0
<b>BEETLE Cabriolet (1Y7)</b>					
1.4	BCA	1.4	2003.01 - 2010.09	mit Gehäuse	410475.87D
1.6	BFS	1.6	2003.01 - 2010.09		3141.87D
1.8 T	AWV, AWU, BKF	1.8	2003.01 - 2010.09		3141.87D
1.9 TDI	AXR, BSW	1.9	2003.06 - 2010.09		4264.87D
2.0	AZJ, BEV, BDC, BGD	2.0	2002.09 - 2010.10		3141.87D
2.5	BPS, BPR	2.5	2005.07 - 2010.09		4488.80D0
<b>BEETLE (5C1)</b>					
1.6 TDI	CAYC	1.6	2011.10 -		410845.92D
2.0 TDI	CFFB, CJAA	2.0	2011.04 -		410845.87D
2.5	CCCA, CBUA, CBTA	2.5	2011.04 -		4488.80D0
<b>BEETLE Cabriolet (5C7)</b>					
1.6 TDI	CAYC	1.6	2012.12 -		410845.92D
2.0 TDI	CFFB	2.0	2012.12 -		410845.87D
<b>BORA</b>					
1.4 16V	AHW, AXP, BCA, APE, AKQ	1.4	2000.03 - 2005.05	mit Gehäuse	410989.87D
1.6	AEH, AKL	1.6	1998.10 - 2005.05		3141.87D
1.6 16V	AUS, ATN, BCB, AZD	1.6	2000.02 - 2005.05	mit Gehäuse	410989.87D
1.8	AGN	1.8	1999.02 - 2005.05		3141.87D
1.8 T	AGU, AUM	1.8	2000.05 - 2005.05		3141.87D
1.8 T	AUQ	1.8	2002.03 - 2005.05		3141.87D
1.9 SDI	AGP, AQM	1.9	1998.10 - 2005.05		4264.87D
1.9 TDI	AGR, ALH, AHF, ASV, AJM, AUY, ASZ, AXR, ATD	1.9	1998.10 - 2005.05		4264.87D
2.0	APK, AZH, AZJ, AQY, AZG, BBW	2.0	1998.10 - 2005.05		3141.87D
2.3 V5	AGZ, AQN	2.3	1998.10 - 2000.10	Chassis No. →1J-X-800 000	4264.87D
2.3 V5	AGZ, AQN	2.3	1998.11 - 2000.10	Chassis No. 1J-Y-000 001→ 1J-2-799 999	4123.80D
2.3 V5	AGZ, AQN	2.3	1998.12 - 2005.05	Chassis No. 1J-3-000 001→	4455.80D
2.8 V6	AQP, AUE, BDE	2.8	1999.03 - 2005.05	Chassis No. →1J-2-799 999	4123.80D
2.8 V6	AQP, AUE, BDE	2.8	1999.04 - 2005.05	Chassis No. 1J-3-000 001→	4455.80D
<b>CADDY I</b>					
1.5	JB	1.5	1982.08 - 1983.07		4264.87D
1.6	EM, EW	1.6	1982.10 - 1983.10		4264.87D
1.6 D	JK, ME	1.6	1982.08 - 1992.07		4253.87D
1.8	JH	1.8	1985.08 - 1992.07		4264.87D

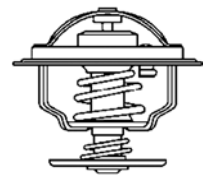

# VOLKSWAGEN

	Engine	Ltr.	Year	Restriction*	Thermostat
<b>CADDY II (9K9)</b>					
1.4	AUA, AEX, AKV, APQ, AUD	1.4	1995.11 - 2004.01	mit Gehäuse	410989.87D
1.4 16V	AUA	1.4	2000.08 - 2004.01	mit Gehäuse	410989.87D
1.6	1F	1.6	1995.11 - 1997.05		4264.87D
1.6	AEE	1.6	1997.06 - 2000.09	mit Gehäuse	410989.87D
1.7 SDI	AHB	1.7	1996.07 - 2000.09		4264.87D
1.9 D	1Y	1.9	1995.11 - 2004.01		4264.87D
1.9 SDI	AYQ, AEY	1.9	1995.11 - 2004.01		4264.87D
1.9 TDI	1Z, AHU, ALH, ALE	1.9	1996.09 - 2004.01		4264.87D
60 1.4	AEX, APQ, AUD	1.4	1995.11 - 2004.01	mit Gehäuse	410989.87D
75 1.6	AEE	1.6	1995.11 - 2000.09	mit Gehäuse	410989.87D
75 1.6	1F	1.6	1995.11 - 1997.05		4264.87D
<b>CADDY II Pick-up (9U7)</b>					
1.6	AEE	1.6	1996.06 - 2000.12	mit Gehäuse	410989.87D
1.9 D	AEF	1.9	1996.06 - 2000.12		4264.87D
<b>CADDY III (2KB, 2KJ)</b>					
1.4	BCA	1.4	2004.03 - 2006.05	mit Gehäuse	410475.87D
1.4 16V	BUD	1.4	2006.05 - 2010.08		3143.87D
1.6	BGU, BSF, BSE	1.6	2004.04 -		3141.87D
1.6 BiFuel	CHGA	1.6	2011.05 -		3141.87D
1.6 TDI	CAYD, CAYE	1.6	2010.08 -		410845.92D
1.9 TDI	BJB	1.9	2004.04 - 2010.08		4264.87D
1.9 TDI	BLS, BSU	1.9	2004.04 - 2010.08		4820.87D
2.0 EcoFuel	BSX	2.0	2006.04 -		3141.87D
2.0 SDI	BST, BDJ	2.0	2004.03 - 2010.08		4264.87D
2.0 TDI	BMM	2.0	2007.09 - 2010.08		4820.87D
2.0 TDI	CLCA, CFHF, CFJA	2.0	2010.08 -		410845.87D
2.0 TDI 16V	CFHC, CLCB	2.0	2010.11 -		410845.87D
<b>CADDY III (2C, 2K, 2KH, 2CA, 2CH)</b>					
1.4	BCA	1.4	2004.03 - 2006.05	mit Gehäuse	410475.87D
1.4 16V	BUD	1.4	2006.05 - 2010.08	mit Gehäuse	410475.87D
1.6	BGU, BSF, BSE	1.6	2004.04 -		3141.87D
1.6 BiFuel	CHGA	1.6	2011.05 -		3141.87D
1.6 TDI	CAYD, CAYE	1.6	2010.08 -		410845.92D
1.9 TDI	BJB	1.9	2004.04 - 2010.08		4264.87D
1.9 TDI	BLS, BSU	1.9	2004.04 - 2010.08		4820.87D
2.0 EcoFuel	BSX	2.0	2006.04 -		3141.87D
2.0 SDI	BST, BDJ	2.0	2004.03 - 2010.08		4264.87D
2.0 TDI	BMM	2.0	2007.09 - 2010.08		4820.87D
2.0 TDI	CLCA, CFHE, CFHF, CFJA	2.0	2010.08 -		410845.87D
2.0 TDI 16V	CFHC, CLCB	2.0	2010.11 -		410845.87D
<b>CC (358)</b>					
2.0 TDI	FFFA, CFFB, CFGB, CFGC, CLLA	2.0	2011.11 -		410845.87D
<b>CORRADO</b>					
1.8 16V	KR	1.8	1989.04 - 1992.07		4264.87D
1.8 G60	PG	1.8	1988.09 - 1993.09		4264.87D
2.0 i	ADY, 2E	2.0	1993.04 - 1995.12		4264.87D
2.0 i 16V	9A	2.0	1991.08 - 1995.12		4264.87D
2.9 VR6	ABV	2.9	1991.08 - 1995.12		4123.80D

# VOLKSWAGEN

Engine

Ltr.

Year

Restriction\*

Thermostat

## CRAFTER

2.5 TDI	BJJ, BJK, BJL, BJM, CEBA, CEBB, CECA, CECB	2.5	2006.04 -		4116.87D1
---------	--	-----	-----------	--	-----------

## DERBY (86, 86C, 80)

0.9	HA	0.9	1977.02 - 1981.09		3091.92D
1.0	HZ	1.0	1981.08 - 1984.12		4264.84D
1.0	GL	1.0	1981.10 - 1984.12		3091.92D
1.1	HB	1.1	1977.02 - 1983.07		3091.92D
1.3	GK, HH, HJ, HK, HW	1.3	1977.02 - 1984.12		3091.92D

## EOS

2.0 FSI	BVZ, BVY	2.0	2006.03 - 2008.05		411186.87D
2.0 TDI	BMM	2.0	2006.06 - 2008.05		4820.87D
2.0 TDI	CFFA	2.0	2010.11 -		410845.87D
2.0 TDI 16V	CBAB	2.0	2008.05 - 2009.07		3472.87D
2.0 TDI 16V	CFFB	2.0	2008.05 -		410845.87D
2.0 TFSI	BPY, BWA	2.0	2006.03 -		411187.87D
3.2 V6	CBRA, BUB	3.2	2006.06 - 2009.05		4455.80D

## FOX (5Z1, 5Z3)

1.4	BKR	1.4	2005.04 -	mit Gehäuse	410475.87D
1.4 TDI	BNM	1.4	2005.04 -		4264.87D
1.9 D	ASY	1.9	2007.12 -		4264.87D
GOL	1.6 Rally	BJF	1.6	2003.08 - 2005.01	4256.80D
1.6 Rally	BJF	1.6	2003.08 - 2005.01		4264.87D
1.8	UDH	1.8	2002.06 - 2008.05		4264.87D

## GOLF I (17)

1.1	FA, FJ, GG, HC	1.1	1974.04 - 1983.07		3091.92D
1.3	GF, GS	1.3	1979.08 - 1983.12		3091.92D
1.5	FH	1.5	1974.04 - 1975.12		4256.80D
1.5	JB	1.5	1977.08 - 1983.07		4264.87D
1.5 D	CK	1.5	1976.08 - 1980.07		4256.80D
1.6	EM, FN, FP, FT	1.6	1975.08 - 1984.02		4256.80D
1.6	EW, HN	1.6	1983.01 - 1984.02		4264.87D
1.6 D	JK, CR	1.6	1980.08 - 1983.07		4264.87D
1.6 GTI	EG	1.6	1976.08 - 1982.07		4256.80D
1.6 TD	CY	1.6	1982.03 - 1983.07		4264.87D
1.8 GTI	JJ, DX	1.8	1982.08 - 1983.12		4264.87D

## GOLF I Cabriolet (155)

1.3	HK	1.3	1983.08 - 1986.07		3091.92D
1.5	JB	1.5	1979.01 - 1983.11		4264.87D
1.6	EG, EW, HN, RE	1.6	1979.08 - 1982.07		4264.87D
1.8	2H, EV, EX, PB, DX, JH	1.8	1982.08 - 1993.04		4264.87D

## GOLF II (19E, 1G1)

1.0	GN	1.0	1983.11 - 1985.08		3091.92D
1.0	HZ	1.0	1985.08 - 1991.10		4264.84D
1.3	GT, HK	1.3	1983.08 - 1987.06		3091.92D
1.3	2G, MH, NU, NZ	1.3	1983.08 - 1992.12		4264.84D
1.6	HM, ABN, EZ, PN, RF	1.6	1983.08 - 1992.12		4264.87D
1.6 D	ME, JP	1.6	1983.08 - 1991.10		4264.87D

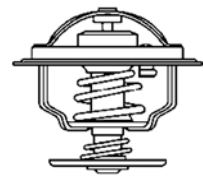

# VOLKSWAGEN

	Engine	Ltr.	Year	Restriction*	Thermostat
1.6 TD	1V, JR, MF, RA, SB	1.6	1983.08 - 1991.10		4264.87D
1.8	1P, GX, GU, HV, RH	1.8	1984.08 - 1991.10		4264.87D
1.8 GTI	EV, GZ, PB, DX, HT, RD, RV, PF	1.8	1983.08 - 1991.10		4264.87D
1.8 GTI 16V	KR, PL	1.8	1986.02 - 1991.10		4264.87D
1.8 GTI G60	PG, 1H	1.8	1988.08 - 1991.12		4264.87D
1.8 i	GX, RP	1.8	1987.08 - 1991.10		4264.87D
2.0		2.0	1985.08 - 1992.07		4264.87D
<b>GOLF III (1H1, 1H5)</b>					
1.3	2G	1.3	1991.08 - 1992.07		4264.87D
1.4	AEX	1.4	1991.10 - 1999.04	mit Gehäuse	410989.87D
1.4	ABD	1.4	1991.10 - 1999.04		4264.84D
1.6	AEE	1.6	1992.09 - 1997.08	mit Gehäuse	410989.87D
1.6	ABU, AEA	1.6	1992.09 - 1997.08		4264.84D
1.6	AEK, AFT, AKS	1.6	1994.07 - 1999.04		4264.87D
1.8	AAM, ABS, ACC, ADZ, ANN, ANP	1.8	1991.11 - 1999.04		4264.87D
1.9 D	1Y	1.9	1991.11 - 1999.04		4253.87D
1.9 GTD	AAZ	1.9	1991.11 - 1997.08		4253.87D
1.9 SDI	AEY	1.9	1995.07 - 1999.04		4253.87D
1.9 TD	AAZ	1.9	1993.07 - 1999.04		4253.87D
1.9 TDI	ALE, 1Z, AHU, AFN	1.9	1993.09 - 1999.04		4253.87D
2.0	ABA, ADY, AKR, 2E, AGG, AEP	2.0	1991.11 - 1999.04		4264.87D
2.0 GTI 16V	ABF	2.0	1992.08 - 1997.08		4264.84D
2.8 VR6	AAA	2.8	1992.01 - 1997.09		4123.80D
2.9 VR6	ABV	2.9	1994.10 - 1999.04		4123.80D
<b>GOLF III Cabriolet (1E7)</b>					
1.6	AEK, AFT, AKS	1.6	1994.10 - 1998.05		4264.87D
1.8	AAM, ADZ, ABS	1.8	1993.07 - 1998.05		4264.87D
1.9 TDI	ALE, 1Z, AHU, AFN	1.9	1995.08 - 1998.05		4253.87D
2.0	ADY, AKR, 2E, AGG	2.0	1993.07 - 1998.05		4264.87D
<b>GOLF IV (1J1, 1J5)</b>					
1.4 16V	AHW, AXP, BCA, APE, AKQ	1.4	1999.05 - 2006.06	mit Gehäuse	410989.87D
1.6	AKL, APF, AEH	1.6	1997.08 - 2004.05		3141.87D
1.6 16V	AUS, ATN, BCB, AZD	1.6	2000.02 - 2006.06	mit Gehäuse	410989.87D
1.8	AGN	1.8	1997.08 - 2005.06		3141.87D
1.8 T	ARZ, AQA, AGU, AUM, AWD	1.8	1997.08 - 2006.06		3141.87D
1.8 T GTI	AUQ	1.8	2001.08 - 2005.06		3141.87D
1.9 SDI	AGP, AQM	1.9	1997.08 - 2006.06		4264.87D
1.9 TD	AAZ	1.9	1997.10 - 1999.09		4253.87D
1.9 TDI	AGR, ALH, AHF, ASV, AJM, AUY, AXR, ATD, ASZ, ARL	1.9	1997.08 - 2006.06		4264.87D
2.0	APK, AZJ, AQY, AZG, AZH	2.0	1998.07 - 2006.06		3141.87D
2.0 Bi-Fuel	BEH	2.0	2002.02 - 2006.06		3141.87D
2.3 V5	AGZ, AQN	2.3	1997.08 - 2006.06	Chassis No. →1J-X-800 000	4264.87D
2.3 V5	AGZ, AQN	2.3	1997.09 - 2006.06	Chassis No. 1J-Y-000 001→ 1J-2-799 999	4123.80D
2.3 V5	AGZ, AQN	2.3	1997.10 - 2006.06	Chassis No. 1J-3-000 001→	4455.80D
2.8 V6	AQP, AUE, BDE	2.8	1999.03 - 2006.06	Chassis No. →1J-2-799 999	4123.80D
2.8 V6	AQP, AUE, BDE	2.8	1999.04 - 2006.06	Chassis No. 1J-3-000 001→	4455.80D
3.2 R32	BFH, BML	3.2	2002.09 - 2005.06		4455.80D

# Thermostats

## VOLKSWAGEN

	Engine	Ltr.	Year	Einschränkung Restriction*	Thermostat
<b>GOLF IV Cabriolet (1E7)</b>					
1.6	AFT, AKS	1.6	1998.06 - 2002.06		4264.87D
1.8	ADZ, ANP, ANN, AAM	1.8	1998.06 - 2002.06		4264.87D
1.9 TDI	ALE, AHU, AVG, AFN	1.9	1998.06 - 2002.06		4264.87D
2.0	ATU, AKR, AWF, AGG, AWG	2.0	1998.06 - 2002.06		4264.87D
<b>GOLF V / PLUS</b>					
1.4	BUD	1.4	2007.06 -	mit Gehäuse	410475.87D
1.4 16V	BCA	1.4	2003.10 - 2006.05	mit Gehäuse	410989.87D
1.4 16V	BUD, CGGA	1.4	2006.05 -	mit Gehäuse	410475.87D
1.6	BGU, BSF, BSE, CCSA, CMXA	1.6	2004.01 -		3141.87D
1.6 BiFuel	CHGA	1.6	2009.05 -		3141.87D
1.6 MultiFuel	CCSA, CMXA	1.6	2007.11 -		3141.87D
1.6 TDI	CAYB, CAYC	1.6	2009.02 - 2010.05	mit Gehäuse	410536.92D
1.6 TDI	CAYB, CAYC	1.6	2009.02 - 2010.05	ohne Gehäuse	410537.92D
1.6 TDI	CAYB, CAYC	1.6	2010.06 -		410845.92D
1.9 TDI	BLS, BXJ	1.9	2003.10 -		4820.87D
1.9 TDI	BKC, BXE, BRU, BXF	1.9	2004.05 -		4264.87D
2.0	BWA, CAWB, CCTA	2.0	2007.06 -		411187.87D
2.0 FSI	BVY, BVZ	2.0	2004.01 - 2008.11		411186.87D
2.0 GTI	BWA, BPY, AXX, CBFA, CAWB, CCTA	2.0	2004.10 - 2009.02		411187.87D
2.0 SDI	BDK	2.0	2004.01 - 2008.11		4264.87D
2.0 TDI	AZV, BMN	2.0	2003.10 -		3472.87D
2.0 TDI	BMM	2.0	2004.08 - 2009.05		4820.87D
2.0 TDI	CBDA, CBDC	2.0	2005.05 - 2009.07		3472.87D
2.0 TDI	CFHB, CLCA	2.0	2005.05 -		410845.87D
2.0 TDI	BEE	2.0	2005.05 - 2007.05		4820.87D
2.0 TDI 16V	CBDB, BKD	2.0	2003.10 -		3472.87D
2.0 TDI 16V	CFHC	2.0	2005.01 - 2009.07		410845.87D
3.2 R32	CBRA, BUB	3.2	2005.11 - 2008.11		4455.80D
<b>GOLF VI</b>					
1.4	BUD, CGGA	1.4	2008.10 -	mit Gehäuse	410475.87D
1.6	CCSA, BSF, CMXA, BSE	1.6	2008.10 - 2012.11		3141.87D
1.6 BiFuel	CHGA	1.6	2009.03 - 2012.11		3141.87D
1.6 MultiFuel	CCSA, CMXA	1.6	2008.10 - 2012.11		3141.87D
1.6 TDI	CAYC, CAYB	1.6	2009.02 - 2010.05	mit Gehäuse	410536.92D
1.6 TDI	CAYC, CAYB	1.6	2009.02 - 2010.05	ohne Gehäuse	410537.92D
1.6 TDI	CAYC, CAYB	1.6	2010.06 - 2012.11		410845.92D
2.0 TDI	CBAA, CBAB, CBBB, CBDC	2.0	2008.10 - 2009.07		3472.87D
2.0 TDI	CFFA, CFFB, CFGB, CFHB, CLCA	2.0	2008.11 - 2013.05		410845.87D
2.0 TDI	BMM	2.0	2009.07 - 2013.05		4820.87D
2.0 TDI 16V	CJAA, CBDB, CFHC, CLCB	2.0	2009.07 -		410845.87D
<b>GOLF VI Cabriolet (517)</b>					
1.6 TDI	CAYC	1.6	2011.03 -		410845.92D
2.0 TDI	CFHC	2.0	2011.11 -		410845.92D
<b>ILTIS</b>					
1.6 TD	1C	1.6	1987.08 - 1988.12		4253.87D
1.7	YX, WL	1.7	1979.03 - 1988.12		4264.87D

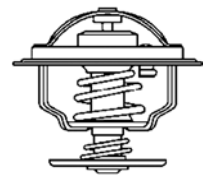

# VOLKSWAGEN

	Engine	Ltr.	Year	Restriction*	Thermostat
<b>JETTA I (16)</b>					
1.1	GG, FA	1.1	1978.08 - 1984.02		3091.92D
1.3	GF, GS	1.3	1979.08 - 1984.02		3091.92D
1.5	JB	1.5	1978.08 - 1984.02		4264.87D
1.5 D	CK	1.5	1978.08 - 1980.07		4264.87D
1.6	EM, EW, FR	1.6	1978.08 - 1983.07		4256.80D
1.6 D	JK, CR	1.6	1980.08 - 1984.02		4264.87D
1.6 GLI	EG	1.6	1978.08 - 1982.07		4264.87D
1.6 TD	CY	1.6	1982.03 - 1984.02		4264.87D
1.8	JJ, DX	1.8	1982.08 - 1984.02		4264.87D
<b>JETTA II (19E, 1G2, 165)</b>					
1.3	GT, HK	1.3	1984.01 - 1987.06		3091.92D
1.3	2G, MH, NZ	1.3	1984.01 - 1991.12		4264.84D
1.6	HM, ABN, EZ, PN, RF	1.6	1984.01 - 1992.07		4264.87D
1.6 D	ME, JP	1.6	1984.01 - 1991.10		4264.87D
1.6 TD	1V, JR, MF, RA, SB	1.6	1984.01 - 1991.10		4264.87D
1.8	1P, EV, GZ, PB, GX, GU, HV, RP, PF, RD, RH	1.8	1984.01 - 1991.10		4264.87D
1.8 16V	KR, PL	1.8	1986.08 - 1991.10		4264.87D
<b>JETTA III (1K2)</b>					
1.6	BGU, CCSA, BSF, BSE	1.6	2005.10 - 2010.10		3141.87D
1.6 MultiFuel	CCSA	1.6	2008.01 - 2010.10		3141.87D
1.6 TDI	CAYC	1.6	2009.06 - 2010.05	mit Gehäuse	410536.92D
1.6 TDI	CAYC	1.6	2009.06 - 2010.05	ohne Gehäuse	410537.92D
1.9 TDI	BKC, BXE	1.9	2005.08 - 2010.10		4264.87D
1.9 TDI	BLS	1.9	2005.08 - 2010.10		4820.87D
2.0 FSI	BVY, BVZ	2.0	2005.08 - 2010.10		411186.87D
2.0 TDI	AZV, CBDA	2.0	2005.09 - 2009.07		3472.87D
2.0 TDI	BMM, BMN	2.0	2005.10 - 2010.10		4820.87D
2.0 TDI 16V	CJAA, CBDB, BKD	2.0	2005.08 - 2010.10		3472.87D
2.0 TFSI	BWA, BPY, AXX, CBFA, CCZA, CAWB, CCTA	2.0	2005.10 - 2010.10		411187.87D
2.5 FSI	BTK, BGP, CCCA, CBUA, CBTA	2.5	2006.01 - 2010.10		4488.80D0
<b>JETTA IV (162)</b>					
1.6 TDI	CAYC	1.6	2011.02 -	mit Gehäuse	410536.92D
1.6 TDI	CAYC	1.6	2011.02 -	ohne Gehäuse	410537.92D
2.0 TDI	CFHC, CFFB, CLCA	2.0	2010.10 -		410845.87D
<b>LT 28 - 55</b>					
2.0	CH	2.0	1975.04 - 1983.09		4006.82D
2.3	AGL	2.3	1996.05 - 2006.07		4275.87D
2.4	DL	2.4	1982.12 - 1992.07		4123.80D
2.4 D	1S, ACT, DW	2.4	1978.12 - 1996.06		4123.80D
2.4 i	1E	2.4	1989.08 - 1996.06		4123.80D
2.4 TD	1G, ACL, DV	2.4	1978.08 - 1996.06		4123.80D
2.5 SDI	AGX	2.5	1996.07 - 2006.07		4116.87D1
2.5 TDI	AHD, AVR, ANJ, APA, BBE, BBF	2.5	1996.05 - 2006.07		4116.87D1
2.7 D	CG	2.7	1975.11 - 1980.01		4006.82D
2.8 TDI	AGK, ATA, BCQ, AUH	2.8	1997.06 - 2006.07		3145.79D



## VOLKSWAGEN

	Engine	Ltr.	Year	Restriction*	Thermostat
<b>LUPO</b>					
1.0	AER, ALD, ANV, ALL, AUC	1.0	1998.09 - 2005.07	mit Gehäuse	<b>410989.87D</b>
1.2 TDI 3L	AYZ, ANY	1.2	1999.07 - 2005.07		<b>4264.87D</b>
1.4	AUD	1.4	2000.10 - 2005.07	mit Gehäuse	<b>410989.87D</b>
1.4 16V	AHW, APE, BBY, AKQ, AUA, AFK, AUB, AQQ	1.4	1999.08 - 2005.07	mit Gehäuse	<b>410989.87D</b>
1.4 TDI	AMF	1.4	1999.01 - 2005.07		<b>4264.87D</b>
1.6 GTI	AVY	1.6	2000.09 - 2005.07	mit Gehäuse	<b>410475.80D</b>
1.7 SDI	AKU	1.7	1998.09 - 2005.07		<b>4264.87D</b>
<b>MULTIVAN T5</b>					
1.9 TDI	AXC, AXB, BRS	1.9	2003.04 - 2009.11		<b>4264.87D</b>
1.9 TDI	BRR	1.9	2006.01 - 2009.11		<b>3472.87D</b>
2.0	AXA	2.0	2003.11 -		<b>3141.87D</b>
2.5 TDI	AXE, BPC, AXD, BNZ, BLJ	2.5	2003.04 - 2009.11		<b>4430.87D</b>
3.2	BDL	3.2	2003.11 - 2006.06		<b>4455.80D</b>
3.2 V6	BDL, BKK	3.2	2004.02 - 2009.11		<b>4455.80D</b>
<b>PARATI</b>					
1.0	ASW, AZP	1.0	2002.08 -		<b>4264.87D</b>
1.6	BJF, UNF, UPD	1.6	2003.07 -	80° Variante	<b>4256.80D</b>
1.6	BJF, UNF, UPD	1.6	2003.07 -	87° Variante	<b>4264.87D</b>
1.8	UDH	1.8	2002.08 -	80° Variante	<b>4256.80D</b>
1.8	UDH	1.8	2002.08 -	87° Variante	<b>4264.87D</b>
1.9 D	1Y	1.9	2002.08 -		<b>4264.87D</b>
1.9 SDI	BGG	1.9	2002.08 -		<b>4264.87D</b>
2.0	UQG	2.0	2003.07 -		<b>4264.87D</b>
<b>PASSAT (32/33)</b>					
1.3	FY	1.3	1973.05 - 1980.07		<b>3091.92D</b>
1.3	ZF	1.3	1973.05 - 1978.01		<b>4256.80D</b>
1.3	ZA	1.3	1973.05 - 1978.01		<b>4264.87D</b>
1.5	ZB, YJ, ZC	1.5	1973.05 - 1975.12		<b>4256.80D</b>
1.5 D	CK	1.5	1977.02 - 1980.07		<b>4256.80D</b>
1.6	FS, YN, YP	1.6	1975.08 - 1980.07	Chassis No. →328 2300 000	<b>4256.80D</b>
1.6	FS, YN, YP	1.6	1975.09 - 1980.07	Chassis No. 328 2000 001→	<b>4264.87D</b>
1.6 D	CR	1.6	1979.02 - 1980.07		<b>4264.87D</b>
1.6 i	YS	1.6	1978.06 - 1980.07		<b>4264.87D</b>
<b>PASSAT (32B)</b>					
1.3	FY, FZ	1.3	1980.08 - 1986.07		<b>3091.92D</b>
1.3	EP, EU	1.3	1980.08 - 1986.07		<b>4264.87D</b>
1.6	DT, RL, YP, WV, YN	1.6	1980.08 - 1988.03		<b>4264.87D</b>
1.6 D	JK, CR	1.6	1980.08 - 1988.03		<b>4253.87D</b>
1.6 TD	CY, RA	1.6	1982.04 - 1988.03		<b>4253.87D</b>
1.8	DS, JN, JV, DZ, RM	1.8	1983.01 - 1988.03		<b>4264.87D</b>
1.9	WN	1.9	1981.01 - 1983.07		<b>4116.87D1</b>
2.0	JS, HP	2.0	1983.08 - 1988.03		<b>4116.87D1</b>
2.1	WE	2.1	1981.01 - 1983.07		<b>4116.87D1</b>
2.2	JT, KV, KX	2.2	1985.01 - 1988.03		<b>4116.87D1</b>

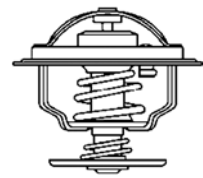

# VOLKSWAGEN

	Engine	Ltr.	Year	Restriction*	Thermostat
<b>PASSAT (35I, 3A2, 3A5)</b>					
1.6	1F, ABN, EZ, AEK, AFT	1.6	1988.02 - 1996.08		4264.87D
1.6 TD	RA, SB	1.6	1988.08 - 1993.09		4253.87D
1.8	AAM, RP, ADZ, ABS, PF, PB, KR	1.8	1988.02 - 1997.05		4264.87D
1.8 16V	KR	1.8	1988.04 - 1989.12		4264.87D
1.8 G60	PG	1.8	1988.08 - 1997.05		4264.87D
1.9 D	1Y	1.9	1989.05 - 1993.10		4253.87D
1.9 TD	AAZ	1.9	1991.03 - 1997.05		4253.87D
1.9 TDI	1Z, AFN, AHU	1.9	1993.10 - 1997.05		4253.87D
2.0	ABA, ADY, 2E, AGG, AEP	2.0	1988.04 - 1997.05		4264.87D
2.0 16V	9A	2.0	1988.08 - 1993.09		4264.87D
2.0 16V	ABF	2.0	1994.01 - 1997.05		4264.84D
2.8 VR6	AAA	2.8	1991.06 - 1997.05		4123.80D
2.9 VR6	ABV	2.9	1994.01 - 1997.05		4123.80D
<b>PASSAT (3B2, 3B5)</b>					
1.6	AHL, ADP, ARM, ANA	1.6	1996.10 - 2000.11		3141.87D
1.8	ADR, APT, ARG, AFY	1.8	1996.10 - 2000.11		3141.87D
1.8 T	AEB, ANB, APU	1.8	1996.10 - 2000.11		3141.87D
1.9 TDI	AHU, AHH, ATJ, AJM, AVB, AVG, AFN	1.9	1996.10 - 2000.11		4264.87D
2.3 VR5	AGZ	2.3	1996.10 - 2000.11		4264.87D
2.5 TDI	AKN, AFB	2.5	1998.07 - 2000.11		4274.87D
2.8	AGE	2.8	1997.05 - 1999.09	Chassis No. →3B-X-500 000	4274.87D
2.8	AGE	2.8	1997.06 - 1999.09	Chassis No. 3B-X-500 001→	4274.92D
2.8 V6	ACK, ALG, APR, AQD	2.8	1996.08 - 2000.11		4274.87D
2.8 V6	AGE	2.8	1997.05 - 1999.09	Chassis No. →3B-X-500 000	4274.87D
2.8 V6	AGE	2.8	1997.06 - 1999.09	Chassis No. 3B-X-500 001→	4274.92D
2.8 V6	ATX, BBG	2.8	1999.09 - 2000.11		4274.92D
<b>PASSAT (3B3, 3B6)</b>					
1.6	ALZ	1.6	2000.11 - 2005.05		3141.87D
1.8 T	AWM	1.8	2001.02 - 2005.08		3141.87D
1.8 T 20V	AWT	1.8	2000.11 - 2005.05		3141.87D
1.9 TDI	AVB, AWX, AVF	1.9	2000.11 - 2005.05		4264.87D
2.0	AZM	2.0	2000.11 - 2005.05		3141.87D
2.0 TDI	BGW, BHW	2.0	2003.12 - 2005.05		4264.87D
2.3 V5	AZX	2.3	2000.11 - 2005.05		4123.80D
2.3 VR5	AZX	2.3	2000.11 - 2005.05		4123.80D
2.5 TDI	AKN, AFB, BAU, BDH, BDG	2.5	2000.11 - 2005.05		4274.87D
2.8	ATQ, AMX	2.8	2000.11 - 2005.05		4274.92D
<b>PASSAT (3C2, 3C5)</b>					
1.6	BSF, BSE	1.6	2005.05 - 2010.11		3141.87D
1.6 TDI	CAYC	1.6	2009.08 - 2010.11	mit Gehäuse	410536.92D
1.6 TDI	CAYC	1.6	2009.08 - 2010.11	ohne Gehäuse	410537.92D
1.9 TDI	BXE, BKC	1.9	2005.03 - 2008.11		4264.87D
1.9 TDI	BLS	1.9	2005.03 - 2008.11		4820.87D
2.0 BlueTDI	CBAC	2.0	2009.01 - 2009.07		3472.87D
2.0 FSI	BVY, BVZ	2.0	2005.03 - 2010.11		411186.87D
2.0 FSI	AXX, BPY, BWA	2.0	2005.07 - 2010.11		411187.87D
2.0 FSI	BLX, BVX	2.0	2005.09 - 2010.11	Chassis No. 3C-6-160 001→	411186.87D

# Thermostats

## VOLKSWAGEN

	Engine	Ltr.	Year	Restriction*	Thermostat
2.0 TDI	BMA, BUZ, BVE, BWV, CBBB, BMR	2.0	2005.03 - 2010.11		3472.87D
2.0 TDI	CBAA, CBDC	2.0	2005.03 - 2009.07		3472.87D
2.0 TDI	BMP	2.0	2005.03 -		4820.87D
2.0 TDI 16V	CBAB	2.0	2005.03 - 2009.07		3472.87D
2.0 TDI 16V	BKP	2.0	2005.03 -		3472.87D
<b>PASSAT (362, 365)</b>					
1.6 TDI	CAYC	1.6	2010.08 - 2010.11	mit Gehäuse	410536.92D
1.6 TDI	CAYC	1.6	2010.08 - 2010.11	ohne Gehäuse	410537.92D
1.6 TDI	CAYC	1.6	2010.12 -		410845.92D
2.0 TDI	CFFA, CFFB, CFGB, CFGC, CLLA	2.0	2010.08 -		410845.87D
<b>PASSAT CC</b>					
2.0 BlueTDI	CBAC	2.0	2009.05 - 2010.11		3472.87D
2.0 TDI	CBAA, CBAB, CBBB	2.0	2008.06 - 2009.07		3472.87D
2.0 TDI	CFFA, CFFB, CFGB	2.0	2008.06 -		410845.87D
<b>PHAETON</b>					
3.2 V6	AYT, BKL, BRK	3.2	2002.04 -		4455.80D
5.0 V10 TDI	AJS	5.0	2002.11 -		4572.105D
<b>POLO (80, 86, 86C) 1975→1994</b>					
0.8	HE	0.8	1975.09 - 1981.09		3091.92D
0.9	HA	0.9	1975.09 - 1981.12		3091.92D
1.0	GL	1.0	1981.10 - 1986.10		3091.92D
1.0	AAU, AAK, ACM, HZ	1.0	1981.10 - 1994.09		4264.84D
1.1	HB, HC	1.1	1975.03 - 1989.09		3091.92D
1.3	GT, GK, HJ, HK, HH, HW	1.3	1976.12 - 1988.07		3091.92D
1.3	2G, 3F, AAV, NZ, MH	1.3	1983.08 - 1994.09		4264.84D
1.3 D	MN	1.3	1986.08 - 1990.08		4264.84D
1.3 G40	PY	1.3	1987.01 - 1994.09		4264.84D
1.4 D	1W	1.4	1990.08 - 1994.09		4264.84D
<b>POLO (6N_) 1994→1999</b>					
1.0	AAU	1.0	1994.10 - 1999.12		4264.84D
1.4	AEX, APQ	1.4	1998.05 - 1999.12	mit Gehäuse	410989.87D
1.6	AEA	1.6	1994.09 - 1995.12		4264.87D
1.7 SDI	AHG, AKU	1.7	1997.04 - 1999.12		4264.87D
1.9 D	AEF	1.9	1994.10 - 1999.12		4264.87D
1.9 SDI	AGD	1.9	1996.07 - 1999.12		4264.87D
100 1.4 16V	AFH	1.4	1996.04 - 1999.10	mit Gehäuse	410989.87D
120 1.6 16V GTI	AJV	1.6	1998.09 - 1999.10	mit Gehäuse	410989.80D
45 1.0	AEV	1.0	1994.10 - 1996.09		4253.87D
50 1.0	AER, ALL	1.0	1996.09 - 1999.10	mit Gehäuse	410989.87D
55 1.3	ADX	1.3	1994.10 - 1995.07		4253.87D
55 1.4	AEX	1.4	1995.08 - 1999.10	mit Gehäuse	410989.87D
60 1.4	AEX, AKV, APQ	1.4	1995.07 - 1999.10	mit Gehäuse	410989.87D
60 1.7 SDI	AKU	1.7	1997.08 - 1999.10		4264.87D
64 1.9 D	AEF	1.9	1994.10 - 1999.10		4264.87D
64 1.9 SDI	AGD	1.9	1996.07 - 1999.10		4264.87D
75 1.6	AEE, AHS	1.6	1994.10 - 1999.10	mit Gehäuse	410989.87D
75 1.6	AEA	1.6	1994.10 - 1999.10		4264.87D

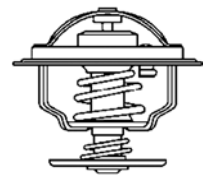

# VOLKSWAGEN

	Engine	Ltr.	Year	Restriction*	Thermostat
<b>POLO (6KV2, 6KV5, 6N2) 1999→2002</b>					
1.0	ALD, AUC	1.0	1999.10 - 2001.09	mit Gehäuse	410989.87D
1.4	AEX, AKV, ANW, AKK, APQ, AUD, ANX, AKP	1.4	1997.05 - 2001.09	mit Gehäuse	410989.87D
1.4 16V	AFK, AUB, AQQ, AHW, APE, AUA	1.4	1999.10 - 2001.09	mit Gehäuse	410989.87D
1.4 TDI	AMF	1.4	1999.10 - 2001.09		4264.87D
1.6	AEH, AKL, APF, AUR	1.6	1997.05 - 2001.09		3141.87D
1.6	ALM, AEE	1.6	1997.05 - 2001.09	mit Gehäuse	410989.87D
1.6	AFT	1.6	1997.05 - 2001.09		4264.87D
1.6 16V GTI	AVY, ARC	1.6	1999.10 - 2001.09	mit Gehäuse	410989.80D
1.7 SDI	AKU, AKW	1.7	1997.08 - 2001.09		4264.87D
1.8	ADZ	1.8	1997.05 - 2001.09		4264.87D
1.9 D	AEF	1.9	1999.10 - 2001.09		4264.87D
1.9 SDI	AEY, AGP, AQM, ASX, AGD	1.9	1996.06 - 2001.09		4264.87D
1.9 TDI	ALE, AHU, AGR, ALH, AFN, ASV	1.9	1997.05 - 2001.09		4264.87D
100 1.6	AEH, AKL, APF, AUR	1.6	1995.12 - 2001.09		3141.87D
100 1.6	AFT	1.6	1995.12 - 2001.09		4264.87D
110 1.9 TDI	AFN, ASV	1.9	1998.06 - 2002.01		4264.87D
2.0	ADC	2.0	1999.08 - 2001.09		4264.87D
54 1.4	ANX	1.4	1998.01 - 1999.08	mit Gehäuse	410989.87D
57 1.7 SDI	AKW	1.7	1997.07 - 2001.09		4264.87D
60 1.4	AEX, AKV, ANW, AKK, APQ, AUD	1.4	1995.12 - 2001.09	mit Gehäuse	410989.87D
64 1.9 D	1Y	1.9	1996.01 - 1996.10		4264.87D
64 1.9 SDI	AEY	1.9	1995.12 - 1999.08		4264.87D
68 1.9 SDI	AGP, AQM	1.9	1999.08 - 2002.01		4264.87D
75 1.4 16V	APE, AUA	1.4	1999.10 - 2001.09	mit Gehäuse	410989.87D
75 1.6	AEE, ALM	1.6	1995.11 - 2001.09	mit Gehäuse	410989.87D
75 1.6	1F	1.6	1995.11 - 1997.09		4264.87D
90 1.8	ADZ, ADD, ABS	1.8	1997.01 - 2001.09		4264.87D
90 1.9 TDI	ALE, AHU, AGR, ALH	1.9	1996.09 - 2001.09		4264.87D
<b>POLO (9_) 2001→2010</b>				mit Gehäuse	
1.4	BBY, BKY, BBZ	1.4	2003.07 -		410475.87D
1.4 16V	BBY, BKY, BBZ, BUD	1.4	2001.10 - 2009.11	mit Gehäuse	410475.87D
1.4 16V	AUA, AUB	1.4	2001.10 - 2008.05	mit Gehäuse	410989.87D
1.4 TDI	AMF, BAY, BMS, BNV, BNM, BWB	1.4	2001.10 - 2009.11		4264.87D
1.8 GTI	BJX	1.8	2005.09 - 2009.11		3141.87D
1.8 GTi Cup Edition	BBU	1.8	2006.05 - 2009.11		3141.87D
1.9 SDI	ASY	1.9	2001.10 - 2009.11		4264.87D
1.9 TDI	ATD, AXR, ASZ, BLT	1.9	2001.10 - 2009.11		4264.87D
1.9 TDI	BMT	1.9	2001.10 - 2009.11		4820.87D
<b>POLO (6R_) 2009→</b>					
1.4	CGGB	1.4	2009.06 -	mit Gehäuse	410475.87D
1.6 TDI	CAYA, CAYB, CAYC, CLNA	1.6	2009.06 - 2010.05	mit Gehäuse	410536.92D
1.6 TDI	CAYA, CAYB, CAYC, CLNA	1.6	2009.06 - 2010.05	ohne Gehäuse	410537.92D
1.6 TDI	CAYA, CAYB, CAYC, CLNA	1.6	2010.06 -		410845.92D
<b>SANTANA (32B)</b>					
1.3	FZ	1.3	1981.08 - 1983.07		3091.92D
1.3	EP	1.3	1984.08 - 1985.12		4264.87D
1.6	DT, WV, YP	1.6	1981.08 - 1984.12		4264.87D
1.6 D	JK, CR	1.6	1981.08 - 1984.12		4253.87D
1.6 TD	CY	1.6	1981.12 - 1984.12		4253.87D

# Thermostats

## VOLKSWAGEN

	Engine	Ltr.	Year	Restriction*	Thermostat
1.8	DS	1.8	1983.01 - 1984.12		4264.87D
1.9	WN	1.9	1981.08 - 1983.07		4116.87D1
2.0	JS, HP	2.0	1983.08 - 1984.12		4116.87D1
2.1	WE	2.1	1982.08 - 1983.12		4116.87D1

## SAVEIRO

1.6	BJF	1.6	2002.03 -	80° Variante	4256.80D
1.6	BJF	1.6	2002.03 -	87° Variante	4264.87D
1.6 Flex	BJY	1.6	2002.03 -	80° Variante	4256.80D
1.6 Flex	BJY	1.6	2002.03 -	87° Variante	4264.87D
1.8	UDH	1.8	2002.03 -	80° Variante	4256.80D
1.8	UDH	1.8	2002.03 -	87° Variante	4264.87D
2.0	UQG	2.0	2002.03 -		4264.87D

## SCIROCCO (53, 53B)

1.1	FA	1.1	1974.04 - 1979.07		3091.92D
1.3	GF	1.3	1979.08 - 1983.12		3091.92D
1.5	FD, FH	1.5	1974.02 - 1977.12		4256.80D
1.5	JB, ZB, YJ	1.5	1974.02 - 1983.12		4264.87D
1.6	FN, FP, FT	1.6	1975.08 - 1979.07		4256.80D
1.6	EG, EW, EWA, FR, RE	1.6	1975.08 - 1990.07		4264.87D
1.8	EV, EX, JJ, JH, PB, DX	1.8	1985.11 - 1992.07		4264.87D
1.8 16V	KR, PL	1.8	1985.10 - 1992.07		4264.87D

## SCIROCCO (137)

2.0 TDI	CFHB, CFGB, CFHC	2.0	2008.08 -		410845.87D
2.0 TDI	CBBB	2.0	2009.05 - 2009.07		3472.87D

## SHARAN

1.8 T 20V	AWC, AJH	1.8	1997.09 - 2010.03		3141.87D
1.9 TDI	ANU, 1Z, AHU, AVG, AFN, ASZ, BTB, BVK, AUJ	1.9	1995.09 - 2010.03		4264.87D
2.0	ATM, ADY	2.0	1995.09 - 2010.03		4264.87D
2.0 LPG	ATM	2.0	2006.04 - 2010.03		3141.87D
2.0 TDI	BVH	2.0	2005.11 - 2010.03		3472.87D
2.0 TDI	BRT	2.0	2005.11 - 2010.03		4264.87D
2.8 V6 24V	AYL	2.8	2000.04 - 2010.03	Chassis No. →7M-3-010-000	4123.80D
2.8 V6 24V	AYL	2.8	2000.05 - 2010.03	Chassis No. 7M-3-010-001→	4455.80D
2.8 VR6	AAA, AMY	2.8	1995.09 - 2000.04		4123.80D

## SHARAN (7N)

2.0 TDI	CFFA, CFFB, CFFE, CFGB	2.0	2010.05 -		410845.87D
---------	------------------------	-----	-----------	--	------------

## TARO

1.8	2Y	1.8	1989.04 - 1994.09		4103.82D
2.2	4Y	2.2	1989.06 - 1994.07		4103.82D
2.4 D	2L	2.4	1991.09 - 1995.04	Chassis No. →7A-S9501 924, →7A-SH001 995	3477.88D

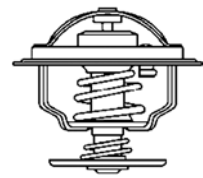

# VOLKSWAGEN

	Engine	Ltr.	Year	Restriction*	Thermostat
<b>TIGUAN (5N_)</b>					
2.0 TDI	CBAA, CBBA, CBAB, CBBB	2.0	2007.11 - 2009.07		3472.87D
2.0 TDI	CFFA, CFFB, CFFD, CLJA, CFGB	2.0	2010.05 -		410845.87D
<b>TOUAREG</b>					
2.5 R5 TDI	BPE, BAC, BLK, BPD	2.5	2003.01 - 2010.05		4430.87D
3.2 V6	AZZ, BMV, BKJ, BAA, BMX, BRJ	3.2	2002.10 - 2006.11		4455.80D
4.2 V8	AXQ	4.2	2002.12 - 2006.11		4274.82D
5.0 R50 TDI	CBWA	5.0	2007.08 - 2010.05		4572.105D
5.0 V10 TDI	AYH, BLE	5.0	2002.10 - 2010.05		4572.105D
<b>TOURAN (1T1, 1T2)</b>					
1.6	BGU, BSF, BSE	1.6	2003.07 - 2010.05		3141.87D
1.9 TDI	AVQ, BKC, BXE, BRU, BXF	1.9	2003.02 - 2004.05		4264.87D
1.9 TDI	BLS, BXJ	1.9	2003.08 - 2010.05		4820.87D
2.0 EcoFuel	BSX	2.0	2006.02 - 2009.05		3141.87D
2.0 TDI	AZV, BMN	2.0	2003.02 - 2010.05		3472.87D
2.0 TDI	CFJA	2.0	2005.12 - 2010.05		410845.87D
2.0 TDI	BMM	2.0	2005.12 - 2010.05		4820.87D
2.0 TDI 16V	BKD	2.0	2003.08 - 2010.05		3472.87D
<b>TOURAN (1T3)</b>					
1.6 TDI	CAYB	1.6	2010.05 -		410845.92D
2.0 TDI	CFHC, CFJA, CFJB, CLCA, CFHF	2.0	2010.05 -		410845.87D
<b>TRANSPORTER T3</b>					
1.6 D	CS	1.6	1981.01 - 1987.07		4253.87D
1.6 TD	JX	1.6	1984.08 - 1992.07	88° Variante	4253.87D
1.6 TD	JX	1.6	1984.10 - 1992.07	80° Variante	4256.80D
1.7 D	KY	1.7	1985.08 - 1992.07	88° Variante	4253.87D
1.7 D	KY	1.7	1985.08 - 1992.07	80° Variante	4256.80D
1.9	DF, DG, DH, GW	1.9	1982.08 - 1992.07		4155.87D
2.1	DJ, MV, SR	2.1	1985.08 - 1992.07		4155.87D
2.1 i	SS	2.1	1989.07 - 1992.07		4155.87D
<b>TRANSPORTER T4</b>					
1.8	PD	1.8	1990.12 - 1992.07		4253.87D
1.9 D	1X	1.9	1990.07 - 1995.12		4264.87D
1.9 TD	ABL	1.9	1992.10 - 2003.04		4264.87D
2.0	AAC	2.0	1990.07 - 2003.04		4264.87D
2.4 D	AAB, AJA	2.4	1990.07 - 2003.04	87° Variante	4116.87D1
2.4 D	AAB, AJA	2.4	1990.07 - 2003.04	80° Variante	4123.80D
2.5	AEN, AAF, ACU, AEU, AVT, AET, APL	2.5	1990.11 - 2003.04		4116.87D1
2.5 TDI	AYC, AUF, ACV, AXL, AXG, AHY, AJT, AYY	2.5	1995.09 - 2003.04		4116.87D1
2.8	AES	2.8	1996.05 - 2000.05		4123.80D
2.8 VR 6	AES	2.8	1995.11 - 2000.04		4123.80D
2.8 VR 6	AMV	2.8	2000.04 - 2003.04	Chassis No. →70-2-275-000	4123.80D
2.8 VR 6	AMV	2.8	2000.05 - 2003.04	Chassis No. 70-2-275-001→	4455.80D

**VOLKSWAGEN**

Engine

Ltr.

Year

Restriction\*

Thermostat

**TRANSPORTER T5**

1.9 TDI	AXB, AXC, BRR, BRS	1.9	2003.04 - 2009.11		<b>4264.87D</b>
2.0	AXA	2.0	2003.11 -		<b>3141.87D</b>
2.5 TDI	AXD, BNZ, AXE, BPC, BLJ	2.5	2003.04 - 2009.11		<b>4430.87D</b>
3.2 4motion	BDL, BKK	3.2	2003.11 - 2009.11		<b>4455.80D</b>
3.2 V6	BDL, BKK	3.2	2003.04 - 2009.11		<b>4455.80D</b>

**VENTO**

1.4	AEX	1.4	1991.11 - 1998.09	mit Gehäuse	<b>410989.87D</b>
1.4	ABD	1.4	1991.11 - 1998.09		<b>4264.84D</b>
1.6	AEE	1.6	1992.09 - 1998.09	mit Gehäuse	<b>410989.87D</b>
1.6	ABU	1.6	1992.09 - 1998.09		<b>4264.84D</b>
1.6	AEA, AEK, AFT	1.6	1992.09 - 1998.09		<b>4264.87D</b>
1.8	AAM, ADZ, ABS	1.8	1991.11 - 1998.09		<b>4264.87D</b>
1.9 D	1Y	1.9	1991.11 - 1998.09		<b>4253.87D</b>
1.9 SDI	AEY	1.9	1997.04 - 1998.09		<b>4253.87D</b>
1.9 TD	AAZ	1.9	1991.11 - 1998.09		<b>4253.87D</b>
1.9 TDI	AFN, ALE, 1Z, AHU	1.9	1993.09 - 1998.09		<b>4253.87D</b>
2.0	ADY, AKR, 2E, AGG, AEP	2.0	1991.11 - 1998.09		<b>4264.87D</b>
2.8 VR6	AAA	2.8	1992.01 - 1998.09		<b>4123.80D</b>

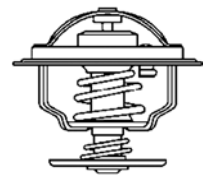

# VOLVO

	Engine	Ltr.	Year	Restriction*	Thermostat
<b>240</b>					
2.0	B 19, B 20	2.0	1974.08 - 1984.12		4089.87D
2.1	B 21	2.1	1974.08 - 1984.07		4089.87D
2.1 Turbo	B 21 ET	2.1	1980.08 - 1985.07		4089.87D
2.3	B 23	2.3	1978.08 - 1989.12		4089.87D
2.3 i	B 230 F	2.3	1986.08 - 1993.07		4089.87D
2.4 Diesel	D 24	2.4	1978.08 - 1993.08		4116.87D1
2.7 GLT6	B 27 E	2.7	1979.08 - 1980.07		4122.87D
<b>260</b>					
2.7	B 27	2.7	1974.08 - 1982.07		4122.87D
2.8	B 28	2.8	1980.08 - 1982.07		4122.87D
<b>340 / 360</b>					
1.4	B 14	1.4	1975.08 - 1988.12		3029.89
1.6 Diesel	D 16	1.6	1984.08 - 1991.07		3470.89D50
1.7	B 17	1.7	1985.08 - 1991.07		3136.88D50
2.0	B 19, B 20	2.0	1980.08 - 1990.07		4089.87D
2.1	B 21 E	2.1	1981.08 - 1982.07		4089.87D
<b>440 / 460 / 480</b>					
1.6	B 16 F	1.6	1988.09 - 1996.12		3470.89D50
1.7	B 18	1.7	1986.04 - 1996.12		3470.89D50
1.7 Turbo	B 18 FT	1.7	1987.08 - 1996.12		3470.89D50
1.8	B 18	1.8	1991.08 - 1996.12		3470.89D50
1.9 Turbo-Diesel	D 19 T	1.9	1994.07 - 1996.12	Fahrgestellnummer →617193	4147.80D
1.9 Turbo-Diesel	D 19 T	1.9	1994.08 - 1996.12	Fahrgestellnummer 617194→	3470.89D50
2.0	B 20 F	2.0	1992.08 - 1996.07		3470.89D50
<b>740</b>					
2.0	B 19	2.0	1983.04 - 1984.07		4089.87D
2.0	B 20	2.0	1985.01 - 1992.07		4089.87D
2.0 16V	B 204 E	2.0	1987.09 - 1990.08		4088.87D
2.0 Turbo	B 200 ET, B 200 FT	2.0	1985.05 - 1991.08		4089.87D
2.3	B 23	2.3	1983.08 - 1992.07		4089.87D
2.3 Turbo	B 23	2.3	1985.08 - 1991.08		4089.87D
2.4 Diesel	D 24	2.4	1984.08 - 1992.07		4116.87D1
2.4 TD	D 24 T, D 24 TIC	2.4	1984.08 - 1990.07		4116.87D1
2.4 TD Interc.	D 24 TIC	2.4	1986.08 - 1988.07		4116.87D1
2.4 Turbo-Diesel	D 24 T	2.4	1985.09 - 1992.07		4116.87D1
<b>760</b>					
2.3	B 230 FT	2.3	1988.01 - 1992.07		4089.87D
2.3 Turbo	B 23 ET	2.3	1982.08 - 1990.08		4089.87D
2.4 D	D 24	2.4	1982.01 - 1992.07		4088.87D
2.4 TD Interc.	D 24 TIC	2.4	1987.08 - 1992.07		4116.87D1
2.4 Turbo Diesel	D 24 T	2.4	1982.08 - 1992.07		4116.87D1
2.8	B 28	2.8	1981.08 - 1991.08		4122.87D
<b>780</b>					
2.9	B 280 E, B 280 F	2.9	1986.08 - 1990.07		4122.87D



# Thermostats

## VOLVO

	Engine	Ltr.	Year	Restriction*	Thermostat
<b>850</b>					
2.0	B 5202 S, B 5204 F	2.0	1991.06 - 1996.12		4272.90D
2.0 Turbo	B 5204 T, B 5204 T2, 5204 FT	2.0	1993.02 - 1997.10		4272.90D
2.3	B 5234 FS	2.3	1996.01 - 1996.10		4272.90D
2.3 T5	B 5234 FT	2.3	1993.02 - 1996.12		4272.90D
2.3 T5 R	B 5234 T4	2.3	1995.08 - 1996.12		4272.90D
2.3 T5 R	B 5234 T2	2.3	1996.04 - 1996.10		4272.90D
2.3 Turbo R	B 5234 T5	2.3	1995.06 - 1997.10		4272.90D
2.4	B 5254 T	2.4	1993.09 - 1997.10		4272.90D
2.5	B 5252, B 5254	2.5	1991.06 - 1996.12		4272.90D
2.5 TDI	D 5252 T	2.5	1995.08 - 1996.12		4116.87D1
<b>940</b>					
2.0	B 20	2.0	1990.09 - 1997.05		4089.87D
2.0 Turbo	B 200 FT	2.0	1990.08 - 1998.10		4089.87D
2.3	B 23	2.3	1990.08 - 1998.10		4089.87D
2.3 ti	B 230 FK	2.3	1995.01 - 1998.10		4089.87D
2.3 Turbo	B 230 FT	2.3	1990.08 - 1998.10		4089.87D
2.4 D	D 24	2.4	1990.08 - 1995.07		4088.87D
2.4 TD Interc.	D 24 TIC	2.4	1994.08 - 1998.10		4088.87D
2.4 TD Intercooler	D 24 TIC	2.4	1990.08 - 1994.12		4088.87D
2.4 Turbo Diesel	D 24 T	2.4	1990.08 - 1994.12		4088.87D
<b>960</b>					
2.0	B 20	2.0	1990.09 - 1993.08		4088.87D
2.3 Turbo	B 230 FT	2.3	1990.09 - 1993.08		4089.87D
2.4 TD Interc.	D 24 TIC	2.4	1991.09 - 1994.07		4116.87D1
2.5	B 6254 S	2.5	1994.07 - 1996.12		4272.90D
2.8	B 28	2.8	1990.09 - 1992.05		4122.87D
2.9	B 6304 F, B 6304 S	2.9	1990.08 - 1994.07		4272.90D
<b>C 30</b>					
1.6	B 4164 S3	1.6	2006.10 - 2012.12		4483.82D
2.4 i	B 5244 S4	2.4	2006.10 - 2012.12		4489.90D
D3	D 5204 T5	2.0	2010.10 - 2012.12		410765.90D ▲
D4	D 5204 T	2.0	2010.10 - 2012.12		410765.90D ▲
D5	D 5244 T8, D 5244 T9, D 5244 T13	2.4	2006.10 - 2012.12	Schaltgetriebe	4816.90D
D5	D 5244 T8, D 5244 T9, D 5244 T13	2.4	2006.10 - 2012.12	Automatikgetriebe	4818.90D
T5	B 5254 T3, B 5254 T7	2.5	2006.10 - 2012.12		4489.90D
<b>C 70 I</b>					
2.0	B 5204 T2	2.0	1997.03 - 2005.10		4272.90D
2.0 T	B 5204 T3, B 5204 T4	2.0	1997.03 - 2005.10		4272.90D
2.3 T-5	B 5234 T3, B 5234 T9	2.3	1997.03 - 2005.10		4272.90D
2.4 T	B 5244 T7	2.4	2002.07 - 2005.10		4272.90D
2.5	B 5244 S, B 5254 S	2.5	1998.06 - 2005.10		4272.90D
2.5 T	B 5254 T, B 5244 T	2.5	1997.03 - 2005.10		4272.90D
<b>C 70 II</b>					
2.4	B 5244 S5	2.4	2006.03 -		4489.90D
2.4 D	D 5244 T9	2.4	2007.03 -	Schaltgetriebe	4816.90D
2.4 D	D 5244 T9	2.4	2007.03 -	Automatikgetriebe	4818.90D
2.4 i	B 5244 S4	2.4	2006.03 -		4489.90D
D3	D 5204 T5	2.0	2010.10 -		410765.90D ▲

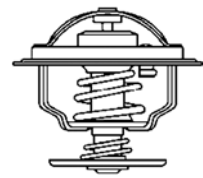

# VOLVO

	Engine	Ltr.	Year	Restriction*	Thermostat
D4	D 5204 T	2.0	2010.10 -		<b>410765.90D ▲</b>
D5	D 5244 T8, D 5244 T13	2.4	2006.03 -	Schaltgetriebe	<b>4816.90D</b>
D5	D 5244 T8, D 5244 T13	2.4	2006.03 -	Automatikgetriebe	<b>4818.90D</b>
T5	B 5254 T3, B 5254 T7	2.5	2006.03 -		<b>4489.90D</b>
<b>S 40 I</b>					
1.6	B 4164 S, B 4164 S2	1.6	1995.09 - 2003.12		<b>4272.90D</b>
1.8	B 4184 S, B 4184 S2, B 4184 S3, B 4184 S9	1.8	1995.07 - 2003.12		<b>4272.90D</b>
1.8 i	B 4184 SJ, B 4184 SM	1.8	1998.03 - 2003.12		<b>4637.82D</b>
1.9 DI	D 4192 T2, D 4192 T3, D 4192 T4	1.9	1999.03 - 2003.12		<b>3470.89D50</b>
1.9 T4	B 4194 T, B 4194 T2	1.9	1997.05 - 2000.07		<b>4272.90D</b>
1.9 TD	D 4192 T	1.9	1995.07 - 1999.08		<b>3470.89D50</b>
2.0	B 4204 S, B 4204 S2	2.0	1995.07 - 2003.12		<b>4272.90D</b>
2.0 T	B 4204 T, B 4204 T2, B 4204 T3	2.0	1997.10 - 2003.12		<b>4272.90D</b>
2.0 T4	B 4204 T5	2.0	2000.07 - 2003.12		<b>4272.90D</b>
<b>S 40 II</b>					
1.6	B 4164 S3	1.6	2005.01 -		<b>4483.82D</b>
2.4	B 5244 S, B 5244 S4, B 5244 S5	2.4	2004.01 -		<b>4489.90D</b>
2.4 D5	D 5244 T8, D 5244 T13	2.4	2006.03 -	Schaltgetriebe	<b>4816.90D</b>
2.4 D5	D 5244 T8, D 5244 T13	2.4	2006.03 -	Automatikgetriebe	<b>4818.90D</b>
D3	D 5204 T5	2.0	2010.10 -		<b>410765.90D ▲</b>
D4	D 5204 T	2.0	2010.10 -		<b>410765.90D ▲</b>
T5	B 5254 T3, B 5254 T7	2.5	2004.01 -		<b>4489.90D</b>
<b>S 60</b>					
2.0 T	B 5204 T5	2.0	2001.09 - 2001.12		<b>4272.90D</b>
2.0 T	B 5204 T5	2.0	2002.01 - 2004.12		<b>4817.90D</b>
2.0 T	B 5204 T5	2.0	2005.01 - 2010.04		<b>4818.90D</b>
2.3 T5	B 5234 T7	2.3	2000.07 - 2002.09	ohne Gehäuse	<b>4272.90D</b>
2.3 T5	B 5234 T7	2.3	2000.07 - 2002.09	mit Gehäuse	<b>4817.90D</b>
2.4	B 5244 S	2.4	2000.11 - 2002.12		<b>4272.90D</b>
2.4	B 5244 S2	2.4	2000.11 - 2010.04		<b>4272.90D</b>
2.4	B 5244 S	2.4	2003.01 - 2010.04		<b>4816.90D</b>
2.4	B 5244 T5	2.4	2004.02 - 2004.08		<b>4817.90D</b>
2.4	B 5244 T5	2.4	2004.09 - 2010.04		<b>4818.90D</b>
2.4	B 5244 T4	2.4	2005.01 - 2006.10		<b>4818.90D</b>
2.4 Bifuel	B 5244 SG	2.4	2002.06 - 2002.12		<b>4272.90D</b>
2.4 Bifuel	B 5244 SG	2.4	2003.01 - 2010.04		<b>4816.90D</b>
2.4 D	D 5244 T2, D 5244 T5, D 5244 T6, D 5244 T7	2.4	2001.12 - 2010.04		<b>4816.90D</b>
2.4 D5	D 5244 T, D 5244 T4	2.4	2001.07 - 2010.04		<b>4816.90D</b>
2.4 T	B 5244 T3	2.4	2000.11 - 2001.12		<b>4272.90D</b>
2.4 T	B 5244 T3	2.4	2002.01 - 2004.12		<b>4817.90D</b>
2.4 T	B 5244 T3	2.4	2005.01 - 2010.04		<b>4818.90D</b>
2.4 T5	B 5244 T5	2.4	2004.04 - 2004.12		<b>4817.90D</b>
2.4 T5	B 5244 T5	2.4	2005.01 - 2010.04		<b>4818.90D</b>
2.5	B 5254 T4	2.5	2003.09 - 2004.12		<b>4817.90D</b>
2.5	B 5254 T4	2.5	2005.01 - 2010.04		<b>4818.90D</b>
2.5 T	B 5254 T2	2.5	2004.02 - 2004.12		<b>4817.90D</b>
2.5 T	B 5254 T2	2.5	2005.01 - 2010.04		<b>4818.90D</b>
R 2.5 T	B 5254 T4	2.5	2003.03 - 2004.12		<b>4817.90D</b>
R 2.5 T	B 5254 T4	2.5	2005.01 - 2010.04		<b>4818.90D</b>
T5	B 5234 T3	2.3	2000.11 - 2010.04		<b>4272.90D</b>

# VOLVO

	Engine	Ltr.	Year	Restriction*	Thermostat
<b>S 60 II</b>					
D3	D 5204 T2, D 5204 T3, D 5204 T7	2.0	2010.04 -		410765.90D ▲
D4	D 5204 T3	2.0	2012.05 -		410765.90D ▲
D5	D 5244 T10, D 5244 T15, D 5244 T11	2.4	2010.04 -		410765.90D ▲
T6	B 6304 T4	3.0	2010.04 -		4831.90D ▲
<b>S 70</b>					
2.0	B 5202 S, B 5202 F, B 5204 T	2.0	1997.01 - 2000.11		4272.90D
2.3	B 5234 T7	2.3	1999.04 - 2000.09		4272.90D
2.3 T-5	B 5234 T3, B 5234 T4	2.3	1996.11 - 2000.11		4272.90D
2.3 T-5 R	B 5234 T2	2.3	1996.11 - 1998.09		4272.90D
2.3 Turbo	B 5234 FT+	2.3	1997.01 - 2000.11		4272.90D
2.4	B 5244 S, B 5252 FS, B 5254 S	2.4	1997.01 - 2000.11		4272.90D
2.4 Blu-Fuel	B 5244 SG, B 5244 S2	2.4	1997.07 - 2000.09		4272.90D
2.4 T5	B 5254 T	2.4	1996.11 - 1999.04		4272.90D
2.4 Turbo	B 5254 T, B 5244 T	2.4	1997.01 - 2000.11		4272.90D
2.5	B 5252 FS, B 5254 S	2.5	1997.01 - 2000.11		4272.90D
2.5 Bifuel	B 5244 SG, GB 5252 S	2.5	1998.10 - 2000.11		4272.90D
2.5 TDI	D 5252 T	2.5	1997.01 - 2000.11		4116.87D1
<b>S 80</b>					
2.0	B 5204 T4	2.0	1998.06 - 2006.07		4272.90D
2.0 T	B 5204 T3	2.0	1998.06 - 2006.07		4272.90D
2.0 T	B 5204 T5	2.0	1999.12 - 2001.08		4272.90D
2.0 T	B 5204 T5	2.0	2001.09 - 2004.04		4817.90D
2.0 T	B 5204 T5	2.0	2004.09 - 2006.07		4818.90D
2.3 R	B 5234 T7	2.3	2000.04 - 2001.12		4272.90D
2.3 R	B 5234 T7	2.3	2002.01 - 2004.12		4817.90D
2.3 R	B 5234 T7	2.3	2005.01 - 2005.08		4818.90D
2.4	B 5244 S, B 5244 S2	2.4	1999.01 - 2002.12		4272.90D
2.4	B 5244 S, B 5244 S2	2.4	2003.01 - 2006.07		4816.90D
2.4 Bifuel	B 5244 SG2	2.4	2001.09 - 2002.12		4272.90D
2.4 Bifuel	B 5244 SG2	2.4	2003.01 - 2006.07		4816.90D
2.4 D	D 5244 T2	2.4	2001.10 - 2006.07		4816.90D
2.4 D5	D 5244 T	2.4	2001.08 - 2006.07		4816.90D
2.4 LTP	B 5244 T4	2.4	2004.06 - 2006.07		4818.90D
2.4 T	B 5244 T3	2.4	2000.06 - 2001.12		4272.90D
2.4 T	B 5244 T3	2.4	2002.01 - 2004.12		4817.90D
2.4 T	B 5244 T3	2.4	2005.01 - 2006.07		4818.90D
2.4 T5	B 5244 T3	2.4	2000.04 - 2001.12		4272.90D
2.4 T5	B 5244 T3	2.4	2002.01 - 2003.09		4817.90D
2.5 T	B 5254 T2	2.5	2003.03 - 2004.12		4817.90D
2.5 T	B 5254 T2	2.5	2005.01 - 2006.07		4818.90D
2.5 TDI	D 5252 T	2.5	1999.01 - 2006.07		4116.87D1
2.8 T6	B 6284 T	2.8	1998.05 - 2006.07		4206.90D
2.9	B 6294 S, B 6304 S3	2.9	1998.05 - 2006.07		4206.90D
3.0	B 6294 S2	3.0	2001.06 - 2006.07		4206.90D
3.0 T6	B 6294 T	3.0	2001.06 - 2006.07		4206.90D
<b>S 80 II</b>					
2.4 D	D 5244 T, D 5244 T5	2.4	2006.03 -		4816.90D
2.5 T	B 5254 T6, B 5254 T10	2.5	2006.03 -		4489.90D
2.5 T FlexFuel	B 5254 T8, B 5254 T11	2.5	2008.05 -		4489.90D
3.2	B 6324 S, B 6324 S5	3.2	2006.03 -		4831.90D ▲
D3	D 5204 T7	2.0	2012.05 -		410765.90D ▲

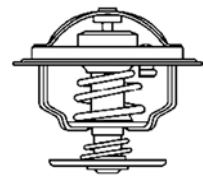

# VOLVO

	Engine	Ltr.	Year	Restriction*	Thermostat
D3 / D4	D 5204 T2, D 5204 T3	2.0	2010.01 -		410765.90D ▲
D5	D 5244 T4	2.4	2006.03 -		4816.90D
D5	D 5244 T10, D 5244 T11, D 5244 T15	2.4	2011.01 -		410765.90D ▲
T6	B 6304 T2, B 6304 T4	3.0	2007.01 -		4831.90D ▲
<b>S 90</b>					
2.5	B 6244 FS, B 6254 FS	2.5	1996.11 - 1998.10		4272.90D
2.9	B 6304 G, B 6304 S2	2.9	1997.01 - 1998.05		4272.90D
<b>V 40</b>					
1.6	B 4164 S, B 4164 S2	1.6	1995.12 - 2004.06		4272.90D
1.8	B 4184 S, B 4184 S2, B 4184 S3, B 4184 S9	1.8	1995.07 - 2004.06		4272.90D
1.8 Bi-Fuel	B 4184 S9	1.8	1999.11 - 2003.08		4272.90D
1.8 Blu-Fuel	B 4184 S2	1.8	2001.06 - 2003.08		4272.90D
1.8 i	B 4184 SJ, B 4184 SM	1.8	1998.03 - 2004.06		4637.82D
1.9 DI	D 4192 T2, D 4192 T3, D 4192 T4	1.9	1999.03 - 2004.06		3470.89D50
1.9 T4	B 4194 T	1.9	1997.05 - 2000.07		4272.90D
1.9 TD	D 4192 T	1.9	1995.07 - 1999.08		3470.89D50
2.0	B 4204 S, B 4204 S2	2.0	1995.07 - 2004.06		4272.90D
2.0 T	B 4204 T, B 4204 T2, B 4204 T3	2.0	1997.10 - 2004.06		4272.90D
2.0 T4	B 4204 T5	2.0	2000.07 - 2004.06		4272.90D
D3	D 5204 T6	2.0	2012.03 -		410765.90D ▲
D4	D 5204 T4	2.0	2012.03 -		410765.90D ▲
T4	B 5204 T8	2.0	2013.07 -		410765.90D ▲
T5	B 5204 T9	2.0	2013.03 -		410765.90D ▲
<b>V 50</b>					
1.6	B 4164 S3	1.6	2005.01 -		4483.82D
2.4	B 5244 S4, B 5244 S5	2.4	2004.04 -		4489.90D
2.4 D5	D 5244 T8, D 5244 T13	2.4	2006.03 -	Schaltgetriebe	4816.90D
2.4 D5	D 5244 T8, D 5244 T13	2.4	2006.03 -	Automatikgetriebe	4818.90D
2.4 Tdi	D 5244 T9	2.4	2007.05 -	Schaltgetriebe	4816.90D
2.4 Tdi	D 5244 T9	2.4	2007.05 -	Automatikgetriebe	4818.90D
D3	D 5204 T5	2.0	2010.10 -		410765.90D ▲
D4	D 5204 T	2.0	2010.10 -		410765.90D ▲
T5	B 5254 T3, B 5254 T7	2.5	2004.04 -		4489.90D
<b>V 60</b>					
2.4 D5	D 5244 T15, D 5244 T11	2.4	2011.06 -		410765.90D ▲
2.4 Hybrid	D 5244 T15	2.4	2012.06 -		410765.90D ▲
D3	D 5204 T7	2.0	2012.12 -		410765.90D ▲
D3 / D4	D 5204 T2, D 5204 T3	2.0	2010.09 -		410765.90D ▲
D4	D 5244 T17	2.4	2012.12 -		410765.90D ▲
D5	D 5244 T10	2.4	2010.09 -		410765.90D ▲
T6	B 6304 T4	3.0	2010.09 -		4831.90D ▲
<b>V 70 I</b>					
2.0	B 5204 F, B 5202 S, B 5204 T2, B 5204 T4	2.0	1997.01 - 2000.03		4272.90D
2.0 Turbo	B 5204 T, B 5204 T3	2.0	1997.01 - 2000.03		4272.90D
2.3	B 5234 T3, B 5234 T7, B 5234 T8	2.3	1997.04 - 2000.02		4272.90D
2.3 T	B 5234 FT+	2.3	1997.04 - 2000.03		4272.90D
2.3 T-5	B 5234 T3	2.3	1997.01 - 2000.03		4272.90D
2.3 Turbo	B 5234 FT+	2.3	1997.01 - 2000.03		4272.90D

# Thermostats

## VOLVO

	Engine	Ltr.	Year	Restriction*	Thermostat
2.4	B 5244 S, B 5244 S2, B 5254 S, B 5244 SG2	2.4	1997.01 - 2000.05		4272.90D
2.4 Bifuel	B 5244 SG	2.4	1999.08 - 2000.03		4272.90D
2.4 Turbo	B 5244 T, B 5244 T2, B 5254 T	2.4	1997.01 - 2000.03		4272.90D
2.5	B 5252 FS, B 5254 S	2.5	1997.01 - 2000.03		4272.90D
2.5 Bifuel	GB 5252 S	2.5	1998.10 - 1999.08		4272.90D
2.5 TDI	D 5252 T	2.5	1996.11 - 2000.05		4116.87D1
2.5 Turbo	B 5254 T, B 5244 T	2.5	1997.01 - 2000.05		4272.90D
<b>V 70 II</b>					
2.0 T	B 5204 T5	2.0	2001.07 - 2001.08		4272.90D
2.0 T	B 5204 T5	2.0	2001.09 - 2004.04		4817.90D
2.0 T	B 5204 T5	2.0	2004.09 - 2007.08		4818.90D
2.3	B 5234 T7, B 5234 T8	2.3	2000.10 - 2001.12		4272.90D
2.3	B 5234 T7, B 5234 T8	2.3	2002.01 - 2004.09		4817.90D
2.3 T5	B 5234 T3, B 5234 T4	2.3	2000.03 - 2001.12		4272.90D
2.3 T5	B 5234 T3, B 5234 T4	2.3	2002.01 - 2004.12		4817.90D
2.3 T5	B 5234 T3, B 5234 T4	2.3	2005.01 - 2007.08		4818.90D
2.4	B 5244 S, B 5244 S2	2.4	2000.03 - 2002.12		4272.90D
2.4	B 5244 S, B 5244 S2	2.4	2003.01 - 2002.12		4816.90D
2.4 Bifuel	B 5244 SG2	2.4	2001.09 - 2002.12		4272.90D
2.4 Bifuel	B 5244 SG2	2.4	2003.01 - 2007.08		4816.90D
2.4 D	D 5244 T2	2.4	2001.12 - 2007.08		4816.90D
2.4 D	D 5244 T7	2.4	2005.05 - 2007.08		4818.90D
2.4 D5	D 5244 T	2.4	2001.08 - 2007.08		4816.90D
2.4 D5	D 5244 T2, D 5244 T4, D 5244 T5	2.4	2001.08 - 2007.08		4818.90D
2.4 T	B 5244 T3	2.4	2000.03 - 2001.12		4272.90D
2.4 T	B 5244 T3	2.4	2002.01 - 2004.12		4817.90D
2.4 T	B 5244 T3	2.4	2005.01 - 2007.08		4818.90D
2.4 T5	B 5244 T5	2.4	2004.04 - 2004.08		4817.90D
2.4 T5	B 5244 T5	2.4	2004.09 - 2007.08		4818.90D
2.5 R Sport	B 5254 T4	2.5	2002.12 - 2004.08		4817.90D
2.5 R Sport	B 5254 T4	2.5	2004.09 - 2007.08		4818.90D
2.5 T	B 5254 T2	2.5	2002.09 - 2004.08		4817.90D
2.5 T	B 5254 T2	2.5	2004.09 - 2007.08		4818.90D
2.5 TDI	D 5252 T	2.5	2000.03 - 2007.08		4116.87D1
R 2.5 T	B 5254 T4	2.5	2003.03 - 2004.08		4817.90D
R 2.5 T	B 5254 T4	2.5	2004.09 - 2007.08		4818.90D
<b>V 70 III</b>					
2.4 D	D 5244 T5	2.4	2007.08 -		4816.90D
2.5 T	B 5254 T6, B 5254 T10	2.5	2007.08 -		4489.90D
2.5 T FlexiFuel	B 5254 T8, B 5254 T11	2.5	2008.05 -		4489.90D
3.2	B 6324 S, B 6324 S5	3.2	2007.08 -		4831.90D ▲
D3 / D4	D 5204 T2, D 5204 T3	2.0	2010.03 -		410765.90D ▲
D5	D 5244 T4	2.4	2007.08 -		4816.90D
D5	D 5244 T10, D 5244 T15, D 5244 T11	2.4	2011.01 -		410765.90D ▲
T6	B 6304 T2, B 6304 T4	3.0	2007.08 -		4831.90D ▲
<b>V 90</b>					
2.5	B 6244 FS, B 6254 FS	2.5	1996.11 - 1997.10		4272.90D
2.9	B 6304 G, B 6304 S2	2.9	1997.01 - 1998.12		4272.90D

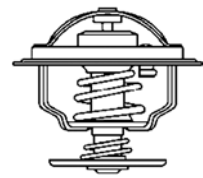

# VOLVO

	Engine	Ltr.	Year	Restriction*	Thermostat
<b>XC 60</b>					
2.4 D	D 5244 T14	2.4	2009.07 -	Fahrgestellnummer 135000→	<b>410765.90D ▲</b>
2.4 D / D3 / D4	D 5244 T16, D 5244 T17	2.4	2008.05 -	Fahrgestellnummer 135000→	<b>410765.90D ▲</b>
2.4 D / D3 / D4	D 5244 T5	2.4	2008.05 -		<b>4816.90D</b>
3.2	B 6324 S, B 6324 S5	3.2	2009.07 -		<b>4831.90D ▲</b>
D3 / D4	D 5204 T2, D 5204 T3	2.0	2010.03 -		<b>410765.90D ▲</b>
D5	D 5244 T4	2.4	2008.05 -		<b>4816.90D</b>
D5	D 5244 T10	2.4	2011.01 -	Fahrgestellnummer 135000→	<b>410765.90D ▲</b>
D5	D 5244 T11, D 5244 T15	2.4	2011.06 -		<b>410765.90D ▲</b>
T6	B 6304 T2, B 6304 T4	3.0	2008.05 -		<b>4831.90D ▲</b>
T6		3.0	2010.03 -		<b>4831.90D ▲</b>
<b>XC 70</b>					
2.4 D5	D 5244 T	2.4	2002.09 - 2007.08		<b>4816.90D</b>
2.4 D5	D 5244 T4	2.4	2005.12 - 2007.08		<b>4818.90D</b>
2.4 T	B 5254 T	2.4	1997.11 - 2002.09		<b>4272.90D</b>
2.4 T	B 5244 T3	2.4	2000.03 - 2001.12		<b>4272.90D</b>
2.4 T	B 5244 T3	2.4	2002.01 - 2002.09		<b>4817.90D</b>
2.5 T	B 5254 T2	2.5	2002.09 - 2004.08		<b>4817.90D</b>
2.5 T	B 5254 T2	2.5	2004.09 - 2007.08		<b>4818.90D</b>
<b>XC 70 II</b>					
2.4 D / D4	D 5244 T5	2.4	2007.08 -		<b>4816.90D</b>
3.2	B 6324 S, B 6324 S5	3.2	2007.08 -		<b>4831.90D ▲</b>
D3	D 5204 T2, D 5204 T3	2.0	2011.08 -		<b>410765.90D ▲</b>
D5	D 5244 T4	2.4	2007.08 -		<b>4816.90D</b>
D5	D 5244 T10	2.4	2011.01 -		<b>410765.90D ▲</b>
D5	D 5244 T15, D 5244 T11	2.4	2011.06 -		<b>410765.90D ▲</b>
T6	B 6304 T2, B 6304 T4	3.0	2008.01 -		<b>4831.90D ▲</b>
<b>XC 90</b>					
2.5 T	B 5254 T2	2.5	2002.10 - 2004.12		<b>4817.90D</b>
2.5 T	B 5254 T2	2.5	2005.01 -		<b>4818.90D</b>
3.2	B 6324 S, B 6324 S5	3.2	2006.05 -		<b>4831.90D ▲</b>
D3 / D5	D 5244 T5	2.5	2009.04 -		<b>4818.90D</b>
D5	D 5244 T, D 5244 T5	2.4	2002.10 -		<b>4816.90D</b>
D5	D 5244 T4, D 5244 T18	2.4	2006.05 -		<b>4818.90D</b>
T6	B 6294 T	2.9	2002.10 -		<b>4206.90D</b>

# WARTBURG

Engine

Ltr.

Year

Restriction\*

Thermostat

## Barkas B 1000

1.0	H362-21	1.0	1967.04 - 1991.12	Dichtring	003187
1.0	H362-21	1.0	1967.04 - 1991.12		3017.83

## Trabant 1.1

1.1	4V05,9 / 7,5GRF	1.1	1990.05 - 1991.12		4253.87D
-----	-----------------	-----	-------------------	--	----------

## Wartburg 353

1.0	353,18	1.0	1966.06 - 1989.01	Dichtring	003187
1.0	353,18	1.0	1966.06 - 1989.01		3017.83
1.0	1A	1.0	1967.10 - 1969.04	Dichtring	003187
1.0	1A	1.0	1967.10 - 1969.04		3017.83

## 353

1.3	4V07,2, 7,5GRF	1.3	1988.09 - 1991.05		4264.84D
-----	----------------	-----	-------------------	--	----------

## ALFA ROMEO

Engine

Ltr.

Year

Restriction\*

Thermaswitches

### 145 (930)

1.6 i.e.	AR 33201	1.6	1994.10 - 1996.12	ohne Klimaanlage	6031.92D
1.7 i.e. 16V	AR 33401	1.7	1994.10 - 1996.12	ohne Klimaanlage	6031.92D

### 146 (930)

1.6 i.e.	AR 33201	1.6	1994.12 - 1996.12	ohne Klimaanlage	6031.92D
1.7 i.e. 16V	AR 33401	1.7	1994.12 - 1996.12	ohne Klimaanlage	6031.92D

### 155 (167)

1.6 16V T.S.	AR 67601	1.6	1996.05 - 1997.12	mit Klimaanlage	6035.92D
1.7 T.S.	AR 67103, AR 67105	1.7	1993.04 - 1996.04	ohne Klimaanlage	6031.92D
1.7 T.S. 16V	AR 67106	1.7	1996.05 - 1997.12	mit Klimaanlage	6035.92D
1.8 T.S.	AR 67101	1.8	1992.02 - 1993.06	ohne Klimaanlage	6031.92D
1.8 T.S. Sport	AR 67101, AR 67102	1.8	1992.01 - 1996.12	ohne Klimaanlage	6031.92D
2.0 T.S. 16V (167.A2G)	AR 67204	2.0	1995.03 - 1997.12		6035.92D
2.5 TD (167.A1A)	VM 07 B, VM 31 B	2.5	1993.04 - 1997.12		6035.92D
2.5 V6	AR 67301, AR 67302, AR 67303	2.5	1992.02 - 1997.12	ohne Klimaanlage	6031.92D

### ALFASUD

1.2	AR 30102, AR 30102 S	1.2	1972.06 - 1984.09		6010.95D
1.2 ti	AR 30104	1.2	1973.11 - 1984.09		6010.95D
1.3	AR 30160, AR 30180, AR 30184	1.3	1978.01 - 1979.07 1976.09 - 1981.12		6010.92D 6010.95D
1.3 (901.F0)	AR 30180	1.3	1978.01 - 1980.02		6010.95D
1.3 SC/ti Super	AR 30164	1.3	1977.09 - 1984.09		6010.95D
1.3 Super (901.F2)	AR 30160	1.3	1979.01 - 1984.09		6010.95D
1.3 ti (901.G0)	AR 30184	1.3	1977.09 - 1984.09		6010.95D
1.4	AR 30164, AR 30168	1.4	1978.05 - 1989.12		6010.95D
1.5	AR 30124, AR 30128, AR 30146	1.5	1978.05 - 1987.12		6010.95D
1.7	AR 30550	1.7	1987.03 - 1989.12		6010.95D
1.7 i.e.	AR 30558	1.7	1987.10 - 1989.12		6010.95D

### ALFETTA

1.6	AR 01600	1.6	1975.01 - 1984.12		6010.95D
1.8	AR 01608, AR 01608 X, AR 01678	1.8	1974.01 - 1984.12		6010.95D
2.0	AR 01623, AR 01655, AR 01713, AR 10520	2.0	1977.03 - 1986.01		6010.95D
2.0 TD	VM4HT/2	2.0	1979.10 - 1983.03		6010.82D
2.4 TD	VM4HT 2.4	2.4	1983.04 - 1984.12		6010.82D

### GIULIETTA

1.3 (116.44A)	AR 01644	1.3	1977.10 - 1983.06		6010.95D
1.6 (116.50B)	AR 01600	1.6	1977.10 - 1985.04		6010.95D
1.8 (116.AA, 116.AB)	AR 01678	1.8	1979.04 - 1985.04		6010.95D
1.8 Turbo	AR 01354	1.8	1984.01 - 1985.12		6010.95D
2.0 (116.A1A)	AR 01655, AR 11671	2.0	1980.06 - 1985.04		6010.95D
2.0 TD	VM 4 HT	2.0	1983.01 - 1985.12		6010.82D
2.0 Turbo	AR 01699	2.0	1983.07 - 1984.06		6010.95D

### GTV (916)

2.0 T.SPARK 16V (916.C2__, 916C2C00)	AR 16201, AR 32310	2.0	1995.06 -		6035.92D
2.0 T.SPARK 16V (916C2C)	AR 32301	2.0	1998.05 - 2000.08		6035.92D
2.0 V6 Turbo (916.C2A)	AR 16202	2.0	1995.06 -		6035.92D
3.0 V6 24V	AR 16102, AR 16105	3.0	1996.10 - 2000.10		6035.92D

### MONTREAL

2.6 (105,64)	AR 10832	2.6	1972.12 - 1979.03		6010.95D
--------------	----------	-----	-------------------	--	----------



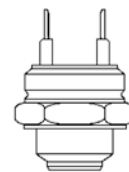

# ALFA ROMEO

	Engine	Ltr.	Year	Restriction*	Thermaswitches
<b>SPIDER (916)</b>					
2.0 T.SPARK 16V	AR 16201, AR 32301, AR 32310	2.0	1995.06 - 2005.04		<b>6035.92D</b>
2.0 V6 Turbo	AR 16202	2.0	1998.05 - 2005.04		<b>6035.92D</b>
3.0 V6	AR 16101, AR 16105	3.0	1995.06 - 2005.04		<b>6035.92D</b>
3.0 V6 24V	AR 16102	3.0	1999.01 - 2000.10		<b>6035.92D</b>
3.2 V6 24V	936 A6.000	3.2	2003.04 - 2005.04		<b>6035.92D</b>

# AUDI

	Engine	Ltr.	Year	Restriction*	Thermaswitches
<b>80 (quattro)</b>					
1.3	EP, FY, FZ, ZA, ZF	1.3	1972.05 - 1978.07 1972.05 - 1986.07		6010.92D 6024.95D
1.4	SE	1.4	1986.08 - 1988.07 1986.08 - 1988.07		6017.95D 6024.95D
1.5	YJ, ZB, ZC	1.5	1972.05 - 1976.07		6010.92D
1.6	ABB, ABM, DT, PP, RN, SA, WV, YN, YP, YT, YY	1.6	1975.09 - 1978.07 1986.02 - 1994.12 1975.09 - 1994.12		6010.92D 6017.95D 6024.95D
1.6 D	CR, JK	1.6	1980.08 - 1991.08 1980.08 - 1991.08		6017.95D 6024.95D
1.6 E	ADA	1.6	1993.06 - 1996.01 1993.06 - 1996.01		6017.95D 6024.95D
1.6 GLE	YZ	1.6	1979.01 - 1986.12		6024.95D
1.6 GT	XX	1.6	1973.09 - 1976.07		6010.92D
1.6 GTE	YS	1.6	1976.01 - 1978.07 1976.01 - 1978.07		6010.92D 6024.95D
1.6 TD	CY, RA, SB	1.6	1981.08 - 1991.08 1981.08 - 1991.08		6017.95D 6024.95D
1.8	DS, JN, RU, SD, SF	1.8	1983.01 - 1990.01 1983.01 - 1990.08		6017.95D 6024.95D
1.8 CC	JN, JV, NE	1.8	1984.08 - 1986.08		6024.95D
1.8 E	DZ	1.8	1986.06 - 1991.08		6024.95D
1.8 GTE	DZ, PV	1.8	1984.10 - 1986.08 1984.08 - 1986.08		6017.95D 6024.95D
1.8 S	JN, NE, PM, SF	1.8	1986.09 - 1991.10		6024.95D
1.9 CD-5S	WN	1.9	1981.09 - 1983.07		6024.95D
1.9 D	1Y	1.9	1989.08 - 1991.08 1989.08 - 1991.08		6017.95D 6024.95D
1.9 TD	AAZ	1.9	1991.09 - 1994.12 1991.09 - 1994.12		6017.95D 6024.95D
1.9 TDI	1Z	1.9	1991.09 - 1996.01 1991.09 - 1996.01		6017.95D 6024.95D
2.0	3A, AAD, ABT, HP, JS	2.0	1991.09 - 1996.01 1983.10 - 1984.09 1983.10 - 1996.01		6017.95D 6020.95D 6024.95D
2.0 E	3A, ABK	2.0	1991.09 - 1996.01 1988.08 - 1996.01		6017.95D 6024.95D
2.0 E 16V	6A, ACE	2.0	1990.03 - 1996.01 1992.04 - 1996.01		6017.95D 6024.95D
2.2	KK, KL, WE	2.2	1982.08 - 1984.07 1980.10 - 1983.07		6020.95D 6024.95D
2.3 E	NG	2.3	1991.09 - 1996.01 1991.09 - 1996.01		6017.95D 6024.95D
2.6	ABC	2.6	1992.06 - 1996.01 1992.06 - 1996.01		6017.95D 6024.95D
2.8	AAH	2.8	1991.09 - 1996.01 1991.09 - 1996.01		6017.95D 6024.95D
RS2	ADU	2.2	1994.03 - 1995.05		6017.95D
S2	ABY	2.2	1993.02 - 1995.07 1993.02 - 1995.07		6017.95D 6024.95D
<b>90 (quattro)</b>					
1.6 TD	CY, RA, SB	1.6	1985.10 - 1991.09 1985.10 - 1991.09		6017.95D 6024.95D
2.0	HP, JS, PS, SK	2.0	1984.10 - 1991.09 1984.10 - 1991.09		6017.95D 6024.95D

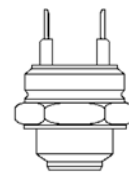

# AUDI

	Engine	Ltr.	Year	Restriction*	Thermaswitches
2.0 20 V	NM	2.0	1988.08 - 1991.09 1988.08 - 1991.09		6017.95D 6024.95D
2.2	HY, KV, KX	2.2	1984.10 - 1987.03 1984.10 - 1987.03		6017.95D 6024.95D
2.2 E	JT, KV	2.2	1984.11 - 1991.09		6024.95D
2.3 E	NG	2.3	1987.04 - 1991.09		6024.95D
2.3 E 20V	7A	2.3	1988.06 - 1991.09		6024.95D
<b>100 1968 --&gt; 1983</b>					
1.6	YM, YV	1.6	1976.08 - 1983.02 1975.01 - 1983.02 1976.08 - 1983.02	Chassis No →4382300000 Chassis No 4392000001→	6017.95D 6010.92D 6024.95D
1.8	ZU, ZV, ZX, ZZ	1.8	1968.11 - 1976.07		6010.92D
1.9	WH, ZJ, ZP	1.9	1980.08 - 1982.07 1970.07 - 1982.07 1980.08 - 1982.07	Chassis No →4382300000 Chassis No 4392000001→	6017.95D 6010.92D 6024.95D
2.0	WA	2.0	1976.06 - 1980.07 1976.06 - 1980.07	Chassis No →4382300000	6017.95D 6010.92D
2.0 D	CN	2.0	1978.08 - 1983.02 1978.08 - 1983.02 1978.08 - 1983.02	Chassis No →4382300000 Chassis No 4392000001→	6017.95D 6010.92D 6024.95D
2.1	WB, WC, WE, WG	2.1	1977.03 - 1983.02 1977.03 - 1983.02	Chassis No 4392000001→	6017.95D 6024.95D
<b>100 1982 --&gt; 1990 (quattro)</b>					
1.8	DR, DS, JW, NP, RS, SH	1.8	1982.08 - 1990.07 1982.08 - 1990.07		6017.95D 6024.95D
1.8 KAT	4B, PH	1.8	1985.03 - 1990.11 1985.03 - 1990.11		6017.95D 6024.95D
1.8 quattro KAT	4B, PH	1.8	1985.08 - 1990.11 1985.08 - 1990.11		6017.95D 6024.95D
1.9	WH	1.9	1982.08 - 1984.07 1982.08 - 1984.07		6017.95D 6024.95D
2.0	KP, RT, SL	2.0	1984.08 - 1990.11 1984.08 - 1990.11		6017.95D 6024.95D
2.0 D	CN	2.0	1982.08 - 1990.11 1982.08 - 1990.11		6017.95D 6024.95D
2.0 D Turbo	DE, NC	2.0	1982.08 - 1990.11 1982.08 - 1990.11		6017.95D 6024.95D
2.0 E	KP, RT	2.0	1985.01 - 1990.11 1985.01 - 1990.11		6017.95D 6024.95D
2.0 TD	DE, NC	2.0	1983.03 - 1990.11 1983.03 - 1990.11		6017.95D 6024.95D
2.1	WC	2.1	1982.08 - 1984.07 1982.08 - 1984.07		6017.95D 6024.95D
2.2	HX, KF, KU, KZ, WU	2.2	1982.08 - 1990.11 1982.08 - 1990.11		6017.95D 6024.95D
2.2 E	PX	2.2	1985.08 - 1986.07 1985.08 - 1986.07		6017.95D 6024.95D
2.2 E Turbo	MC	2.2	1986.08 - 1990.11 1986.08 - 1990.11		6017.95D 6024.95D

# AUDI

	Engine	Ltr.	Year	Restriction*	Thermaswitches
2.2 Turbo	MC	2.2	1986.08 - 1990.11 1986.08 - 1990.11		6017.95D 6024.95D
2.3	AAR, NF	2.3	1986.08 - 1990.11 1986.08 - 1990.11		6017.95D 6024.95D
2.3 E	AAR, NF	2.3	1986.08 - 1990.11 1986.08 - 1990.11		6017.95D 6024.95D
2.4 D	3D	2.4	1989.08 - 1991.07 1989.08 - 1991.07		6017.95D 6024.95D
2.5 TDI	1T	2.5	1990.01 - 1990.11 1990.01 - 1990.11		6017.95D 6024.95D
<b>100 1990 --&gt; 1994 (quattro)</b>					
2.0	AAE	2.0	1990.12 - 1994.06		6017.95D
2.0 E	AAD, AAE, ABK	2.0	1990.12 - 1994.06		6017.95D
2.0 E 16V	ACE	2.0	1992.01 - 1994.06 1992.01 - 1994.06		6017.95D 6024.95D
2.3 E	AAR	2.3	1990.12 - 1994.06		6017.95D
2.4 D	AAS	2.4	1990.12 - 1994.06		6017.95D
2.5 TDI	AAT, ABP	2.5	1990.12 - 1994.06		6017.95D
2.6	ABC, ACZ	2.6	1992.03 - 1994.06		6017.95D
2.8 E	AAH	2.8	1990.12 - 1994.06		6017.95D
S4 Turbo	AAN	2.2	1991.08 - 1994.06		6017.95D
S4 V8	ABH, AEC	4.2	1992.10 - 1994.06		6017.95D
<b>200 (quattro)</b>					
2.1 5 E	WC	2.1	1979.10 - 1984.07 1979.10 - 1984.07		6010.95D 6017.95D
2.1 5 T	WJ	2.1	1979.10 - 1982.08 1979.10 - 1982.08		6010.95D 6017.95D
2.1 Turbo	KG	2.1	1983.08 - 1988.01 1983.08 - 1988.01		6010.95D 6017.95D
2.2	KU	2.2	1984.08 - 1985.07 1984.08 - 1985.07		6010.95D 6017.95D
2.2 20V Turbo	3B	2.2	1989.03 - 1990.12		6017.95D
2.2 Turbo	1B, 2B, MC	2.2	1983.09 - 1991.12 1983.09 - 1991.12		6010.95D 6017.95D
2.3	NF	2.3	1986.11 - 1991.09 1986.11 - 1991.09		6010.95D 6017.95D
<b>A3 (8L)</b>					
1.6	AEH, AKL, APF	1.6	1996.09 - 2000.08 1996.09 - 2000.08		6037.95D 6039.95D
1.8	AGN, APG	1.8	1996.09 - 1996.09 -		6037.95D 6039.95D
1.8 T	AGU, AQA, ARZ, AUM	1.8	1996.12 - 1996.12 -		6037.95D 6039.95D
1.9 TDI	AGR, AHF, ALH, ASV	1.9	1996.09 - 2001.07 1996.09 - 2001.07		6037.95D 6039.95D
<b>A4 (quattro)</b>					
1.6	ADP, AHL, ALZ, ANA, ARM	1.6	1995.01 - 2000.11 1995.01 - 2000.11		6017.95D 6024.95D
1.8	ADR, APT, ARG, AVV	1.8	1995.01 - 2001.09 1995.01 - 2001.09		6017.95D 6024.95D
1.8 T	AEB, ANB, APU, ARK, AWT	1.8	1995.01 - 2001.09 1995.01 - 2001.09		6017.95D 6024.95D
1.9 TDI	1Z, AFN, AHH, AHU, AVG	1.9	1995.01 - 2001.09 1995.01 - 2001.09		6017.95D 6024.95D

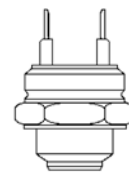

# AUDI

	Engine	Ltr.	Year	Restriction*	Thermaswitches
2.4	AGA, AJG, ALF, AML, AMM, APS, APZ, ARJ	2.4	1997.03 - 2001.09 1997.03 - 2001.09		6017.95D 6024.95D
2.6	ABC	2.6	1995.01 - 2001.09 1995.01 - 2001.09		6017.95D 6024.95D
2.8	AAH, ACK, ALG, AMX, APR, AQD	2.8	1995.01 - 2001.09 1995.01 - 2001.09		6017.95D 6024.95D
<b>A6 (quattro)</b>					
1.8	ADR	1.8	1995.12 - 1997.12		6017.95D
1.9 TDI	1Z, AHU	1.9	1994.06 - 1997.12		6017.95D
2.0	AAE, ABK, ADW	2.0	1994.06 - 1997.12		6017.95D
2.0 16V	ACE	2.0	1994.06 - 1997.12		6017.95D
2.3	AAR	2.3	1994.06 - 1995.12		6017.95D
2.4	AFM	2.4	1996.07 - 1997.12		6017.95D
2.5 TDI	AAT, AEL	2.5	1994.06 - 1997.12		6017.95D
2.6	ABC, ACZ	2.6	1994.06 - 1997.12		6017.95D
2.8	AAH, ACK, AEJ, AFC	2.8	1994.06 - 1997.12 1995.12 - 1997.12		6017.95D 6024.95D
S6 4.2	AEC	4.2	1994.06 - 1997.12		6017.95D
S6 Turbo	AAN	2.2	1994.06 - 1997.12		6017.95D
<b>A8 (quattro)</b>					
2.5 TDI	AFB, AKE, AKN	2.5	1997.01 - 2000.04 1997.01 - 2002.09		6017.95D 6087.87D
2.8	AAH, ACK, AEJ, ALG, AMX, APR, AQD	2.8	1994.03 - 2002.09 1994.03 - 1996.03 1996.04 - 2002.09		6017.95D 6024.95D 6087.87D
3.3 TDI	AKF	3.3	2000.06 - 2002.09		6087.87D
3.7	AEW, AKC, AKJ, AQG	3.7	1998.11 - 2002.09 1995.07 - 2002.09		6017.95D 6087.87D
4.2	ABZ, AKG, AQF, ARU, AUW, AUX	4.2	1998.11 - 2002.09 1994.03 - 2002.09		6017.95D 6087.87D
6.0 W12	AZC	6.0	2001.01 - 2002.09		6087.87D
S 8	AHC, AKH, AQH, AVP	4.2	1996.07 - 2002.09		6087.87D
<b>CABRIOLET</b>					
1.8	ADR	1.8	1997.01 - 2000.08 1997.01 - 2000.08		6017.95D 6024.95D
1.9 TDI	1Z, AHU	1.9	1995.06 - 2000.08 1995.06 - 2000.08		6017.95D 6024.95D
2.0 16V	ACE	2.0	1995.06 - 1996.07 1995.06 - 1996.07		6017.95D 6024.95D
2.0 E	ABK	2.0	1993.01 - 1998.07 1993.01 - 1998.07		6017.95D 6024.95D
2.3 E	NG	2.3	1991.05 - 1994.07 1991.05 - 1994.07		6017.95D 6024.95D
2.6	ABC, ACZ	2.6	1993.06 - 2000.08 1993.06 - 2000.08		6017.95D 6024.95D
2.8	AAH	2.8	1992.11 - 2000.08 1992.11 - 2000.08		6017.95D 6024.95D
<b>COUPE (quattro)</b>					
1.8	DD, DZ	1.8	1981.08 - 1983.07 1981.08 - 1991.07	Chassis No →85F220000 Chassis No 85G000001→	6024.95D 6017.95D

# Thermoswitch

## AUDI

	Engine	Ltr.	Year	Restriction*	Thermoswitches
1.8 GT	DS, DZ, JN, JV, PV, SF	1.8	1982.09 - 1988.10	Chassis No →85F220000	<b>6024.95D</b>
			1982.09 - 1988.10	Chassis No 85G000001→	<b>6017.95D</b>
1.9	WN	1.9	1980.08 - 1983.07	Chassis No →85F220000	<b>6024.95D</b>
			1980.08 - 1983.07	Chassis No 85G000001→	<b>6017.95D</b>
2.0	AAD, ABK, HP, JS, SK	2.0	1983.09 - 1988.04	Chassis No →85F220000	<b>6024.95D</b>
			1983.09 - 1996.12	Chassis No 85G000001→	<b>6017.95D</b>
2.0 16 V	ACE	2.0	1992.08 - 1996.12		<b>6017.95D</b>
2.0 20 V	NM	2.0	1989.08 - 1991.07		<b>6017.95D</b>
			1989.08 - 1991.07		<b>6024.95D</b>
2.1 GT	KE, KL	2.1	1982.09 - 1984.08	Chassis No →85F220000	<b>6024.95D</b>
			1982.09 - 1984.08	Chassis No 85G000001→	<b>6017.95D</b>
2.2	JT, KV	2.2	1984.10 - 1988.10	Chassis No →85F220000	<b>6024.95D</b>
			1984.10 - 1991.07	Chassis No 85G000001→	<b>6017.95D</b>
2.2 GT	HY, KV, KX	2.2	1981.07 - 1988.10	Chassis No →85F220000	<b>6024.95D</b>
			1981.07 - 1988.10	Chassis No 85G000001→	<b>6017.95D</b>
2.3	NG	2.3	1987.01 - 1988.10	Chassis No →85F220000	<b>6024.95D</b>
			1987.01 - 1996.12	Chassis No 85G000001→	<b>6017.95D</b>
2.3 20V	7A	2.3	1988.11 - 1996.12		<b>6017.95D</b>
2.6	ABC	2.6	1992.08 - 1996.12		<b>6017.95D</b>
2.8	AAH	2.8	1991.08 - 1996.12		<b>6017.95D</b>
S2	3B, ABY	2.2	1990.09 - 1996.12		<b>6017.95D</b>
<b>QUATTRO</b>					
2.1 20V Turbo	KW	2.1	1984.05 - 1987.07		<b>6024.95D</b>
2.1 Turbo	GV, WR	2.1	1980.07 - 1987.07	Chassis No →85-F-902000	<b>6010.95D</b>
			1980.07 - 1987.07	Chassis No 85-G-900001→	<b>6024.95D</b>
2.2 Turbo	1B, MB	2.2	1987.08 - 1989.07		<b>6017.95D</b>

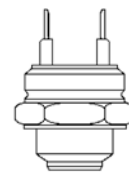

# AUTOBIANCHI

	Engine	Ltr.	Year	Restriction*	Thermaswitches
<b>A 112</b>					
0.9	A112A 5.000, A112B2.000	0.9	1969.10 - 1985.12		<b>6010.95D</b>
0.9 E	A112A 5.000	0.9	1973.01 - 1977.12		<b>6010.95D</b>
1.0 Abarth	A112A1.000, A112A2.000	1.0	1971.09 - 1984.12		<b>6010.95D</b>
1.0 E,Elite,LX	A112B1.000	1.0	1977.11 - 1985.12		<b>6010.95D</b>
<b>Y 10</b>					
1.0	156A.000, 156A2.000, 156A2.246, 156A3.000	1.0	1985.03 - 1991.12		<b>6031.92D</b>
1.0 Turbo	156A1.000	1.0	1985.03 -		<b>6031.92D</b>
1.1	156C.000	1.1	1989.06 - 1989.06 -	ohne Klimaanlage mit Klimaanlage	<b>6031.92D</b> <b>6035.92D</b>
1.1 i.e.	156C.046	1.1	1990.09 -	ohne Klimaanlage	<b>6031.92D</b>

# CITROËN

Engine

Ltr.

Year

Restriction\*

Thermaswitches

## AX

1.3 Sport	M4A	1.3	1987.04 - 1988.12		6010.95D
10 E	C3A	1.0	1986.12 - 1988.12		6010.95D
11	H1A, H1B	1.1	1986.12 - 1994.04		6010.95D
14	KAY (TU3CP)	1.4	1986.12 - 1988.12		6010.95D

## BX

14	K1H (TU3A), KDY (TU3M), KDZ (TU3M/Z)	1.4	1989.01 - 1993.02		6010.88D
14 E	150A, 150C, 150F, K1G	1.4	1982.10 - 1993.02 1985.10 - 1989.05		6010.88D 6010.92D

## CX

20	829 A5	2.0	1985.08 - 1986.08		6010.95D
20 RE	829 A5	2.0	1985.08 - 1992.12		6010.95D
2000	829 A5, M20-616	2.0	1974.09 - 1985.08		6010.95D
2200	M22-617	2.2	1974.09 - 1976.07		6010.95D
2200 D	M22-621	2.2	1975.10 - 1979.02		6010.88D
2400	M23-623	2.3	1976.08 - 1980.06		6010.95D
2500 D	M25-629	2.5	1978.02 - 1985.08		6010.95D

## LNA

1.1	109/5E	1.1	1982.07 - 1985.04		6010.88D
-----	--------	-----	-------------------	--	----------

## VISA

0.6	V06/665	0.6	1982.07 - 1991.03		6010.92D
11 E	109/5F, 109K	1.1	1978.09 - 1991.03		6010.88D
14 GT	150B (XY8)	1.4	1982.03 - 1991.03		6010.88D



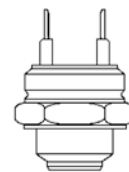

# DACIA

	Engine	Ltr.	Year	Restriction*	Thermaswitches
<b>1300</b>					
1.3	810-02/-99	1.3	1972.12 - 1983.05		<b>6010.92D</b>
<b>1310</b>					
1.3	810-02/-99	1.3	1983.05 -		<b>6010.92D</b>

**DAEWOO**

Engine

Ltr.

Year

Restriction\*

Thermoswitches

**NEXIA (KLETN)**

1.5	G15MF	1.5	1995.02 - 1997.08		<b>6010.92D</b>
-----	-------	-----	-------------------	--	-----------------

1.5 16V	A15MF	1.5	1995.02 - 1997.08		<b>6010.92D</b>
---------	-------	-----	-------------------	--	-----------------

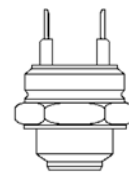

# FIAT

	Engine	Ltr.	Year	Restriction*	Thermaswitches
<b>124 Spider</b>					
1600 Sport (BS)		1.6	1969.11 - 1973.08		6010.92D
1600 Sport (BS1)	132 AC.000	1.6	1969.01 - 1974.12		6010.92D
1600 Sport (CS)	132 AC.000	1.6	1969.01 - 1974.12		6010.92D
1800 Rally Abarth (CSA)		1.7	1972.09 - 1975.07		6010.92D
1800 Sport (CS1)		1.8	1972.01 - 1977.12		6010.92D
1800 Sport (CS1)		1.7	1973.01 - 1975.07		6010.92D
<b>127</b>					
0.9	100 GL.000, 100 GL.048	0.9	1971.06 - 1983.05		6010.88D
1.0	127 A.000, 127 A1.000	1.0	1977.01 - 1986.12		6010.88D
1.3 Diesel	127 A5.000	1.3	1981.04 - 1986.12		6010.88D
1.3 Sport	127 A3.000	1.3	1981.12 - 1983.05		6010.88D
<b>128</b>					
1.1	128 A.000, 128 A.048	1.1	1969.03 - 1984.12		6010.88D
1.3	128 A1.000	1.3	1971.09 - 1984.12		6010.92D
<b>131</b>					
1.3 Mirafiori	131 A6.000	1.3	1974.10 - 1981.09 1974.10 - 1982.12		6010.88D 6010.92D
1.3 Mirafiori (AF)	131 A6.000	1.3	1975.03 - 1978.12		6010.88D
1.3 Super Mirafiori	131 B.000	1.3	1978.03 - 1980.12		6010.88D
1.4 Mirafiori	131 C.000, 131 C1.000	1.4	1980.11 - 1984.01		6010.88D
1.6	131 C2.000	1.6	1976.11 - 1985.04		6010.88D
1.6 (S)	131 A1.000	1.6	1974.10 - 1981.09		6010.88D
1.6 CL (AF1)	131 A1.000	1.6	1975.03 - 1978.12		6010.88D
1.6 Super	131 C3.000	1.6	1978.03 - 1984.01 1979.12 - 1981.12		6010.88D 6010.92D
1.6 Super Mirafiori (A)	131 B1.000	1.6	1979.03 - 1982.03		6010.88D
2.0 Racing	131 B2.000	2.0	1978.06 - 1981.12		6010.88D
2.0 Super	131 C4.000	2.0	1981.01 - 1984.12		6010.88D
2.5 Diesel	8144.61	2.5	1978.06 - 1984.02		6010.88D
2.5 Super Diesel (AF)	8144.61	2.5	1979.03 - 1984.12		6010.88D
<b>132</b>					
1.6	132 BB OA O, 132 C.000, 132 C6.000	1.6	1972.04 - 1982.12		6010.88D
1.7	132 B1.000	1.7	1972.04 - 1977.01		6010.88D
2.0	132 C2.000	2.0	1977.05 - 1981.06		6010.88D
2.0 GLS	132 C2.000	2.0	1976.01 - 1976.12		6010.92D
2.0 i.e.	132 C3.000	2.0	1980.01 - 1982.12		6010.88D
<b>ARGENTA (132A)</b>					
1600	132 D.000	1.6	1981.04 - 1985.12		6010.95D
2000	132 C2.000, 132 D1.000	2.0	1978.06 - 1985.12		6010.95D
2000 i.e.	132 C3.000	2.0	1981.06 - 1986.07		6010.95D
2500 Diesel	8144.61	2.5	1981.06 - 1985.11		6010.88D
2500 Turbodiesel	8144.61.500.81	2.4	1983.07 - 1985.08		6010.88D
<b>BRAVA, BRAVO (182)</b>					
1.2 16V 80	182 B2.000, 188 A5.000	1.2	1998.12 - 2001.10	ohne Klimaanlage	6031.92D
1.4 (182.AA)	182 A3.000	1.4	1995.10 - 2001.10 1995.10 - 2001.10	ohne Klimaanlage	6031.92D 6035.92D
1.4 (182.AG)	182 A5.000	1.4	1995.10 - 2001.10 1995.10 - 2001.10	ohne Klimaanlage mit Klimaanlage	6031.92D 6035.92D
1.4 (182.BG)	182 A5.000	1.4	1995.10 - 2001.10 1995.10 - 2001.10	ohne Klimaanlage mit Klimaanlage	6031.92D 6035.92D

# Thermoswitch

## FIAT

	Engine	Ltr.	Year	Restriction*	Thermoswitches
1.4 12 V	182 A3.000	1.4	1995.10 - 1998.08	ohne Klimaanlage	6031.92D
			1995.10 - 1998.08	mit Klimaanlage	6035.92D
1.6 16V	182 A4.000, 182 A6.000	1.6	1995.10 - 2001.10	ohne Klimaanlage	6031.92D
			1995.10 - 2001.10	mit Klimaanlage	6035.92D
1.8 GT	182 A2.000	1.8	1995.10 - 2001.10	ohne Klimaanlage	6031.92D
1.9 JTD	182 B9.000	1.9	2000.09 - 2001.10	mit Klimaanlage	6035.92D
1.9 JTD 105	182 B4.000	1.9	1998.12 - 2001.10		6031.92D
1.9 TD 100 S	182 A7.000	1.9	1996.03 - 2001.10	mit Klimaanlage	6035.92D
1.9 TD 75 S	182 A8.000	1.9	1996.03 - 2001.10	mit Klimaanlage	6035.92D
2.0 HGT 20V	182 A1.000	2.0	1995.10 - 1998.07	ohne Klimaanlage	6031.92D

### CINQUECENTO (170)

0.7 (170AA)	170 A.000	0.7	1991.12 - 1996.01		6031.97D
0.7 i (170AD)	170 A.046	0.7	1994.07 - 1998.01		6031.97D
0.9 (170AB)	170 A1.000	0.9	1991.07 - 1993.12		6031.97D
0.9 i.e. (170AC)	170 A1.046	0.9	1991.07 - 1993.12		6031.97D
0.9 i.e. S (170AF, 170CF)	1170 A1.000, 1170 A1.046	0.9	1991.07 - 1999.07		6031.97D
1.1 Sporting (170AH)	176 B2.000	1.1	1994.10 - 1998.01		6031.97D

### COUPE

1.8 16V	183 A1.000	1.8	1996.03 - 2000.08		6035.92D
2.0 16V	836 A3.000	2.0	1993.11 - 1996.08	ohne Klimaanlage	6031.92D
			1993.11 - 1996.08	mit Klimaanlage	6035.92D
2.0 16V Turbo	175 A1.000	2.0	1993.11 - 1996.08	ohne Klimaanlage	6031.92D
			1993.11 - 1996.08	mit Klimaanlage	6035.92D
2.0 20V	182 A1.000, 182 B3.000	2.0	1996.08 - 2000.08	ohne Klimaanlage	6031.92D
			1996.08 - 2000.08	mit Klimaanlage	6035.92D
2.0 20V Turbo	175 A3.000	2.0	1996.08 - 2000.08	ohne Klimaanlage	6031.92D
			1996.08 - 2000.08	mit Klimaanlage	6035.92D

### CROMA (154)

1600	154 A.048	1.6	1986.07 - 1989.06		6031.92D
2000 16V	154 E1.000	2.0	1992.08 - 1996.08		6035.92D
2000 CHT		2.0	1991.01 - 1992.09		6031.92D
2000 CHT (154.AC)	154 A1.000	2.0	1985.12 - 1989.02		6035.92D
2000 i.e.	154 C3.000, 154 C3.046, 834 B.000, 834 B.048, 834 B.146	2.0	1986.03 - 1996.08		6035.92D
2000 i.e. Turbo	154 A2.000, 154 C4.046, 834 C.146	2.0	1985.12 - 1996.08		6035.92D
2500 D	8144.67	2.5	1985.12 - 1989.12		6017.85D
2500 TD (154.AE)	8144.91.2000	2.4	1985.12 - 1989.08		6017.85D

### DUCATO (290)

2.0	170 D	2.0	1992.05 - 1994.05		6031.92D
-----	-------	-----	-------------------	--	----------

### DUNA (146 B)

60 1.1	146 A6.000	1.1	1987.01 - 1991.12		6031.92D
70 1.3	146 A5.000	1.3	1987.01 - 1991.12		6031.92D
DS 1.7	149 B3.000	1.7	1987.01 - 1991.12		6040.88

### ELBA

1.3		1.3	1986.04 - 1993.12		6031.92D
1.5	149 C1.000	1.5	1986.04 - 1996.12	149C1.000	6035.92D
1.6	159 A3.000	1.6	1989.04 - 1996.12		6035.92D
1.7 D	146 B2.000	1.7	1989.04 - 1996.12		6040.88

### FIORINO (127)

1050	127 A.000	1.0	1980.01 - 1987.12		6010.88D
------	-----------	-----	-------------------	--	----------

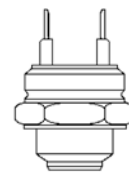

# FIAT

	Engine	Ltr.	Year	Restriction*	Thermaswitches
<b>FIORINO (146 Uno)</b>					
60 1.1	146 A9.000	1.1	1988.05 - 1993.12		<b>6031.92D</b>
60 1.7 D	146 B2.000, 149 B3.000	1.7	1988.05 - 2000.05		<b>6040.88</b>
65 1.7 TD	146 D7.000	1.7	1997.01 - 2001.05	ohne Klimaanlage	<b>6040.88</b>
70 1.3	146 A5.000	1.3	1988.01 - 1994.12		<b>6031.92D</b>
70 i.e. 1.4	146 C5.000, 146 D5.000	1.4	1994.05 - 2001.05		<b>6035.92D</b>
75 i.e. 1.5	149 C1.000	1.5	1988.05 - 1993.12 1988.05 - 1993.12		<b>6010.88D</b> <b>6031.92D</b>
75 i.e. 1.6	146 C6.000, 146 D6.000	1.6	1993.10 - 2001.05		<b>6035.92D</b>
<b>FIORINO (147)</b>					
1.0	127 A.000	1.0	1980.01 - 1987.12		<b>6010.88D</b>
1.1	146 A9.000	1.1	1986.11 - 1988.04		<b>6031.92D</b>
1.3	146 A5.000	1.3	1987.12 - 1993.08		<b>6031.92D</b>
1.3 D	127 A5.000	1.3	1982.03 - 1987.12		<b>6040.88</b>
<b>FIORINO (146 Uno)</b>					
1.4	146 D5.000	1.4	1994.05 - 2001.05		<b>6035.92D</b>
<b>FIORINO (147)</b>					
1.5	149 C1.000	1.5	1988.01 - 1993.08		<b>6031.92D</b>
<b>FIORINO (146 Uno)</b>					
1.6	146 C6.000, 146 D6.000	1.6	1994.01 - 2001.05		<b>6035.92D</b>
<b>FIORINO (147)</b>					
1.7 D	149 B2.000, 149 B3.000	1.7	1987.12 - 1990.12		<b>6010.88D</b>
<b>FIORINO (146 Uno)</b>					
1.7 TD	146 D7.000	1.7	1997.01 - 2001.05	ohne Klimaanlage	<b>6040.88</b>
<b>MAREA (185)</b>					
1.2 16V	182 B2.000	1.2	1998.10 - 1998.10 -	ohne Klimaanlage mit Klimaanlage	<b>6031.92D</b> <b>6035.92D</b>
1.4 80 12V	182 A3.000	1.4	1996.09 - 1996.09 -	ohne Klimaanlage mit Klimaanlage	<b>6031.92D</b> <b>6035.92D</b>
1.6 100 16V	182 A4.000	1.6	1996.09 - 1996.09 -	ohne Klimaanlage mit Klimaanlage	<b>6031.92D</b> <b>6035.92D</b>
1.6 100 16V Bipower	185 A3.000, 186 A4.000	1.6	1999.04 - 1999.04 -	ohne Klimaanlage mit Klimaanlage	<b>6031.92D</b> <b>6035.92D</b>
1.8 115 16V	182 A2.000	1.8	1996.09 - 1996.09 -	ohne Klimaanlage mit Klimaanlage	<b>6031.92D</b> <b>6035.92D</b>
1.9 TD 100	182 A7.000	1.9	1996.09 - 1996.09 -	ohne Klimaanlage mit Klimaanlage	<b>6031.92D</b> <b>6035.92D</b>
1.9 TD 75	182 A8.000	1.9	1996.09 -	mit Klimaanlage	<b>6035.92D</b>
2.0 150 20V	182 A1.000	2.0	1996.09 - 1999.04 1996.09 - 1999.04	ohne Klimaanlage mit Klimaanlage	<b>6031.92D</b> <b>6035.92D</b>
<b>PALIO</b>					
1.0		1.0	1996.04 -		<b>6031.92D</b>
1.2	176 A8.000, 178 B5.000, 178 E2.000	1.2	1998.06 - 1998.06 -	ohne Klimaanlage mit Klimaanlage	<b>6031.92D</b> <b>6035.92D</b>
1.2 (178DX.G1A)	178 B5.000	1.2	1996.04 - 2001.02 1996.04 - 2001.02	ohne Klimaanlage mit Klimaanlage	<b>6031.92D</b> <b>6035.92D</b>
1.2 (178DYA1A)	188 A4.000	1.2	2001.02 - 2001.02 -	ohne Klimaanlage mit Klimaanlage	<b>6031.92D</b> <b>6035.92D</b>
1.4	178 B2.000, 178 B2.016	1.4	1996.04 - 1996.04 -	ohne Klimaanlage mit Klimaanlage	<b>6031.92D</b> <b>6035.92D</b>

# Thermoswitch

## FIAT

	Engine	Ltr.	Year	Restriction*	Thermoswitches
1.5		1.5	1996.04 - 1998.06	ohne Klimaanlage	6031.92D
			1996.04 - 1998.06	mit Klimaanlage	6035.92D
1.6 16V	178 B3.000	1.6	1996.04 - 1996.04 -	ohne Klimaanlage mit Klimaanlage	6031.92D 6035.92D
1.6 16V (178DX.D1A)	178 B3.000	1.6	1996.04 - 2001.02 1996.04 - 2001.02	ohne Klimaanlage mit Klimaanlage	6031.92D 6035.92D
1.6 16V (178DYC1A06)	182 B6.000	1.6	2001.02 - 2001.02 -	ohne Klimaanlage mit Klimaanlage	6031.92D 6035.92D
1.7 TD (178DX.H1A)	176 A3.000	1.7	1996.04 - 2001.03 1996.04 - 2001.03	ohne Klimaanlage mit Klimaanlage	6031.92D 6035.92D
1.9 D (178DYD1A07)	223 A6.000	1.9	2001.03 - 2001.03 -	ohne Klimaanlage mit Klimaanlage	6031.92D 6035.92D

## PANDA

650	141 A.000	0.7	1982.01 - 2004.07		6010.95D
750	141 B.000, 156 A4.000, 156 A4.048	0.8	1991.06 - 1997.12		6031.92D
800		0.8	1981.02 - 1985.12		6010.95D
900	100 GL3.000, 1170 A1.046, 146 A.000	0.9	1980.10 - 1994.06 1992.04 - 1996.12		6010.95D 6031.92D
950	A 112 B1.054	1.0	1982.09 - 1986.12		6010.95D
1000	141 C2.000, 156 A2.100, 156 A2.246, 156 A3.000, 156 A3.100	1.0	1985.01 - 1994.12		6031.92D
1000 i.e	156 A2.246	1.0	1992.08 - 2004.02		6031.92D
1000 i.e.	141 C2.000, 156 A2.246	1.0	1987.10 - 1998.08		6031.92D
1100	156 C.046, 176 B2.000, 187 A1.000	1.1	1991.05 - 2004.07		6031.92D

## PUNTO (176)

1.1	176 B2.000	1.1	1996.04 - 2000.02	ohne Klimaanlage	6031.92D
1.4 GT Turbo	176 A4.000, 176 B6.000	1.4	1994.01 - 1999.09		6010.92D
55 1.1	176 A6.000, 176 B2.000	1.1	1993.09 - 1999.09	ohne Klimaanlage	6031.92D
60 1.2	176 A7.000, 176 B1.000, 176 B4.000	1.2	1994.01 - 1999.09	ohne Klimaanlage	6031.92D
75 1.2	176 A8.000	1.2	1993.10 - 1999.09 1993.10 - 1999.09	ohne Klimaanlage mit Klimaanlage	6031.92D 6035.92D
85 16V 1.2	176 B9.000	1.2	1997.04 - 2000.06 1997.04 - 2000.06	ohne Klimaanlage mit Klimaanlage	6031.92D 6035.92D
90 1.6	176 A9.000	1.6	1994.01 - 1997.04		6010.92D

## REGATA

60 Diesel 1.7	138 B6.000, 149 B3.000	1.7	1983.09 - 1989.03		6017.85D
65 Diesel 1.9	149 A1.000	1.9	1984.04 - 1989.07		6017.85D
70 1.3	138 B2.000, 149 A3.000, 149 A7.000	1.3	1983.09 - 1989.07 1983.09 - 1986.07		6010.95D 6031.92D
75 1.5	138 B3.048, 138 C3.048	1.5	1983.12 - 1989.07		6010.95D
75 1.5 i.e.	138 C2.048, 149 C1.000	1.5	1985.07 - 1989.07 1986.12 - 1989.07		6010.95D 6031.92D
80 Turbo Diesel 1.9	831 D1.000	1.9	1986.05 - 1989.07		6017.85D
85 1.5	138 B3.000, 149 A5.000	1.5	1985.05 - 1987.12 1984.01 - 1989.04		6010.95D 6031.92D
85 1.6	149 A.000	1.6	1983.10 - 1990.06		6010.95D
85 Super 1.5	138 B3.000	1.5	1983.09 - 1985.04		6010.95D
90 i.e. 1.6	149 C2.000	1.6	1987.01 - 1989.07		6010.95D
100 1.6 (RF)	149 A4.000	1.6	1984.09 - 1986.12		6010.95D
100 i.e. 1.6	149 C3.000	1.6	1987.01 - 1990.12		6031.92D
100 Super 1.6	149 A2.000, 149 A4.000, 149 C3.000	1.6	1983.10 - 1990.12 1983.10 - 1989.07		6010.95D 6031.92D

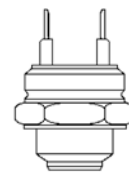

# FIAT

	Engine	Ltr.	Year	Restriction*	Thermaswitches
<b>RITMO I (138A)</b>					
55 Diesel 1.7	138 A5.000	1.7	1979.10 - 1982.09		6017.85D
60 1.0	127 A6.000	1.0	1978.09 - 1982.09		6010.88D
65 1.3	138 A1.000	1.3	1978.01 - 1982.09		6010.88D
75 1.3	138 A3.000	1.3	1981.01 - 1982.09		6010.95D
75 i.e. 1.5	138 C2.048, 149 C1.000	1.5	1985.10 - 1987.05		6010.92D
85 1.5	138 A4.000	1.5	1981.01 - 1982.09		6010.95D
105 Sport 1.6	138 AR.000	1.6	1981.05 - 1982.12		6010.95D
125 TC Abarth 2.0	138 AR1.000	2.0	1981.11 - 1982.09		6010.95D
<b>RITMO II (138A)</b>					
60 1.1	138 B.000, 138 B1.000, 138 C1.000, 146 A4.048	1.1	1985.04 - 1987.12 1982.10 - 1985.10		6010.92D 6031.92D
70 1.3	138 B2.000	1.3	1983.01 - 1985.04		6010.92D
75 1.5	138 C2.048, 149 C1.000	1.5	1985.09 - 1988.12		6010.92D
<b>RITMO Bertone Cabriolet</b>					
85 1.5	138 A4.000, 138 B3.000	1.5	1980.01 - 1989.07		6031.92D
100 1.6	138 AR.000, 138 AR.048	1.6	1985.10 - 1987.12		6031.92D
<b>SEICENTO (187)</b>					
0.9	1170 A1.046	0.9	1998.01 -		6031.97D
1.1	176 B2.000, 187 A1.000	1.1	1998.01 -		6031.97D
<b>SIENA</b>					
1.2	178 B5.000	1.2	1998.09 - 1998.09 -	ohne Klimaanlage mit Klimaanlage	6031.92D 6035.92D
1.4	178 B2.000, 178 B2.016	1.4	1996.04 - 1996.04 -	ohne Klimaanlage mit Klimaanlage	6031.92D 6035.92D
1.6 16V	178 B3.000	1.6	1998.09 - 1998.09 -	ohne Klimaanlage mit Klimaanlage	6031.92D 6035.92D
<b>STRADA (178E)</b>					
1.2	178 B5.000, 188 A4.000	1.2	1999.06 - 1999.06 -	ohne Klimaanlage mit Klimaanlage	6031.92D 6035.92D
1.7 TD	176 A3.000	1.7	1999.06 -	ohne Klimaanlage	6031.92D
1.9 D	223 A6.000	1.9	2000.12 -	ohne Klimaanlage	6031.92D
<b>TALENTO (290)</b>					
2.0	170 B	2.0	1992.05 - 1994.03		6031.92D
<b>TEMPRA (159)</b>					
1.4 i.e.	159 A2.000, 160 A1.046, 836 A4.000	1.4	1991.03 - 1996.08	Motornummer →8742134	6035.92D
1.6	159 A3.000	1.6	1990.03 - 1993.04		6035.92D
1.6 i.e.	159 A3.046, 159 A3.048, 159 B9.000, 835 C1.000	1.6	1990.06 - 1996.08		6035.92D
1.8	159 A4.000	1.8	1992.07 - 1993.06		6035.92D
1.8 i.e.	159 A4.046, 835 C2.000, 835 C4.000, 836 A5.000	1.8	1992.03 - 1993.12 1990.03 - 1996.08	ohne Klimaanlage mit Klimaanlage	6031.92D 6035.92D
1.9 D	149 A1.000, 160 A7.000	1.9	1991.07 - 1996.08		6017.85D
1.9 TD	160 A6.000, 160 B6.046, 160 D1.000	1.9	1990.05 - 1996.08		6017.85D
2.0 i.e.	159 A6.046	2.0	1990.10 - 1996.08		6035.92D
2.0 i.e.	159 A6.046	2.0	1991.01 - 1995.03		6035.92D

# Thermoswitch

## FIAT

### TIPO (160)

	Engine	Ltr.	Year	Restriction*	Thermoswitches
1.1	160 A3.000	1.1	1988.01 - 1991.10 1991.10 - 1991.10	ohne Klimaanlage mit Klimaanlage	<b>6031.92D</b> <b>6035.92D</b>
1.4	160 A1.000, 160 A1.048	1.4	1987.07 - 1989.12		<b>6035.92D</b>
1.4 i.e.	159 A2.000, 160 A1.046, 836 A4.000	1.4	1989.05 - 1995.04	mit Klimaanlage	<b>6035.92D</b>
1.6	160 A2.000	1.6	1991.10 - 1991.10	mit Klimaanlage	<b>6035.92D</b>
1.6 i.e.	149 C2.046, 159 A3.046, 159 A3.048, 835 C1.000	1.6	1988.02 - 1993.01 1991.10 - 1995.04	ohne Klimaanlage mit Klimaanlage	<b>6031.92D</b> <b>6035.92D</b>
1.6 SX DGT	159 A3.000	1.6	1989.05 - 1992.10	mit Klimaanlage	<b>6035.92D</b>
1.7 D	149 B4.000	1.7	1988.01 - 1995.10		<b>6017.85D</b>
1.8 i.e	836 A5.000	1.8	1993.03 - 1995.04		<b>6031.92D</b>
1.8 i.e.	159 A4.000, 159 A4.046, 835 C2.000, 835 C4.000	1.8	1990.10 - 1995.04 1990.10 - 1995.04	ohne Klimaanlage mit Klimaanlage	<b>6031.92D</b> <b>6035.92D</b>
1.8 i.e.16V Sport	160 A5.000	1.8	1989.11 - 1992.06		<b>6031.92D</b>
1.9 D	149 A1.000, 160 A7.000	1.9	1991.07 - 1996.08		<b>6017.85D</b>
1.9 TD (160.AW)	160 B6.046	1.9	1992.03 - 1993.06		<b>6017.85D</b>
1.9 TD (160.EL, 160.GL, 160.AQ, 160.EI, 160.AR)	160 A6.000, 160 A6.046, 160 D1.000	1.9	1990.09 - 1995.04		<b>6017.85D</b>
2.0 16V (160.AV)	160 A8.046	2.0	1991.07 - 1995.04		<b>6035.92D</b>
2.0 i.e. (160.AJ)	159 A5.046	2.0	1990.06 - 1992.03 1990.06 - 1992.03		<b>6031.92D</b> <b>6035.92D</b>
2.0 i.e. (160.AT, 160.AJ)	159 A6.046	2.0	1990.03 - 1995.04 1990.03 - 1995.04		<b>6031.92D</b> <b>6035.92D</b>
2.0 i.e. 16V Sport (160.EF)	836 A3.000	2.0	1993.03 - 1995.04	ohne Klimaanlage	<b>6035.92D</b>

### UNO (146A/E)

1.3 Super Diesel	127 A5.000, 146 B1.000	1.3	1983.06 - 1992.03		<b>6017.85D</b>
1.3 Turbo i.e.	146 A2.000, 146 A2.146, 146 A2.246	1.3	1985.04 - 1989.08 1989.09 - 1991.03		<b>6031.92D</b> <b>6033.88</b>
1.4 Turbo i.e.	146 A8.000, 146 A8.046	1.4	1989.12 - 1996.12 1989.09 - 1993.09		<b>6031.92D</b> <b>6033.88</b>
1.6	159 A3.046	1.6	1989.12 - 1993.12 1989.12 - 1993.12	ohne Klimaanlage mit Klimaanlage	<b>6031.92D</b> <b>6035.92D</b>
1.6 R		1.6	1992.12 - 1995.12 1992.12 - 1995.12	ohne Klimaanlage mit Klimaanlage	<b>6031.92D</b> <b>6035.92D</b>
1.9 D	149 B5.046	1.9	1989.09 - 1994.03		<b>6040.88</b>
45 0.9	146 A.000, 146 A.1000	0.9	1983.03 - 1992.09		<b>6010.95D</b>
45 1.0 (146A.ED)	156 A2.048, 156 A2.100	1.0	1986.06 - 1993.12		<b>6031.92D</b>
45 i.e. 1.0	156 A2.246	1.0	1984.04 - 1995.10		<b>6031.92D</b>
50 1.1	146 A4.044, 156 C.046	1.1	1986.01 - 1993.12 1990.01 - 1993.12	ohne Klimaanlage mit Klimaanlage	<b>6031.92D</b> <b>6035.92D</b>
50 i.e. 1.1	146 C3.000	1.1	1992.06 - 1993.12 1992.06 - 1993.12	ohne Klimaanlage mit Klimaanlage	<b>6031.92D</b> <b>6035.92D</b>
55 1.0		1.0	1994.04 - 2000.08		<b>6031.92D</b>
55 1.1	138 B.000	1.1	1983.01 - 1989.08		<b>6031.92D</b>
60 1.1	146 A4.048, 160 A3.000	1.1	1985.05 - 1992.12 1989.04 - 1992.12	mit Klimaanlage mit Klimaanlage	<b>6031.92D</b> <b>6035.92D</b>
60 Diesel 1.7	146 B2.000, 149 B3.000	1.7	1986.07 - 1989.08 1989.09 - 1993.12		<b>6017.85D</b> <b>6040.88</b>
70 1.3	138 B2.000, 149 A7.000	1.3	1983.01 - 1989.08		<b>6031.92D</b>
70 i.e. 1.4	146 C1.000, 160 A1.046	1.4	1989.09 - 1993.12 1989.09 - 1993.12	ohne Klimaanlage mit Klimaanlage	<b>6031.92D</b> <b>6035.92D</b>
70 S 1.4	160 A1.048	1.4	1989.09 - 1992.10 1989.09 - 1992.10	ohne Klimaanlage mit Klimaanlage	<b>6031.92D</b> <b>6035.92D</b>
70 TD 1.4	146 B.000, 146 B3.000	1.4	1986.10 - 1990.10		<b>6017.85D</b>
75 i.e. 1.5	138 C2.048, 149 C1.000	1.5	1985.10 - 1993.12 1985.10 - 1993.12	ohne Klimaanlage mit Klimaanlage	<b>6031.92D</b> <b>6035.92D</b>



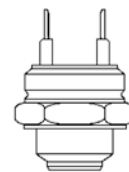

# FIAT

	Engine	Ltr.	Year	Restriction*	Thermaswitches
<b>X 1/9 (128 AS)</b>					
1.3	128 AS.000	1.3	1975.10 - 1978.06		<b>6010.92D</b>
1.3 Exclusiv Serie	128 AS.000	1.3	1973.05 - 1979.12		<b>6010.92D</b>
1.5 Five Speed	138 AS.000, 138 BS.031	1.5	1978.11 - 1989.12		<b>6010.92D</b>

# FORD

	Engine	Ltr.	Year	Restriction*	Thermaswitches
<b>ESCORT III / IV 1980 --&gt; 1990</b>					
1.1	GLB, GMA, GPA, GSE, GSG	1.1	1980.09 - 1990.07		6010.95D
1.3	JBB, JLA, JLB, JPA	1.3	1980.09 - 1990.07		6010.95D
1.4	F6B, F6D, FUA, FUC	1.4	1986.01 - 1990.07		6010.88D
1.6	LP1, LPA, LUA, LUG	1.6	1980.09 - 1990.07		6010.95D
1.6 i	L4B, LJB	1.6	1985.07 - 1990.07		6010.95D
<b>ESCORT V / VI / VII / Classic 1990 --&gt;</b>					
RS 2000	N7A	2.0	1995.02 - 1998.10		6010.95D
<b>GALAXY</b>					
1.9 TDI	1Z, AFN, AHU, ANU, ASZ, AUJ, AVG	1.9	1995.03 - 2006.05		6037.95D
2.8 V6	AYL	2.8	2000.04 - 2006.05		6037.95D
2.8 i V6	AAA, AMY	2.8	1995.11 - 2000.04		6037.95D
<b>SIERRA</b>					
1.6	LCS, LCT, LSD, LSE, LSF	1.6	1982.08 - 1993.02		6010.88D
1.6 i	L6B	1.6	1989.10 - 1993.02		6010.88D
1.8	R2A, R2C, R6A, REB, RED, REF	1.8	1984.10 - 1993.02		6010.88D
1.8 TD	RFA, RFB, RFL	1.8	1988.08 - 1993.02		6010.88D
2.0	N8C, N9C, NES, NET, NR2, NRB, NRD, NYT	2.0	1982.08 - 1993.02		6010.88D
2.0 16V Cosworth	N5C, N5D	2.0	1990.01 - 1993.02		6010.88D
2.0 i	N4A, N4B, N4I, N8A, N9B, N9C, NE5, NEJ, NR2, NRB	2.0	1985.03 - 1993.02		6010.88D
2.0 RS Cosworth	N5B	2.0	1987.11 - 1990.01		6010.88D
2.3	YYT	2.3	1982.08 - 1986.12		6010.88D
2.3 D	YTR, YTT	2.3	1982.08 - 1993.02		6010.88D
2.8	PRG	2.8	1987.01 - 1988.08		6010.88D
2.8 i XR	PRG	2.8	1987.01 - 1988.08		6010.88D
2.8 XR	PRT	2.8	1985.02 - 1986.12		6010.88D
2.8 XR4i	PR6, PRT	2.8	1982.08 - 1986.12		6010.88D
2.9	B4B, B4C	2.9	1988.08 - 1993.02		6010.88D
2.9 i	B4B, B4C	2.9	1988.08 - 1993.02		6010.88D
2.9 i XR	B4A, B4B, B4C	2.9	1988.08 - 1993.02		6010.88D

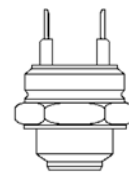

# INNOCENTI

	Engine	Ltr.	Year	Restriction*	Thermaswitches
<b>MINI</b>					
0.55	Daihatsu-EB	0.6	1987.01 - 1991.12		<b>6010.92D</b>
0.65		0.7	1984.01 - 1995.01		<b>6010.92D</b>
1.0	BLM C 99 H	1.0	1974.05 - 1991.10		<b>6010.92D</b>
1.3	BLM C 12 H	1.3	1976.08 - 1982.02		<b>6010.92D</b>
1.3 De Tomaso	BLM C 12 HH	1.3	1976.08 - 1982.02		<b>6010.92D</b>

# Thermoswitch

## JAGUAR

Engine

Ltr.

Year

Restriction\*

Thermaswitches

### XJ

12 5.3	V 12 (75-79)	5.3	1972.06 - 1989.09		<b>6010.92D</b>
12 H.E.	V 12 (82-90)	5.3	1981.09 - 1992.12		<b>6010.92D</b>
Sovereign V12	7P, V 12 (90-93, 197KW)	5.3	1985.07 - 1992.12		<b>6010.92D</b>

### XJS / XJSC

5.3	8C (88-92), 8S (92-93), V 12 (90-93, 197KW), V 12 (90-93, 211KW)	5.3	1975.09 - 1993.08		<b>6010.92D</b>
5.3 H.E.	8S (86-88), V 12 (82-90)	5.3	1981.07 - 1992.05		<b>6010.92D</b>

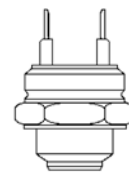

# LADA

	Engine	Ltr.	Year	Restriction*	Thermaswitches
<b>1200 / 1300 / 1500 / 1600</b>					
1200	BA3 2101	1.2	1970.01 - 1986.06		<b>6010.92D</b>
1300	BA3 21011, BA3 2105	1.3	1974.08 - 1987.01		<b>6010.92D</b>
1500	BA3 2103	1.4	1972.09 - 1986.10		<b>6010.92D</b>
1600	BA3 2106	1.6	1972.09 - 1986.10		<b>6010.92D</b>
<b>NIVA (2121)</b>					
1600	BA3 2121	1.6	1976.12 - 1995.03		<b>6010.92D</b>
1700 i	BA3 21214	1.7	1996.06 -		<b>6010.92D</b>
<b>NOVA</b>					
1300	BA3 2105	1.3	1985.09 - 1990.12		<b>6010.92D</b>
1500	BA3 2103, BA3 2103 (KAT)	1.4	1985.03 - 1993.02		<b>6010.92D</b>
1600	BA3 2106	1.6	1988.01 -		<b>6010.92D</b>
1700		1.7	1994.08 -		<b>6010.92D</b>
1700 i		1.7	1996.06 -		<b>6010.92D</b>
<b>SAMARA (2108, 2109)</b>					
1100	BA3 21081, BA3 21081 (KAT)	1.1	1988.02 - 1994.12		<b>6010.92D</b>
1300	BA3 2108, BA3 2108 (KAT), BA3 21115	1.3	1986.01 - 1994.12		<b>6010.92D</b>
1500	BA3 21083, BA3 21083 (KAT), BA3 2111	1.5	1988.01 -		<b>6010.92D</b>
<b>SAMARA FORMA</b>					
1100	BA3 21081 (KAT)	1.1	1991.07 -		<b>6010.92D</b>
1300	BA3 2108	1.3	1989.05 - 1997.07		<b>6010.92D</b>
1500	BA3 21083, BA3 21083 (KAT), BA3 2111	1.5	1991.07 -		<b>6010.92D</b>

# LANCIA

Engine

Ltr.

Year

Restriction\*

Thermoswitches

## BETA (828)

1300	828 D3.000	1.4	1981.12 - 1984.12		6010.88D
1600	828 B.000	1.6	1973.08 - 1984.12		6010.88D
2000	828 B1.000	2.0	1976.04 - 1986.10	828 B1.000	6010.88D
2000 i.e.	828 B4.000	2.0	1981.05 - 1984.12	828 B4.000	6010.88D
2000 Volumex		2.0	1983.07 - 1984.09		6010.88D
2000 VX		2.0	1983.07 - 1984.12		6010.88D

## DEDRA (835)

1.6	159 B9.000	1.6	1994.10 - 1999.07 1994.10 - 1999.07	ohne Klimaanlage mit Klimaanlage	6031.92D 6035.92D
1.6 16V	182 A4.000	1.6	1996.01 - 1999.07 1996.01 - 1999.07	ohne Klimaanlage mit Klimaanlage	6031.92D 6035.92D
1.6 i.e.	835 A1.000, 835 A1.046, 835 C1.000	1.6	1989.08 - 1999.07	ohne Klimaanlage	6031.92D
1.6 LE	159 B9.000	1.6	1994.07 - 1999.07 1994.07 - 1999.07	ohne Klimaanlage mit Klimaanlage	6031.92D 6035.92D
1.8 16V LE	182 A2.000	1.8	1996.03 - 1999.07 1996.03 - 1999.07	ohne Klimaanlage mit Klimaanlage	6031.92D 6035.92D
1.8 GT 16V	183 A1.000	1.8	1996.03 - 1999.07 1996.03 - 1999.07	ohne Klimaanlage mit Klimaanlage	6031.92D 6035.92D
1.8 i.e.	835 A2.000, 835 A2.046, 835 C5.000, 836 A5.000	1.8	1989.09 - 1999.07 1989.09 - 1999.07	ohne Klimaanlage Schaltgetriebe ohne Klimaanlage Automatikgetriebe	6031.92D 6035.92D
2.0 Integrale	836 A3.000	2.0	1994.07 - 1999.07 1994.07 - 1999.07	ohne Klimaanlage mit Klimaanlage	6031.92D 6035.92D
2.0 16V	836 A3.000	2.0	1994.07 - 1999.07 1994.07 - 1999.07	ohne Klimaanlage mit Klimaanlage	6031.92D 6035.92D
2.0 HF Integrale	835 A7.046	2.0	1990.11 - 1994.07 1990.11 - 1994.07	ohne Klimaanlage mit Klimaanlage	6031.92D 6035.92D
2.0 i.e.	835 A5.000, 835 A5.046	2.0	1989.09 - 1999.07 1989.09 - 1999.07	ohne Klimaanlage Schaltgetriebe ohne Klimaanlage Automatikgetriebe	6031.92D 6035.92D
2.0 i.e. Turbo	835 A8.046	2.0	1991.04 - 1999.07 1991.04 - 1999.07	ohne Klimaanlage mit Klimaanlage	6031.92D 6035.92D
2.0 i.e. Turbo Integrale	835 A7.000	2.0	1990.05 - 1994.07 1990.05 - 1994.07	ohne Klimaanlage mit Klimaanlage	6031.92D 6035.92D
2.0 Turbo	835 A8.000	2.0	1990.11 - 1994.06 1990.11 - 1994.06	ohne Klimaanlage mit Klimaanlage	6031.92D 6035.92D

## DELTA I (831AB0)

1.3	831 A2.000, 831 B.000	1.3	1979.09 - 1992.08		6010.88D
1.5	831 A1.000, 831 B1.000	1.5	1979.09 - 1992.12		6010.88D
1.6 GT i.e.	149 C2.000, 831 B7.000	1.6	1987.05 - 1992.08 1986.08 - 1988.08		6010.95D 6017.85D
1.6 HF Turbo	831 B3.000, 831 B7.046	1.6	1986.08 - 1993.05		6017.85D
1.9 Turbo DS	831 D1.000	1.9	1986.10 - 1989.12		6017.85D
2.0 16V HF Evo Integrale	831 E5.000, 831 E5.046	2.0	1993.06 - 1994.01		6017.85D
2.0 16V HF Integrale	831 D5.000	2.0	1989.03 - 1991.09		6017.85D
2.0 HF Integrale	831 B5.000, 831 C5.000, 831 C5.046	2.0	1986.11 - 1992.12		6017.85D

## DELTA II (836)

1.4 i.e. (836AF, 836AH)	160 A1.046, 836 A4.000	1.4	1994.10 - 1999.08		6035.92D
1.6 i.e. (836AD)	835 C1.000	1.6	1993.06 - 1999.08		6035.92D

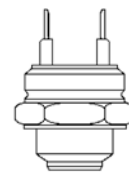

# LANCIA

	Engine	Ltr.	Year	Restriction*	Thermaswitches
1.6 i.e. (836AP)	182 A6.000	1.6	1996.03 - 1999.08 1996.03 - 1999.08	ohne Klimaanlage mit Klimaanlage	<b>6031.92D</b> <b>6035.92D</b>
1.6 i.e. 16V (836AO)	182 A4.000	1.6	1996.01 - 1999.08 1996.01 - 1999.08	ohne Klimaanlage mit Klimaanlage	<b>6031.92D</b> <b>6035.92D</b>
1.8 i.e. (836AE)	835 C2.000	1.8	1993.06 - 1999.08 1993.06 - 1999.08	ohne Klimaanlage mit Klimaanlage	<b>6031.92D</b> <b>6035.92D</b>
1.8 i.e. (836AG, 836AL)	835 C4.000, 836 A6.000, 836 C4.000	1.8	1994.07 - 1999.08 1994.07 - 1999.08	ohne Klimaanlage mit Klimaanlage	<b>6031.92D</b> <b>6035.92D</b>
1.8 i.e. 16V (836AQ)	182 A2.000	1.8	1996.03 - 1999.08 1996.03 - 1999.08	ohne Klimaanlage mit Klimaanlage	<b>6031.92D</b> <b>6035.92D</b>
1.8 i.e. 16V GT (836AR)	183 A1.000	1.8	1996.03 - 1999.08 1996.03 - 1999.08	ohne Klimaanlage mit Klimaanlage	<b>6031.92D</b> <b>6035.92D</b>
2.0 16V (836AA, 836CA)	836 A3.000	2.0	1993.06 - 1999.08 1993.06 - 1999.08	ohne Klimaanlage mit Klimaanlage	<b>6031.92D</b> <b>6035.92D</b>
2.0 16V Turbo (836AB)	836 A2.000	2.0	1993.06 - 1999.08 1993.06 - 1995.12	ohne Klimaanlage mit Klimaanlage	<b>6031.92D</b> <b>6035.92D</b>
2.0 16V Turbo (836AS)	175 A4.000	2.0	1996.07 - 1999.08	ohne Klimaanlage	<b>6031.92D</b>
<b>FULVIA</b>					
1.3		1.3	1968.09 - 1975.07		<b>6010.88D</b>
<b>PRISMA (831AB0)</b>					
1.3	831 A2.000	1.3	1983.01 - 1992.02		<b>6010.88D</b>
1.5	138 C2.048, 831 A1.000, 831 B1.000, 831 B1.048	1.5	1983.01 - 1992.02		<b>6010.88D</b>
1.6	831 B6.000	1.6	1986.08 - 1992.02		<b>6010.88D</b>
1.6 i.e.	831 B7.000	1.6	1986.05 - 1989.12		<b>6010.88D</b>
1.6 i.e. Super	149 C2.000	1.6	1987.05 - 1989.12		<b>6010.88D</b>
<b>THEMA (834)</b>					
2000 16V (834FA)	834 F1.000	2.0	1992.05 - 1994.07		<b>6010.88D</b>
2000 16V Turbo (834AC)	834 C1.000	2.0	1988.12 - 1990.06		<b>6010.88D</b>
2000 16V Turbo (834GC, 834FC)	834 F2.000	2.0	1992.10 - 1994.07		<b>6010.88D</b>
2000 i.e.	834 B.048	2.0	1986.03 - 1988.09		<b>6010.88D</b>
2000 i.e. (834B)	834 B.000	2.0	1984.11 - 1988.09		<b>6010.88D</b>
2000 i.e. (834BV)	834 B.146	2.0	1987.09 - 1992.05		<b>6010.88D</b>
2000 i.e. 16V (834AI)	834 B2.246	2.0	1989.02 - 1992.05		<b>6010.88D</b>
2000 i.e. 16V Turbo (834AL)	834 C1.246	2.0	1989.04 - 1993.03		<b>6010.88D</b>
2000 i.e. Turbo (834C)	834 C.000	2.0	1984.11 - 1987.12		<b>6010.88D</b>
2000 i.e. Turbo (834CV)	834 C.146	2.0	1986.07 - 1990.05		<b>6010.88D</b>
2000 Turbo	834 C.146	2.0	1989.01 - 1992.03		<b>6010.88D</b>
2000 Turbo 16V (834GC, 834FC)	834 F2.000	2.0	1992.11 - 1994.07		<b>6010.88D</b>
2500 Turbo D (834D)	8144.91	2.4	1984.11 - 1988.09		<b>6010.85D</b>
2500 Turbo DS (834AE)	8144.97	2.5	1988.06 - 1992.05		<b>6010.85D</b>
2500 Turbo DS (834AM)	8144.97S	2.5	1988.05 - 1992.07		<b>6010.85D</b>
2500 Turbo DS (834D)	8144.91	2.4	1987.03 - 1990.09		<b>6010.85D</b>
2500 Turbo DS (834FE, 834LE)	8144.97 Y	2.5	1992.05 - 1994.07		<b>6010.85D</b>
2850 V6 i.e. (834AD, 834CD, 834BD)	834 E.146	2.8	1988.06 - 1992.05		<b>6017.85D</b>
2850 V6 i.e. (834F)	834 E.000	2.8	1984.11 - 1988.09		<b>6017.85D</b>
<b>TREVI (828DB)</b>					
2000 i.e.	828 B4.000	2.0	1980.05 - 1987.01		<b>6010.88D</b>
2000 Volumex (828DB17)	828 B7.000	2.0	1983.08 - 1985.05		<b>6010.88D</b>
<b>Y10 (156)</b>					
1.0 Fire	156 A 2.000, 156 A 2.100, 156 A.000, 156 A2.246	1.0	1985.03 - 1992.02		<b>6031.92D</b>
1.0 Turbo	156 A 1.000	1.0	1985.03 - 1989.02		<b>6031.92D</b>

# Thermoswitch

## LANCIA

	Engine	Ltr.	Year	Restriction*	Thermoswitches
1.1 Avenue	176 B2.000	1.1	1995.01 - 1995.12 1995.01 - 1995.12	ohne Klimaanlage mit Klimaanlage	<b>6031.92D</b> <b>6035.92D</b>
1.1 i.e	156 C.000	1.1	1989.08 - 1992.06		<b>6031.92D</b>
1.1 i.e. Fire	156 C.046	1.1	1989.07 - 1995.12 1989.07 - 1995.12	ohne Klimaanlage mit Klimaanlage	<b>6031.92D</b> <b>6035.92D</b>
1.3 i.e. Fire	146 A 5.046, 156 B.000	1.3	1987.11 - 1991.12		<b>6031.92D</b>



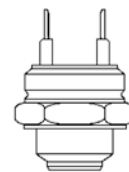

# OPEL

	Engine	Ltr.	Year	Restriction*	Thermaswitches
<b>ASCONA C</b>					
1.3 N	13 N	1.3	1981.09 - 1986.08		<b>6010.95D</b>
1.3 S	13 S	1.3	1981.09 - 1988.08		<b>6010.95D</b>
1.6	16 N, 16 SV	1.6	1981.09 - 1988.08		<b>6010.95D</b>
1.6 i	C 16 LZ, C 16 NZ, E 16 NZ	1.6	1986.09 - 1988.08		<b>6010.95D</b>
1.6 S	16 SH	1.6	1981.09 - 1986.08		<b>6010.95D</b>
1.8	E 18 NV	1.8	1987.09 - 1988.08		<b>6010.95D</b>
1.8 E	C 18 NE, S 18 NV	1.8	1985.01 - 1986.08		<b>6010.95D</b>
1.8 i	18 E	1.8	1982.09 - 1986.08		<b>6010.95D</b>
2.0 i	20 NE, C 20 NE, C 20 NEF	2.0	1986.09 - 1988.08		<b>6010.95D</b>
2.0 i GT	20 SEH	2.0	1987.03 - 1988.08		<b>6010.95D</b>
<b>ASTRA F</b>					
1.4	14 SE	1.4	1992.09 - 1998.01	mit Klimaanlage	<b>6031.100D</b>
			1992.09 - 1998.01	mit Klimaanlage	<b>6031.88D</b>
1.4 i	C 14 NZ	1.4	1991.09 - 1999.01	mit Klimaanlage	<b>6031.100D</b>
			1991.09 - 1999.01	mit Klimaanlage	<b>6031.88D</b>
1.4 i 16V	X 14 XE	1.4	1996.01 - 2001.03	mit Klimaanlage	<b>6031.100D</b>
			1996.01 - 2001.03	mit Klimaanlage	<b>6031.88D</b>
1.4 Si	C 14 SE	1.4	1992.03 - 2001.03	mit Klimaanlage	<b>6031.100D</b>
			1992.03 - 2001.03	mit Klimaanlage	<b>6031.88D</b>
1.6	16 LZ2, 16 NZR	1.6	1995.09 - 1998.01	mit Klimaanlage	<b>6031.100D</b>
			1995.09 - 1998.01	mit Klimaanlage	<b>6031.88D</b>
1.6 i	C 16 NZ, X 16 SZ, X 16 SZR	1.6	1991.09 - 2001.03	mit Klimaanlage	<b>6031.100D</b>
			1991.09 - 2001.03	mit Klimaanlage	<b>6031.88D</b>
1.6 i 16V	X 16 XEL	1.6	1994.08 - 1998.09	mit Klimaanlage	<b>6031.100D</b>
			1994.08 - 1998.09	mit Klimaanlage	<b>6031.88D</b>
1.6 Si	C 16 SE	1.6	1992.03 - 1994.12	mit Klimaanlage	<b>6031.100D</b>
			1992.03 - 1994.12	mit Klimaanlage	<b>6031.88D</b>
1.8 i	C 18 NZ	1.8	1991.09 - 1998.09	mit Klimaanlage	<b>6031.100D</b>
			1991.09 - 1998.09	mit Klimaanlage	<b>6031.88D</b>
1.8 i 16V	C 18 XE, C 18 XEL, X 18 XE	1.8	1993.06 - 2001.03	mit Klimaanlage	<b>6031.100D</b>
			1993.06 - 2001.03	mit Klimaanlage	<b>6031.88D</b>
2.0 GSI 16V	C 20 XE	2.0	1991.09 - 1998.01	mit Klimaanlage	<b>6031.100D</b>
			1991.09 - 1998.01	mit Klimaanlage	<b>6031.88D</b>
2.0 i	C 20 NE	2.0	1991.09 - 1998.09	mit Klimaanlage	<b>6031.100D</b>
			1991.09 - 1998.09	mit Klimaanlage	<b>6031.88D</b>
2.0 i 16V	C 20 XE, X 20 XEV	2.0	1993.03 - 1998.09	mit Klimaanlage	<b>6031.100D</b>
			1993.03 - 1998.09	mit Klimaanlage	<b>6031.88D</b>
<b>CALIBRA A</b>					
2.0 i	C 20 NE	2.0	1990.06 - 1997.07	mit Klimaanlage	<b>6031.100D</b>
			1990.06 - 1997.07	mit Klimaanlage	<b>6031.88D</b>
2.0 i 16V	C 20 XE, X 20 XEV	2.0	1990.06 - 1994.02	mit Klimaanlage	<b>6031.100D</b>
			1990.06 - 1997.07	mit Klimaanlage	<b>6031.88D</b>
2.0 i Turbo	C 20 LET	2.0	1992.03 - 1997.07	mit Klimaanlage	<b>6031.100D</b>
<b>COMBO</b>					
1.2	C 12 NZ, X 12 SZ	1.2	1994.07 - 2001.10		<b>6031.100D</b>
1.4	C 14 NZ, C 14 SE, X 14 SZ	1.4	1994.07 - 2001.10		<b>6031.100D</b>
1.4 16V	X 14 XE	1.4	1999.08 - 2001.10		<b>6031.100D</b>
<b>CORSA A</b>					
1.0	10 S	1.0	1982.09 - 1993.03	Chassis No →J4999999	<b>6010.95D</b>
			1982.09 - 1993.03	Chassis No K4000001→	<b>6031.100D</b>

# OPEL

	Engine	Ltr.	Year	Restriction*	Thermaswitches
1.2	12 NC, 12 ST, E 12 GV	1.2	1982.09 - 1990.08	Chassis No →J4999999	<b>6010.95D</b>
			1982.09 - 1990.08	Chassis No K4000001→	<b>6031.100D</b>
1.2 i	C 12 NZ	1.2	1989.09 - 1993.03	Chassis No →J4999999	<b>6010.95D</b>
			1989.09 - 1993.03	Chassis No K4000001→	<b>6031.100D</b>
1.2 N	12 NC, 12 NV, E 12 GV	1.2	1985.01 - 1993.03	Chassis No →J4999999	<b>6010.95D</b>
			1985.01 - 1993.03	Chassis No K4000001→	<b>6031.100D</b>
1.2 S	12 S, 12 ST	1.2	1982.09 - 1993.03	Chassis No →J4999999	<b>6010.95D</b>
			1982.09 - 1993.03	Chassis No K4000001→	<b>6031.100D</b>
1.3	13 NB, 13 SB, C 13 N	1.3	1985.09 - 1989.10	Chassis No →J4999999	<b>6010.95D</b>
			1985.09 - 1989.10	Chassis No K4000001→	<b>6031.100D</b>
1.3 i	C 13 N	1.3	1986.09 - 1990.09	Chassis No →J4999999	<b>6010.95D</b>
			1986.09 - 1990.09	Chassis No K4000001→	<b>6031.100D</b>
1.3 S	13 SB	1.3	1982.09 - 1989.10	Chassis No →J4999999	<b>6010.95D</b>
			1982.09 - 1989.10	Chassis No K4000001→	<b>6031.100D</b>
1.4 i	C 14 NZ	1.4	1985.01 - 1993.03	Chassis No →J4999999	<b>6010.95D</b>
			1985.01 - 1993.03	Chassis No K4000001→	<b>6031.100D</b>
1.4 S	14 NV	1.4	1989.09 - 1993.03	Chassis No →J4999999	<b>6010.95D</b>
			1989.09 - 1993.03	Chassis No K4000001→	<b>6031.100D</b>
1.4 Si	C 14 SE	1.4	1991.09 - 1993.03	Chassis No →J4999999	<b>6010.95D</b>
			1991.09 - 1993.03	Chassis No K4000001→	<b>6031.100D</b>
1.6 GSI	C 16 NZ, C 16 SE, C 16 SEI, E 16 SE	1.6	1988.05 - 1993.03	Chassis No →J4999999	<b>6010.95D</b>
			1988.05 - 1993.03	Chassis No K4000001→	<b>6031.100D</b>
<b>CORSA B</b>					
1.0 i 12V	X 10 XE	1.0	1996.11 - 2000.09		<b>6031.100D</b>
1.2 i	12 NZ, C 12 NZ, X 12 SZ	1.2	1993.03 - 2000.09		<b>6031.100D</b>
1.2 i 16V	X 12 XE	1.2	1998.03 - 2000.09		<b>6031.100D</b>
1.4	C 14 SE	1.4	1993.04 - 1994.08		<b>6031.100D</b>
1.4 i	C 14 NZ, X 14 SZ	1.4	1993.03 - 2000.09		<b>6031.100D</b>
1.4 i 16V	C 14 SEL, X 14 XE	1.4	1994.09 - 2000.09		<b>6031.100D</b>
1.4 Si	C 14 SE	1.4	1993.03 - 2000.09		<b>6031.100D</b>
1.6 GSI 16V	C 16 XE	1.6	1993.03 - 2000.09		<b>6031.100D</b>
1.6 i 16V	C 16 SEL, X 16 XE	1.6	1994.09 - 2000.09		<b>6031.100D</b>
<b>KADETT D</b>					
1.0	10 N, 10 S	1.0	1979.09 - 1984.08		<b>6010.100D</b>
1.2	12 N, 12 ST	1.2	1979.08 - 1984.08		<b>6010.100D</b>

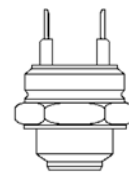

# OPEL

	Engine	Ltr.	Year	Restriction*	Thermaswitches
1.2 S	12 S	1.2	1979.08 - 1984.08		<b>6010.100D</b>
1.3 N	13 N, C 13 N	1.3	1979.08 - 1984.08		<b>6010.100D</b>
1.3 S	13 S	1.3	1979.08 - 1984.08		<b>6010.100D</b>
1.6		1.6	1979.09 - 1984.08		<b>6010.100D</b>
1.6 D	16 D	1.6	1982.03 - 1984.08		<b>6010.100D</b>
1.6 S	16 SH	1.6	1981.09 - 1984.08		<b>6010.100D</b>
1.8 GT/E	18 E	1.8	1983.02 - 1984.08		<b>6010.95D</b>
<b>KADETT E</b>					
1.2	12 SC	1.2	1984.09 - 1986.07	Chassis No →J2791967 →J5273427	<b>6010.95D</b>
			1984.09 - 1986.07	Chassis No J2791968→ J5273428→	<b>6031.100D</b>
1.3 i	C 13 N	1.3	1985.09 - 1991.08	Chassis No →J2791967 →J5273427	<b>6010.95D</b>
			1985.09 - 1991.08	Chassis No J2791968→ J5273428→	<b>6031.100D</b>
1.3 N	13 N, 13 NB	1.3	1984.09 - 1991.08	Chassis No →J2791967 →J5273427	<b>6010.95D</b>
			1984.09 - 1991.08	Chassis No J2791968→ J5273428→	<b>6031.100D</b>
1.3 S	13 S	1.3	1984.09 - 1993.02	Chassis No →J2791967 →J5273427	<b>6010.95D</b>
			1984.09 - 1993.02	Chassis No J2791968→ J5273428→	<b>6031.100D</b>
1.4 i	C 14 NZ	1.4	1990.01 - 1994.07		<b>6031.100D</b>
1.4 S	14 NV	1.4	1989.07 - 1993.02		<b>6031.100D</b>
1.6	16 SV	1.6	1986.09 - 1991.12	Chassis No →J2791967 →J5273427	<b>6010.95D</b>
			1986.09 - 1991.12	Chassis No J2791968→ J5273428→	<b>6031.100D</b>
1.6 D	16 D, 16 DA	1.6	1984.08 - 1989.12	Chassis No →JE222258 →J2791967	<b>6010.95D</b>
1.6 i	16 SV, C 16 LZ, C 16 NZ, E 16 NZ	1.6	1986.09 - 1993.02	Chassis No →J2791967 →J5273427	<b>6010.95D</b>
			1986.09 - 1994.07	Chassis No J2791968→ J5273428→	<b>6031.100D</b>
1.6 S	16 SH, 16 SV	1.6	1984.09 - 1991.08	Chassis No →J2791967 →J5273427	<b>6010.95D</b>
			1986.09 - 1991.08	Chassis No J2791968→ J5273428→	<b>6031.100D</b>

# Thermoswitch

## OPEL

	Engine	Ltr.	Year	Restriction*	Thermaswitches
1.8	18 E	1.8	1987.09 - 1990.08	Chassis No →J2791967 →J5273427	<b>6010.95D</b>
			1987.09 - 1990.08	Chassis No J2791968→ J5273428→	<b>6031.100D</b>
1.8 E	C 18 NE	1.8	1985.10 - 1986.08		<b>6010.95D</b>
1.8 GSI	18 E	1.8	1984.09 - 1986.08		<b>6010.95D</b>
1.8 i	18 E, C 18 NE	1.8	1984.09 - 1986.08	Chassis No →J2791967 →J5273427	<b>6010.95D</b>
			1984.09 - 1986.08	Chassis No J2791968→ J5273428→	<b>6031.100D</b>
1.8 S	E 18 NV, S 18 NV	1.8	1987.09 - 1991.08	Chassis No →J2791967 →J5273427	<b>6010.95D</b>
			1987.09 - 1991.08	Chassis No J2791968→ J5273428→	<b>6031.100D</b>
<b>OMEGA A</b>					
1.8	18 SEH, E 18 NVR	1.8	1986.09 - 1994.03	Chassis No →P1132203	<b>6010.95D</b>
			1986.09 - 1994.03	Chassis No P1132204→	<b>6031.105D</b>
1.8 N	18 NV	1.8	1986.09 - 1987.08		<b>6010.95D</b>
1.8 S	18 SV	1.8	1986.09 - 1994.03	Chassis No →P1132203	<b>6010.95D</b>
			1986.09 - 1994.03	Chassis No P1132204→	<b>6031.105D</b>
2.0	20 SE, C 20 NEF, C 20 NEJ	2.0	1986.09 - 1994.03	Chassis No →P1132203	<b>6010.95D</b>
			1986.09 - 1994.03	Chassis No P1132204→	<b>6031.105D</b>
2.0 i	C 20 NE, C 20 NEJ	2.0	1986.09 - 1994.03	Chassis No →P1132203	<b>6010.95D</b>
			1986.09 - 1994.03	Chassis No P1132204→	<b>6031.105D</b>
2.3 D	23 YD	2.3	1986.09 - 1994.03	Chassis No →K1000098	<b>6010.95D</b>
			1986.09 - 1994.03	Chassis No K1000099→	<b>6031.105D</b>
2.3 TD	23 YDT	2.3	1986.09 - 1988.08	Chassis No →K1000098	<b>6010.95D</b>
			1986.09 - 1988.08	Chassis No K1000099→	<b>6031.105D</b>
2.3 TD Interc.	23 DTR	2.3	1988.08 - 1994.03	Chassis No →K1000098	<b>6010.95D</b>
			1988.08 - 1994.03	Chassis No K1000099→	<b>6031.105D</b>
2.4 i	C 24 NE	2.4	1988.09 - 1994.03	Chassis No →P1132203	<b>6010.95D</b>
			1988.09 - 1994.03	Chassis No P1132204→	<b>6031.105D</b>
2.6 i	C 26 NE	2.6	1990.09 - 1994.03	Chassis No →P1132203	<b>6010.95D</b>
			1990.09 - 1994.03	Chassis No P1132204→	<b>6031.105D</b>

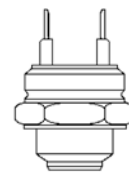

# OPEL

	Engine	Ltr.	Year	Restriction*	Thermaswitches
3.0 (3000)	C 30 LE	3.0	1987.03 - 1987.12		<b>6010.95D</b>
3.0 24V	C 30 SEJ	3.0	1989.09 - 1994.03	Chassis No →P1132203	<b>6010.95D</b>
			1989.09 - 1994.03	Chassis No P1132204→	<b>6031.105D</b>
3.0 24V (3000)	C 30 SE	3.0	1989.09 - 1994.03	Chassis No →P1132203	<b>6010.95D</b>
			1989.09 - 1994.03	Chassis No P1132204→	<b>6031.105D</b>
<b>OMEGA B</b>					
2.0	20 SE, X 20 SE	2.0	1994.03 - 2000.12	mit Klimaanlage	<b>6031.100D</b>
2.0 16V	X 20 XEV	2.0	1994.03 - 1999.09	mit Klimaanlage	<b>6031.100D</b>
2.2 16V	Y 22 XE, Z 22 XE	2.2	1999.09 - 2003.07	mit Klimaanlage	<b>6031.100D</b>
2.5 V6	X 25 XE	2.5	1994.03 - 2000.09	ohne Klimaanlage Chassis No R1000001→ →T1003097	<b>6031.100D</b>
			1994.03 - 2000.09	ohne Klimaanlage Chassis No T1003098→	<b>6031.105D</b>
3.0 V6	X 30 XE	3.0	1994.04 - 2001.02	ohne Klimaanlage Chassis No R1000001→ →T1003097	<b>6031.100D</b>
			1994.04 - 2001.02	ohne Klimaanlage Chassis No T1003098→	<b>6031.105D</b>
<b>SENATOR</b>					
2.5 i	25 NE	2.5	1990.09 - 1993.09	Chassis No →0053435	<b>6010.95D</b>
			1990.09 - 1993.09	Chassis No 0053436→	<b>6031.105D</b>
3.0	30 NE	3.0	1988.01 - 1990.09	Chassis No →0109241	<b>6010.95D</b>
			1988.01 - 1990.09	Chassis No 0109242→	<b>6031.105D</b>
3.0 i	C 30 NE	3.0	1988.01 - 1993.09	Chassis No →0011334	<b>6010.95D</b>
			1988.01 - 1993.09	Chassis No 0011335→	<b>6031.105D</b>
<b>SINTRA</b>					
2.2 DTI	X 22 DTH	2.2	1997.07 - 1999.04		<b>6031.105D</b>
2.2 i 16V	X 22 XE	2.2	1996.11 - 1999.04		<b>6031.105D</b>
3.0 i 24V	X 30 XE	3.0	1996.11 - 1999.04		<b>6031.105D</b>
<b>TIGRA</b>					
1.4 16V	X 14 XE	1.4	1994.07 - 2000.12		<b>6031.100D</b>
1.6 16V	C 16 SEL, X 16 XE	1.6	1994.07 - 1998.08		<b>6031.100D</b>
<b>VECTRA A</b>					
1.4 S	14 NV	1.4	1988.04 - 1992.06	Chassis No →KV999999 →K5999999 →L1000123	<b>6031.100D</b>

# Thermoswitch

## OPEL

	Engine	Ltr.	Year	Restriction*	Thermaswitches
1.6	16 SV	1.6	1988.09 - 1993.05	Chassis No →KV999999 →K5999999 →L1000123	<b>6031.100D</b>
1.6 i	C 16 NZ, C 16 NZ2, E 16 NZ	1.6	1988.09 - 1995.11	C16 NZ, E 16 NZ Chassis No →KV999999 →K5999999 →L1000123	<b>6031.100D</b>
1.6 S	16 SV	1.6	1988.09 - 1993.05	Chassis No →KV999999 →K5999999 →L1000123	<b>6031.100D</b>
1.8 i	18 SV	1.8	1988.09 - 1990.10	Chassis No →KV999999 →K5999999 →L1000123	<b>6031.100D</b>
1.8 S	18 SV, E 18 NVR	1.8	1988.09 - 1990.10	Chassis No →KV999999 →K5999999 →L1000123	<b>6031.100D</b>
2.0	C 20 NEF	2.0	1988.04 - 1989.09	Chassis No →KV999999 →K5999999 →L1000123	<b>6031.100D</b>
2.0 i	20 NE, 20 SEH, C 20 NE	2.0	1988.09 - 1995.11	Chassis No →KV999999 →K5999999 →L1000123	<b>6031.100D</b>
2.0 i GT	20 SEH	2.0	1988.09 - 1995.11	Chassis No →KV999999 →K5999999 →L1000123	<b>6031.100D</b>
<b>VECTRA B</b>					
1.6 i	16 LZ2, X 16 SZR	1.6	1995.10 - 2003.07	ohne Klimaanlage	<b>6031.100D</b>
1.6 i 16V	X 16 XEL, Y 16 XE, Z 16 XE	1.6	1995.10 - 2002.07	ohne Klimaanlage	<b>6031.100D</b>

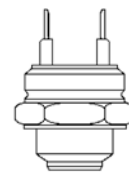

# PEUGEOT

	Engine	Ltr.	Year	Restriction*	Thermaswitches
<b>104</b>					
0.9	108 (XV3), 108 (XV5)	0.9	1972.10 - 1983.10		6010.88D
1.0	108C (XV8)	1.0	1983.09 - 1988.06		6010.88D
1.1	109 (XW3)	1.1	1976.07 - 1982.08		6010.88D
<b>205 I</b>					
1.0	108C (XV8)	1.0	1983.02 - 1987.10		6010.88D
1.1	109F (XW7), 109N (XW7)	1.1	1983.02 - 1987.10		6010.88D
1.4	150B (XY8), 150D (XY7), 150G (XY7), 150H (XY8)	1.4	1983.02 - 1987.10		6010.88D
<b>205 II</b>					
1.1	H1B (TU1)	1.1	1987.10 - 1990.10		6010.88D
1.4		1.4	1987.06 - 1989.12		6010.92D
1.6		1.6	1987.10 - 1998.09		6010.92D
1.6 GTI		1.6	1987.10 - 1989.12		6010.92D
<b>305</b>					
1.3	118 (XL5), XL5	1.3	1977.11 - 1982.09 1977.11 - 1986.08		6010.88D 6010.92D
1.5	117 (XR5S), 142 (XR5), 142 (XR5A)	1.5	1979.11 - 1982.09 1982.10 - 1990.07		6010.88D 6010.92D
1.6	171 (XU5S), B1A (XU51C), BAZ (XU5CP)	1.6	1982.10 - 1988.12 1982.10 - 1988.06		6010.88D 6010.92D
<b>309</b>					
1.1	E1, HDZ (TU1M)	1.1	1990.08 - 1993.12 1985.10 - 1989.07		6010.88D 6010.95D
1.3	G1A	1.3	1985.10 - 1989.07		6010.95D
1.4	K1D (TU3A), KDY (TU3M), KDZ (TU3M)	1.4	1989.03 - 1993.12		6010.88D
1.6	180Z (XU5J), B1A (XU51C), B2A (XU52C/K), B6B (XU5J)	1.6	1989.07 - 1993.12 1985.10 - 1989.07		6010.92D 6010.95D
1.9	D2B (XU9S), DDZ (XU9M), DFZ (XU9J1)	1.9	1985.10 - 1989.07		6010.95D
1.9 D	162 (XUD9), D9A (XUD9)	1.9	1986.06 - 1989.07		6010.95D
1.9 GTI	D6B (XU9JA (G-KAT)), DKZ (XU9JAZ)	1.9	1986.10 - 1989.07		6010.95D
<b>405 I</b>					
1.9 Sport MI-16	D6C (XU9J4), DFW (XU9J4Z)	1.9	1987.07 - 1992.12		6010.92D
<b>504</b>					
1.6	XC7P	1.6	1980.01 - 1987.06		6010.82D
1.8	XM, XM7	1.8	1968.07 - 1989.12		6010.82D
1.8 Injection	KF5, KF6	1.8	1968.07 - 1971.02		6010.82D
2.0	106 (XN1), 107 (XN2), XN1	2.0	1971.04 - 1986.07 1971.03 - 1986.06 1971.03 - 1986.06		6010.82D 6010.88D 6010.92D
2.0 TI	107 (XN2)	2.0	1971.01 - 1983.06		6010.88D
<b>505</b>					
1.8	105 (XM7), 105C (XM7A)	1.8	1981.06 - 1985.10 1985.09 - 1986.10		6010.88D 6010.92D
2.0	106 (XN1), 106E (XN1A)	2.0	1980.11 - 1991.09		6010.88D
2.0 TI,STI	829 (ZEJ)	2.0	1979.08 - 1986.10		6010.95D
2.2	851X (ZDJL)	2.2	1986.03 - 1993.12		6010.95D

# Thermoswitch

## PEUGEOT

Engine

Ltr.

Year

Restriction\*

Thermaswitches

2.2 GTI

851B (ZDJL)

2.2

1985.09 - 1986.12  
1983.08 - 1993.12

**6010.88D**

**6010.92D**

2.3 Turbo Diesel

147 (XD2S)

2.3

1980.09 - 1986.06

**6010.88D**

### BOXER (230)

2.0 i

RFW (XU10J2)

2.0

1994.03 - 2002.04  
1994.03 - 2002.04

ohne Klimaanlage  
mit Klimaanlage

**6031.92D**

**6035.92D**

2.8 HDI

8140.43S (F28DTCR)

2.8

2000.11 - 2002.04

mit Klimaanlage

**6035.92D**



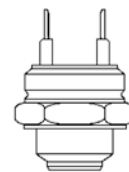

# PORSCHE

	Engine	Ltr.	Year	Restriction*	Thermaswitches
<b>924</b>					
2.0	XJ, XK	2.0	1975.11 - 1989.08		<b>6010.92D</b>
2.0 Carrera GT	M 31.50	2.0	1980.06 - 1986.10		<b>6010.92D</b>
2.0 Turbo	M 31.01, M 31.03	2.0	1978.11 - 1986.10		<b>6010.92D</b>
2.5 S	M 44.01, M 44.03	2.5	1981.10 - 1984.12		<b>6010.92D</b>
<b>928</b>					
4.6 S	M 28.11, M 28.12, M 28.21, M 28.22	4.6	1979.09 - 1983.07 1983.08 - 1986.07		<b>6010.85D</b> <b>6010.92D</b>
<b>944</b>					
2.5	M 44.01, M 44.02, M 44.03, M 44.04, M 44.05, M 44.06, M 44.07, M 44.08, M 44.09, M 44.10	2.5	1981.06 - 1990.12		<b>6010.92D</b>
2.5 S	M 44.40	2.5	1986.08 - 1988.07		<b>6010.92D</b>
2.5 Turbo	M 44.50, M 44.51, M 44.52	2.5	1985.08 - 1991.07		<b>6017.95D</b>

# RENAULT

Engine

Ltr.

Year

Restriction\*

Thermaswitches

## 4

0.8	800, 800 01, 800 705, B1B 707	0.8	1962.10 - 1989.07		6010.92D
1.1	688 711, 688 712, C1E 714, C1E 718, C1E 719	1.1	1976.10 - 1990.06 1982.07 - 1989.05		6010.92D 6010.95D

## 6

0.8	800.02	0.8	1969.10 - 1980.04		6010.92D
1.1	688.10	1.1	1970.08 - 1987.04		6010.92D

## 12

1.3	810-02/97	1.3	1969.10 - 1980.08		6010.92D
1.3 TS	810-06, 810.05	1.3	1972.08 - 1980.08		6010.92D

## 14

1.2	129	1.2	1976.05 - 1983.12		6010.92D
1.4	150, X5J	1.4	1979.09 - 1983.12		6010.92D

## 16

1.5		1.5	1965.09 - 1975.10		6010.92D
1.6	807, 807.04, 807.05, 821, 821.03, 821.04, 843, 843.01	1.6	1968.09 - 1980.08		6010.92D

## 18

1.4	847 720, 847 722	1.4	1978.04 - 1986.07		6010.92D
1.6	841 717, 841 725, 841 726, A2M 723, A6M 725, A6M 726	1.6	1978.04 - 1986.07		6010.92D
1.6 Turbo	807 727, A5L 717, A5L 718	1.6	1980.10 - 1986.07		6010.92D
2.0	J6R 716	2.0	1981.10 - 1986.07		6010.92D
2.1 Diesel	852 710, J8S 711	2.1	1980.11 - 1986.07		6010.92D

## 20

1.6	843, 843 720, 843 721	1.6	1975.10 - 1983.12		6010.92D
2.0	829 700, 829 701, 829 702, 829 703, 829.01	2.0	1977.10 - 1983.12		6010.92D
2.1 Diesel	852	2.1	1980.10 - 1983.12		6010.92D
2.2	851 700	2.2	1980.10 - 1983.12		6010.92D

## 21 Kombi

1.7	F2N 710	1.7	1986.10 - 1988.12		6010.92D
2.0	J7R 750, J7R 751	2.0	1986.06 - 1988.12		6010.92D

## 25

2.0	J6R 706, J6R 707, J6R 760, J6R 762, J6R 763, J7R 722, J7R 723	2.0	1984.04 - 1993.12		6010.92D
2.0 12V	J7R 726	2.0	1989.06 - 1992.12		6010.92D
2.1 Diesel	J8S 706, J8S 736	2.1	1984.04 - 1992.12		6010.92D
2.1 Turbo-D	J8S 708, J8S 738	2.1	1984.04 - 1992.12		6010.92D
2.2	J7T 706, J7T 707, J7T 708, J7T 714, J7T 715, J7T 730, J7T 731, J7T 732, J7T 733	2.2	1984.04 - 1992.12		6010.92D
2.4 V6 Turbo	Z7U 702	2.4	1984.10 - 1990.05		6010.92D
2.5 V6 Turbo	Z7U 700	2.5	1990.01 - 1992.12		6010.92D
2.7 V6 Injection	Z7V 708, Z7V 709, Z7V 711	2.7	1984.04 - 1989.08		6010.92D
2.8 V6	Z7W 700	2.8	1987.06 - 1990.02		6010.92D
2.8 V6 Injection	Z7W 702, Z7W 706, Z7W 707, Z7W 709	2.8	1986.06 - 1992.12		6010.92D

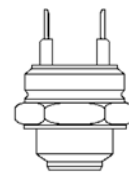

# RENAULT

	Engine	Ltr.	Year	Restriction*	Thermaswitches
<b>FUEGO</b>					
1.4	847 720	1.4	1980.02 - 1985.10		<b>6010.92D</b>
1.6 TS/GTS	843 723, 843 724, A6M 725, A6M 726	1.6	1980.10 - 1985.10		<b>6010.92D</b>
1.6 Turbo	A5L 750	1.6	1983.08 - 1985.10		<b>6010.92D</b>
2.0 TX/GTX	829 710, J6R 710, J6R 712, J6R 713, J6R 715, J6R 726	2.0	1980.10 - 1985.10		<b>6010.92D</b>
<b>TRAFIC (P6, T1, T3, T4, T5, T6, T7)</b>					
1.6	841 705, A1M 707, A1M 708	1.6	1984.01 - 1986.06		<b>6010.92D</b>
1.7	F1N 724	1.7	1986.06 - 1989.04		<b>6010.92D</b>

# SAAB

Engine

Ltr.

Year

Restriction\*

Thermaswitches

## 90

2.0	B 20 I	2.0	1984.08 - 1987.08		6010.95D
-----	--------	-----	-------------------	--	----------

## 99

1.7		1.7	1968.08 - 1971.05		6010.88D
-----	--	-----	-------------------	--	----------

1.85		1.9	1970.10 - 1974.05		6010.88D
------	--	-----	-------------------	--	----------

1.85 i		1.9	1971.10 - 1972.09		6010.88D
--------	--	-----	-------------------	--	----------

2.0	B 20 P, B20T	2.0	1972.10 - 1978.05		6010.88D
-----	--------------	-----	-------------------	--	----------

2.0 EMS	B 20 I	2.0	1972.04 - 1978.12		6010.88D
---------	--------	-----	-------------------	--	----------

2.0 GL	B 20 C, B 20 I	2.0	1974.09 - 1984.12		6010.88D
--------	----------------	-----	-------------------	--	----------

2.0 Turbo		2.0	1977.10 - 1980.06		6010.88D
-----------	--	-----	-------------------	--	----------

## 900 I

2.0	B202I, B202S	2.0	1985.10 - 1989.09 1983.09 - 1993.10		6010.88D 6010.92D
-----	--------------	-----	--	--	----------------------

2.0 -16	B202I, B202S	2.0	1989.01 - 1994.06		6010.92D
---------	--------------	-----	-------------------	--	----------

2.0 c	B 20, B201XC, B20T, BT 20	2.0	1978.09 - 1988.12		6010.92D
-------	---------------------------	-----	-------------------	--	----------

2.0 EMS	BI 20	2.0	1978.09 - 1980.12		6010.92D
---------	-------	-----	-------------------	--	----------

2.0 i	B201, B201XI, BI 20	2.0	1980.11 - 1990.08		6010.92D
-------	---------------------	-----	-------------------	--	----------

2.0 S Turbo-16	B202S	2.0	1991.07 - 1994.06		6010.92D
----------------	-------	-----	-------------------	--	----------

2.0 T8		2.0	1986.10 - 1989.09		6010.92D
--------	--	-----	-------------------	--	----------

2.0 Turbo	B201S, B201XL, BSI 20	2.0	1978.09 - 1991.12		6010.92D
-----------	-----------------------	-----	-------------------	--	----------

2.0 Turbo-16	B202L, B202XL	2.0	1984.02 - 1994.06		6010.92D
--------------	---------------	-----	-------------------	--	----------

2.0 Turbo-16 S	B202XL	2.0	1984.01 - 1993.12		6010.92D
----------------	--------	-----	-------------------	--	----------

2.1 16 S		2.1	1989.10 - 1992.07		6010.92D
----------	--	-----	-------------------	--	----------

## 9000

2.0 -16	B202I, B202XI, B202XI (KAT)	2.0	1985.12 - 1993.01		6010.92D
---------	-----------------------------	-----	-------------------	--	----------

2.0 -16 CD	B204E, B204I, B204S	2.0	1993.09 - 1998.12		6010.92D
------------	---------------------	-----	-------------------	--	----------

2.0 -16 CS	B202I, B204I	2.0	1989.01 - 1998.12		6010.92D
------------	--------------	-----	-------------------	--	----------

2.0 -16 ND Turbo	B202S, B204E, B204S	2.0	1993.09 - 1998.12		6010.88D
------------------	---------------------	-----	-------------------	--	----------

2.0 -16 Turbo	B202, B202XL	2.0	1984.09 - 1993.08		6010.88D
---------------	--------------	-----	-------------------	--	----------

2.0 -16 Turbo CD	B202L, B202S, B202XL, B204E	2.0	1988.09 - 1998.12		6010.88D
------------------	-----------------------------	-----	-------------------	--	----------

2.0 -16 Turbo CS	B202L	2.0	1988.09 - 1998.12		6010.88D
------------------	-------	-----	-------------------	--	----------

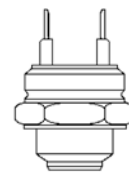

# SEAT

	Engine	Ltr.	Year	Restriction*	Thermaswitches
<b>131</b>					
1.5		1.5	1982.03 - 1985.01		<b>6010.85D</b>
1.6	132 BB OA O	1.6	1982.03 - 1985.01		<b>6010.85D</b>
2.0	131 C4.000	2.0	1978.06 - 1985.12		<b>6010.85D</b>
2.4 Diesel	8144.61	2.4	1978.06 - 1986.12		<b>6010.85D</b>
<b>ALHAMBRA</b>					
1.8 T 20V	AJH, AWC	1.8	1997.10 - 2010.03		<b>6037.95D</b>
1.9 TDI	1Z, AFN, AHU, ANU, ASZ, AUY, AVG, BVK	1.9	1996.04 - 2010.03		<b>6037.95D</b>
2.0 i	ADY, ATM	2.0	1996.04 - 2010.03		<b>6037.95D</b>
2.8 V6	AUE, AYL	2.8	2000.06 - 2010.03		<b>6037.95D</b>
<b>AROSA</b>					
1.0	AER, ALD, ALL, ANV, AUC	1.0	1997.05 - 2004.06 1997.05 - 2004.06		<b>6037.95D</b> <b>6039.95D</b>
1.4	AEX, AKK, AKV, ANW, APQ, AUD	1.4	1997.05 - 2004.06 1997.05 - 2004.06		<b>6037.95D</b> <b>6039.95D</b>
1.4 16V	AFK, AQQ, AUB	1.4	2000.01 - 2004.06 2000.01 - 2004.06		<b>6037.95D</b> <b>6039.95D</b>
1.7 SDI	AKU	1.7	1997.08 - 2004.06 1997.08 - 2004.06		<b>6037.95D</b> <b>6039.95D</b>
<b>CORDOBA (6K2/C2, 6K5)</b>					
1.0	ALD, ANV, AST, AUC, AVZ	1.0	1999.05 - 2002.10		<b>6037.95D</b>
1.0 16V	AST, AVZ	1.0	2000.05 - 2002.10		<b>6037.95D</b>
1.0 i	AER	1.0	1996.09 - 1999.06		<b>6037.95D</b>
1.4	AKK, ANW, APE, AQQ, AUA, AUB, AUD	1.4	1997.12 - 2002.12		<b>6037.95D</b>
1.4 16V	APE, AQQ, AUA, AUB	1.4	1999.06 - 2002.12		<b>6037.95D</b>
1.4 i	ABD, AEX, AKV, ANX, APQ	1.4	1994.06 - 1999.06	Chassis No →6K-TR099000	<b>6017.95D</b>
			1994.06 - 1999.06	Chassis No →6K-T	<b>6020.95D</b>
			1994.06 - 1999.06	Chassis No 6K-TR099001→	<b>6037.95D</b>
1.4 i 16V	AFH	1.4	1996.09 - 1999.06		<b>6037.95D</b>
1.6	AEH, AKL, ALM, APF, AUR	1.6	1999.05 - 2002.12		<b>6037.95D</b>
1.6 i	1F, ABU, AEE, AFT, ALM	1.6	1993.02 - 1999.06	Chassis No →6K-TR099000	<b>6017.95D</b>
			1993.02 - 1999.06	Chassis No →6K-T	<b>6020.95D</b>
			1993.02 - 1999.06	Chassis No 6K-TR099001→	<b>6037.95D</b>
1.7 SDI		1.7	1997.07 - 1999.06		<b>6037.95D</b>
1.8 i	ABS, ACC, ADZ	1.8	1993.02 - 1999.06	Chassis No →6K-TR099000	<b>6017.95D</b>
			1993.02 - 1999.06	Chassis No →6K-T	<b>6020.95D</b>
			1993.02 - 1999.06	Chassis No 6K-TR099001→	<b>6037.95D</b>
1.8 i 16V	ADL	1.8	1993.10 - 1996.08	Chassis No →6K-TR099000	<b>6017.95D</b>
			1993.10 - 1996.08	Chassis No →6K-T	<b>6020.95D</b>
			1993.10 - 1996.08	Chassis No 6K-TR099001→	<b>6037.95D</b>
1.8 T 20V Cupra	AQX, AYP	1.8	2000.07 - 2002.10		<b>6037.95D</b>

**SEAT**

	Engine	Ltr.	Year	Restriction*	Thermaswitches
1.9 D	1Y, AGR, ALH, ASV	1.9	1993.02 - 1996.08	Chassis No →6K-TR099000	<b>6017.95D</b>
			1993.02 - 1996.08	Chassis No →6K-T	<b>6020.95D</b>
			1993.02 - 2002.09	Chassis No 6K-TR099001→	<b>6037.95D</b>
1.9 SDI	AEY, AGP, AQM	1.9	1996.08 - 2002.12		<b>6037.95D</b>
1.9 TD	AAZ	1.9	1993.02 - 1996.08	Chassis No →6K-TR099000	<b>6017.95D</b>
			1993.02 - 1996.08	Chassis No →6K-T	<b>6020.95D</b>
			1993.02 - 1996.08	Chassis No 6K-TR099001→	<b>6037.95D</b>
1.9 TDI	1Z, AFN, AGR, AHU, ALH, ASK, ASV	1.9	1996.08 - 2002.12		<b>6037.95D</b>
2.0 i	2E, AGG	2.0	1993.02 - 1999.06	Chassis No →6K-TR099000	<b>6017.95D</b>
			1993.02 - 1999.06	Chassis No →6K-T	<b>6020.95D</b>
			1993.02 - 1999.06	Chassis No 6K-TR099001→	<b>6037.95D</b>
2.0 i 16V	ABF	2.0	1996.08 - 1999.06		<b>6037.95D</b>
<b>FURA</b>					
0.9	09 NCA, 100 GL 7000	0.9	1984.03 - 1986.12		<b>6016.92</b>
<b>IBIZA I (021A)</b>					
0.9	09 NCA, 146 A 000	0.9	1986.08 - 1993.05		<b>6020.92D</b>
1.2	021 A 1000	1.2	1984.11 - 1993.12		<b>6020.92D</b>
1.2 i	021 C.1000	1.2	1989.01 - 1993.05		<b>6020.92D</b>
1.5	021 A 2000	1.5	1984.11 - 1993.05		<b>6020.92D</b>
1.5 i	021 B.2000, 021 C.2000, 021 D.2000	1.5	1986.10 - 1993.05		<b>6020.92D</b>
1.7	021 A.3000, 021 B.3000	1.7	1991.01 - 1993.05		<b>6020.92D</b>
<b>IBIZA II (6K1)</b>					
1.0	AAU	1.0	1993.03 - 1996.09		<b>6017.95D</b>
			1993.03 - 1996.09		<b>6020.95D</b>
1.0 i	AER	1.0	1996.09 - 1999.08		<b>6037.95D</b>
1.3 i	2G, AAV	1.3	1993.03 - 1999.08	Chassis No →6K-TR099000	<b>6017.95D</b>
			1993.03 - 1999.08	Chassis No →6K-T	<b>6020.95D</b>
			1993.03 - 1999.08	Chassis No 6K-TR099001→	<b>6037.95D</b>
1.4 i	ABD, AEX, AKV, APQ	1.4	1993.09 - 1999.08	Chassis No →6K-TR099000	<b>6017.95D</b>
			1993.09 - 1999.08	Chassis No →6K-T	<b>6020.95D</b>
			1993.09 - 1999.08	Chassis No 6K-TR099001→	<b>6037.95D</b>
1.4 i 16V	AFH	1.4	1996.09 - 1999.08		<b>6037.95D</b>
1.6 i	1F, ABU, AEE, AFT, ALM	1.6	1993.03 - 1999.08	Chassis No →6K-TR099000	<b>6017.95D</b>
			1993.03 - 1999.08	Chassis No →6K-T	<b>6020.95D</b>
			1993.03 - 1999.08	Chassis No 6K-TR099001→	<b>6037.95D</b>

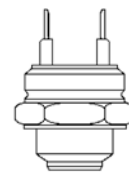

# SEAT

	Engine	Ltr.	Year	Restriction*	Thermaswitches
1.8 i	ABS, ADZ	1.8	1993.03 - 1999.08	Chassis No →6K-TR099000	<b>6017.95D</b>
			1993.03 - 1999.08	Chassis No →6K-T	<b>6020.95D</b>
			1993.03 - 1999.08	Chassis No 6K-TR099001→	<b>6037.95D</b>
1.8 i 16V	ADL	1.8	1993.11 - 1996.08		<b>6017.95D</b>
			1993.11 - 1996.08		<b>6020.95D</b>
1.9 D	1Y	1.9	1993.04 - 1996.08		<b>6017.95D</b>
			1993.04 - 1996.08		<b>6020.95D</b>
1.9 SDI	AEY	1.9	1996.08 - 1999.08		<b>6037.95D</b>
1.9 TD	AAZ	1.9	1993.03 - 1996.08		<b>6017.95D</b>
			1993.03 - 1996.08		<b>6020.95D</b>
1.9 TDI	1Z, AFN, AHU	1.9	1996.08 - 1999.08		<b>6037.95D</b>
2.0 i	2E, AGG	2.0	1993.03 - 1999.08	Chassis No →6K-TR099000	<b>6017.95D</b>
			1993.03 - 1999.08	Chassis No →6K-T	<b>6020.95D</b>
			1993.03 - 1999.08	Chassis No 6K-TR099001→	<b>6037.95D</b>
2.0 i 16V	ABF	2.0	1996.08 - 1999.08		<b>6037.95D</b>
<b>IBIZA III (6K1)</b>					
1.0	ALD, ANV, AUC	1.0	1999.08 - 2002.02		<b>6037.95D</b>
1.0 16V	AST, AVZ	1.0	2000.05 - 2002.02		<b>6037.95D</b>
1.4	AKK, ANW, AUD	1.4	1999.08 - 2002.02		<b>6037.95D</b>
1.4 16V	APE, AQQ, AUA, AUB	1.4	1999.08 - 2002.02		<b>6037.95D</b>
1.6	AEH, AKL, ALM, APF, AUR	1.6	1999.08 - 2002.02		<b>6037.95D</b>
1.8 T 20V Cupra	AQX, AYP	1.8	2000.07 - 2002.02		<b>6037.95D</b>
1.9 SDI	AGP, AQM	1.9	1999.08 - 2002.02		<b>6037.95D</b>
1.9 TDI	AGR, ALH, ASK, ASV	1.9	1999.08 - 2002.02		<b>6037.95D</b>
<b>INCA</b>					
1.4 16V	AUA	1.4	2000.04 - 2003.06		<b>6037.95D</b>
1.4 i	AEX, AKV, APQ, AUD	1.4	1995.11 - 2003.06		<b>6037.95D</b>
1.6 i	1F, AEE, ALM	1.6	1995.11 - 2000.09		<b>6037.95D</b>
1.7 D	AHB	1.7	1996.09 - 2003.06		<b>6037.95D</b>
1.9 D	1Y	1.9	1995.11 - 2003.06		<b>6037.95D</b>
1.9 SDI	AEY, AYQ	1.9	1995.11 - 2003.06		<b>6037.95D</b>
1.9 TDI	ALH	1.9	1996.09 - 2003.06		<b>6037.95D</b>
<b>LEON (1M1) 2006&lt;--</b>					
1.4 16V	AHW, APE, AUA, AXP, BCA	1.4	1999.11 - 2006.06		<b>6037.95D</b>
			1999.11 - 2006.06		<b>6039.95D</b>
1.6	AEH, AKL, APF	1.6	1999.11 - 2006.06		<b>6037.95D</b>
			1999.11 - 2006.06		<b>6039.95D</b>
1.6 16 V	ATN, AUS, AZD, BCB	1.6	2000.09 - 2006.06		<b>6039.95D</b>
1.8 20V / T	AGN, AJQ, APG, APP, ARY, AUQ	1.8	1999.11 - 2006.06		<b>6037.95D</b>
			1999.11 - 2006.06		<b>6039.95D</b>
1.9 TDI	AGR, AHF, ALH, ASV	1.9	1999.11 - 2006.06		<b>6037.95D</b>
			1999.11 - 2006.06		<b>6039.95D</b>
<b>MALAGA</b>					
1.2	021 A 1000	1.2	1984.11 - 1993.12		<b>6020.92D</b>
1.2 i	021 C.1000	1.2	1989.12 - 1993.12		<b>6020.92D</b>
1.5	021 A 2000	1.5	1985.05 - 1993.12		<b>6020.92D</b>
1.5 i	021 A 2000, 021 B.2000, 021 C.2000, 021 D.2000	1.5	1986.10 - 1993.12		<b>6020.92D</b>

# SEAT

Engine

Ltr.

Year

Restriction\*

Thermaswitches

## MARBELLA

0.8	08 NCA	0.8	1986.08 - 1993.12		6020.92D
0.9	08 NCB, 09 NCA, 09 NCB, 100 GL 7000	0.9	1987.01 - 1998.10		6020.92D

## PANDA (141A)

0.9	100 GL 3000	0.9	1980.10 - 1986.12		6020.92D
-----	-------------	-----	-------------------	--	----------

## RONDA

1.2	021 A 1000	1.2	1984.10 - 1986.12		6010.92D
1.5	021 A 2000	1.5	1984.09 - 1986.12		6010.92D

## TERRA

0.9	09 NCA, 09 NCB	0.9	1987.01 - 1996.12		6020.92D
-----	----------------	-----	-------------------	--	----------

## TOLEDO I

1.6 i	1F, ABN, AFT, EZ	1.6	1991.05 - 1999.03		6017.95D
1.8 16V	KR, PL	1.8	1991.05 - 1999.03		6017.95D
1.8 i	ABS, ADZ, RP	1.8	1991.05 - 1996.12		6017.95D
1.9 D	1Y	1.9	1991.05 - 1999.03		6017.95D
1.9 TD	AAZ	1.9	1991.05 - 1999.03		6017.95D
1.9 TDI	1Z, AFN, AHU	1.9	1995.08 - 1999.03		6017.95D
2.0 i	2E, AGG	2.0	1991.05 - 1999.03		6017.95D
2.0 i 16V	ABF	2.0	1993.11 - 1999.03		6017.95D

## TOLEDO II

1.4 16V	AHW, APE, AUA, AXP, BCA	1.4	1999.07 - 2006.05		6039.95D
1.6 16V	AUS, AZD, BCB	1.6	2000.09 - 2006.05		6039.95D



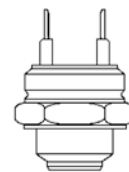

# SKODA

	Engine	Ltr.	Year	Restriction*	Thermaswitches
<b>105, 120</b>					
1.0 105	742, 10	1.0	1976.08 - 1990.12		<b>6010.92D</b>
1.2 120	742, 12, 742.12 X	1.2	1976.08 - 1990.12		<b>6010.92D</b>
<b>FABIA (6Y2, 6Y3, 6Y5)</b>					
1.0	AQV, ARV	1.0	1999.12 - 2002.08		<b>6037.95D</b>
1.4	AME, AQW, ATZ	1.4	1999.08 - 2008.03		<b>6037.95D</b>
1.9 SDI	ASY	1.9	1999.12 - 2008.03		<b>6037.95D</b>
1.9 TDI	ATD, AXR	1.9	2000.01 - 2008.03		<b>6037.95D</b>
<b>FELICIA I</b>					
1.3	135 L, 135B, 135M, 136B, 136M, AMG, AMH, AMJ	1.3	1994.10 - 1998.05	ohne Klimaanlage	<b>6010.95D</b>
			1994.10 - 1998.03	ohne Servolenkung	<b>6017.95D</b>
1.6	AEE, EA111	1.6	1995.08 - 1998.03	mit Klimaanlage	<b>6017.95D</b>
1.9 D	AEF	1.9	1995.10 - 1998.03		<b>6017.95D</b>
<b>FELICIA II</b>					
1.3	AMG, AMH	1.3	1998.01 - 2001.06	mit Klimaanlage für Fahrzeuge mit Servolenkung	<b>6017.95D</b>
1.6	AEE	1.6	1998.01 - 2001.06	mit Klimaanlage	<b>6017.95D</b>
1.9 D	AEF	1.9	1998.01 - 2001.06		<b>6017.95D</b>

# TALBOT

	Engine	Ltr.	Year	Restriction*	Thermaswitches
<b>1307-1510</b>					
1510 1.6	6J2A	1.6	1981.07 - 1982.06		6010.92D
Simca 1307 1.3	6G1D	1.3	1975.07 - 1981.08		6010.92D
Simca 1307 1.3S		1.3	1975.07 - 1978.12		6010.92D
Simca 1308 1.4	6Y2, 6Y2D	1.4	1978.11 - 1981.08		6010.92D
Simca 1510 1.4	6G1, 6Y2D	1.4	1980.01 - 1984.04		6010.92D
Simca 1510 1.6	6J1, 6J2	1.6	1978.10 - 1983.12		6010.92D
<b>HORIZON</b>					
1.1	E1B	1.1	1979.01 - 1984.09		6010.92D
1.3	2G1, 2G1-BTC	1.3	1978.02 - 1986.06		6010.92D
1.4	2Y1, 2Y1B, 2Y2, Y2	1.4	1979.07 - 1986.06		6010.92D
1.6	6J2A, J2A	1.6	1982.07 - 1986.06		6010.92D
1.9 Diesel	XUD9	1.9	1982.07 - 1986.06		6010.92D
<b>MURENA</b>					
1.6	X5J2A	1.6	1981.08 - 1985.01		6010.92D
2.1	5N2	2.1	1980.09 - 1984.07		6010.92D
2.1 S	X5N2	2.1	1983.04 - 1985.01		6010.92D
<b>RANCHO</b>					
1.4	X3Y2	1.4	1977.01 - 1984.07		6010.92D
<b>SAMBA (51A)</b>					
0.9	5C1(XV5), 5C1(XV8)	0.9	1981.01 - 1985.12		6010.92D
1.1	XW7	1.1	1981.01 - 1986.06		6010.92D
1.2 Rallye	129 D	1.2	1983.01 - 1986.10		6010.92D
1.4	150 D, XY7, XY8	1.4	1981.01 - 1986.10		6010.92D
1.4 Rallye	XY8	1.4	1983.01 - 1986.10		6010.92D
<b>SAMBA Cabriolet (51E)</b>					
1.4	XY8	1.4	1981.01 - 1986.06		6010.92D
<b>SIMCA 1100</b>					
0.9 LE		0.9	1976.10 - 1980.01		6010.92D
0.9 LS		0.9	1970.10 - 1972.05		6010.92D
1.1	3E1, 3E1A, E1/BTC	1.1	1968.10 - 1980.01		6010.92D
1.1 LE, LX, GLS, ES	3E1, 3E1A	1.1	1976.10 - 1980.01		6010.92D
1.1 LS, GLS	E1/BTC	1.1	1968.10 - 1977.09		6010.92D
1.2 Spezial		1.2	1971.10 - 1977.09		6010.92D
1.3 Spezial		1.3	1974.07 - 1976.11		6010.92D
1.3 Spezial TI	3G4	1.3	1972.10 - 1977.09		6010.92D
<b>SIMCA 1609/1610</b>					
1609 1.6	7R2	1.6	1976.09 - 1978.03		6010.92D
1610 1.8	7S2	1.8	1976.09 - 1980.12		6010.92D
1610 2.0	7T2	2.0	1976.09 - 1980.12		6010.92D
1610 2.0 D		1.9	1976.09 - 1980.12		6010.92D
<b>SOLARA</b>					
1.3	6G1D/VP	1.3	1980.02 - 1986.07		6010.92D
1.6	6J1, J1B	1.6	1981.09 - 1986.07		6010.92D

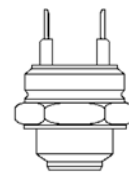

# VAUXHALL

	Engine	Ltr.	Year	Restriction*	Thermaswitches
<b>ASTRA</b>					
1.2	12 S	1.2	1979.10 - 1984.08		<b>6010.100D</b>
1.2 S	12 S	1.2	1982.02 - 1984.08		<b>6010.100D</b>
1.3		1.3	1980.09 - 1984.08 1982.08 - 1984.08	Chassis No →J2791967 →J5273427	<b>6010.100D</b> <b>6010.95D</b>
			1982.08 - 1984.08	Chassis No J2791968→ J5273428→	<b>6031.100D</b>
1.3 S	13 S	1.3	1979.09 - 1984.08 1979.09 - 1984.08	Chassis No →J2791967 →J5273427	<b>6010.100D</b> <b>6010.95D</b>
			1979.09 - 1984.08	Chassis No J2791968→ J5273428→	<b>6031.100D</b>
1.6 D	16 D	1.6	1982.03 - 1986.08 1982.02 - 1986.08	Chassis No →J2791967 →JE222258	<b>6010.100D</b> <b>6010.95D</b>
1.6 S	16 S, 16 SH	1.6	1981.09 - 1986.08 1981.09 - 1986.08	Chassis No →J2791967 →J5273427	<b>6010.100D</b> <b>6010.95D</b>
			1981.09 - 1986.08	Chassis No J2791968→ J5273428→	<b>6031.100D</b>
1.8 GTE	18 E	1.8	1983.03 - 1986.08		<b>6010.100D</b>
<b>ASTRA Mk II</b>					
1.2	12 S	1.2	1984.09 - 1991.08	Chassis No →J2791967 →J5273427	<b>6010.95D</b>
			1984.09 - 1991.08	Chassis No J2791968→ J5273428→	<b>6031.100D</b>
1.3	13 S	1.3	1984.09 - 1991.08	Chassis No →J2791967 →J5273427	<b>6010.95D</b>
			1984.09 - 1991.08	Chassis No J2791968→ J5273428→	<b>6031.100D</b>
1.4 i	C 14 NZ	1.4	1990.01 - 1991.12		<b>6031.100D</b>
1.4 S	14 NV	1.4	1989.01 - 1991.08		<b>6031.100D</b>
1.6	16 S, 16 SH, 16 SV	1.6	1984.09 - 1991.08	Chassis No →J2791967 →J5273427	<b>6010.95D</b>
			1984.09 - 1991.08	Chassis No J2791968→ J5273428→	<b>6031.100D</b>
1.6 D	16 DA	1.6	1984.09 - 1991.08	Chassis No →J2791967 →JE222258	<b>6010.95D</b>

# VAUXHALL

	Engine	Ltr.	Year	Restriction*	Thermaswitches
1.6 i	16 SV, C 16 LZ, C 16 NZ, E 16 NZ	1.6	1987.01 - 1993.08	Chassis No →J2791967 →J5273427	<b>6010.95D</b>
			1987.01 - 1993.08	Chassis No J2791968→ J5273428→	<b>6031.100D</b>
1.6 S	16 S, 16 SH, 16 SV	1.6	1984.09 - 1991.12	Chassis No →J2791967 →J5273427	<b>6010.95D</b>
			1984.09 - 1991.12	Chassis No J2791968→ J5273428→	<b>6031.100D</b>
1.8	18 SE	1.8	1986.01 - 1990.12	Chassis No →J2791967 →J5273427	<b>6010.95D</b>
			1986.01 - 1990.12	Chassis No J2791968→ J5273428→	<b>6031.100D</b>
1.8 GTE	18 E, 18 SE	1.8	1984.09 - 1991.08	Chassis No →J2791967 →J5273427	<b>6010.95D</b>
			1984.09 - 1991.08	Chassis No J2791968→ J5273428→	<b>6031.100D</b>
1.8 i	18 E, 18 SE	1.8	1985.09 - 1991.08	Chassis No →J2791967 →J5273427	<b>6010.95D</b>
			1985.09 - 1991.08	Chassis No J2791968→ J5273428→	<b>6031.100D</b>
<b>ASTRA Mk III</b>					
1.4 i	C 14 NZ, C 14 SE	1.4	1991.01 - 2001.03	mit Klimaanlage	<b>6031.100D</b>
			1991.01 - 2001.03	mit Klimaanlage	<b>6031.88D</b>
1.4 i 16V	X 14 XE	1.4	1996.01 - 2001.03	mit Klimaanlage	<b>6031.100D</b>
			1996.01 - 2001.03	mit Klimaanlage	<b>6031.88D</b>
1.4 S	14 NV	1.4	1991.09 - 1998.02	mit Klimaanlage	<b>6031.100D</b>
			1991.09 - 1998.02	mit Klimaanlage	<b>6031.88D</b>
1.6 i	C 16 NZ, C 16 SE, E 16 NZ, X 16 SZ, X 16 SZR	1.6	1991.01 - 2001.03	mit Klimaanlage	<b>6031.100D</b>
			1991.01 - 2001.03	mit Klimaanlage	<b>6031.88D</b>
1.6 i 16V	X 16 XEL	1.6	1994.01 - 1998.09	mit Klimaanlage	<b>6031.100D</b>
			1994.01 - 1998.09	mit Klimaanlage	<b>6031.88D</b>
1.6 Si	C 16 SE	1.6	1991.03 - 1994.12	mit Klimaanlage	<b>6031.100D</b>
			1991.03 - 1994.12	mit Klimaanlage	<b>6031.88D</b>
1.7 D	17 D, 17 DR	1.7	1991.09 - 1998.02	mit Klimaanlage	<b>6031.88D</b>
1.7 TD	17 DT (TC4EE1), X 17 DTL	1.7	1991.12 - 1998.02	mit Klimaanlage	<b>6031.88D</b>
1.8 16V	C 18 XEL, X 18 XE	1.8	1994.11 - 2001.03	mit Klimaanlage	<b>6031.100D</b>
			1994.11 - 2001.03	mit Klimaanlage	<b>6031.88D</b>
1.8 i	C 18 NZ	1.8	1991.09 - 1998.09	mit Klimaanlage	<b>6031.100D</b>
			1991.09 - 1998.09	mit Klimaanlage	<b>6031.88D</b>
1.8 i 16V	C 18 XE, C 18 XEL	1.8	1993.06 - 1998.02	mit Klimaanlage	<b>6031.100D</b>
			1993.06 - 1998.02	mit Klimaanlage	<b>6031.88D</b>
2.0 i	C 20 NE	2.0	1991.09 - 1998.09	mit Klimaanlage	<b>6031.100D</b>
			1991.09 - 1998.09	mit Klimaanlage	<b>6031.88D</b>
2.0 i 16V	C 20 XE, X 20 XEV	2.0	1991.09 - 1998.09	mit Klimaanlage	<b>6031.100D</b>
			1991.09 - 1998.09	mit Klimaanlage	<b>6031.88D</b>

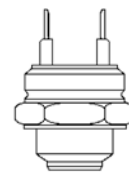

# VAUXHALL

	Engine	Ltr.	Year	Restriction*	Thermaswitches
<b>CALIBRA</b>					
2.0 i	C 20 NE	2.0	1990.06 - 1997.07	mit Klimaanlage	<b>6031.100D</b>
			1990.06 - 1997.07	mit Klimaanlage	<b>6031.88D</b>
2.0 i 16V	C 20 XE, X 20 XEV	2.0	1990.06 - 1994.02	mit Klimaanlage	<b>6031.100D</b>
			1990.06 - 1997.07	mit Klimaanlage	<b>6031.88D</b>
2.0 i Turbo	C 20 LET	2.0	1992.03 - 1997.07	mit Klimaanlage	<b>6031.100D</b>
<b>CARLTON Mk III</b>					
1.8	E 18 NVR	1.8	1987.09 - 1994.03		<b>6010.95D</b>
1.8 i	18 SEH	1.8	1986.09 - 1994.03		<b>6010.95D</b>
1.8 N	18 NV	1.8	1986.09 - 1987.08		<b>6010.95D</b>
1.8 S	18 SV	1.8	1986.09 - 1994.03		<b>6010.95D</b>
2.0	C 20 NE, C 20 NEF, C 20 NEJ	2.0	1986.09 - 1994.03	Chassis No →P1132203	<b>6010.95D</b>
			1990.09 - 1994.03	Chassis No P1132204→	<b>6031.105D</b>
2.0 i	20 SE, C 20 NEJ	2.0	1986.09 - 1994.03	Chassis No →P1132203	<b>6010.95D</b>
			1990.09 - 1994.03	Chassis No P1132204→	<b>6031.105D</b>
2.2 TD	23 YDT	2.2	1986.09 - 1988.08	Chassis No →K1000098	<b>6010.95D</b>
			1986.09 - 1988.08	Chassis No K1000099→	<b>6031.105D</b>
2.3 D	23 YD	2.3	1986.09 - 1994.03	Chassis No →K1000098	<b>6010.95D</b>
			1986.09 - 1994.03	Chassis No K1000099→	<b>6031.105D</b>
2.3 TD Interc.	23 DTR	2.3	1988.08 - 1994.03	Chassis No →K1000098	<b>6010.95D</b>
			1988.08 - 1994.03	Chassis No K1000099→	<b>6031.105D</b>
2.4 i	C 24 NE	2.4	1988.09 - 1994.03		<b>6010.95D</b>
2.6 i	C 26 NE	2.6	1990.09 - 1994.03	Chassis No →P1132203	<b>6010.95D</b>
			1990.09 - 1994.03	Chassis No P1132204→	<b>6031.105D</b>
3.0 3000 24V	C 30 SE	3.0	1989.09 - 1994.03		<b>6010.95D</b>
3000	C 30 LE, C 30 NE	2.9	1987.03 - 1994.03	Chassis No →P1132203	<b>6010.95D</b>
			1988.03 - 1994.03	Chassis No P1132204→	<b>6031.105D</b>
3000 24V	C 30 SEJ	3.0	1989.09 - 1994.03	Chassis No →P1132203	<b>6010.95D</b>
			1989.09 - 1994.03	Chassis No P1132204→	<b>6031.105D</b>
<b>CAVALIER Mk II</b>					
1.3	13 NB	1.3	1981.09 - 1988.08		<b>6010.95D</b>
1.3 N	13 N	1.3	1981.09 - 1988.08	Chassis No →J2791967 →J5273427	<b>6010.95D</b>
			1981.09 - 1988.08	Chassis No J2791968→ J5273428→	<b>6031.100D</b>

# VAUXHALL

	Engine	Ltr.	Year	Restriction*	Thermaswitches
1.3 S	13 S	1.3	1981.09 - 1988.08	Chassis No →J2791967 →J5273427	<b>6010.95D</b>
			1981.09 - 1988.08	Chassis No J2791968→ J5273428→	<b>6031.100D</b>
1.6	16 SH	1.6	1983.10 - 1988.08		<b>6010.95D</b>
1.6 i	C 16 LZ, C 16 NZ, E 16 NZ	1.6	1986.08 - 1988.08	Chassis No →J2791967 →J5273427	<b>6010.95D</b>
			1986.08 - 1988.08	Chassis No J2791968→ J5273428→	<b>6031.100D</b>
1.6 N	16 N	1.6	1981.09 - 1988.08		<b>6010.95D</b>
1.6 S	16 S, 16 SH	1.6	1981.09 - 1988.08		<b>6010.95D</b>
1.8	E 18 NV	1.8	1986.08 - 1988.08	Chassis No →J2791967 →J5273427	<b>6010.95D</b>
			1986.08 - 1988.08	Chassis No J2791968→ J5273428→	<b>6031.100D</b>
1.8 i	18 E, 18 SE, C 18 NE	1.8	1981.09 - 1988.08		<b>6010.95D</b>
1800i	18 SE	1.8	1985.03 - 1988.10		<b>6010.95D</b>
2.0	20 E, 20 S	2.0	1986.08 - 1987.08		<b>6010.95D</b>
2.0 i	20 NE, C 20 NE	2.0	1986.09 - 1988.08		<b>6010.95D</b>
2.0 SRi 130	20 SEH	2.0	1987.03 - 1988.08		<b>6010.95D</b>
2000i	20 SE	2.0	1986.09 - 1988.08		<b>6010.95D</b>
<b>CAVALIER Mk III</b>					
1.4 S	14 NV	1.4	1988.09 - 1995.11	Chassis No →KV999999 →K5999999 →L1000123	<b>6031.100D</b>
1.6	16 SV	1.6	1988.09 - 1993.05	Chassis No →KV999999 →K5999999 →L1000123	<b>6031.100D</b>
2.0 i	20 NE, 20 SEH, C 20 NE	2.0	1988.09 - 1995.11	Chassis No →KV999999 →K5999999 →L1000123	<b>6031.100D</b>
2.0 SRi	20 SEH	2.0	1988.09 - 1992.09	Chassis No →KV999999 →K5999999 →L1000123	<b>6031.100D</b>
<b>COMBO Mk I</b>					
1.2	C 12 NZ, X 12 SZ	1.2	1994.07 - 2001.10		<b>6031.100D</b>
1.4	C 14 NZ, C 14 SE	1.4	1994.07 - 2001.10		<b>6031.100D</b>
<b>CORSA Mk II</b>					
1.0 i 12V	X 10 XE	1.0	1996.11 - 2000.09		<b>6031.100D</b>
1.2 i	C 12 NZ, X 12 SZ	1.2	1993.03 - 2000.09		<b>6031.100D</b>
1.2 i 16V	X 12 XE	1.2	1998.03 - 2000.09		<b>6031.100D</b>
1.4 i	C 14 NZ, X 14 SZ	1.4	1993.03 - 2000.09		<b>6031.100D</b>
1.4 i 16V	X 14 XE	1.4	1994.09 - 2000.09		<b>6031.100D</b>
1.4 i S	C 14 SE	1.4	1993.03 - 2000.09		<b>6031.100D</b>
1.6 GSI 16V	C 16 XE	1.6	1993.03 - 2000.09		<b>6031.100D</b>
1.6 i 16V	X 16 XE	1.6	1994.09 - 2000.09		<b>6031.100D</b>

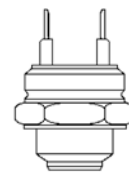

# VAUXHALL

	Engine	Ltr.	Year	Restriction*	Thermaswitches
<b>CORSA Convertible</b>					
1.4 i 16V	X 14 XE	1.4	1998.01 -		<b>6031.100D</b>
<b>CORSAVAN Mk II</b>					
1.4 i	C 14 NZ	1.4	1994.01 - 2000.09		<b>6031.100D</b>
<b>NOVA</b>					
1.0	10 S	1.0	1982.09 - 1987.10	Chassis No →J4999999	<b>6010.95D</b>
			1982.09 - 1993.03	Chassis No K4000001→	<b>6031.100D</b>
1.2	12 NV	1.2	1990.01 - 1994.10	Chassis No →J4999999	<b>6010.95D</b>
			1990.01 - 1994.10	Chassis No K4000001→	<b>6031.100D</b>
1.2 i	12 NC, C 12 NZ, E 12 GV	1.2	1985.01 - 1993.03	Chassis No →J4999999	<b>6010.95D</b>
			1985.01 - 1993.03	Chassis No K4000001→	<b>6031.100D</b>
1.2 N	12 NC, 12 NV, E 12 GV	1.2	1985.01 - 1993.03	Chassis No →J4999999	<b>6010.95D</b>
			1985.01 - 1993.03	Chassis No K4000001→	<b>6031.100D</b>
1.2 S	12 S, 12 ST	1.2	1982.09 - 1990.02	Chassis No →J4999999	<b>6010.95D</b>
			1982.09 - 1990.02	Chassis No K4000001→	<b>6031.100D</b>
1.3 i	13 NB, C 13 N	1.3	1985.09 - 1993.03	Chassis No →J4999999	<b>6010.95D</b>
			1985.09 - 1993.03	Chassis No K4000001→	<b>6031.100D</b>
1.3 S	13 SB	1.3	1982.09 - 1989.10	Chassis No →J4999999	<b>6010.95D</b>
			1982.09 - 1989.10	Chassis No K4000001→	<b>6031.100D</b>
1.4	14 NV, C 14 NZ, C 14 SE	1.4	1990.09 - 1993.03		<b>6031.100D</b>
1.4 i	C 14 NZ	1.4	1990.01 - 1993.03	Chassis No →J4999999	<b>6010.95D</b>
			1990.01 - 1993.03	Chassis No K4000001→	<b>6031.100D</b>
1.4 i S	C 14 SE	1.4	1991.09 - 1993.03	Chassis No →J4999999	<b>6010.95D</b>
			1991.09 - 1993.03	Chassis No K4000001→	<b>6031.100D</b>
1.4 S	14 NV	1.4	1990.01 - 1993.03	Chassis No →J4999999	<b>6010.95D</b>
			1990.01 - 1993.03	Chassis No K4000001→	<b>6031.100D</b>
1.6 GSI	C 16 SE, C 16 SEI, E 16 SE	1.6	1988.05 - 1993.03	Chassis No →J4999999	<b>6010.95D</b>
			1988.05 - 1993.03	Chassis No K4000001→	<b>6031.100D</b>
<b>OMEGA</b>					
2.0	20 SE, X 20 SE	2.0	1994.03 - 1999.09	mit Klimaanlage	<b>6031.100D</b>
2.0 16V	X 20 XEV	2.0	1994.03 - 2001.02	mit Klimaanlage	<b>6031.100D</b>
2.2 16V	Y 22 XE, Z 22 XE	2.2	1994.01 - 2003.06	mit Klimaanlage	<b>6031.100D</b>

# Thermoswitch

## VAUXHALL

	Engine	Ltr.	Year	Restriction*	Thermoswitches
2.5 V6	X 25 XE	2.5	1994.03 - 2000.09	ohne Klimaanlage Chassis No R1000001→ →T1003097	<b>6031.100D</b>
			1994.03 - 2000.09	ohne Klimaanlage Chassis No T1003098→	<b>6031.105D</b>
3.0 V6	X 30 XE	3.0	1994.04 - 2000.07	ohne Klimaanlage Chassis No R1000001→ →T1003097	<b>6031.100D</b>
			1994.04 - 2000.07	ohne Klimaanlage Chassis No T1003098→	<b>6031.105D</b>
<b>SENATOR</b>					
3.0	30 NE	3.0	1988.01 - 1990.09	Chassis No →0109241	<b>6010.95D</b>
			1988.01 - 1990.09	Chassis No 0109242→	<b>6031.105D</b>
3.0 i	C 30 NE	3.0	1988.01 - 1993.09	Chassis No →0109241	<b>6010.95D</b>
			1988.01 - 1993.09	Chassis No 0109242→	<b>6031.105D</b>
<b>SINTRA</b>					
2.2 DTI	X 22 DTH	2.2	1997.07 - 1999.04		<b>6031.105D</b>
2.2 i 16 V	X 22 XE	2.2	1996.11 - 1999.04		<b>6031.105D</b>
3.0 i 24V	X 30 XE	3.0	1996.11 - 1999.04		<b>6031.105D</b>
<b>TIGRA</b>					
1.4 16V	X 14 XE	1.4	1994.07 - 2000.12		<b>6031.100D</b>
1.6 16V	X 16 XE	1.6	1994.07 - 2000.12		<b>6031.100D</b>
<b>VECTRA</b>					
1.6 i 16V	X 16 XEL, Y 16 XE, Z 16 XE	1.6	1995.08 - 2001.10	ohne Klimaanlage	<b>6031.100D</b>
2.0 i 16V	X 20 XEV	2.0	1995.10 - 2001.01		<b>6031.88D</b>



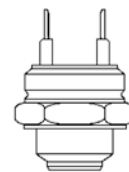

# VOLKSWAGEN

	Engine	Ltr.	Year	Restriction*	Thermaswitches
<b>BORA</b>					
1.6	AEH, AKL, APF	1.6	1998.10 - 1999.04 1998.10 - 1999.04		<b>6037.95D</b> <b>6039.95D</b>
1.8	AGN, BAF	1.8	1998.10 - 1999.04 1998.10 - 1999.04		<b>6037.95D</b> <b>6039.95D</b>
1.9 SDI	AGP, AQM	1.9	1998.10 - 1999.04 1998.10 - 1999.04		<b>6037.95D</b> <b>6039.95D</b>
1.9 TDI	AGR, AHF, AJM, ALH, ASV, AUY	1.9	1998.10 - 1999.04 1998.10 - 1999.04		<b>6037.95D</b> <b>6039.95D</b>
2.0	APK, AQY, AZG, AZH, AZJ, BBW	2.0	1998.10 - 1999.04 1998.10 - 1999.04		<b>6037.95D</b> <b>6039.95D</b>
2.3 V5	AGZ	2.3	1998.12 - 1999.04 1998.12 - 1999.04		<b>6037.95D</b> <b>6039.95D</b>
<b>CADDY I</b>					
1.5	JB	1.5	1982.08 - 1983.07 1982.08 - 1983.07		<b>6017.95D</b> <b>6020.95D</b>
1.6	EM, EW	1.6	1983.01 - 1992.07 1982.10 - 1992.07		<b>6017.95D</b> <b>6020.95D</b>
1.6 D	JK, ME	1.6	1982.08 - 1992.07 1982.08 - 1992.07		<b>6017.95D</b> <b>6020.95D</b>
1.8	JH	1.8	1985.08 - 1992.07 1985.08 - 1992.07		<b>6017.95D</b> <b>6020.95D</b>
<b>CADDY II (9K9)</b>					
1.4	AEX, AKV, APQ, AUA, AUD	1.4	1995.11 - 2004.01		<b>6037.95D</b>
1.4 16V	AUA	1.4	2000.08 - 2004.01		<b>6037.95D</b>
1.6	1F, AEE	1.6	1995.11 - 2000.09		<b>6037.95D</b>
1.7 SDI	AHB	1.7	1996.07 - 2000.09		<b>6037.95D</b>
1.9 D	1Y	1.9	1995.11 - 2004.01		<b>6037.95D</b>
1.9 SDI	AEY, AYQ	1.9	1995.11 - 2004.01		<b>6037.95D</b>
1.9 TDI	1Z, AHU, ALE, ALH	1.9	1996.09 - 2004.01		<b>6037.95D</b>
60 1.4	AEX, APQ, AUD	1.4	1995.11 - 2004.01		<b>6037.95D</b>
75 1.6	1F, AEE	1.6	1995.11 - 2000.09		<b>6037.95D</b>
<b>CADDY II Pick-up (9U7)</b>					
1.6	AEE	1.6	1996.06 - 2000.12 1996.06 - 1998.07	mit Klimaanlage ohne Klimaanlage Chassis No →9U-X-000 500	<b>6017.95D</b> <b>6010.95D</b>
1.9 D	AEF	1.9	1996.06 - 2000.12		<b>6017.95D</b>
<b>CORRADO</b>					
1.8 16V	KR	1.8	1989.04 - 1992.07 1989.04 - 1992.07	Chassis No →50P020000 Chassis No 50R000001→	<b>6017.95D</b> <b>6037.95D</b>
1.8 G60	PG	1.8	1988.09 - 1993.09 1988.09 - 1993.09	Chassis No →50P020000 Chassis No 50R000001→	<b>6017.95D</b> <b>6037.95D</b>
2.0 i	2E, ADY	2.0	1993.04 - 1995.12 1993.04 - 1995.12	Chassis No →50P020000 Chassis No 50R000001→	<b>6017.95D</b> <b>6037.95D</b>

## VOLKSWAGEN

	Engine	Ltr.	Year	Restriction*	Thermaswitches
2.0 i 16V	9A	2.0	1991.08 - 1995.12	Chassis No →50P020000	<b>6017.95D</b>
			1991.08 - 1995.12	Chassis No 50R000001→	<b>6037.95D</b>
2.9 VR6	ABV	2.9	1991.08 - 1995.12	Chassis No →50P020000	<b>6017.95D</b>
			1991.08 - 1995.12	Chassis No 50R000001→	<b>6037.95D</b>
<b>DERBY (86, 86C, 80)</b>					
0.9	HA	0.9	1977.02 - 1981.09	Chassis No →868 2600 000	<b>6010.92D</b>
			1977.02 - 1981.09	Chassis No 869 2500 001→	<b>6020.95D</b>
1.0	GL, HZ	1.0	1981.08 - 1984.12		<b>6017.95D</b>
			1981.08 - 1984.12		<b>6020.95D</b>
1.1	HB	1.1	1981.10 - 1983.07		<b>6017.95D</b>
			1977.02 - 1981.09	Chassis No →868 2600 000	<b>6010.92D</b>
			1977.02 - 1983.07	Chassis No 869 2500 001→	<b>6020.95D</b>
1.3	GK, HH, HJ, HK	1.3	1981.08 - 1984.12		<b>6017.95D</b>
			1977.02 - 1981.09	Chassis No →868 2600 000	<b>6010.92D</b>
			1977.02 - 1984.12	Chassis No 869 2500 001→	<b>6020.95D</b>
<b>GOLF I (17)</b>					
1.1	FA, FJ, GG, HC	1.1	1974.04 - 1983.07		<b>6010.92D</b>
			1981.01 - 1983.07		<b>6017.95D</b>
			1981.01 - 1983.07		<b>6020.95D</b>
1.3	GF	1.3	1979.08 - 1983.07		<b>6017.95D</b>
			1979.08 - 1983.07		<b>6020.95D</b>
1.5	FH, JB	1.5	1974.04 - 1975.12		<b>6010.92D</b>
			1977.08 - 1983.07		<b>6017.95D</b>
			1977.08 - 1983.07		<b>6020.95D</b>
1.5 D	CK	1.5	1976.08 - 1980.07		<b>6020.95D</b>
1.6	EM, FN, FP	1.6	1975.08 - 1984.02		<b>6010.92D</b>
1.6 D	CR, JK	1.6	1980.08 - 1983.07		<b>6017.95D</b>
			1980.08 - 1983.07		<b>6020.95D</b>
1.6 GTI	EG	1.6	1976.08 - 1982.07		<b>6010.92D</b>
			1976.08 - 1982.07		<b>6020.95D</b>
1.6 TD	CY	1.6	1982.03 - 1983.07		<b>6017.95D</b>
			1982.03 - 1983.07		<b>6020.95D</b>
1.8 GTI	DX, JJ	1.8	1982.08 - 1983.12		<b>6017.95D</b>
			1982.08 - 1983.12		<b>6020.95D</b>
<b>GOLF I Cabriolet (155)</b>					
1.6	EW, HN, RE	1.6	1983.08 - 1992.04		<b>6017.95D</b>
			1983.08 - 1992.04		<b>6020.95D</b>
1.8	2H, DX, EV, EX, JH, PB	1.8	1982.08 - 1993.04		<b>6017.95D</b>
			1982.08 - 1993.04		<b>6020.95D</b>
<b>GOLF II (19E, 1G1)</b>					
1.0	GN, HZ	1.0	1983.11 - 1991.10		<b>6017.95D</b>
			1983.11 - 1991.10		<b>6020.95D</b>
1.3	2G, GT, HK, MH, NU, NZ	1.3	1983.08 - 1992.12		<b>6017.95D</b>
			1983.08 - 1992.12		<b>6020.95D</b>

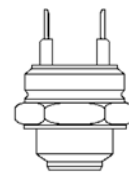

# VOLKSWAGEN

	Engine	Ltr.	Year	Restriction*	Thermaswitches
1.6	ABN, EZ, HM, PN, RF	1.6	1983.08 - 1992.12 1983.08 - 1992.12		<b>6017.95D</b> <b>6020.95D</b>
1.6 D	JP, ME	1.6	1983.08 - 1991.10 1983.08 - 1991.10		<b>6017.95D</b> <b>6020.95D</b>
1.6 TD	1V, JR, MF, RA, SB	1.6	1983.08 - 1991.10 1983.08 - 1991.10		<b>6017.95D</b> <b>6020.95D</b>
1.8	1P, GU, GX, HV, RH	1.8	1984.08 - 1991.10 1984.08 - 1991.10		<b>6017.95D</b> <b>6020.95D</b>
1.8 GTI	DX, EV, GZ, PB, PF, RD	1.8	1983.08 - 1991.10 1983.08 - 1991.10		<b>6017.95D</b> <b>6020.95D</b>
1.8 GTI 16V	KR, PL	1.8	1986.02 - 1991.10 1986.02 - 1991.10		<b>6017.95D</b> <b>6020.95D</b>
1.8 GTI G60	1H, PG	1.8	1988.08 - 1991.07 1988.08 - 1991.07		<b>6017.95D</b> <b>6020.95D</b>
1.8 i	GX, RP	1.8	1987.08 - 1991.10 1987.08 - 1991.10		<b>6017.95D</b> <b>6020.95D</b>
<b>GOLF III (1H1, 1H5)</b>					
1.4	ABD, AEX, APQ	1.4	1991.10 - 1999.04 1991.10 - 1999.04 1991.10 - 1999.04 1991.10 - 1999.04	Chassis No →1H P 990 000 Chassis No →1H P 990 000 Chassis No 1H R 000 001→ Chassis No 1H R 000 001→	<b>6017.95D</b> <b>6020.95D</b> <b>6037.95D</b> <b>6039.95D</b>
1.6	ABU, AEA, AEE, AEK, AFT, AKS	1.6	1992.09 - 1999.04 1992.09 - 1999.04 1992.09 - 1999.04 1992.09 - 1999.04	Chassis No →1H P 990 000 Chassis No →1H P 990 000 Chassis No 1H R 000 001→ Chassis No 1H R 000 001→	<b>6017.95D</b> <b>6020.95D</b> <b>6037.95D</b> <b>6039.95D</b>
1.8	AAM, ABS, ACC, ADZ, ANN, ANP	1.8	1991.11 - 1999.04 1991.11 - 1999.04 1991.11 - 1999.04 1991.11 - 1999.04	Chassis No →1H P 990 000 Chassis No →1H P 990 000 Chassis No 1H R 000 001→ Chassis No 1H R 000 001→	<b>6017.95D</b> <b>6020.95D</b> <b>6037.95D</b> <b>6039.95D</b>
1.9 D	1Y	1.9	1991.11 - 1999.04 1991.11 - 1999.04 1991.11 - 1999.04 1991.11 - 1999.04	Chassis No →1H P 990 000 Chassis No →1H P 990 000 Chassis No 1H R 000 001→ Chassis No 1H R 000 001→	<b>6017.95D</b> <b>6020.95D</b> <b>6037.95D</b> <b>6039.95D</b>
1.9 SDI	AEY	1.9	1995.07 - 1999.04 1995.07 - 1999.04	Chassis No 1H R 000 001→ Chassis No 1H R 000 001→	<b>6037.95D</b> <b>6039.95D</b>

# Thermoswitch

## VOLKSWAGEN

	Engine	Ltr.	Year	Restriction*	Thermaswitches
1.9 TD	AAZ	1.9	1993.07 - 1999.04	Chassis No →1H P 990 000	<b>6017.95D</b>
			1993.07 - 1999.04	Chassis No →1H P 990 000	<b>6020.95D</b>
			1993.07 - 1999.04	Chassis No 1H R 000 001→	<b>6037.95D</b>
			1993.07 - 1999.04	Chassis No 1H R 000 001→	<b>6039.95D</b>
1.9 TD, GTD	AAZ	1.9	1991.11 - 1997.08	Chassis No →1H P 990 000	<b>6017.95D</b>
			1991.11 - 1997.08	Chassis No →1H P 990 000	<b>6020.95D</b>
			1991.11 - 1997.08	Chassis No 1H R 000 001→	<b>6037.95D</b>
			1991.11 - 1997.08	Chassis No 1H R 000 001→	<b>6039.95D</b>
1.9 TDI	1Z, AFN, AHU, ALE	1.9	1993.09 - 1999.04	Chassis No →1H P 990 000	<b>6017.95D</b>
			1993.09 - 1999.04	Chassis No →1H P 990 000	<b>6020.95D</b>
			1993.09 - 1999.04	Chassis No 1H R 000 001→	<b>6037.95D</b>
			1993.09 - 1999.04	Chassis No 1H R 000 001→	<b>6039.95D</b>
2.0	2E, ABA, ADY, AGG, AKR	2.0	1991.11 - 1999.04	Chassis No →1H P 990 000	<b>6017.95D</b>
			1991.11 - 1999.04	Chassis No →1H P 990 000	<b>6020.95D</b>
			1991.11 - 1999.04	Chassis No 1H R 000 001→	<b>6037.95D</b>
			1991.11 - 1999.04	Chassis No 1H R 000 001→	<b>6039.95D</b>
2.0 GTI 16V	ABF	2.0	1992.08 - 1997.08	Chassis No →1H P 990 000	<b>6017.95D</b>
			1992.08 - 1997.08	Chassis No →1H P 990 000	<b>6020.95D</b>
			1992.08 - 1997.08	Chassis No 1H R 000 001→	<b>6037.95D</b>
			1992.08 - 1997.08	Chassis No 1H R 000 001→	<b>6039.95D</b>
2.8 VR6	AAA	2.8	1992.01 - 1997.08	Chassis No →1H P 990 000	<b>6017.95D</b>
			1992.01 - 1997.08	Chassis No →1H P 990 000	<b>6020.95D</b>
			1992.01 - 1997.08	Chassis No 1H R 000 001→	<b>6037.95D</b>
			1992.01 - 1997.08	Chassis No 1H R 000 001→	<b>6039.95D</b>
2.9 VR6	ABV	2.9	1994.10 - 1999.04	Chassis No →1H P 990 000	<b>6017.95D</b>
			1994.10 - 1999.04	Chassis No →1H P 990 000	<b>6020.95D</b>
			1994.10 - 1999.04	Chassis No 1H R 000 001→	<b>6037.95D</b>
			1994.10 - 1999.04	Chassis No 1H R 000 001→	<b>6039.95D</b>

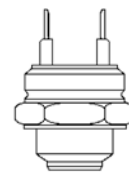

# VOLKSWAGEN

	Engine	Ltr.	Year	Restriction*	Thermaswitches
<b>GOLF III Cabriolet (1E7)</b>					
1.6	AEK, AFT, AKS	1.6	1994.10 - 1998.05 1994.10 - 1998.05		6037.95D 6039.95D
1.8	AAM, ABS, ADZ	1.8	1993.07 - 1998.05 1993.07 - 1998.05		6037.95D 6039.95D
1.9 TDI	1Z, AFN, AHU, ALE	1.9	1995.08 - 1998.05 1995.08 - 1998.05		6037.95D 6039.95D
2.0	2E, ADY, AGG, AKR	2.0	1993.07 - 1998.05 1993.07 - 1998.05		6037.95D 6039.95D
<b>GOLF IV (1J1, 1J5)</b>					
1.4 16V	AHW, AKQ, APE, AXP, BCA	1.4	1997.08 - 1999.04 1997.08 - 1999.04		6037.95D 6039.95D
1.6	AEH, AKL, APF	1.6	1997.08 - 1999.04 1997.08 - 1999.04		6037.95D 6039.95D
1.8	AGN, BAF	1.8	1997.08 - 1999.04 1997.08 - 1999.04		6037.95D 6039.95D
1.8 T	AGU, AQA, ARZ, AUM, AWD	1.8	1997.08 - 1999.04 1997.08 - 1999.04		6037.95D 6039.95D
1.9 SDI	AGP, AQM	1.9	1997.08 - 1999.04 1997.08 - 1999.04		6037.95D 6039.95D
1.9 TDI	AGR, AHF, AJM, ALH, ASV, AUY	1.9	1997.08 - 1999.04 1997.08 - 1999.04		6037.95D 6039.95D
2.0	APK, AQY, AZG, AZJ	2.0	1998.07 - 1999.04 1998.07 - 1999.04		6037.95D 6039.95D
2.3 V5	AGZ	2.3	1997.08 - 1999.04 1997.08 - 1999.04		6037.95D 6039.95D
<b>GOLF IV Cabriolet (1E7)</b>					
1.6	AFT, AKS	1.6	1998.06 - 2002.06 1998.06 - 2002.06		6037.95D 6039.95D
1.8	AAM, ADZ, ANN, ANP	1.8	1998.06 - 2002.06 1998.06 - 2002.06		6037.95D 6039.95D
1.9 TDI	AFN, AHU, ALE, AVG	1.9	1998.06 - 2002.06 1998.06 - 2002.06		6037.95D 6039.95D
2.0	AGG, AKR, ATU, AWF, AWG	2.0	1998.06 - 2002.06 1998.06 - 2002.06		6037.95D 6039.95D
<b>ILTIS</b>					
1.7	WL, YX	1.7	1979.03 - 1988.12		6020.95D
<b>JETTA I (16)</b>					
1.1	FA, GG	1.1	1978.08 - 1984.02 1978.08 - 1984.02		6017.95D 6020.95D
1.3	GF	1.3	1979.08 - 1984.02 1979.08 - 1984.02		6017.95D 6020.95D
1.5	JB	1.5	1978.08 - 1984.02 1978.08 - 1984.02		6017.95D 6020.95D
1.5 D	CK	1.5	1978.08 - 1980.07 1978.08 - 1980.07		6017.95D 6020.95D
1.6	FR	1.6	1978.08 - 1984.02 1978.08 - 1984.02		6017.95D 6020.95D
1.6 D	CR, JK	1.6	1980.08 - 1984.02 1980.08 - 1984.02		6017.95D 6020.95D
1.6 GLI	EG	1.6	1978.08 - 1982.07 1978.08 - 1982.07		6017.95D 6020.95D
1.6 TD	CY	1.6	1982.03 - 1984.02 1982.03 - 1984.02		6017.95D 6020.95D

# VOLKSWAGEN

	Engine	Ltr.	Year	Restriction*	Thermaswitches
1.8	DX, JJ	1.8	1982.08 - 1984.02 1982.08 - 1984.02		6017.95D 6020.95D
<b>JETTA II</b>					
1.3	2G, HK, MH, NZ	1.3	1984.01 - 1991.12 1984.01 - 1991.12		6017.95D 6020.95D
1.6	ABN, EZ, HM, PN, RF	1.6	1984.01 - 1992.07 1984.01 - 1992.07		6017.95D 6020.95D
1.6 D	JP, ME	1.6	1984.01 - 1991.10 1984.01 - 1991.10		6017.95D 6020.95D
1.6 TD	1V, JR, MF, RA, SB	1.6	1984.01 - 1991.10 1984.01 - 1991.10		6017.95D 6020.95D
1.8	1P, EV, GU, GX, GZ, HV, PB, PF, RD, RH, RP	1.8	1984.01 - 1991.10 1984.01 - 1991.10		6017.95D 6020.95D
1.8 16V	KR, PL	1.8	1986.08 - 1991.10 1986.08 - 1991.10		6017.95D 6020.95D
<b>LUPO</b>					
1.0	AER, ALD, ALL, ANV, AUC	1.0	1998.09 - 2005.07 1998.09 - 2005.07		6037.95D 6039.95D
1.2 TDI 3L	ANY, AYZ	1.2	1999.07 - 2005.07 1999.07 - 2005.07		6037.95D 6039.95D
1.4	AUD	1.4	2000.10 - 2005.07 2000.10 - 2005.07		6037.95D 6039.95D
1.4 16V	AFK, AHW, AKQ, APE, AQQ, AUA, AUB, BBY	1.4	1998.09 - 2005.07 1998.09 - 2005.07		6037.95D 6039.95D
1.4 FSI	ARR	1.4	2001.02 - 2005.07 2001.02 - 2005.07		6037.95D 6039.95D
1.6 GTI	AVY	1.6	2000.09 - 2005.07 2000.09 - 2005.07		6037.95D 6039.95D
1.7 SDI	AKU	1.7	1998.09 - 2005.07 1998.09 - 2005.07		6037.95D 6039.95D
<b>NEW BEETLE</b>					
1.6	AYD, BFS	1.6	2000.06 -		6037.95D
1.9 TDI	ALH	1.9	1998.01 - 2004.06		6037.95D
2.0	AEG, APK, AQY, AVH, AZG, AZJ, BEJ, BER, BEV, BHP, CBPA	2.0	1998.01 - 2001.05		6037.95D
<b>PASSAT (32/33)</b>					
1.3	FY, ZA, ZF	1.3	1973.05 - 1980.07 1973.05 - 1980.07	Chassis No →328 2300 000 Chassis No 329 2000 001→	6010.92D 6020.95D
1.5	YJ, ZB, ZC	1.5	1973.05 - 1975.12		6010.92D
1.5 D	CK	1.5	1977.02 - 1980.07 1977.02 - 1980.07	Chassis No →328 2300 000 Chassis No 329 2000 001→	6010.92D 6020.95D
1.6	FS, YN, YP	1.6	1975.08 - 1980.07 1975.08 - 1980.07	Chassis No →328 2300 000 Chassis No 329 2000 001→	6010.92D 6020.95D
1.6 D	CR	1.6	1979.02 - 1980.07 1979.02 - 1980.07	Chassis No →328 2300 000 Chassis No 329 2000 001→	6010.92D 6020.95D

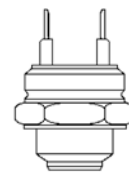

# VOLKSWAGEN

	Engine	Ltr.	Year	Restriction*	Thermaswitches
1.6 i	YS	1.6	1978.06 - 1980.07	Chassis No →328 2300 000	<b>6010.92D</b>
			1978.06 - 1980.07	Chassis No 329 2000 001→	<b>6020.95D</b>
<b>PASSAT (32B)</b>					
1.3	EP, EU, FY, FZ	1.3	1980.08 - 1986.07		<b>6017.95D</b>
			1980.08 - 1986.07		<b>6020.95D</b>
1.6	DT, PP, RL, WV, YN, YP	1.6	1980.08 - 1988.03		<b>6017.95D</b>
			1980.08 - 1988.03		<b>6020.95D</b>
1.6 D	CR, JK	1.6	1980.08 - 1988.03		<b>6017.95D</b>
			1980.08 - 1988.03		<b>6020.95D</b>
1.6 TD	CY, RA	1.6	1982.04 - 1988.03		<b>6017.95D</b>
			1982.04 - 1988.03		<b>6020.95D</b>
1.8	DS, DZ, JN, JV, RM	1.8	1983.01 - 1988.03		<b>6017.95D</b>
			1983.01 - 1988.03		<b>6020.95D</b>
1.9	WN	1.9	1981.01 - 1983.07		<b>6017.95D</b>
			1981.01 - 1983.07		<b>6020.95D</b>
2.0	HP, JS	2.0	1983.08 - 1988.03		<b>6017.95D</b>
			1983.08 - 1988.03		<b>6020.95D</b>
2.2	JT, KV, KX	2.2	1985.01 - 1988.03		<b>6017.95D</b>
			1985.01 - 1988.03		<b>6020.95D</b>
<b>PASSAT (35I, 3A2, 3A5)</b>					
1.6	1F, ABN, AEK, AFT, EZ	1.6	1988.02 - 1991.09		<b>6017.95D</b>
			1988.02 - 1991.09		<b>6020.95D</b>
			1994.07 - 1996.08		<b>6037.95D</b>
			1994.07 - 1996.08		<b>6039.95D</b>
1.6 TD	RA, SB	1.6	1988.08 - 1993.09		<b>6017.95D</b>
			1988.08 - 1993.09		<b>6020.95D</b>
1.8	AAM, ABS, ADZ, PB, PF, RP	1.8	1988.02 - 1997.05		<b>6017.95D</b>
			1988.02 - 1997.05		<b>6020.95D</b>
			1990.08 - 1997.05		<b>6037.95D</b>
			1990.08 - 1997.05		<b>6039.95D</b>
1.8 16V	KR	1.8	1988.04 - 1989.12		<b>6017.95D</b>
			1988.04 - 1989.12		<b>6020.95D</b>
1.8 G60	PG	1.8	1988.08 - 1997.05		<b>6017.95D</b>
1.8 GL	KR	1.8	1991.08 - 1993.09		<b>6017.95D</b>
			1991.08 - 1993.09		<b>6020.95D</b>
1.9 D	1Y	1.9	1989.05 - 1993.10		<b>6017.95D</b>
			1989.05 - 1993.10		<b>6020.95D</b>
1.9 TD	AAZ	1.9	1991.03 - 1997.05		<b>6037.95D</b>
			1991.03 - 1997.05		<b>6039.95D</b>
1.9 TDI	1Z, AFN, AHU	1.9	1993.10 - 1997.05		<b>6037.95D</b>
			1993.10 - 1997.05		<b>6039.95D</b>
2.0	2E, ADY, AEP, AGG	2.0	1990.02 - 1997.05		<b>6017.95D</b>
			1990.02 - 1997.05		<b>6020.95D</b>
			1995.03 - 1996.08		<b>6037.95D</b>
			1995.03 - 1996.08		<b>6039.95D</b>
2.0 16V	9A, ABF	2.0	1988.08 - 1993.09		<b>6017.95D</b>
			1988.08 - 1993.09		<b>6020.95D</b>
			1994.01 - 1997.05		<b>6037.95D</b>
			1994.01 - 1997.05		<b>6039.95D</b>
2.8 VR6	AAA	2.8	1991.06 - 1997.05		<b>6037.95D</b>
			1991.06 - 1997.05		<b>6039.95D</b>
2.9 VR6	ABV	2.9	1994.01 - 1997.05		<b>6037.95D</b>
			1994.01 - 1997.05		<b>6039.95D</b>

# VOLKSWAGEN

	Engine	Ltr.	Year	Restriction*	Thermaswitches
<b>PASSAT (3B2, 3B5)</b>					
1.6	ADP, AHL, ANA, ARM	1.6	1996.10 - 2000.11 1996.10 - 2000.11		<b>6017.95D</b> <b>6024.95D</b>
1.8	ADR, APT, ARG	1.8	1996.10 - 2000.11 1996.10 - 2000.11		<b>6017.95D</b> <b>6024.95D</b>
1.8 T	AEB, ANB, APU	1.8	1996.10 - 2000.11 1996.10 - 2000.11		<b>6017.95D</b> <b>6024.95D</b>
1.9 TDI	AFN, AHH, AHU, AJM, ATJ, AVG	1.9	1996.10 - 2000.11 1996.10 - 2000.11		<b>6017.95D</b> <b>6024.95D</b>
2.3 VR5	AGZ	2.3	1996.10 - 2000.11 1996.10 - 2000.11		<b>6017.95D</b> <b>6024.95D</b>
2.5 TDI	AFB, AKN	2.5	1998.07 - 2000.11 1998.07 - 2000.11		<b>6017.95D</b> <b>6024.95D</b>
2.8	AGE	2.8	1997.05 - 1999.09 1997.05 - 1999.09		<b>6017.95D</b> <b>6024.95D</b>
2.8 V6	ACK, ALG, APR, AQD	2.8	1996.08 - 2000.11 1996.08 - 2000.11		<b>6017.95D</b> <b>6024.95D</b>
<b>POLO (80, 86, 86C) 1975--&gt;1994</b>					
0.8	HE	0.8	1975.09 - 1981.09 1975.09 - 1981.09	Chassis No →868 2600 000 Chassis No 869 2500 001→	<b>6010.92D</b> <b>6020.95D</b>
0.9	HA	0.9	1981.10 - 1981.12 1975.09 - 1981.09 1975.09 - 1981.12	Chassis No →868 2600 000 Chassis No 869 2500 001→	<b>6017.95D</b> <b>6010.92D</b> <b>6020.95D</b>
1.0	AAK, AAU, ACM, GL, HZ	1.0	1981.10 - 1994.09 1981.10 - 1994.09 1985.08 - 1994.09 1985.08 - 1994.09	Chassis No →80 P 500 000 Chassis No →80 P 500 000 Chassis No 80 R 000 001→ Chassis No 80 R 000 001→	<b>6017.95D</b> <b>6020.95D</b> <b>6037.95D</b> <b>6039.95D</b>
1.1	HB, HC	1.1	1981.10 - 1989.09 1975.03 - 1981.09 1975.03 - 1989.09	Chassis No →868 2600 000 Chassis No 869 2500 001→	<b>6017.95D</b> <b>6010.92D</b> <b>6020.95D</b>
1.3	2G, 3F, AAV, GK, GT, HH, HJ, HK, MH, NZ	1.3	1976.12 - 1981.09 1981.10 - 1994.09 1976.12 - 1994.09 1987.07 - 1994.09 1987.07 - 1994.09	Chassis No →868 2600 000 Chassis No →80 P 500 000 Chassis No 869 2500 001→ →80 P 500 000 Chassis No 80 R 000 001→ Chassis No 80 R 000 001→	<b>6010.92D</b> <b>6017.95D</b> <b>6020.95D</b> <b>6037.95D</b> <b>6039.95D</b>
1.3 D	MN	1.3	1986.08 - 1990.08 1986.08 - 1990.08		<b>6017.95D</b> <b>6020.95D</b>



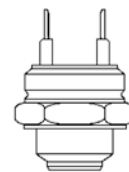

# VOLKSWAGEN

	Engine	Ltr.	Year	Restriction*	Thermaswitches
1.3 G40	PY	1.3	1987.01 - 1994.09	Chassis No →80 P 500 000	<b>6017.95D</b>
			1987.01 - 1994.09	Chassis No →80 P 500 000	<b>6020.95D</b>
			1990.08 - 1994.09	Chassis No 80 R 000 001→	<b>6037.95D</b>
			1990.08 - 1994.09	Chassis No 80 R 000 001→	<b>6039.95D</b>
1.4 D	1W	1.4	1990.08 - 1994.09	Chassis No →80 P 500 000	<b>6017.95D</b>
			1990.08 - 1994.09	Chassis No →80 P 500 000	<b>6020.95D</b>
			1990.08 - 1994.09	Chassis No 80 R 000 001→	<b>6037.95D</b>
			1990.08 - 1994.09	Chassis No 80 R 000 001→	<b>6039.95D</b>
<b>POLO (6N_) 1994--&gt;1999</b>					
1.0	AAU	1.0	1994.10 - 1999.12	Chassis No →80 P 500 000	<b>6017.95D</b>
			1994.10 - 1999.12	Chassis No →80 P 500 000	<b>6020.95D</b>
			1994.10 - 1999.12	Chassis No 80 R 000 001→	<b>6037.95D</b>
			1994.10 - 1999.12	Chassis No 80 R 000 001→	<b>6039.95D</b>
1.4	AEX, APQ	1.4	1998.05 - 1999.12		<b>6037.95D</b>
			1998.05 - 1999.12		<b>6039.95D</b>
1.7 SDI	AHG, AKU	1.7	1997.04 - 1999.12		<b>6037.95D</b>
			1997.08 - 1999.12		<b>6039.95D</b>
1.9 D	AEF	1.9	1994.10 - 1999.12		<b>6037.95D</b>
			1994.10 - 1999.12		<b>6039.95D</b>
1.9 SDI	AGD	1.9	1996.07 - 1999.12		<b>6037.95D</b>
			1996.07 - 1999.12		<b>6039.95D</b>
100 1.4 16V	AFH	1.4	1996.04 - 1999.10		<b>6037.95D</b>
			1996.04 - 1999.10		<b>6039.95D</b>
120 1.6 16V GTI	AJV	1.6	1998.09 - 1999.10		<b>6037.95D</b>
			1998.09 - 1999.10		<b>6039.95D</b>
45 1.0	AEV	1.0	1994.10 - 1996.09		<b>6037.95D</b>
			1994.10 - 1996.09		<b>6039.95D</b>
50 1.0	AER, ALL	1.0	1996.09 - 1999.10		<b>6037.95D</b>
			1996.09 - 1999.10		<b>6039.95D</b>
55 1.3	ADX	1.3	1994.10 - 1995.07		<b>6037.95D</b>
			1994.10 - 1995.07		<b>6039.95D</b>
55 1.4	AEX	1.4	1995.08 - 1999.10		<b>6037.95D</b>
			1995.08 - 1999.10		<b>6039.95D</b>
60 1.4	AEX, AKV, APQ	1.4	1995.07 - 1999.10		<b>6037.95D</b>
			1995.07 - 1999.10		<b>6039.95D</b>
60 1.7 SDI	AKU	1.7	1997.08 - 1999.10		<b>6037.95D</b>
			1997.08 - 1999.10		<b>6039.95D</b>
64 1.9 D	AEF	1.9	1994.10 - 1999.10		<b>6037.95D</b>
			1994.10 - 1999.10		<b>6039.95D</b>
64 1.9 SDI	AGD	1.9	1996.07 - 1999.10		<b>6037.95D</b>
			1996.07 - 1999.10		<b>6039.95D</b>
75 1.6	AEA, AEE, AHS	1.6	1994.10 - 1999.10		<b>6037.95D</b>
			1994.10 - 1999.10		<b>6039.95D</b>

# VOLKSWAGEN

Engine

Ltr.

Year

Restriction\*

Thermaswitches

## POLO (6KV2, 6KV5, 6N2) 1999-->2002

1.0	ALD, AUC	1.0	1999.10 - 2001.09 1999.10 - 2001.09		6037.95D 6039.95D
1.4	AEX, AKK, AKP, AKV, ANW, ANX, APQ, AUD	1.4	1997.05 - 2001.09 1997.05 - 2001.09		6037.95D 6039.95D
1.4 16V	AFK, AHW, APE, AQQ, AUA, AUB	1.4	1999.10 - 2001.09 1999.10 - 2001.09		6037.95D 6039.95D
1.6	AEE, AEH, AFT, AKL, ALM, APF, AUR	1.6	1997.05 - 2001.09 1997.05 - 2001.09		6037.95D 6039.95D
1.6 16V GTI	ARC, AVY	1.6	1999.10 - 2001.09		6039.95D
1.7 SDI	AKU, AKW	1.7	1997.08 - 2001.09 1997.08 - 2001.09		6037.95D 6039.95D
1.8	ADZ	1.8	1997.05 - 2001.09 1997.05 - 2001.09		6037.95D 6039.95D
1.9 D	AEF	1.9	1999.10 - 2001.09 1999.10 - 2001.09		6037.95D 6039.95D
1.9 SDI	AEY, AGD, AGP, AQM, ASX	1.9	1997.06 - 2001.09 1997.06 - 2001.09		6037.95D 6039.95D
1.9 TDI	AFN, AGR, AHU, ALE, ALH, ASV	1.9	1997.05 - 2001.09 1997.05 - 2001.09		6037.95D 6039.95D
100 1.6	AEH, AFT, AKL, APF, AUR	1.6	1995.12 - 2001.09 1995.12 - 2001.09		6037.95D 6039.95D
110 1.9 TDI	AFN, ASV	1.9	1998.06 - 2001.09 1998.06 - 2001.09		6037.95D 6039.95D
2.0	ADC	2.0	1999.08 - 2001.09 1999.08 - 2001.09		6037.95D 6039.95D
54 1.4	ANX	1.4	1998.01 - 1999.08 1998.01 - 1999.08		6037.95D 6039.95D
57 1.7 SDI	AKW	1.7	1997.07 - 2001.09 1997.07 - 2001.09		6037.95D 6039.95D
60 1.4	AEX, AKK, AKV, ANW, APQ, AUD	1.4	1995.12 - 2001.09 1995.12 - 2001.09		6037.95D 6039.95D
64 1.9 SDI	AEY	1.9	1995.12 - 1999.08 1995.12 - 1999.08		6037.95D 6039.95D
68 1.9 SDI	AGP, AQM	1.9	1999.08 - 2001.09 1999.08 - 2001.09		6037.95D 6039.95D
75 1.4 16V	APE, AUA	1.4	1999.10 - 2001.09 1999.10 - 2001.09		6037.95D 6039.95D
75 1.6	1F, AEE, ALM	1.6	1995.11 - 2001.09 1995.11 - 2001.09		6037.95D 6039.95D
90 1.8	ADD	1.8	1997.01 - 2001.09 1997.01 - 2001.09		6037.95D 6039.95D
90 1.9 TDI	AGR, AHU, ALE, ALH	1.9	1996.09 - 2001.09 1996.09 - 2001.09		6037.95D 6039.95D

## SANTANA (32B)

1.3	FZ	1.3	1981.08 - 1983.07 1981.08 - 1983.07		6017.95D 6020.95D
1.6	DT, WV, YP	1.6	1981.08 - 1984.12 1981.08 - 1984.12		6017.95D 6020.95D
1.6 D	CR, JK	1.6	1981.08 - 1984.12 1981.08 - 1984.12		6017.95D 6020.95D
1.6 TD	CY	1.6	1981.12 - 1984.12 1981.12 - 1984.12		6017.95D 6020.95D
1.8	DS	1.8	1983.01 - 1984.12 1983.01 - 1984.12		6017.95D 6020.95D
1.9	WN	1.9	1981.08 - 1983.07 1981.08 - 1983.07		6017.95D 6020.95D

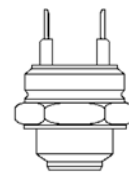

# VOLKSWAGEN

	Engine	Ltr.	Year	Restriction*	Thermaswitches
2.0	HP, JS	2.0	1983.08 - 1984.12 1983.08 - 1984.12		<b>6017.95D</b> <b>6020.95D</b>
<b>SCIROCCO (53, 53B)</b>					
1.5	JB	1.5	1980.08 - 1983.12 1980.08 - 1983.12		<b>6017.95D</b> <b>6020.95D</b>
1.6	EW, RE	1.6	1983.01 - 1990.07 1983.01 - 1990.07		<b>6017.95D</b> <b>6020.95D</b>
1.8	DX, EV, EX, JH, JJ, PB	1.8	1982.08 - 1992.07 1982.08 - 1992.07		<b>6017.95D</b> <b>6020.95D</b>
1.8 16V	KR, PL	1.8	1985.10 - 1992.07 1985.10 - 1992.07		<b>6017.95D</b> <b>6020.95D</b>
<b>SHARAN</b>					
1.8 T 20V	AJH, AWC	1.8	1997.09 -		<b>6037.95D</b>
1.9 TDI	1Z, AFN, AHU, ANU, ASZ, AUJ, AVG, BVK	1.9	1995.09 - 2000.04		<b>6037.95D</b>
2.0	ADY, ATM	2.0	1995.09 -		<b>6037.95D</b>
2.8 V6 24V	AYL	2.8	2000.04 -		<b>6037.95D</b>
2.8 VR6	AAA, AMY	2.8	1995.09 - 2000.04		<b>6037.95D</b>
<b>TRANSPORTER T3</b>					
1.6 D	CS	1.6	1981.01 - 1987.07	Chassis No 24 F 000 001→	<b>6087.87D</b>
1.6 TD	JX	1.6	1984.08 - 1992.07	Chassis No 24 F 000 001→	<b>6087.87D</b>
1.7 D	KY	1.7	1986.10 - 1992.07		<b>6087.87D</b>
1.9	DF, DG, DH, GW	1.9	1982.08 - 1992.07 1982.08 - 1992.07 1982.08 - 1992.07	Chassis No →24 E 200 000 Chassis No 24 D 000 001→ Chassis No 24 F 000 001→	<b>6017.95D</b> <b>6020.95D</b> <b>6087.87D</b>
2.1	DJ, MV, SR	2.1	1985.08 - 1992.07		<b>6087.87D</b>
2.1 i	SS	2.1	1989.07 - 1992.07		<b>6087.87D</b>
<b>TRANSPORTER T4</b>					
1.8	PD	1.8	1990.12 - 1992.07		<b>6087.87D</b>
1.9 D	1X	1.9	1990.07 - 2003.04 1990.07 - 2003.04	Chassis No →70 P 250 000 Chassis No 70 R 000 001→	<b>6087.87D</b> <b>6037.87D</b>
1.9 TD	ABL	1.9	1992.10 - 2003.04 1992.10 - 2003.04	Chassis No →70 P 250 000 Chassis No 70 R 000 001→	<b>6087.87D</b> <b>6037.87D</b>
2.0	AAC	2.0	1990.07 - 2003.04 1990.07 - 2003.04	Chassis No →70 P 250 000 Chassis No 70 R 000 001→	<b>6087.87D</b> <b>6037.87D</b>
2.4 D	AAB, AJA	2.4	1990.07 - 1998.09 1990.07 - 2003.04 1990.07 - 1998.09		<b>6037.81D</b> <b>6037.87D</b> <b>6087.87D</b>
2.5	AAF, ACU, AEN, AET, AEU, APL, AVT	2.5	1990.11 - 2003.04 1990.11 - 2003.04	Chassis No →70 P 250 000 Chassis No 70 R 000 001→	<b>6087.87D</b> <b>6037.87D</b>
2.5 TDI	ACV, AHY, AJT, AUF, AXG, AXL, AYC, AYY	2.5	1995.09 - 2003.04		<b>6037.87D</b>

# Thermoswitch

## VOLKSWAGEN

	Engine	Ltr.	Year	Restriction*	Thermaswitches
2.8 V6	AMV	2.8	2000.04 - 2003.04		<b>6037.87D</b>
2.8 VR 6	AES	2.8	1995.11 - 2000.04		<b>6037.87D</b>
<b>VENTO</b>					
1.4	ABD, AEX	1.4	1991.11 - 1998.09	Chassis No →1H P 990 000	<b>6017.95D</b>
			1991.11 - 1998.09	Chassis No →1H P 990 000	<b>6020.95D</b>
			1991.11 - 1998.09	Chassis No 1H R 000 001→	<b>6037.95D</b>
1.6	ABU, AEA, AEE, AEK, AFT	1.6	1992.09 - 1998.09	Chassis No →1H P 990 000	<b>6017.95D</b>
			1992.09 - 1998.09	Chassis No →1H P 990 000	<b>6020.95D</b>
			1992.09 - 1998.09	Chassis No 1H R 000 001→	<b>6037.95D</b>
1.8	AAM, ABS, ADZ	1.8	1991.11 - 1998.09	Chassis No →1H P 990 000	<b>6017.95D</b>
			1991.11 - 1998.09	Chassis No →1H P 990 000	<b>6020.95D</b>
			1991.11 - 1998.09	Chassis No 1H R 000 001→	<b>6037.95D</b>
1.9 D	1Y	1.9	1991.11 - 1998.09	Chassis No →1H P 990 000	<b>6017.95D</b>
			1991.11 - 1998.09	Chassis No →1H P 990 000	<b>6020.95D</b>
			1991.11 - 1998.09	Chassis No 1H R 000 001→	<b>6037.95D</b>
1.9 SDI	AEY	1.9	1997.04 - 1998.09		<b>6037.95D</b>
			1997.04 - 1998.09		<b>6039.95D</b>
1.9 TD	AAZ	1.9	1991.11 - 1998.09	Chassis No →1H P 990 000	<b>6017.95D</b>
			1991.11 - 1998.09	Chassis No →1H P 990 000	<b>6020.95D</b>
			1991.11 - 1998.09	Chassis No 1H R 000 001→	<b>6037.95D</b>
1.9 TDI	1Z, AFN, AHU, ALE	1.9	1996.04 - 1998.09		<b>6039.95D</b>
			1993.09 - 1998.09	Chassis No →1H P 990 000	<b>6017.95D</b>
			1993.09 - 1998.09	Chassis No →1H P 990 000	<b>6020.95D</b>
			1993.09 - 1998.09	Chassis No 1H R 000 001→	<b>6037.95D</b>
2.0	2E, ADY, AGG, AKR	2.0	1991.11 - 1998.09	Chassis No →1H P 990 000	<b>6017.95D</b>
			1991.11 - 1998.09	Chassis No →1H P 990 000	<b>6020.95D</b>
			1991.11 - 1998.09	Chassis No 1H R 000 001→	<b>6037.95D</b>
2.8 VR6	AAA	2.8	1992.01 - 1998.09	Chassis No →1H P 990 000	<b>6017.95D</b>
			1992.01 - 1998.09	Chassis No →1H P 990 000	<b>6020.95D</b>
			1992.01 - 1998.09	Chassis No 1H R 000 001→	<b>6037.95D</b>

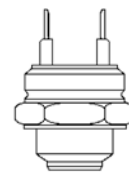

# WARTBURG

Engine

Ltr.

Year

Restriction\*

Thermaswitches

	Engine	Ltr.	Year	Restriction*	Thermaswitches
<b>353</b>					
1.0	1A, 353, 18	1.0	1966.06 - 1989.01 1975.02 - 1988.08		<b>6020.92D</b> <b>6020.95D</b>
1.3	4VO7, 2/7, 5GRF	1.3	1988.09 - 1991.05		<b>6020.95D</b>

**ZASTAVA**

Engine

Ltr.

Year

Restriction\*

Thermoswitches

**101 (1100)**

1.1	128 A.000, 128 A.064	1.1	1973.06 - 1993.12		<b>6010.95D</b>
-----	----------------------	-----	-------------------	--	-----------------

1.1 Super	128 AC 5000	1.1	1979.07 - 1981.09		<b>6010.95D</b>
-----------	-------------	-----	-------------------	--	-----------------

**YUGO**

1.1 60 EFI (145 A)	100 GL. 0.64, 11 E 1.064	1.1	1991.08 - 1995.06		<b>6010.95D</b>
--------------------	--------------------------	-----	-------------------	--	-----------------

1.3 65 EFI (145 A)	13 E 1.064	1.3	1991.08 - 1995.06		<b>6010.95D</b>
--------------------	------------	-----	-------------------	--	-----------------

**YUGO FLORIDA**

1.3 (103 A)	13 E.3.064	1.3	1991.03 -		<b>6010.95D</b>
-------------	------------	-----	-----------	--	-----------------

## Cross References

Manufacturer	Manufacturer's Ref.	Wahler-ref.	Manufacturer	Manufacturer's Ref.	Wahler-ref.
AGCO	X815.090.002.000	2391.75		077 121 113 C	4274.82D
				078 121 113 C	4274.87D
ALFA ROMEO	105.00.01.064.00	3000.83		078 121 113 F	4274.87D
	105.00.01.064.01	3000.83		078 121 113 G	4274.92D
	5177 0698	411193.82D		078 121 113 H	4274.92D
	5520 2510	410049.88D		078 121 113 J	4274.87D
	5521 5006	410871.80D ▲		191 959 481 A	6017.95D
	6050 4230	4003.86		191 959 481 B	6020.95D
	6051 6212	4160.83D		191 959 481 C	6017.95D
	6066 3619	410590.88D		1H0 959 481	6037.95D
	6071 0617	3067.83		1H0 959 481 B	6037.95D
	6071 3535	4008.79D		251 959 481	6017.95D
	6081 5681	410512.88D		251 959 481 G	6087.87D
	6081 6681	410511.88D		251 959 481 H	6087.87D
	7175 4778	410049.88D		251 959 481 K	6087.87D
	761 5234	4022.82D1		321 959 481 A	6017.95D
				321 959 481 C	6017.95D
ASTON MARTIN	52 06 139	3004.82		321 959 481 D	6017.95D
				321 959 481 E	6020.95D
AUDI	022 121 113	4455.80D		6U0 959 481 A	6017.95D
	025 121 113 D	4155.87D		811 959 481	6024.95D
	025 121 113 E	4155.87D		823 959 481	6010.92D
	025 121 113 F	4155.87D		823 959 481 A	6010.92D
	030 121 113 B	4264.84D		823 959 481 F	6010.92D
	032 121 110 B	3143.87D	823 959 481 G	6010.95D	
	032 121 110 F	3167.83D	823 959 481 L	6010.92D	
	032 121 110 L	410475.87D	867 959 481	6039.95D	
	032 121 110 P	3143.87D	893 959 481	6024.95D	
	032 121 121 G	410475.87D			
	032 121 121 K	410475.87D	AUTOBIANCHI	415 4313	3023.87D
	035 121 113	4088.80D		421 8649	3345.79
	035 121 113 B	4088.87D		426 3997	6010.95D
	036 121 113	3091.92D		4355 8460	4091.82D
	036 121 113 A	3091.92D		4409 2540	4091.82D
	036 121 113 B	3091.92D		7545 9580	3105.87D
	03G 121 111 A	4820.87D		7581 3190	3105.87D
	03G 121 113	3472.87D			
	03G 121 113 A	4820.87D	BMW	11 51 7 500 597	410793.95D
	03L 121 111 AE	410845.87D		11 53 0 139 877	4326.97D
	03L 121 111 R	410845.92D		11 53 1 247 125	410792.95D
	03L 121 111 S	410845.92D		11 53 1 251 041	4231.80D
	03L 121 113 B	410537.92D		11 53 1 253 248	3344.80
	03L 121 114 B	410536.92D		11 53 1 253 249	3344.80
	044 121 113	4264.87D		11 53 1 254 065	4231.80D
	050 121 113 C	3141.87D		11 53 1 260 720	3344.75
	052 121 113 A	3091.92D		11 53 1 264 668	4232.80D
	056 121 113 A	4256.80D		11 53 1 265 085	4232.80D
	056 121 113 D	4264.87D		11 53 1 265 086	4232.71
	059 121 113 A	4006.82D		11 53 1 312 288	4619.80
	059 121 113 B	4006.82D		11 53 1 315 063	4619.80
	068 121 113 H	4253.87D		11 53 1 318 274	4621.80D
	069 121 113	4116.87D1		11 53 1 432 881	410792.95D
	06D 121 111 G	411186.87D		11 53 1 436 042	411573.105D ▲
	06F 121 111 F	411187.87D		11 53 1 436 823	4326.97D
075 121 113 D	4123.80D		11 53 1 437 040	4326.97D	
077 121 113	4274.87D		11 53 1 437 085	411573.105D ▲	
077 121 113 B	4274.87D		11 53 1 466 174	4235.71D	

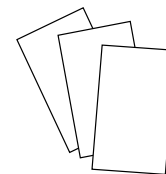

Manufacturer	Manufacturer's Ref.	Wahler-ref.	Manufacturer	Manufacturer's Ref.	Wahler-ref.
	11 53 1 485 847	410263.91D		90 411 948	4177.92D
	11 53 1 501 173	410263.91D		92 062 728	4189.87D
	11 53 1 702 279	4519.95D		92 067 408	4189.87D
	11 53 1 704 704	4594.90D		96 143 939	3017.87D2
	11 53 1 710 056	4516.85D	<b>CHRYSLER</b>	04494 469	3000.90
	11 53 1 710 953	4235.80D		04778 975	4158.80D
	11 53 1 712 043	4238.92D		0489 2642 AC	410871.80D ▲
	11 53 1 713 040	4235.80D		3156283	3000.83
	11 53 1 720 033	4516.85D		4693 117 AA	410263.91D
	11 53 1 720 306	4516.85D		4778 975	4158.80D
	11 53 1 721 002	4236.88D		5098 918 AA	4281.87D
	11 53 1 721 003	4236.88D		5202 8185 AB	3000.90
	11 53 1 727 145	4237.80D		52028185	3000.90
	11 53 1 729 720	4516.85D		5278 144 AA	410262.91D
	11 53 1 729 841	4516.85D		6801 3949 AA	4833.100D
	11 53 1 731 486	4516.70D		MD 194988	410180.82D
	11 53 1 733 803	4236.92D		T 069 7157	4147.80D
	11 53 1 739 755	410792.95D			
	11 53 1 743 528	4238.92D	<b>CITROËN</b>	1336 A7	3431.80D
	11 53 1 743 542	4238.92D		1336 AA	410075.79D ▲
	11 53 2 243 126	4237.80D		1336 N5	3463.89D
	11 53 2 244 151	4237.80D		1336 Q1	3463.89D
	11 53 2 246 199	4237.80D		1336 Q2	410184.89D
	11 53 2 246 825	4237.88D		1336 Z0	410705.89D
	11 53 7 502 779	4508.105D		1337 26	3053.75
	11 53 7 509 227	4326.97D		1338 11	3136.88D50
	11 53 7 510 959	4337.105D		1338 21	4821.89D
	11 53 7 511 083	4236.92D		1338 23	4446.83D
	11 53 7 511 580	4236.88D		1338 26	4450.89D
	11 53 7 536 655	410086.97D0		1338 38	410058.84D
	11 53 7 544 788	410086.97D0		1338 39	4450.83D
	11 53 7 549 476	410086.97D0		1338 44	3136.88D50
	11 53 7 550 172	410087.97D0		1338 71	4447.85D
	11 53 7 552 403	411574.102D ▲		1338 72	4447.80D
	11 53 7 586 885	4508.105D		1338 90	4174.82D
	11 53 7 596 787	410263.91D		1338 A0	3483.89D
	11 53 7 601 158	410766.103D0 ▲		1338 F5	3497.88D
	11 53 7 791 072	410231.82D		5454410R	3033.78D
	11 53 9 055 587	3344.80		5474546	6010.88D
	13 54 1 730 682	7129.00D ▲		5490459C	3033.78D
				75441833	3033.78D
<b>BUGATTI</b>	271990009-00	4618.70		79 100 111 01	3136.82D50
	27199003-00	4618.82		79 100 118 73	3053.75
				79 100 118 80	3136.88D50
<b>BUICK</b>	93235636	410520.92D ▲		79 100 143 90	3136.82D50
				79 100 165 60	3136.82D50
<b>CATERPILLAR</b>	4 N 6958	4256.80D		91 500 723	3061.82
	4 N 6959	4256.80D		93 501 145	4147.80D
	9 L 9119	4256.80D		93 501 386	4147.80D
	9 L 9652	4256.80D		95 492 929	3033.78D
	9 N 5020	4256.80D		95 495 311	3033.84D ▲
	9 N 5065	4256.80D		96 006 231	4821.89D
	9 N 5121	4256.80D		96 049 146	3136.88D50
	9 N 5488	4256.80D		96 050 286 80	3136.88D50
				96 057 136	3136.88D50
<b>CHEVROLET</b>	606 203 02 75	4176.85D		96 058 051	4447.85D
	9 698 4104	4431.105D		96 108 092	4450.89D



## Cross References

Manufacturer	Manufacturer's Ref.	Wahler-ref.	Manufacturer	Manufacturer's Ref.	Wahler-ref.
CITROËN	96 118 108	4447.80D	DODGE	9011 0080	410864.83D0
	96 145 00 980	410058.84D		5080 146 AB	410171.87D
	96 159 513	4147.80D		F 150.204.050.011	2391.75
	96 160 901	4446.83D		F 281.200.050.020	2389.75/1
	96 171 780 80	3136.82D50			
	96 300 66 780	3463.89D			
	96 300 666 80	3483.89D			
DACIA	77 00 101 179	126104 ▲	FIAT	83 129 996 050	4105.83D
	77 00 866 387	126104 ▲		F 150 204 050 10	2391.75
	77 00 872 554	3466.89D		F 150 204 050 11	2391.75
	82 00 374 994	411043.89D		F 281 200 050 20	2389.75/1
	82 00 400 554	411039.83D		X 815 090 002 000	2391.75
	82 00 558 758	411039.83D		X 815 090 003 000	2389.75/1
	82 00 558 783	411043.89D			
	82 00 561 420	126104 ▲		13 0707 7080	6031.88D
	82 00 660 882	3166.89D		2828 6103	6010.92D
	82 00 772 985	3466.89D		406 2141	3000.83
	82 00 954 288	411039.83D		406 2172	3000.83
	DAEWOO	110 200 03 15		4276.87D	406 5540
606 203 02 75		4176.85D	408 6415	3000.83	
90 354 822		4144.92D	411 4572	6010.92D	
90 411 948		4177.92D	413 8169	3000.83	
92 061 279		4180.82D	415 4312	3023.87D	
92 062 728		4189.87D	415 4313	3023.87D	
92 067 408		4189.87D	4218 6500	3345.79	
96 143 939		3017.87D2	422 0309	4033.82D	
			423 5333	6010.92D	
			423 5533	6010.92D	
DAF	075 0562	4619.80	424 0878	6010.92D	
	129 3885 / F75-85-95	411133.80D	426 3597	6010.92D	
	166 1375 / CF 75	411135.87D	434 0878	6010.95D	
	168 4900 / CF 75	411135.83D	435 1196	4091.82D	
	225 070	3029.83	440 9254	4091.82D	
	295 024	4619.80	443 7481	4033.82D	
	750 562	4619.80	4641 7962	410515.88D	
			4646 4992	3481.88D	
DAIHATSU	90048-33021-000	3119.88	4646 6123	4247.80D	
	90048-33029-000	4126.88	4647 7717	6035.92D	
	90048-33047	410182.84D	465 5782	4008.74D	
	90048-33056	410182.84D	4651 3506	3481.88D	
	90048-33078	410179.84D	4652 0219	6031.97D	
	90048-33083	410179.84D	4652 0785	410513.88D	
	90048-33088	410201.80D	4652 2664	3163.88D	
	90048-33092	410179.84D	4652 3118	3151.87D	
	90916-03040-000	3119.82	4652 3733	3481.88D	
	90916-03046-000	4103.82D	4652 5581	4246.80D	
	90916-03090-000	3478.82D	4653 6104	3164.88	
			4654 6375	410512.88D	
			467 4169	4008.74D	
DETROIT DIESEL	8929878	4619.86	4673 7644	3151.87D	
DEUTZ-FAHR	0117 2667	4094.71/1	4675 8586	410591.88D	
	0117 2668	4094.71/1	4677 6216	3481.88D	
	1227 0073	2393.75	4677 6217	3163.88D	
	1227 0074	2391.75	4677 6218	3164.88	
	1285 0152	4007.80D	4678 5392	410589.88D	
	1285 1663	4007.80D	4679 0294	410511.88D	
			4680 4764	410994.88D	

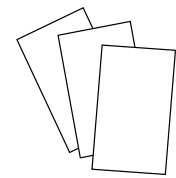

Manufacturer	Manufacturer's Ref.	Wahler-ref.	Manufacturer	Manufacturer's Ref.	Wahler-ref.
	4681 8413	3431.80D		762 5346	3431.80D
	470 3624	4008.74D		762 5347	3431.80D
	470 3625	4008.74D		762 6622	3361.87D
	475 0024	4008.79D		762 8417	3360.87D
	482 3226	4008.74D		762 8527	3355.80D
	482 6602	4151.76D		762 8799	6033.88
	5 0032 9622	4174.82D		765 5732	6035.92D
	50 415 0562	410081.79D		765 6384	3373.80D
	547 4546	6010.88D		765 6385	3373.80D
	5518 7784	410049.88D		765 6567	4022.82D1
	5519 3669	410090.88D		769 2450	3383.87
	5519 4029	410090.88D		769 6535	3383.87
	5519 4271	410048.88D		772 1399	4434.80D
	5519 9402	410588.88D		772 2107	3485.87D
	5520 2176	410090.88D		772 9959	410007.87D
	5520 2373	410048.88D		774 1883	3302.80D
	5520 2510	410049.88D		774 8867	6031.92D
	5520 3388	410049.88D		775 9596	3484.87D
	5521 5006	410871.80D ▲		777 0236	4436.80D
	5523 9819	410090.88D		777 0416	3301.80D
	592 1206	410692.71D		777 3790	410956.83D
	594 2240	3355.80D		779 1178	410516.88D
	595 0116	3159.82D		779 4132	3300.80D
	595 1985	6016.92		779 4218	410513.88D
	595 1987	6016.92		8242 0013	6031.92D
	595 8828	6033.88		8243 6410	6031.92D
	596 6787	3361.87D		8246 5533	6031.92D
	596 9749	3361.87D		8247 7919	6031.92D
	599 2746	6031.92D		907 0701	6031.92D
	6056 4101	6031.92D		9150 0723 80	3061.82
	6065 3946	410514.88D		9616 0901 80	4446.83D
	6080 8223	6031.92D		9616 0902 80	4450.83D
	6081 4382	410514.88D		9617 1780 80	3136.82D50
	708 3256	410520.92D ▲		9845 0800	3103.79
	7173 9800	4357.92D		9846 3637	4174.79D
	7174 2133	410229.82D		9849 8831	3116.82D
	7174 4389	4431.105D			
	7175 4778	410049.88D	FORD	0 801 587	4256.87D50
	7177 0832	4431.105D		1 001 993	4270.88D
	730 3174	4151.79D		1 002 788	4264.87D
	730 3615	4151.79D		1 007 754	4457.82D
	7350 2809	411193.82D		1 018 799	4123.80D
	754 0318	4022.82D1		1 031 881	4264.87D
	754 5958	3105.87D		1 032 249	4123.80D
	755 4544	3383.87		1 086 282	410131.88D ▲
	756 4583	3159.82D		1 096 283	3497.88D
	757 0837	6031.97D		1 096 699	4264.87D
	757 6281	6040.88		1 211 553	4457.82D
	758 1200	3109.87D		1 303 374	4457.82D
	758 1201	3109.87D		1 306 004	4483.82D
	758 9135	3105.87D		1 345 512	4825.98D
	7581 635	3109.82D		1 351 716	4825.98D
	759 7659	3431.80D		1 452 357	3004.88D1
	759 9824	3431.80D		1 472 378	3004.92D1
	761 3433	3378.80		1 473 089	410016.98D
	761 5234	3159.82D		1 473 090	410016.98D
	761 5235	3159.82D		1 497 689	3021.88D50

## Cross References

Manufacturer	Manufacturer's Ref.	Wahler-ref.	Manufacturer	Manufacturer's Ref.	Wahler-ref.
FORD	1 509 953	3021.88D50	GM	800 572	3021.88D50
	1 517 858	3021.88D50		800 573	3021.88D50
	1 518 627	3004.74		800 574	3021.88D50
	1 520 969	3021.88D50		81SF 8575 EA	3021.88D50
	1 607 993	3004.74		81SF 8575 FA	3021.88D50
	1 612 191	4147.80D		84FF 8575 BA	4256.87D50
	1 635 905	3021.88D50		85HF 8575 AA	3021.88D50
	1 649 194	3021.88		891F 8575 AA	3004.88D1
	1 663 819	4270.88D		89BM 8575 AC	3004.92D1
	1 712 228	4483.82D		89BM 8575 AD	3004.92D1
	3 257 449	3119.88		89FF 8575 AA	4270.88D
	3 396 924	4639.82D		89FF 8575 AB	410131.88D
	3 599 763	4639.82D		89TM 8575 AA	4270.88D
	3 893 570	4639.82D		91XM 8575 AA	3021.88D50
	3 902 514	4639.82D		928M 8575 AE	4270.88D
	4 176 181	4639.82D		948M 8575 AA	4270.88D
	4 188 498	4639.82D		95VW 8575 AB	4264.87D
	4 356 548	3100.92D ▲		95VW 8575 AC	4264.87D
	4M5G 6L721 GA	4825.98D		95VW 8B607GA	6037.95D
	4M5G 6L721 GB	4825.98D		95WM 8575 AA	3100.88D
	4M5G 8575 ZA	4483.82D		96MM 8575 A1A	4457.82D
	4M5G 8575 ZB	4483.82D		96MM 8575 BD	4457.82D
	5 004 887	3021.88D50		96MM 8575 BE	4457.82D
	5 004 890	3004.92D1		F42Z 8575 BA	4639.82D
	5 004 891	3004.92D1		KL01 15 171 A	4639.82D
	6 058 444	4256.92D50		XM34 8575 AA	4639.82D
	6 058 784	3053.75		XM34 8575 AB	4639.82D
	6 072 016	6010.95D		XS7Q 8575 AA	3497.88D
	6 077 895	6010.95D		YU3E 8575 BA	3100.92D
	6 077 896	6010.95D			
	6 077 897	6010.95D		02 898 440	3054.92D50
	6 077 898	6010.95D		02 898 688	3054.87D50
	6 077 985	6010.95D		08 966 483	4255.82D
	6 085 917	3021.88D50		08 966 485	4255.87D
	6 085 918	3021.88D50		12 615 097	411193.82D
	6 100 372	4256.87D50		12 622 410	411193.82D
	6 100 629	3021.92D50		12 992 692	4459.92D
	6 100 630	3021.88D50		21 018 811	411193.82D
	6 106 381	4256.87D50		24 405 922	4431.105D
	6 124 378	4256.87D50		24 420 652	4175.92D
	6 144 361	6010.88D		24 420 728	4297.92D
	6 153 501	4270.88D		24 435 781	4201.92D
	6 169 774	410131.88D		24 447 862	4433.92D
	6 176 366	4256.87D50		24 456 401	411578.92D ▲
	6 182 480	4147.80D		55 182 499	410588.88D
	6 201 207	3021.88D50		55 202 510	410049.88D
	6 201 247	3021.88D50		55 577 072	4431.105D
6 526 879	3004.92D1	9 108 106		4151.76D	
6 588 962	4270.88D	9 110 719		3470.89D50	
6 758 566	3100.92D	9 112 305		410517.89D	
6 866 389	4270.88D	9 128 786		4207.92D	
6 994 257	3100.88D	9 129 907		4242.92D	
691F 8575 BA	3004.92D1	9 161 123		4174.79D	
7 072 643	4158.80D	9 543 786		4193.92D	
7 215 818	6037.95D	90 009 956		4115.92D	
7S7G 6L721 AA	410016.98D	90 067 918	4255.92D		
7S7G 6L721 AB	410016.98D	90 108 636	6010.95D		

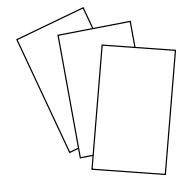

Manufacturer	Manufacturer's Ref.	Wahler-ref.	Manufacturer	Manufacturer's Ref.	Wahler-ref.
	90 156 558	4115.92D			
	90 200 836	3017.92D2	<b>HOLDER</b>	111 727	3000.83
	90 220 435	4164.92D		HD 035 A01	3000.83
	90 232 012	4144.92D			
	90 242 277	6031.100D	<b>HONDA</b>	19300-P08-014	410224.78D
	90 277 288	6031.105D		19300-PA0-003	3119.82
	90 352 677	4168.92D		19300-PB2-003	3119.82
	90 354 822	4164.92D		19300-PB2-004	3119.82
	90 357 303	6031.88D		19300-PB2-013	3119.82
	90 410 665	4144.82D		19300-PB2-014	3119.82
	90 410 897	4175.92D		19300-PB2-024	3119.82
	90 411 948	4177.92D		19300-PB2-811	3119.82
	90 412 901	4178.92D		19300-PB2-812	3119.82
	90 443 472	4164.92D		19300-PB2-815	3119.82
	90 443 473	4144.82D		19300-PB2-816	3119.82
	90 486 128	4180.82D		19300-PB2-817	3119.82
	90 501 081	4183.92D		19300-PDA-E01	410224.78D
	90 501 699	4183.82D		19300-PE0-013	4269.78D
	90 502 201	4175.92D		19300-PE0-024	4269.78D
	90 509 110	4237.80D		19300-PJ7-003	410224.78D
	90 529 846	4188.92D		19300-PJ7-004	410224.78D
	90 536 262	411578.92D ▲		19300-PLZ-004	4269.78D
	90 536 501	411578.92D ▲		19300-PM3-003	410224.78D
	90 537 453	411193.82D		19300-PM3-004	410224.78D
	90 537 605	411193.82D		19300-PR3-003	410224.78D
	90 537 811	411193.82D		19300-PT0-003	410224.78D
	90 570 620	4459.92D		19300-PT0-004	410224.78D
	90 572 899	4198.92D		19301-P07-306	410224.82D
	90 573 326	4208.92D		19301-P07-316	410224.82D
	90 573 926	4201.92D		19301-P08-000	410224.78D
	91 153 670	4158.80D		19301-P08-305	410224.78D
	91 159 950	3466.89D		19301-P08-306	410224.78D
	91 160 168	410517.83D		19301-P08-315	410224.78D
	91 160 216	126104 ▲		19301-P08-316	410224.78D
	9158251	411579.92D ▲		19301-P10-307	410224.78D
	92 063 300	4177.92D		19301-P1K-307	410224.78D
	92 063 300	4194.92D		19301-PAA-305	410224.78D
	93 177 343	410588.88D		19301-PAA-306	410224.78D
	93 179 136	410049.88D		19301-PDF-305	410224.78D
	93 181 245	411578.92D ▲		19301-PLC-305	410224.78D
	93 19 3581	410588.88D		19301-PLC-315	410224.78D
	93 198 017	410517.83D		19301-PNA-003	410225.78D
	93 198 035	411476.83D ▲		19301-PWA-305	410224.82D
	93 198 289	411476.83D ▲		19301-PZA-305	410224.82D
	93 198 317	411476.83D ▲		19301-RAF-003	410226.78D
	93 198 576	411476.83D ▲		19301-RAF-004	410226.78D
	93 198 646	411476.83D ▲		19301-REA-305	410224.78D
	93 275 736	410520.92D ▲		19301-RME-305	410224.78D
	94 372 762	3468.88D		19301-RNA-305	410224.82D
	94 580 182	410183.82D		19301-RNA-306	410224.82D
	96 610 574	410183.88D		19301-RNA-307	410224.82D
	97 087 130	3467.85D		19301-RP3-305	410224.78D
	97 094 283	3004.82			
			<b>HYUNDAI</b>	25500-22600	410351.88D
<b>HAKO</b>	69015347	4264.87D		25500-23001	410348.82D
<b>HOLDEN</b>	92 063 300	4177.92D		25511-29000	4446.83D

## Cross References

Manufacturer	Manufacturer's Ref.	Wahler-ref.	Manufacturer	Manufacturer's Ref.	Wahler-ref.	
INNOCENTI	34 402 115	3004.82	JAGUAR	9843 2310	4166.79D	
	65 540 40601	3044.80		9843 3497	4165.79D	
INTER. HARV. IHC	3059 676 R 1	4017.82		9846 3637	4174.79D	
	3059 676 R 91	4017.82		9846 7516	4166.79D	
	3059 676 R 92	4017.82		9846 7517	4163.79D	
	3228 046 R 2	4017.82		9849 2868	4163.74D	
	3228 046 R1	4017.82		9849 2873	4163.74D	
	84247900	6010.75D		9849 8322	4622.82D0	
				9849 8322 Kit	410763.82D	
ISUZU	5-86000-349-0	410224.78D		9943 1512	4619.86	
	5-86000-350-0	410224.78D		JAGUAR	C28067	4006.82D
	5-86008138	410224.82D			C33012	4006.82D
	5-86012-056	410224.78D			C37129	4006.82D
	5-86014-381-0	410224.78D		JEEP	04494469	3000.90
	5-86018-963	410224.78D			5175583AB	4630.87D ▲
	5-86018-964-0	410224.78D			52028185AB	3000.90
	5-86019-507-0	410224.78D		T 069 7157	4147.80D	
	5-86019-513-0	410224.78D		JOHN DEERE	AT 22961	3000.83
	8-79312-726-0	3467.85D			AT 22963	3000.90
	8-94123-295-0	3468.88D			RE 33705	3000.90
	8-94123-295-1	3468.88D	KIA	OK2A-15-171	410352.82D	
	8-94360-227-0	3467.85D		OK2C0-15-171A	410352.88D	
	8-94372-762-0	3468.88D		OK710-15-171	3498.88D	
	8-97087-130-2	3467.85D		OK9FC-15-171	3498.88D	
	94 207 217	3004.82		KE5D3-15-171	3498.88D	
	94 214 962	4022.82D		KHE41-15-171	410352.82D	
		KOMATSU		2871 591 M	4520.80D	
			2872 578 M	4530.80		
IVECO	413 8769	3000.83	LADA	21080-13060-10	3333.87	
	468 4390	4008.79D		2108-13060-10	3333.87	
	470 3088	4008.79D		21081-3060-11	3333.87	
	471 6264	4152.79D		21215-13060-15	4446.83D	
	473 8169	4165.79D		LANCIA	4652 0785	410513.88D
	474 9724	4105.75D			4652 2664	3163.88D
	477 0246	4174.79D			4654 6375	410512.88D
	480 4321	4166.79D	4679 0294		410511.88D	
	480 7492	4152.79D	599 9818		3431.80D	
	482 3211	4174.79D	754 0318		4022.82D1	
	483 1783	4152.79D	758 1201		3109.82D	
	483 7166	4174.79D	758 1636	3109.82D		
	50 032 9622	4174.82D	758 9135	3105.87D		
	50 401 7209	3171.82D	779 4218	410513.88D		
	50 404 5799	3169.79D	7910247116	4122.87D		
	50 408 4365	3169.79D	8234 2688	3356.80D		
	50 409 6443	4619.86	9616 0901 80	4446.83D		
	50 409 6443 Kit	410608.86D	LANDROVER	GTS 303	4147.80D	
	50 413 2246	410075.79D ▲		RTC 6673	4158.80D	
	50 415 0562	410081.79D		LEXUS	90916-03079	411545.82D ▲
	50 425 8346	410289.81D			90916-03081	411545.82D ▲
	50 432 0545	410289.81D				
	50 438 7382	410937.82D ▲				
	6131 6592	4162.79D				
	6131 8373	4162.79D				
	730 3615	4151.79D				
	809 6735	4174.79D				
	9842 0718	4163.79D				
	9842 4854	4165.79D				

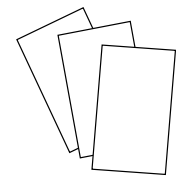

Manufacturer	Manufacturer's Ref.	Wahler-ref.	Manufacturer	Manufacturer's Ref.	Wahler-ref.	
LIEBHERR	90916-03144	4480.82D		8173-99-152 A	3499.88D	
	90916-03145	4480.82D		8173-99-152 B	3119.88D3	
				8173-99-152 B	3499.88D	
	738 0513	4530.80		8AB1-15-171	3498.88D	
LOMBARDINI	738 0833	4083.79 ▲		8AB3 15 171	4006.82D	
				8AB5-15-171	3498.88D	
	1000208309	4007.80D		8AB7-15-171	3499.82D	
	104 9195 092	4008.79D		8AB8-15-171	3498.88D	
	9195 057	4007.80D		8AB9-15-171	3499.82D	
	9195 1240	4007.80D		8ABA-15-171	3499.88D	
	ED0091951240S	4007.80D		8ABB-15-171	3499.88D	
				8ABB-15-171A	3499.88D	
MACK	657 GC 324 A-P80	411045.82D		8ABC-15-171	3499.82D	
		8ABD-15-171		3499.88D		
MAN	51.06402.0034	4150.79D50		8ABE-15-171	3498.88D	
	51.06402.0042	4150.71D50		8AG1-15-171	3468.88D	
	51.06402.0043	4150.79D50		8AG1-15-171A	3468.88D	
	51.06402.0044	4150.79D50		8AG2-15-171	3468.88D	
	51.06402.0049	4150.79D50		8AG2-15-171A	3468.88D	
	51.06402.0050	4150.79D50		8AG3-15-171	3498.88D	
	51.06402.0051	4150.79D50		8AG4-15-171	3119.88D3	
	51.06402.0052	4150.71D50		8AG4-15-171	3499.88D	
	51.06402.0053	4150.79D50		8AG5-15-171	3498.88D	
	51.06402.0056	4150.79D50		8AG6-15-171	3468.88D	
	51.06402.0057	4150.71D50		8AG7-15-171	3468.88D	
	51.06402.0058	4150.83D50		8AG8-15-171	3468.88D	
	51.06402.0060	4150.83D50		8AGX-15-171	4639.82D	
	51.06402.0061	4150.79D50		8AK1-15-171	3498.88D	
	51.06402.0062	4150.71D50		8AN1-15-171	3498.88D	
	51.06402.0063	4150.83D50		8AU1-15-171	3498.88D	
	51.06402.0064	4150.79D50		8AU-15-171	3498.88D	
	51.06402.0065	4150.71D50		8AX1-15-171	3119.88D3	
	51.06402.0066	4150.83D50		8AX1-15-171	3499.88D	
	51.06402.0067	4150.79D50		8AZ1-15-171	3468.88D	
	51.06402.0068	4150.71D50		AB6-15-171	3498.88D	
	51.06402.0069	4150.79D50		B366-15-171	3499.82D	
	81.06401.0019	410864.71D0		B3H3-15-171	3499.82D	
	81.06401.0037	410864.79D0		B3H8-15-171A	3499.82D	
	81.06401.0038	410864.83D0		B541-15-171	3119.88D3	
81.06401.0042	410864.71D0	B541-15-171	3499.88D			
81.06401.0045	410864.83D0	B6H-15-171	3498.88D			
81.06401.0046	410864.79D0	B6H-15-171 A	3498.88D			
81.06401.6002	4373.70 ▲	BP6F-15-171	3498.88D			
MAZDA				BPD3-15-171	3498.88D	
	0223-15-171	3499.82D		E5D3-15-171	3498.88D	
	0419-15-171	3499.82D		F201-15-171	3498.88D	
	0419-99-152	3499.82D		FS05-15-171	4639.82D	
	1A51-15-171	4639.82D		HE 41-99-152 A	3119.88D3	
	1E03-15-171	3004.92D1		HE 41-99-152 C	3119.82D3	
	1E05-15-171 A	4457.82D		HE 41-99-152C	3499.82D	
	1E07-15-171	410131.88D		HE 41-99-152D	3499.82D	
	1E07-15-171 A	410131.88D		KL01-15-171	4639.82D	
	8124-99-152	3119.82		KL01-15-171 A	4639.82D	
	8173-15-152 C	3499.88D		RF03-15-171A	3468.88D	
	8173-15-171	3499.88D		ZZ40-15-171	3498.88D	
	8173-99-152	3499.88D				
	8173-99-152 A	3119.88D3				
				MERCEDES-BENZ	000 203 64 75	3000.80

## Cross References

Manufacturer	Manufacturer's Ref.	Wahler-ref.	Manufacturer	Manufacturer's Ref.	Wahler-ref.
MERCEDES-BENZ	001 203 58 75	3000.80		005 203 59 75	4472.83D
	001 203 69 75	4083.83D50		100 200 05 15	4078.87D
	001 203 90 75	4078.79D		100 200 07 15	4078.79D
	001 203 91 75	4078.87D		102 200 08 15	4078.87D
	002 203 04 75	4083.83D50		102 200 14 15	4078.87D
	002 203 16 75	4078.71D		102 200 15 15	4078.87D
	002 203 31 75	4078.71D		102 200 19 15	4078.87D
	002 203 32 75	4105.83D		110 200 01 11	4078.87D
	002 203 35 75	4078.79D		110 200 05 15	4078.87D
	002 203 37 75	4078.79D		110 200 09 15	4078.71D
	002 203 38 75	4078.79D		110 200 19 15	4078.92D
	002 203 39 75	4105.71D		111 200 03 15	4276.87D
	002 203 45 75	4105.83D		111 200 08 15	4279.87D
	002 203 46 75	4078.79D		111 200 09 15	4275.87D
	002 203 47 75	4105.83D		111 200 17 15	4414.87D
	002 203 49 75	4105.83D		111 203 02 75	4275.87D
	002 203 53 75	4083.83D50		111 203 03 75	4276.87D
	002 203 56 75	4105.83D		111 203 05 75	4279.87D
	002 203 59 75	4105.83D		111 203 06 75	4275.87D
	002 203 72 75	4078.79D		111 203 08 75	4275.87D
	002 203 75 75	4117.80D		111 203 10 75	4414.87D
	002 203 76 75	4078.87D		112 200 00 15	4281.87D
	002 203 78 75	4078.79D		112 200 01 15	4298.87D
	002 203 79 75	4105.83D		112 203 02 75	4281.87D
	002 203 80 75	4117.80D		112 203 03 75	4298.87D
	002 203 81 75	4078.87D		116 200 00 15	4064.75D
	002 203 82 75	4064.75D		116 200 02 15	4233.84D
	002 203 90 75	4105.83D		116 200 03 15	4137.80D
	003 203 14 75	4105.83D		119 200 00 15	4278.80D
	003 203 22 75	3000.80		119 203 01 75	4278.80D
	003 203 28 75	4105.83D		120 200 00 15	4517.87D
	003 203 29 75	4105.71D		120 203 02 75	4517.87D
	003 203 31 75	4105.83D		160 200 03 15	3142.90D
	003 203 32 75	4105.71D		166 203 00 75	411576.87D ▲
	003 203 73 75	4105.83D		166 203 01 75	411576.87D ▲
	003 203 74 75	4105.71D		166 203 02 75	411576.87D ▲
	003 203 78 75	4105.83D		266 203 02 75	411577.80D ▲
	003 203 79 75	4105.71D		266 203 04 75	411577.80D ▲
	003 203 82 75	4233.84D		266 203 06 75	411577.80D ▲
	003 203 91 75	4105.79D		271 200 00 15	3457.90D
	003 203 92 75	4105.79D		271 200 01 15	410389.103D ▲
	003 203 98 75	4176.80D		271 200 02 15	410389.103D ▲
	004 203 09 75	4176.85D		271 200 03 15	410389.103D ▲
	004 203 39 75	4137.80D		271 203 03 75	3457.90D
	004 203 40 75	4137.80D		272 200 00 15	4834.100D
	004 203 65 75	4078.65D		272 200 01 15	4834.100D
	004 203 83 75	4105.83D		272 200 04 15	4834.100D
	004 203 84 75	4105.71D		272 200 05 15	4833.100D
	004 203 85 75	4105.79D		272 200 06 15	4829.100D ▲
	004 203 86 75	4078.92D		273 200 01 15	4829.100D ▲
005 203 17 75	4619.75		273 200 02 15	4833.100D	
005 203 18 75	4619.80		273 200 04 15	4829.100D ▲	
005 203 19 75	4619.86		373 203 70 75	4105.83D	
005 203 26 75	4105.83D		601 200 00 15	4176.85D	
005 203 27 75	4105.79D		601 200 01 15	4176.80D	
005 203 28 75	4105.71D		602 200 00 15	4176.80D	
005 203 29 75	4123.80D		603 200 00 15	4176.80D	

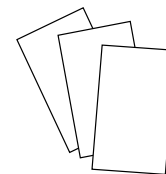

Manufacturer	Manufacturer's Ref.	Wahler-ref.	Manufacturer	Manufacturer's Ref.	Wahler-ref.
	603 203 04 74	4280.80D		MD 345617	4637.76D
	603 203 04 74	4280.85D		MD 348937	410180.82D
	604 203 00 75	4280.85D		MD 351495	410180.82D
	605 203 00 75	4280.80D		MD 360320	4637.82D
	606 203 01 75	4176.80D		MD 972903	3119.88D4
	606 203 02 75	4176.85D		MD 972905	3119.82D4
	606 203 05 75	4176.85D		MD 972908	3119.82D4
	607 200 00 15	3004.82		MD 997217	3119.82D4
	611 200 02 15	410171.87D		MD 997219	3119.82D4
	611 200 07 15	410171.87D		MD 997220	3119.82D4
	611 203 04 75	410171.87D		MD 997221	3119.88
	611 203 05 75	410171.87D		MD 997221	3119.88D4
	611 203 15 75	410171.87D		MD 997224	4638.82D
	611 203 19 75	410171.87D		MD 997461	3119.88D4
	615 200 13 15	4117.80D		MD 997602	3119.82D4
	616 200 04 15	4117.80D		MD 997603	3119.82D4
	617 200 03 15	4049.80D		MD 997605	4638.76D
	617 200 11 15	4049.80D		MD 997606	4638.82D
	617 200 18 15	4049.80D1		MD 997607	3119.82D4
	628 203 01 75	4309.92D		MD 997608	3119.88D4
	642 200 02 15	4490.87D		MD 997644	410180.82D
	642 200 02 15	4835.87D		ME 190303	4637.76D
	642 200 03 15	4630.87D ▲		ME 191593	4637.76D
	642 200 04 15	4835.87D		ME 200262	4637.76D
	642 200 07 15	4832.87D ▲		ME 220538	410180.82D
	642 200 08 15	410055.87D ▲		ME 241816	410180.82D
	642 200 20 15	4490.87D		ME 999295	4638.82D
	646 200 00 15	410174.92D		MN 980137	3472.87D
	646 200 11 15	410174.92D			
	646 200 12 15	410171.87D		<b>MULTICAR</b>	0820117806
646 203 02 75	410174.92D		4008540	4264.87D	
660 200 03 15	3146.90D				
<b>MITSUBISHI</b>	M-474877	3470.89D50	<b>MWM</b>	1215 2752	2391.75
	M-863985	3470.89D50		1215 2766	2391.75
	MD 001370	3119.82D4		6 052 5 010 005 0	4520.75
	MD 005131	3119.88D4		6 052 5 011 001 1	2391.75
	MD 005371	3119.82D4		6 052 5 011 002 4	2393.75
	MD 008086	3119.82D4		6 052 5 011 004 2	2391.75
	MD 015299	4638.82D		6 052 5 100 41	2393.75
	MD 075460	3119.82D4		9 225 0 757 014 6	4351.79
	MD 094120	4638.82D		9 229 8 757 004 6	4588.75/1
	MD 117759	3119.82D4		9 407 0 757 002 4	3145.79D
	MD 126168	3119.82D4	<b>NEOPLAN</b>	0303.191.04	4520.80D
	MD 158570	4637.82D			
	MD 164541	4637.76D	<b>NISSAN</b>	11060-00Q0C	411475.89D ▲
	MD 165630	4637.82D		11060-00Q0E	411475.89D ▲
	MD 170031	4637.76D		11060-00Q0K	411442.83D ▲
	MD 174233	410180.82D		11060-00Q0S	411442.83D ▲
	MD 175746	4637.82D		11060-00QAF	410538.89D
	MD 194988	410180.82D		11060-00QAJ	411040.83D
	MD 310106	4637.82D		11060-00QAL	411475.89D ▲
	MD 315301	4637.82D		11060-AW300	410517.89D
	MD 317015	4637.76D		11060-BN700	411043.89D
	MD 335170	4637.82D		11061-00Q0A	411476.83D ▲
	MD 337408	4637.82D		11061-00Q0B	411476.83D ▲
	MD 338234	4637.82D		11061-00Q0D	411039.83D



## Cross References

Manufacturer	Manufacturer's Ref.	Wahler-ref.	Manufacturer	Manufacturer's Ref.	Wahler-ref.
NISSAN	11061-00Q0E	411043.89D		13 38 003	4242.92D
	11061-00Q0G	411476.83D ▲		13 38 007	411193.82D
	11061-00Q0K	411476.83D ▲		13 38 008	411193.82D
	11061-00Q0L	411476.83D ▲		13 38 009	4201.92D
	11061-00Q1B	411476.83D ▲		13 38 015	4297.92D
	11061-00QAB	410517.83D		13 38 015 old number	3017.92D50
	11061-00QAC	410517.83D		13 38 016	3054.92D50
	11061-00QAD	410517.89D		13 38 017	4433.92D
	11061-00QAE	3166.89D		13 38 018	3054.87D50
	11061-00QAG	411043.89D		13 38 020	410048.88D
	11061-00QAL	411043.89D		13 38 024	4255.82D
	11061-00QAM	411039.83D		13 38 030	3004.82
	21200-01B00	3044.90D1		13 38 033	4255.87D
	21200-2H600	3118.82D1		13 38 034	411193.82D
	21200-2H605	3118.88D1		13 38 038	4255.92D
	21200-41B00	3118.82D1		13 38 039	410049.88D
	21200-4M500	3478.82D		13 38 041	3054.87D50
	21200-57J00	410176.82D0		13 38 042	3021.88D50
	21200-57J05	410176.88D0		13 38 046	4115.92D
	21200-57J15	410176.82D0		13 38 049	4144.92D
	21200-6F900	4821.89D		13 38 050	4164.92D
	21200-6F901	4821.89D		13 38 052	3017.92D2
	21200-77A00	4634.76		13 38 054	4144.92D
	21200-77A05	3478.82D		13 38 056	3468.88D
	21200-77A60	4634.76		13 38 057	4164.92D
	21200-77A61	4634.76		13 38 059	4144.82D
	21200-77A63	4634.76		13 38 060	4168.92D
	21200-77A65	3478.82D		13 38 062	4144.82D
	21200-77A66	3478.82D		13 38 063	4164.92D
	21200-78515	3118.88D1		13 38 067	4175.92D
	21200-85G00	3118.82D1		13 38 068	4177.92D
	21200-85G05	3118.88D1		13 38 069	4180.82D
	21200-85G06	3118.88D1		13 38 073	4178.92D
	21200-86J00	3478.82D		13 38 075	3467.85D
	21200-86J01	3478.82D		13 38 076	4237.80D
	21200-90J00	3478.82D		13 38 077	3004.82
	21200-90J10	3478.82D		13 38 079	4183.92D
	21200-99B03	3118.82D1		13 38 080	4183.82D
	21200-9F600	3478.82D		13 38 084	4175.92D
	21200-BX000	410488.88D		13 38 087	4188.92D
	21200-ED000	411241.82D		13 38 096	4459.92D
	21200-ED00A	411241.82D		13 38 097	4201.92D
	21200-G3100	3000.83		13 38 100	4198.92D
	21200-P7500	3118.88D1		13 38 154	410049.88D
	21200-P7901	3118.82D1		13 38 178	4431.105D
	21200-P7905	3118.88D1		13 38 275	410049.88D
	21200-P7906	3118.88D1		13 38 331	4208.92D
	21200-P7990	3118.82D1		13 38 427	411193.82D
	21200-P7991	3118.88D1		13 38 466	4158.80D
	21200-V0100	3118.82D1		13 38 478	4194.92D
21200-V0105	3118.88D1		13 41 002	6010.95D	
21200-V0200	3118.82D1		13 41 011	6031.100D	
21200-V0201	3118.82D1		13 41 017	6031.105D	
21200-V0205	3118.88D1		13 41 028	6031.88D	
21200-V0206	3118.88D1		1338 001	411578.92D ▲	
			1338 004	411579.92D ▲	
			1338 098	411578.92D ▲	
OPEL	13 38 002	4207.92D			

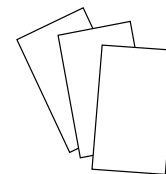

Manufacturer	Manufacturer's Ref.	Wahler-ref.	Manufacturer	Manufacturer's Ref.	Wahler-ref.
	44 00 106	4151.76D		1338 13	4447.85D
	44 02 719	3470.89D50		1338 19	4447.80D
	44 04 305	410517.89D		1338 20	4147.80D
	44 08 334	3466.89D		1338 21	4821.89D
	44 08 928	410517.83D		1338 23	4446.83D
	44 09 180	126104 ▲		1338 25	4147.80D
	44 32 983	410517.83D		1338 26	4450.89D
	44 33 121	411476.83D ▲		1338 37	3136.82D50
	44 34 144	411476.83D ▲		1338 38	410058.84D
	44 34 190	411476.83D ▲		1338 39	4450.83D
	44 49 134	411476.83D ▲		1338 44	3136.88D50
	44 49 506	411476.83D ▲		1338 71	4447.85D
	45 00 823	4174.79D		1338 72	4447.80D
	47 08 757	410588.88D		1338 83	3136.82D50
	48 11 586	4189.87D		1338 90	4174.82D
	63 38 004	4428.92D		1338 A0	3483.89D
	63 38 018	4431.105D		1338 C8	4821.89D
	63 38 022	410588.88D		1338 F5	3497.88D
	63 38 028	4459.92D		5474546	6010.88D
	63 38 039	410048.88D		79 100 118 73	3053.75
	63 38 050	4357.92D		79 102 461 13	4122.87D
	6338 005	411578.92D ▲		79 102 471 16	4122.87D
	6338 035	411578.92D ▲		91 500 723 80	3061.82
	93 18 4200	410048.88D		91 500 724 80	3061.88
				96 057 087 80	3136.88D50
<b>PACCAR</b>	129 3885 / F75-85-95	411133.80D		96 057 136 80	3136.88D50
	166 1375 / CF 75	411135.87D		96 090 230 80	4147.80D
	168 4900 / CF 75	411135.83D		96 108 092 80	4450.89D
				96 108 093 80	4450.89D
<b>PEGASO</b>	222730	4619.75		96 160 902 80	4450.83D
	770275	4078.75D		96 196 379 80	3136.88D50
	770662	4619.75		96 272 785 80	4447.80D
				96 272 814 80	4447.85D
<b>PERKINS</b>	7483490	3000.75		96 300 666 80	3483.89D
	PF 52.842	3000.80		96 300 667 80	3463.89D
				96 472 659 80	410705.89D
<b>PEUGEOT</b>	1264 32	6031.92D		96á485 426 80	410184.89D
	1264 33	6035.92D			
	1264 50	6031.88D	<b>PORSCHE</b>	928.106.129.06	4161.83
	1264 50	6031.92D		928.106.129.16	4161.83
	1336 A7	3431.80D		928.106.129.17	4161.83
	1336 AA	410075.79D ▲		944.106.019.00	4256.83D60
	1336 N5	3463.89D		944.106.129.05	4256.80D60
	1336 Q1	3463.89D		944.106.129.05	4256.83D60
	1336 Q2	410184.89D		944.606.481.00	6010.92D
	1336 Z0	410705.89D		955.106.113.00	4455.80D
	1337 26	3053.75		996.106.013.54	4249.83D
	1337 27	3136.88D50		996.106.013.55	4249.83D
	1337 30	3136.82D50		996.106.013.56	4249.83D
	1337 34	4122.87D		996.106.013.57	4249.83D
	1337 47	3061.82		996.106.121.53	4249.83D
	1337 48	3159.82D		996.106.125.52	4249.83D
	1337 49	3061.88			
	1337 64	4147.80D	<b>RENAULT</b>	00 24 774 033	4529.70
	1337 65	3033.84D ▲		11 06 023 09R	411477.89D ▲
	1337 68	4147.80D		11 06 030 26R	411442.83D ▲
	1338 11	3136.88D50		11 06 055 36R	411442.83D ▲

## Cross References

Manufacturer	Manufacturer's Ref.	Wahler-ref.	Manufacturer	Manufacturer's Ref.	Wahler-ref.
RENAULT	50 00 684 865	410828.82D0		77 01 348 373	3470.89D50
	50 00 684 865 Kit	410828.82D		77 01 348 374	3029.86
	50 00 691 267	410828.86D0		77 01 348 376	3029.83
	50 00 691 267 Kit	410828.86D		77 01 349 173	4122.87D
	50 00 694 785	4529.83D0		77 01 349 415	4122.87D
	50 00 816 924	4151.76D		77 01 474 248	410518.89D
	50 01 855 520	4619.82		77 01 474 249	410530.89D
	50 10 284 184	411045.82D		82 00 039 885	411043.89D
	50 10 295 225	4596.83D		82 00 074 346	410517.89D
	50 10 295 225 2x Kit	410758.83D		82 00 074 349	410517.83D
	50 10 447 161	4619.86		82 00 112 054	410538.89D
	50 10 553 100	4619.86		82 00 171 021	411043.89D
	60 01 543 366	3466.89D		82 00 244 023	411039.83D
	60 05 000 004	2391.75		82 00 244 402	411043.89D
	60 05 004 616	2391.75		82 00 248 531	411477.89D ▲
	60 05 004 616	2393.75		82 00 267 349	411042.89D
	74 31 397 947	4272.90D		82 00 374 994	411043.89D
	74 36 842 409	4272.90D		82 00 380 898	411475.89D ▲
	74 39 180 811	4272.90D		82 00 400 553	411040.83D
	77 00 024 756	2389.75/1		82 00 400 554	411039.83D
	77 00 024 756	2391.75		82 00 403 437	411476.83D ▲
	77 00 101 179	126104 ▲		82 00 558 751	411040.83D
	77 00 109 641	410530.89D		82 00 558 758	411039.83D
	77 00 110 716	3166.89D		82 00 558 766	411042.89D
	77 00 112 491	410518.89D		82 00 558 779	411477.89D ▲
	77 00 260 959	4449.84D		82 00 558 783	411043.89D
	77 00 575 874	3029.83		82 00 561 420	126104 ▲
	77 00 619 931	3029.86		82 00 656 419	411475.89D ▲
	77 00 657 955	4122.87D		82 00 656 420	411475.89D ▲
	77 00 665 226	4147.80D		82 00 660 882	3166.89D
	77 00 697 157	4147.80D		82 00 674 368	410517.89D
	77 00 703 136	4122.87D		82 00 674 369	410517.83D
	77 00 710 657	4122.87D		82 00 699 392	411475.89D ▲
	77 00 722 762	3029.86		82 00 703 139	411475.89D ▲
	77 00 723 945	3470.89D50		82 00 703 140	411476.83D ▲
	77 00 727 190	3029.89		82 00 772 985	3466.89D
	77 00 730 540	3029.89		82 00 801 567	411476.83D ▲
	77 00 742 617	3469.91D		82 00 801 570	411475.89D ▲
	77 00 858 087	4147.80D		82 00 801 571	411475.89D ▲
	77 00 858 802	3469.91D		82 00 907 229	411475.89D ▲
	77 00 862 200	4147.80D		82 00 907 234	411475.89D ▲
	77 00 866 387	126104 ▲		82 00 907 239	411476.83D ▲
	77 00 866 896	3470.89D50		82 00 907 243	411476.83D ▲
	77 00 868 274	4446.83D		82 00 954 285	411043.89D
	77 00 868 980	3174.89D		82 00 954 288	411039.83D
	77 00 872 314	3470.89D50		82 00 954 289	411481.89D ▲
	77 00 872 554	3466.89D		82 00 954 328	411442.83D ▲
77 00 872 635	3466.89D				
77 01 026 647	4008.79D	ROLLS-ROYCE	11 53 7 586 885	4508.105D	
77 01 035 736	3116.82D				
77 01 038 494	4446.83D	ROVER	GTS 282	3000.83	
77 01 039 156	3116.82D		GTS 287	4158.80D	
77 01 042 512	4174.79D		GTS 298	3000.90	
77 01 068 770	411241.82D		GTS 299	4821.89D	
77 01 348 068	3029.89		GTS 301	410808.88D	
77 01 348 139	3053.85		PEL 000170	410806.88D	
77 01 348 372	3136.82D50		PEL 10009 EVA	4158.80D	

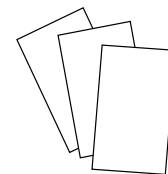

Manufacturer	Manufacturer's Ref.	Wahler-ref.	Manufacturer	Manufacturer's Ref.	Wahler-ref.	
SAAB	PEL 10016	410808.88D		032 121 110 L	410475.87D	
	PEL 10019 EVA	4821.89D		032 121 110 P	3143.87D	
				032 121 121 G	410475.87D	
	12 61 5097	411193.82D		032 121 121 K	410475.87D	
	12 62 2410	411193.82D		03G 121 111 A	4820.87D	
	24 435 102	4357.92D		03G 121 113	3472.87D	
	30 57 7561	4154.88D		03G 121 113 A	4820.87D	
	45 03 017	4175.92D		03L 121 111 AE	410845.87D	
	46 23 815	4175.92D		03L 121 111 R	410845.92D	
	47 72 190	4193.92D		03L 121 111 S	410845.92D	
	55 20 3388	410049.88D		03L 121 113 B	410537.92D	
	640972	411578.92D ▲		03L 121 114 B	410536.92D	
	75 02 297	4022.82D		044 121 113	4264.87D	
	75 17 345	4154.82D		050 121 113 C	3141.87D	
	83 89 512	4022.88D		056 121 113 D	4264.87D	
	85 47 572	6010.88D		068 121 113 H	4253.87D	
	85 69 23	6010.92D		06D 121 111 G	411186.87D	
	88 17 298	4154.88D		06F 121 111 F	411187.87D	
	88 17 538	4154.82D		075 121 113 D	4123.80D	
	88 22 025	4154.88D		191 959 481 A	6017.95D	
	90 53 7453	411193.82D		191 959 481 B	6020.95D	
	90 53 7811	411193.82D		191 959 481 C	6017.95D	
	91 66 687	4154.88D		1H0 959 481	6037.95D	
	91 94 101	4154.88D		1H0 959 481 B	6037.95D	
	91 94 242	4154.88D		251 959 481	6017.95D	
	93 20 284	4022.92D		321 959 481 A	6017.95D	
	93 37 551	4022.82D		321 959 481 C	6017.95D	
	95 26 518	6010.95D		321 959 481 D	6017.95D	
	SAURER	154.0943.426		4530.80	6U0 959 481 A	6017.95D
		461.0943		4030.70	823 959 481	6010.92D
					823 959 481 A	6010.92D
	SCANIA	1 347 594		4224.80D	823 959 481 F	6010.92D
		1 358 995		4223.83D	823 959 481 G	6010.95D
1 395 856		4520.75	823 959 481 L	6010.92D		
1 404 924		4223.83D	867 959 481	6039.95D		
1 404 925		4224.80D	CA 032.221.01	3000.83		
1 423 450		4223.83D	EA03222101	3023.87D		
1 423 451		411004.80D	SE 020 032 221 A	3361.87D		
1 431 979		4223.75D	SE 021 032 221 B	4256.87D50		
1 458 198		4224.75D	SE 021 952 600 A	6020.92D		
1 745 449		4224.80D				
1 799 757		411004.80D	SKODA	032 121 110 B	3143.87D	
1 800 909		411004.80D		032 121 110 B	410989.87D	
1 849 060		411004.80D		032 121 110 F	3167.83D	
2 832 814		4520.80D		032 121 110 J	410989.87D	
238 156		3096.75		032 121 110 L	410475.87D	
283 281		4520.80D		032 121 110 P	3143.87D	
525 076		3096.75		032 121 113	4253.87D	
550 275		4520.80D		032 121 121 G	410475.87D	
				032 121 121 K	410475.87D	
SEAT		0004218650		3345.79	03G 121 111 A	4820.87D
	030 121 113 B	4264.84D		03G 121 113	3472.87D	
	032 121 110 B	3143.87D		03G 121 113 A	4820.87D	
	032 121 110 B	410989.87D		03L 121 111 AE	410845.87D	
	032 121 110 F	3167.83D		03L 121 111 R	410845.92D	
	032 121 110 J	410989.87D		03L 121 111 S	410845.92D	
				03L 121 113 B	410537.92D	

## Cross References

Manufacturer	Manufacturer's Ref.	Wahler-ref.	Manufacturer	Manufacturer's Ref.	Wahler-ref.
SKODA	03L 121 114 B	410536.92D	SUZUKI	21210-AA120	411716.88D ▲
	044 121 113	4264.87D		21210-AA140	411715.84D ▲
	050 121 113 C	3141.87D		21210-AA150	411716.88D ▲
	056 121 113	4253.87D		21210-AA160	411715.84D ▲
	056 121 113 D	4264.87D		31753-0100	3000.83
	068 121 113 H	4253.87D			
	06D 121 111 G	411186.87D		17570-74000	410228.82D
	06F 121 111 F	411187.87D		17570-740001	410228.82D
	077 121 113	4274.87D		17570-86CA0	4446.83D
	077 121 113 B	4274.87D		17600-77820	410183.88D
	078 121 113	4274.87D		17600-83810	410228.82D
	078 121 113 C	4274.87D		17600-83811	410228.82D
	078 121 113 F	4274.87D		17600-83820	410228.82D
	078 121 113 J	4274.87D		17600-83821	410228.82D
	113 095 0	3032.80		17600-83821-000	3119.82
	113 095 075	6010.75D		17600-83822	410228.82D
	113 095 090	6010.92D		17600-83823	410228.82D
	113 095 091	3032.80		17600-85811	410183.82D
	114 095 090	3032.88		17600-85821	410183.88D
	115 095 070	6010.88D		17600-85830	410228.82D
	1H0 959 481 B	6037.95D		17600-85831	410228.82D
	441 044 330 186	6017.95D		17670-50G00	410183.82D
	823 959 481 G	6010.95D		17670-50G10	410183.88D
	823 959 481 H	6010.95D		17670-50G20	410183.88D
	823 959 481 K	6010.95D		17670-63J00	410229.82D
867 959 481	6039.95D	17670-65D00	410229.82D		
		17670-66G00	4446.83D		
SMART	0003179V009	3142.90D	17670-67H00	410183.88D	
	0003179V010	3142.90D	17670-73000	410228.82D	
	0004698V002	3146.90D	17670-73020	410228.82D	
	0004698V003	3146.90D	17670-73021	410228.82D	
	660 200 05 15	3146.90D	17670-76A00	410183.82D	
	Q0003179V010000000	3142.90D	17670-76A01	410183.82D	
			17670-76G00	410183.82D	
STEYR	217.87.71	6010.75D	17670-76G10	410183.88D	
	311.00.06.0065	4368.87	17670-77E00	410229.82D	
	609E060013	4520.80D	17670-77E10	4639.82D	
		17670-77E11	4639.82D		
SUBARU	21200-AA071	410230.78D	17670-77G00	410183.82D	
	21200-AA072	410230.78D	17670-77G10	410183.88D	
	21200-AA140	411715.84D ▲	17670-78E00	3468.88D	
	21200-AA150	411716.88D ▲	17670-82810-000	410183.82D	
	21200-AA160	411715.84D ▲	17670-83000	410228.82D	
	21200-AA170	411743.82D ▲	17670-83001	410228.82D	
	21200-AA200	411716.88D ▲	17670-83010	410228.82D	
	21200-AA220	411715.84D ▲	17670-83011	410228.82D	
	21200-AA230	411715.84D ▲	17670-85020	410183.88D	
	21200-KA010	410183.82D	17670-85C00	410229.82D	
	21200-KA050	410183.82D	17690 84A00	411043.89D	
	21200-KA070	410183.88D	17690-67JG0	410538.89D	
	21200-KA150	410183.82D	17690-79J50	410049.88D	
	21200-KA151	410183.82D	17690-84A10	411043.89D	
	21200-KA152	410183.82D	17690-84A11	411043.89D	
	21200-KA153	410183.82D	17690-84A50-000	411039.83D	
	21200-KA154	410183.82D	17690-84A51	411477.89D ▲	
	21210-AA030	410230.78D	17690-84E50-000	410588.88D	
	21210-AA080	411743.82D ▲			

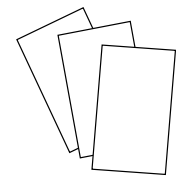

Manufacturer	Manufacturer's Ref.	Wahler-ref.	Manufacturer	Manufacturer's Ref.	Wahler-ref.
TALBOT	131 666.00	4026.89		13 38 018	3054.87D50
				13 38 024	4255.82D
TOYOTA	16340-54010	3477.88D		13 38 033	4255.87D
	90080-23002	3478.82D		13 38 038	4255.92D
	90916-03040	3119.88		13 38 041	3054.87D50
	90916-03040	3119.88D5		13 38 042	3021.88D50
	90916-03043	3477.88D		13 38 046	4115.92D
	90916-03043	4126.88		13 38 049	4144.92D
	90916-03046	4103.82D		13 38 052	3017.92D2
	90916-03055	3119.82D5		13 38 057	4164.92D
	90916-03060	3478.82D		13 38 060	4168.92D
	90916-03062	3477.88D		13 38 063	4164.92D
	90916-03062	4126.88		13 38 067	4175.92D
	90916-03065	4103.82D		13 38 068	4177.92D
	90916-03069	4103.82D		13 38 069	4180.82D
	90916-03072	3477.88D		13 38 073	4178.92D
	90916-03075	4480.82D		13 38 076	4237.80D
	90916-03078	3119.88D5		13 38 079	4183.92D
	90916-03079	411545.82D ▲		13 38 084	4175.92D
	90916-03081	411545.82D ▲		13 38 096	4459.92D
	90916-03084	4480.82D		13 38 466	4158.80D
	90916-03088	410178.82D		13 41 002	6010.95D
	90916-03090	3478.82D		13 41 011	6031.100D
	90916-03093	410231.82D		13 41 017	6031.105D
	90916-03095	3478.82D		13 41 028	6031.88D
	90916-03096	3478.82D		21 018 811	411193.82D
	90916-03097	410181.82D		24 405 922	4431.105D
	90916-03099	3477.88D		24 420 728	4297.92D
	90916-03101	410178.82D		24 435 781	4201.92D
	90916-03106	3477.88D		24 447 862	4433.92D
	90916-03109	3478.82D		24 456 401	411578.92D ▲
	90916-03115	3478.82D		40 191 1858	3021.88
	90916-03118	410181.82D		55 182 499	410588.88D
	90916-03120	410178.82D		55 202 510	410049.88D
	90916-03122	410201.80D		55 577 072	4431.105D
	90916-03123	410231.82D		9 108 106	4151.76D
	90916-03125	4480.82D		9 110 719	3470.89D50
	90916-03129	4480.82D		90 009 956	4115.92D
	90916-03133	4480.82D		90 067 918	4255.92D
	90916-03136	4480.82D		90 108 636	6010.95D
	90916-03140	4480.82D		90 242 277	6031.100D
	90916-03144	4480.82D		90 264 080	4144.92D
	90916-03145	4480.82D		90 277 288	6031.105D
	90916-54010	3477.88D		90 357 303	6031.88D
	90916-A3001	4480.82D		90 411 948	4177.92D
	90916-A3002	4480.82D		90 509 110	4237.80D
	90916-A3003	4480.82D		90 529 846	4188.92D
	SU001-0223	4446.83D		90 536 262	411578.92D ▲
				90 536 501	411578.92D ▲
VALTRA	114 470	4351.79		90 537 453	411193.82D
	149 620	4588.75/1		90 537 605	411193.82D
				90 537 811	411193.82D
VAUXHALL	02 898 440	3054.92D50		90 570 620	4459.92D
	08 966 485	4255.87D		90 572 899	4198.92D
	12 615 097	411193.82D		90 573 326	4208.92D
	12 622 410	411193.82D		90 573 926	4201.92D
	13 38 016	3054.92D50		91 153 670	4158.80D

## Cross References

Manufacturer	Manufacturer's Ref.	Wahler-ref.	Manufacturer	Manufacturer's Ref.	Wahler-ref.
VAUXHALL	91 159 950	3466.89D		059 121 113 A	4006.82D
	91 160 216	126104 ▲		059 121 113 B	4006.82D
	91 28 786	4207.92D		062 121 111 A	3145.79D
	91 29 907	4242.92D		062 121 111 B	3145.79D
	91 61 123	4174.79D		068 121 113 A	4256.71
	93 177 343	410588.88D		068 121 113 H	4253.87D
	93 179 136	410049.88D		069 121 113	4116.87D1
	93 181 245	411578.92D ▲		069 121 113 A	4116.87D1
	93 198 035	411476.83D ▲		06B 121 113 A	3141.87D
	93 198 289	411476.83D ▲		06C 121 111 C	4814.92D
	93 198 317	411476.83D ▲		06C 121 111 D	4814.92D
	93 198 576	411476.83D ▲		06C 121 111 E	4814.92D
	93 198 646	411476.83D ▲		06D 121 111 G	411186.87D
	94 372 762	3468.88D		06F 121 111 F	411187.87D
	97 087 130	3467.85D		070 121 114	4430.87D
				075 121 113 D	4123.80D
VM	3 901 2004 F	4158.80D		076 121 113 A	4123.70
	4 901 2012 F	4030.70		077 121 113	4274.87D
VOLKSWAGEN				077 121 113 B	4274.87D
	00A 121 113	4275.87D		077 121 113 C	4274.82D
	022 121 113	4455.80D		078 121 113	4274.87D
	025 121 113 D	4155.87D		078 121 113 C	4274.87D
	025 121 113 E	4155.87D		078 121 113 F	4274.87D
	025 121 113 F	4155.87D		078 121 113 J	4274.87D
	030 121 113	4264.84D		07K 121 113 B	4488.80D0
	030 121 113 B	4264.84D		07Z 121 111	4572.105D
	032 121 110 B	3143.87D		191 959 481 A	6017.95D
	032 121 110 B	410989.87D		191 959 481 B	6020.95D
	032 121 110 C	410989.80D		191 959 481 C	6017.95D
	032 121 110 F	3167.83D		1H0 959 481	6037.95D
	032 121 110 J	410989.87D		1H0 959 481 B	6037.95D
	032 121 110 L	410475.87D		251 959 481	6017.95D
	032 121 110 P	3143.87D		251 959 481 G	6087.87D
	032 121 113	4253.87D		251 959 481 H	6087.87D
	032 121 121 G	410475.87D		251 959 481 K	6087.87D
	032 121 121 K	410475.87D		321 959 481 A	6017.95D
	035 121 113	4088.80D		321 959 481 B	6020.95D
	035 121 113 B	4088.87D		321 959 481 C	6017.95D
	036 121 113	3091.92D		321 959 481 D	6017.95D
	036 121 113 A	3091.92D		321 959 481 E	6020.95D
	036 121 113 B	3091.92D		321 959 481 G	6020.95D
	037 121 113	4256.83D60		372 959 481 1	6039.95D
	03G 121 111 A	4820.87D		6U0 959 481 A	6017.95D
	03G 121 113	3472.87D		701 959 481	6037.87D
	03G 121 113 A	4820.87D		701 959 481 C	6037.81D
	03L 121 111 AE	410845.87D		701 959 481 J	6037.87D
	03L 121 111 R	410845.92D		811 959 481	6024.95D
	03L 121 111 S	410845.92D		823 959 481	6010.92D
	03L 121 113 B	410537.92D		823 959 481 A	6010.92D
	03L 121 114 B	410536.92D		823 959 481 F	6010.92D
	044 121 113	4264.87D		823 959 481 G	6010.95D
	050 121 113 C	3141.87D		823 959 481 H	6010.95D
	052 121 113 A	3091.92D		823 959 481 K	6010.95D
	056 121 113	4253.87D		823 959 481 L	6010.92D
	056 121 113 A	4256.80D		867 959 481	6039.95D
	056 121 113 D	4264.87D		893 959 481	6024.95D
	056 121 113 E	4256.71		9.407.0.757.002.4	3145.79D

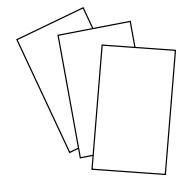

Manufacturer	Manufacturer's Ref.	Wahler-ref.		
	J 16 340 540 10	410201.80D		
	J 90 916 030 46	4103.82D		
	J 90 916 030 99	3477.88D		
	J 90 916 540 10	3477.88D		
<b>VOLVO</b>				
	1 219 150	4089.82D		
	1 544 097	4038.76D		
	1 544 098	4038.81D		
	1 544 389	4038.65D		
	1 544 683	4619.82		
	1 661 993	4619.75		
	1 665 694	4619.86		
	267 235	3029.89		
	271 417	4272.90D		
	271 664	4272.90D		
	272 246	4116.87D1		
	272 335	4206.90D		
	273 307	4089.92D		
	273 458	4022.88D		
	273 459	4089.87D		
	273 480	4122.87D		
	273 728	4088.87D		
	273 950	4038.65D		



## Cross References

Wahler-ref.	Manufacturer's Ref.	Manufacturer	Wahler-ref.	Manufacturer's Ref.	Manufacturer
<b>126104 ▲</b>	44 09 180	OPEL	<b>3000.90</b>	04494 469	CHRYSLER
	77 00 101 179	DACIA		04494469	JEEP
	77 00 101 179	RENAULT		5202 8185 AB	CHRYSLER
	77 00 866 387	DACIA		52028185	CHRYSLER
	77 00 866 387	RENAULT		52028185AB	JEEP
	82 00 561 420	DACIA		AT 22963	JOHN DEERE
	82 00 561 420	RENAULT		GTS 298	ROVER
	91 160 216	GM		RE 33705	JOHN DEERE
<b>2389.75/1</b>	77 00 024 756	RENAULT	<b>3004.74</b>	1 518 627	FORD
	F 281 200 050 20	FENDT		1 607 993	FORD
	F 281.200.050.020	DODGE	<b>3004.82</b>	13 38 030	OPEL
	X 815 090 003 000	FENDT		13 38 077	OPEL
<b>2391.75</b>	1215 2752	MWM	34 402 115	INNOCENTI	
	1215 2766	MWM	52 06 139	ASTON MARTIN	
	1227 0074	DEUTZ-FAHR	607 200 00 15	MERCEDES-BENZ	
	6 052 5 011 001 1	MWM	94 207 217	ISUZU	
	6 052 5 011 004 2	MWM	97 094 283	GM	
	60 05 000 004	RENAULT	<b>3004.88D1</b>	1 452 357	FORD
	60 05 004 616	RENAULT		891F 8575 AA	FORD
	77 00 024 756	RENAULT	<b>3004.92D1</b>	1 472 378	FORD
	F 150 204 050 10	FENDT		1E03-15-171	MAZDA
	F 150 204 050 11	FENDT		5 004 890	FORD
	F 150.204.050.011	DODGE		5 004 891	FORD
	X 815 090 002 000	FENDT		6 526 879	FORD
	X815.090.002.000	AGCO		691F 8575 BA	FORD
				89BM 8575 AC	FORD
<b>2393.75</b>	1227 0073	DEUTZ-FAHR	89BM 8575 AD	FORD	
	6 052 5 011 002 4	MWM	<b>3017.87D2</b>	96 143 939	CHEVROLET
	6 052 5 100 41	MWM		96 143 939	DAEWOO
	60 05 004 616	RENAULT	<b>3017.92D2</b>	13 38 052	OPEL
		13 38 052		VAUXHALL	
		90 200 836		GM	
		13 38 015 old number		OPEL	
<b>3000.75</b>	7483490	PERKINS	<b>3017.92D50</b>	13 38 015 old number	OPEL
				1 649 194	FORD
				40 191 1858	VAUXHALL
				1 497 689	FORD
<b>3000.80</b>	000 203 64 75	MERCEDES-BENZ	<b>3021.88</b>	1 509 953	FORD
	001 203 58 75	MERCEDES-BENZ		1 517 858	FORD
	003 203 22 75	MERCEDES-BENZ		1 520 969	FORD
	PF 52.842	PERKINS		1 635 905	FORD
<b>3000.83</b>	105.00.01.064.00	ALFA ROMEO	<b>3021.88D50</b>	13 38 042	OPEL
	105.00.01.064.01	ALFA ROMEO		13 38 042	VAUXHALL
	111 727	HOLDER		5 004 887	FORD
	21200-G3100	NISSAN		6 085 917	FORD
	3156283	CHRYSLER	6 085 918	FORD	
	31753-0100	SUBARU	6 100 630	FORD	
	406 2141	FIAT	6 201 207	FORD	
	406 2172	FIAT			
	406 5540	FIAT			
	408 6415	FIAT			
	413 8169	FIAT			
	413 8769	IVECO			
	AT 22961	JOHN DEERE			
	CA 032.221.01	SEAT			
	GTS 282	ROVER			
	HD 035 A01	HOLDER			

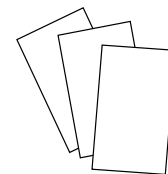

Wahler-ref.	Manufacturer's Ref.	Manufacturer	Wahler-ref.	Manufacturer's Ref.	Manufacturer
	6 201 247	FORD		13 38 041	OPEL
	800 572	FORD		13 38 041	VAUXHALL
	800 573	FORD			
	800 574	FORD	<b>3054.92D50</b>	02 898 440	GM
	81SF 8575 EA	FORD		02 898 440	VAUXHALL
	81SF 8575 FA	FORD		13 38 016	OPEL
	85HF 8575 AA	FORD		13 38 016	VAUXHALL
	91XM 8575 AA	FORD			
<b>3021.92D50</b>	6 100 629	FORD	<b>3061.82</b>	1337 47	PEUGEOT
				91 500 723	CITROËN
<b>3023.87D</b>	415 4312	FIAT		91 500 723 80	PEUGEOT
	415 4313	AUTOBIANCHI		9150 0723 80	FIAT
	415 4313	FIAT	<b>3061.88</b>	1337 49	PEUGEOT
	EA03222101	SEAT		91 500 724 80	PEUGEOT
<b>3029.83</b>	225 070	DAF	<b>3067.83</b>	6071 0617	ALFA ROMEO
	77 00 575 874	RENAULT			
	77 01 348 376	RENAULT	<b>3091.92D</b>	036 121 113	AUDI
<b>3029.86</b>	77 00 619 931	RENAULT		036 121 113	VOLKSWAGEN
	77 00 722 762	RENAULT		036 121 113 A	AUDI
	77 01 348 374	RENAULT		036 121 113 A	VOLKSWAGEN
<b>3029.89</b>	267 235	VOLVO		036 121 113 B	AUDI
	77 00 727 190	RENAULT		036 121 113 B	VOLKSWAGEN
	77 00 730 540	RENAULT		052 121 113 A	AUDI
	77 01 348 068	RENAULT	<b>3096.75</b>	052 121 113 A	VOLKSWAGEN
<b>3032.80</b>	113 095 0	SKODA		238 156	SCANIA
	113 095 091	SKODA	<b>3100.88D</b>	525 076	SCANIA
<b>3032.88</b>	114 095 090	SKODA		6 994 257	FORD
<b>3033.78D</b>	5454410R	CITROËN		95WM 8575 AA	FORD
	5490459C	CITROËN	<b>3100.92D</b>		
	75441833	CITROËN		4 356 548	FORD
	95 492 929	CITROËN		6 758 566	FORD
<b>3033.84D ▲</b>	1337 65	PEUGEOT		YU3E 8575 BA	FORD
	95 495 311	CITROËN	<b>3103.79</b>		
<b>3044.80</b>	65 540 40601	INNOCENTI		9845 0800	FIAT
<b>3044.90D1</b>	21200-01B00	NISSAN	<b>3105.87D</b>	754 5958	FIAT
<b>3053.75</b>	1337 26	CITROËN		7545 9580	AUTOBIANCHI
	1337 26	PEUGEOT		758 9135	FIAT
	6 058 784	FORD		758 9135	LANCIA
	79 100 118 73	CITROËN		7581 3190	AUTOBIANCHI
	79 100 118 73	PEUGEOT	<b>3109.82D</b>		
<b>3053.85</b>	77 01 348 139	RENAULT		758 1201	LANCIA
<b>3054.87D50</b>	02 898 688	GM		758 1636	LANCIA
	13 38 018	OPEL		7581 635	FIAT
	13 38 018	VAUXHALL	<b>3109.87D</b>		
				758 1200	FIAT
				758 1201	FIAT
			<b>3116.82D</b>		
				77 01 035 736	RENAULT
				77 01 039 156	RENAULT
				9849 8831	FIAT
			<b>3118.82D1</b>		
				21200-2H600	NISSAN

## Cross References

Wahler-ref.	Manufacturer's Ref.	Manufacturer	Wahler-ref.	Manufacturer's Ref.	Manufacturer	
3118.82D1	21200-41B00	NISSAN	3119.88D3	90916-03040	TOYOTA	
	21200-85G00	NISSAN		MD 997221	MITSUBISHI	
	21200-99B03	NISSAN		8173-99-152 A	MAZDA	
	21200-P7901	NISSAN		8173-99-152 B	MAZDA	
	21200-P7990	NISSAN		8AG4-15-171	MAZDA	
	21200-V0100	NISSAN		8AX1-15-171	MAZDA	
	21200-V0200	NISSAN		B541-15-171	MAZDA	
	21200-V0201	NISSAN		HE 41-99-152 A	MAZDA	
3118.88D1	21200-2H605	NISSAN	3119.88D4	MD 005131	MITSUBISHI	
	21200-78515	NISSAN		MD 972903	MITSUBISHI	
	21200-85G05	NISSAN		MD 997221	MITSUBISHI	
	21200-85G06	NISSAN		MD 997461	MITSUBISHI	
	21200-P7500	NISSAN		MD 997608	MITSUBISHI	
	21200-P7905	NISSAN				
	21200-P7906	NISSAN	3119.88D5	90916-03040	TOYOTA	
	21200-P7991	NISSAN		90916-03078	TOYOTA	
	21200-V0105	NISSAN	3136.82D50	1337 30	PEUGEOT	
	21200-V0205	NISSAN		1338 37	PEUGEOT	
	21200-V0206	NISSAN		1338 83	PEUGEOT	
				77 01 348 372	RENAULT	
		79 100 111 01		CITROËN		
		79 100 143 90		CITROËN		
3119.82	17600-83821-000	SUZUKI		79 100 165 60	CITROËN	
	19300-PA0-003	HONDA		96 171 780 80	CITROËN	
	19300-PB2-003	HONDA		9617 1780 80	FIAT	
	19300-PB2-004	HONDA	3136.88D50	1337 27	PEUGEOT	
	19300-PB2-013	HONDA		1338 11	CITROËN	
	19300-PB2-014	HONDA		1338 11	PEUGEOT	
	19300-PB2-024	HONDA		1338 44	CITROËN	
	19300-PB2-811	HONDA		1338 44	PEUGEOT	
	19300-PB2-812	HONDA		79 100 118 80	CITROËN	
	19300-PB2-815	HONDA	96 049 146	CITROËN		
	19300-PB2-816	HONDA	96 050 286 80	CITROËN		
	19300-PB2-817	HONDA	96 057 087 80	PEUGEOT		
	8124-99-152	MAZDA	96 057 136	CITROËN		
	90916-03040-000	DAIHATSU	96 057 136 80	PEUGEOT		
			96 196 379 80	PEUGEOT		
3119.82D3	HE 41-99-152 C	MAZDA	3141.87D	050 121 113 C	AUDI	
				050 121 113 C	SEAT	
3119.82D4	MD 001370	MITSUBISHI			050 121 113 C	SKODA
	MD 005371	MITSUBISHI			050 121 113 C	VOLKSWAGEN
	MD 008086	MITSUBISHI		3142.90D	06B 121 113 A	VOLKSWAGEN
	MD 075460	MITSUBISHI			0003179V009	SMART
	MD 117759	MITSUBISHI	0003179V010		SMART	
	MD 126168	MITSUBISHI	160 200 03 15		MERCEDES-BENZ	
	MD 972905	MITSUBISHI	Q0003179V010000000		SMART	
	MD 972908	MITSUBISHI				
	MD 997217	MITSUBISHI	3143.87D	032 121 110 B	AUDI	
	MD 997219	MITSUBISHI		032 121 110 B	SEAT	
	MD 997220	MITSUBISHI		032 121 110 B	SKODA	
	MD 997220	MITSUBISHI		032 121 110 B	VOLKSWAGEN	
MD 997602	MITSUBISHI					
MD 997603	MITSUBISHI					
MD 997607	MITSUBISHI					
3119.82D5	90916-03055	TOYOTA				
3119.88	3 257 449	FORD				
	90048-33021-000	DAIHATSU				

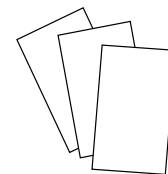

Wahler-ref.	Manufacturer's Ref.	Manufacturer	Wahler-ref.	Manufacturer's Ref.	Manufacturer
	032 121 110 P	AUDI	<b>3344.75</b>	11 53 1 260 720	BMW
	032 121 110 P	SEAT			
	032 121 110 P	SKODA	<b>3344.80</b>	11 53 1 253 248	BMW
	032 121 110 P	VOLKSWAGEN		11 53 1 253 249	BMW
				11 53 9 055 587	BMW
<b>3145.79D</b>	062 121 111 A	VOLKSWAGEN			
	062 121 111 B	VOLKSWAGEN	<b>3345.79</b>	0004218650	SEAT
	9 407 0 757 002 4	MWM		421 8649	AUTOBIANCHI
	9.407.0.757.002.4	VOLKSWAGEN		4218 6500	FIAT
<b>3146.90D</b>	0004698V002	SMART			
	0004698V003	SMART	<b>3355.80D</b>	594 2240	FIAT
	660 200 03 15	MERCEDES-BENZ		762 8527	FIAT
	660 200 05 15	SMART			
			<b>3356.80D</b>	8234 2688	LANCIA
<b>3151.87D</b>	4652 3118	FIAT			
	4673 7644	FIAT	<b>3360.87D</b>	762 8417	FIAT
<b>3159.82D</b>	1337 48	PEUGEOT	<b>3361.87D</b>	596 6787	FIAT
	595 0116	FIAT		596 9749	FIAT
	756 4583	FIAT		762 6622	FIAT
	761 5234	FIAT		SE 020 032 221 A	SEAT
	761 5235	FIAT			
			<b>3373.80D</b>	765 6384	FIAT
<b>3163.88D</b>	4652 2664	FIAT		765 6385	FIAT
	4652 2664	LANCIA			
	4677 6217	FIAT	<b>3378.80</b>	761 3433	FIAT
<b>3164.88</b>	4653 6104	FIAT	<b>3383.87</b>	755 4544	FIAT
	4677 6218	FIAT		769 2450	FIAT
				769 6535	FIAT
<b>3166.89D</b>	11061-00QAE	NISSAN			
	77 00 110 716	RENAULT	<b>3431.80D</b>	1336 A7	CITROËN
	82 00 660 882	DACIA		1336 A7	PEUGEOT
	82 00 660 882	RENAULT		4681 8413	FIAT
				599 9818	LANCIA
<b>3167.83D</b>	032 121 110 F	AUDI		759 7659	FIAT
	032 121 110 F	SEAT		759 9824	FIAT
	032 121 110 F	SKODA		762 5346	FIAT
	032 121 110 F	VOLKSWAGEN		762 5347	FIAT
<b>3169.79D</b>	50 404 5799	IVECO	<b>3457.90D</b>	271 200 00 15	MERCEDES-BENZ
	50 408 4365	IVECO		271 203 03 75	MERCEDES-BENZ
<b>3171.82D</b>	50 401 7209	IVECO	<b>3463.89D</b>	1336 N5	CITROËN
				1336 N5	PEUGEOT
<b>3174.89D</b>	77 00 868 980	RENAULT		1336 Q1	CITROËN
				1336 Q1	PEUGEOT
<b>3300.80D</b>	779 4132	FIAT		96 300 66 780	CITROËN
				96 300 667 80	PEUGEOT
<b>3301.80D</b>	777 0416	FIAT			
			<b>3466.89D</b>	44 08 334	OPEL
<b>3302.80D</b>	774 1883	FIAT		60 01 543 366	RENAULT
				77 00 872 554	DACIA
<b>3333.87</b>	21080-13060-10	LADA		77 00 872 554	RENAULT
	2108-13060-10	LADA		77 00 872 635	RENAULT
	21081-3060-11	LADA		82 00 772 985	DACIA
				82 00 772 985	RENAULT

## Cross References

Wahler-ref.	Manufacturer's Ref.	Manufacturer	Wahler-ref.	Manufacturer's Ref.	Manufacturer
3466.89D	91 159 950	GM	3478.82D	21200-4M500	NISSAN
	91 159 950	VAUXHALL		21200-77A05	NISSAN
3467.85D	13 38 075	OPEL	21200-77A65	NISSAN	
	8-79312-726-0	ISUZU	21200-77A66	NISSAN	
	8-94360-227-0	ISUZU	21200-86J00	NISSAN	
	8-97087-130-2	ISUZU	21200-86J01	NISSAN	
	97 087 130	GM	21200-90J00	NISSAN	
	97 087 130	VAUXHALL	21200-90J10	NISSAN	
			21200-9F600	NISSAN	
3468.88D	13 38 056	OPEL	90080-23002	TOYOTA	
	17670-78E00	SUZUKI	90916-03060	TOYOTA	
	8-94123-295-0	ISUZU	90916-03090	TOYOTA	
	8-94123-295-1	ISUZU	90916-03090-000	DAIHATSU	
	8-94372-762-0	ISUZU	90916-03095	TOYOTA	
	8AG1-15-171	MAZDA	90916-03096	TOYOTA	
	8AG1-15-171A	MAZDA	90916-03109	TOYOTA	
	8AG2-15-171	MAZDA	90916-03115	TOYOTA	
	8AG2-15-171A	MAZDA			
	8AG6-15-171	MAZDA	3481.88D	4646 4992	FIAT
	8AG7-15-171	MAZDA	4651 3506	FIAT	
	8AG8-15-171	MAZDA	4652 3733	FIAT	
	8AZ1-15-171	MAZDA	4677 6216	FIAT	
	94 372 762	GM			
	94 372 762	VAUXHALL	3483.89D	1338 A0	CITROËN
	RF03-15-171A	MAZDA	1338 A0	PEUGEOT	
			96 300 666 80	CITROËN	
		96 300 666 80	PEUGEOT		
3469.91D	77 00 742 617	RENAULT			
	77 00 858 802	RENAULT	3484.87D	775 9596	FIAT
3470.89D50	3 344 616	VOLVO			
	3 345 628	VOLVO	3485.87D	772 2107	FIAT
	44 02 719	OPEL			
	77 00 723 945	RENAULT	3497.88D	1 096 283	FORD
	77 00 866 896	RENAULT	1338 F5	CITROËN	
	77 00 872 314	RENAULT	1338 F5	PEUGEOT	
	77 01 348 373	RENAULT	XS7Q 8575 AA	FORD	
	9 110 719	GM			
	9 110 719	VAUXHALL	3498.88D	0K710-15-171	KIA
	M-474877	MITSUBISHI	0K9FC-15-171	KIA	
	M-863985	MITSUBISHI	8AB1-15-171	MAZDA	
		8AB5-15-171	MAZDA		
3472.87D	03G 121 113	AUDI	8AB8-15-171	MAZDA	
	03G 121 113	SEAT	8ABE-15-171	MAZDA	
	03G 121 113	SKODA	8AG3-15-171	MAZDA	
	03G 121 113	VOLKSWAGEN	8AG5-15-171	MAZDA	
	MN 980137	MITSUBISHI	8AK1-15-171	MAZDA	
			8AN1-15-171	MAZDA	
3477.88D	16340-54010	TOYOTA	8AU1-15-171	MAZDA	
	90916-03043	TOYOTA	8AU-15-171	MAZDA	
	90916-03062	TOYOTA	AB6-15-171	MAZDA	
	90916-03072	TOYOTA	B6H-15-171	MAZDA	
	90916-03099	TOYOTA	B6H-15-171 A	MAZDA	
	90916-03106	TOYOTA	BP6F-15-171	MAZDA	
	90916-54010	TOYOTA	BPD3-15-171	MAZDA	
	J 90 916 030 99	VOLKSWAGEN	E5D3-15-171	MAZDA	
	J 90 916 540 10	VOLKSWAGEN	F201-15-171	MAZDA	

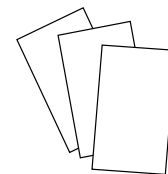

Wahler-ref.	Manufacturer's Ref.	Manufacturer	Wahler-ref.	Manufacturer's Ref.	Manufacturer		
3499.82D	KE5D3-15-171	KIA	4017.82	77 01 026 647	RENAULT		
	ZZ40-15-171	MAZDA		3059 676 R 1	INTER. HARV. IHC		
	0223-15-171	MAZDA		3059 676 R 91	INTER. HARV. IHC		
	0419-15-171	MAZDA		3059 676 R 92	INTER. HARV. IHC		
	0419-99-152	MAZDA		3228 046 R 2	INTER. HARV. IHC		
	8AB7-15-171	MAZDA		3228 046 R1	INTER. HARV. IHC		
	8AB9-15-171	MAZDA		4022.82D	75 02 297	SAAB	
	8ABC-15-171	MAZDA			93 37 551	SAAB	
	B366-15-171	MAZDA			94 214 962	ISUZU	
	B3H3-15-171	MAZDA		4022.82D1	754 0318	FIAT	
	B3H8-15-171A	MAZDA			754 0318	LANCIA	
	HE 41-99-152C	MAZDA			761 5234	ALFA ROMEO	
	HE 41-99-152D	MAZDA			765 6567	FIAT	
	3499.88D	8173-15-152 C		MAZDA	4022.88D	273 458	VOLVO
8173-15-171		MAZDA	83 89 512	SAAB			
8173-99-152		MAZDA	4022.92D	93 20 284		SAAB	
8173-99-152 A		MAZDA		4026.89		131 666.00	TALBOT
8173-99-152 B		MAZDA				4029.81	466 017
8ABA-15-171		MAZDA	4030.70	4 901 2012 F			VM
8ABB-15-171		MAZDA		461.0943		SAURER	
8ABB-15-171A		MAZDA	4033.82D	422 0309		FIAT	
8ABD-15-171		MAZDA		443 7481		FIAT	
8AG4-15-171		MAZDA	4038.65D	1 544 389		VOLVO	
8AX1-15-171		MAZDA		273 950		VOLVO	
B541-15-171		MAZDA		3 831 426		VOLVO	
4003.86		6050 4230		ALFA ROMEO		424 370	VOLVO
		4006.82D		059 121 113 A		AUDI	466 127
	059 121 113 A			VOLKSWAGEN	4038.71D	875 788	VOLVO
059 121 113 B	AUDI			4038.76D		1 544 097	VOLVO
059 121 113 B	VOLKSWAGEN	273 951	VOLVO				
8AB3 15 171	MAZDA	273 953	VOLVO				
C28067	JAGUAR	875 787	VOLVO				
C33012	JAGUAR	4038.81D	1 544 098	VOLVO			
C37129	JAGUAR		273 952	VOLVO			
4007.80D	1000208309	LOMBARDINI	4049.80D	617 200 03 15	MERCEDES-BENZ		
	1285 0152	DEUTZ-FAHR		617 200 11 15	MERCEDES-BENZ		
	1285 1663	DEUTZ-FAHR		4049.80D1	617 200 18 15	MERCEDES-BENZ	
	9195 057	LOMBARDINI			4064.75D	002 203 82 75	MERCEDES-BENZ
	9195 1240	LOMBARDINI				116 200 00 15	MERCEDES-BENZ
ED0091951240S	LOMBARDINI	4078.65D	004 203 65 75	MERCEDES-BENZ			
4008.74D	465 5782		FIAT				
	467 4169	FIAT					
	470 3624	FIAT					
	470 3625	FIAT					
	482 3226	FIAT					
4008.79D	104 9195 092	LOMBARDINI					
	468 4390	IVECO					
	470 3088	IVECO					
	475 0024	FIAT					
	6071 3535	ALFA ROMEO					

## Cross References

Wahler-ref.	Manufacturer's Ref.	Manufacturer	Wahler-ref.	Manufacturer's Ref.	Manufacturer
4078.71D	002 203 16 75	MERCEDES-BENZ	410016.98D	1 473 089	FORD
	002 203 31 75	MERCEDES-BENZ		1 473 090	FORD
	110 200 09 15	MERCEDES-BENZ		7S7G 6L721 AA	FORD
4078.75D	770275	PEGASO		7S7G 6L721 AB	FORD
4078.79D	001 203 90 75	MERCEDES-BENZ	410048.88D	13 38 020	OPEL
	002 203 35 75	MERCEDES-BENZ		5519 4271	FIAT
	002 203 37 75	MERCEDES-BENZ		5520 2373	FIAT
	002 203 38 75	MERCEDES-BENZ		63 38 039	OPEL
	002 203 46 75	MERCEDES-BENZ		93 18 4200	OPEL
	002 203 72 75	MERCEDES-BENZ			
	002 203 78 75	MERCEDES-BENZ		410049.88D	13 38 039
100 200 07 15	MERCEDES-BENZ	13 38 154	OPEL		
4078.87D	001 203 91 75	MERCEDES-BENZ		13 38 275	OPEL
	002 203 76 75	MERCEDES-BENZ		17690-79J50	SUZUKI
	002 203 81 75	MERCEDES-BENZ		55 20 3388	SAAB
	100 200 05 15	MERCEDES-BENZ		55 202 510	GM
	102 200 08 15	MERCEDES-BENZ		55 202 510	VAUXHALL
	102 200 14 15	MERCEDES-BENZ		5518 7784	FIAT
	102 200 15 15	MERCEDES-BENZ		5520 2510	ALFA ROMEO
	102 200 19 15	MERCEDES-BENZ		5520 2510	FIAT
	110 200 01 11	MERCEDES-BENZ		5520 3388	FIAT
	110 200 05 15	MERCEDES-BENZ		7175 4778	ALFA ROMEO
				7175 4778	FIAT
				93 179 136	GM
	4078.92D	004 203 86 75	MERCEDES-BENZ		93 179 136
110 200 19 15		MERCEDES-BENZ			
4083.79 •	738 0833	LIEBHERR	410055.87D ▲	642 200 08 15	MERCEDES-BENZ
4083.83D50	001 203 69 75	MERCEDES-BENZ	410058.84D	1338 38	CITROËN
	002 203 04 75	MERCEDES-BENZ		1338 38	PEUGEOT
	002 203 53 75	MERCEDES-BENZ		96 145 00 980	CITROËN
4088.80D	035 121 113	AUDI	410075.79D ▲	1336 AA	CITROËN
	035 121 113	VOLKSWAGEN		1336 AA	PEUGEOT
				50 413 2246	IVECO
4088.87D	035 121 113 B	AUDI	410081.79D	50 415 0562	FIAT
	035 121 113 B	VOLKSWAGEN		50 415 0562	IVECO
	273 728	VOLVO			
4089.82D	1 219 150	VOLVO	410086.97D0	11 53 7 536 655	BMW
	463 433	VOLVO		11 53 7 544 788	BMW
				11 53 7 549 476	BMW
4089.87D	273 459	VOLVO	410087.97D0		
				11 53 7 550 172	BMW
4089.92D	273 307	VOLVO	410090.88D	5519 3669	FIAT
				5519 4029	FIAT
				5520 2176	FIAT
				5523 9819	FIAT
4091.82D	435 1196	FIAT	410131.88D	1 086 282	FORD
	4355 8460	AUTOBIANCHI		1E07-15-171	MAZDA
	440 9254	FIAT		1E07-15-171 A	MAZDA
	4409 2540	AUTOBIANCHI		6 169 774	FORD
4094.71/1	0117 2667	DEUTZ-FAHR		89FF 8575 AB	FORD
	0117 2668	DEUTZ-FAHR			
410007.87D	772 9959	FIAT			

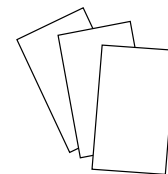

Wahler-ref.	Manufacturer's Ref.	Manufacturer	Wahler-ref.	Manufacturer's Ref.	Manufacturer
410171.87D	5080 146 AB	DODGE	410183.88D	17600-77820	SUZUKI
	611 200 02 15	MERCEDES-BENZ		17600-85821	SUZUKI
	611 200 07 15	MERCEDES-BENZ		17670-50G10	SUZUKI
	611 203 04 75	MERCEDES-BENZ		17670-50G20	SUZUKI
	611 203 05 75	MERCEDES-BENZ		17670-67H00	SUZUKI
	611 203 15 75	MERCEDES-BENZ		17670-76G10	SUZUKI
	611 203 19 75	MERCEDES-BENZ		17670-77G10	SUZUKI
	646 200 12 15	MERCEDES-BENZ		17670-85020	SUZUKI
410174.92D	646 200 00 15	MERCEDES-BENZ	410184.89D	21200-KA070	SUBARU
	646 200 11 15	MERCEDES-BENZ		96 610 574	GM
	646 203 02 75	MERCEDES-BENZ		1336 Q2	CITROËN
410176.82D0	21200-57J00	NISSAN	410201.80D	1336 Q2	PEUGEOT
	21200-57J15	NISSAN		96â485 426 80	PEUGEOT
410176.88D0	21200-57J05	NISSAN	410224.78D	90048-33088	DAIHATSU
410178.82D	90916-03088	TOYOTA		90916-03122	TOYOTA
	90916-03101	TOYOTA		J 16 340 540 10	VOLKSWAGEN
	90916-03120	TOYOTA	19300-P08-014	HONDA	
410179.84D	90048-33078	DAIHATSU	19300-PDA-E01	HONDA	
	90048-33083	DAIHATSU	19300-PJ7-003	HONDA	
	90048-33092	DAIHATSU	19300-PJ7-004	HONDA	
410180.82D	MD 174233	MITSUBISHI	19300-PM3-003	HONDA	
	MD 194988	CHRYSLER	19300-PM3-004	HONDA	
	MD 194988	MITSUBISHI	19300-PR3-003	HONDA	
	MD 348937	MITSUBISHI	19300-PT0-003	HONDA	
	MD 351495	MITSUBISHI	19300-PT0-004	HONDA	
	MD 997644	MITSUBISHI	19301-P08-000	HONDA	
	ME 220538	MITSUBISHI	19301-P08-305	HONDA	
	ME 241816	MITSUBISHI	19301-P08-306	HONDA	
410181.82D	90916-03097	TOYOTA	19301-P08-315	HONDA	
	90916-03118	TOYOTA	19301-P08-316	HONDA	
410182.84D	90048-33047	DAIHATSU	19301-P10-307	HONDA	
	90048-33056	DAIHATSU	19301-P1K-307	HONDA	
410183.82D	17600-85811	SUZUKI	19301-PAA-305	HONDA	
	17670-50G00	SUZUKI	19301-PAA-306	HONDA	
	17670-76A00	SUZUKI	19301-PDF-305	HONDA	
	17670-76A01	SUZUKI	19301-PLC-305	HONDA	
	17670-76G00	SUZUKI	19301-PLC-315	HONDA	
	17670-77G00	SUZUKI	19301-REA-305	HONDA	
	17670-82810-000	SUZUKI	19301-RME-305	HONDA	
	21200-KA010	SUBARU	19301-RP3-305	HONDA	
	21200-KA050	SUBARU	5-86000-349-0	ISUZU	
	21200-KA150	SUBARU	5-86000-350-0	ISUZU	
	21200-KA151	SUBARU	5-86012-056	ISUZU	
	21200-KA152	SUBARU	5-86014-381-0	ISUZU	
	21200-KA153	SUBARU	5-86018-963	ISUZU	
	21200-KA154	SUBARU	5-86018-964-0	ISUZU	
	94 580 182	GM	5-86019-507-0	ISUZU	
			5-86019-513-0	ISUZU	
		19301-P07-306	HONDA		
		19301-P07-316	HONDA		
		19301-PWA-305	HONDA		
		19301-PZA-305	HONDA		
		19301-RNA-305	HONDA		



## Cross References

Wahler-ref.	Manufacturer's Ref.	Manufacturer	Wahler-ref.	Manufacturer's Ref.	Manufacturer	
410224.82D	19301-RNA-306	HONDA	410348.82D	25500-23001	HYUNDAI	
	19301-RNA-307	HONDA		410351.88D	25500-22600	HYUNDAI
	5-86008138	ISUZU	410225.78D		19301-PNA-003	HONDA
410226.78D	19301-RAF-003	HONDA	410352.82D		0K2A-15-171	KIA
410228.82D	19301-RAF-004	HONDA		KHE41-15-171	KIA	
410228.82D	17570-74000	SUZUKI	410352.88D	0K2C0-15-171A	KIA	
	17570-740001	SUZUKI		410389.103D ▲	271 200 01 15	MERCEDES-BENZ
	17600-83810	SUZUKI			271 200 02 15	MERCEDES-BENZ
	17600-83811	SUZUKI	271 200 03 15		MERCEDES-BENZ	
	17600-83820	SUZUKI	410475.87D	032 121 110 L	AUDI	
	17600-83821	SUZUKI		032 121 110 L	SEAT	
	17600-83822	SUZUKI		032 121 110 L	SKODA	
	17600-83823	SUZUKI		032 121 110 L	VOLKSWAGEN	
	17600-85830	SUZUKI		032 121 121 G	AUDI	
	17600-85831	SUZUKI		032 121 121 G	SEAT	
	17670-73000	SUZUKI		032 121 121 G	SKODA	
	17670-73020	SUZUKI		032 121 121 G	VOLKSWAGEN	
	17670-73021	SUZUKI		032 121 121 K	AUDI	
	17670-83000	SUZUKI		032 121 121 K	SEAT	
	17670-83001	SUZUKI	032 121 121 K	SKODA		
	17670-83010	SUZUKI	032 121 121 K	VOLKSWAGEN		
	17670-83011	SUZUKI	410488.88D	21200-BX000	NISSAN	
410229.82D	17670-63J00	SUZUKI		4105.71D	002 203 39 75	MERCEDES-BENZ
17670-65D00	SUZUKI	003 203 29 75			MERCEDES-BENZ	
17670-77E00	SUZUKI	003 203 32 75			MERCEDES-BENZ	
17670-85C00	SUZUKI	003 203 74 75			MERCEDES-BENZ	
7174 2133	FIAT	003 203 79 75	MERCEDES-BENZ			
410230.78D	21200-AA071	SUBARU	004 203 84 75		MERCEDES-BENZ	
21200-AA072	SUBARU	005 203 28 75	MERCEDES-BENZ			
21210-AA030	SUBARU	4105.75D	474 9724	IVECO		
410231.82D	11 53 7 791 072		BMW	4105.79D	003 203 91 75	MERCEDES-BENZ
90916-03093	TOYOTA		003 203 92 75		MERCEDES-BENZ	
90916-03123	TOYOTA	004 203 85 75	MERCEDES-BENZ			
410262.91D	5278 144 AA	CHRYSLER	005 203 27 75		MERCEDES-BENZ	
410263.91D	11 53 1 485 847	BMW	4105.83D		002 203 32 75	MERCEDES-BENZ
11 53 1 501 173	BMW	002 203 45 75		MERCEDES-BENZ		
11 53 7 596 787	BMW	002 203 47 75		MERCEDES-BENZ		
4693 117 AA	CHRYSLER	002 203 49 75		MERCEDES-BENZ		
410289.81D	50 425 8346	IVECO		002 203 56 75	MERCEDES-BENZ	
50 432 0545	IVECO	002 203 59 75		MERCEDES-BENZ		
002 203 79 75		MERCEDES-BENZ				
002 203 90 75		MERCEDES-BENZ				
4103.82D	90916-03046	TOYOTA	003 203 14 75	MERCEDES-BENZ		
90916-03046-000	DAIHATSU	003 203 28 75	MERCEDES-BENZ			
90916-03065	TOYOTA	003 203 31 75	MERCEDES-BENZ			
90916-03069	TOYOTA	003 203 73 75	MERCEDES-BENZ			
J 90 916 030 46	VOLKSWAGEN	003 203 78 75	MERCEDES-BENZ			
			004 203 83 75	MERCEDES-BENZ		

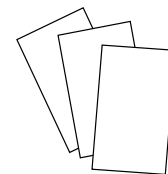

Wahler-ref.	Manufacturer's Ref.	Manufacturer	Wahler-ref.	Manufacturer's Ref.	Manufacturer
	005 203 26 75	MERCEDES-BENZ		03L 121 113 B	SKODA
	373 203 70 75	MERCEDES-BENZ		03L 121 113 B	VOLKSWAGEN
	83 129 996 050	EVOBUS			
<b>410511.88D</b>	4679 0294	FIAT	<b>410538.89D</b>	11060-00QAF	NISSAN
	4679 0294	LANCIA		17690-67JG0	SUZUKI
	6081 6681	ALFA ROMEO		82 00 112 054	RENAULT
<b>410512.88D</b>	4654 6375	FIAT	<b>410588.88D</b>	17690-84E50-000	SUZUKI
	4654 6375	LANCIA		47 08 757	OPEL
	6081 5681	ALFA ROMEO		55 182 499	GM
<b>410513.88D</b>	4652 0785	FIAT		55 182 499	VAUXHALL
	4652 0785	LANCIA		5519 9402	FIAT
	779 4218	FIAT		63 38 022	OPEL
	779 4218	LANCIA		93 177 343	GM
<b>410514.88D</b>	6065 3946	FIAT	<b>410589.88D</b>	93 177 343	VAUXHALL
	6081 4382	FIAT		93 19 3581	GM
<b>410515.88D</b>	4641 7962	FIAT	<b>410590.88D</b>	4678 5392	FIAT
<b>410516.88D</b>	779 1178	FIAT		6066 3619	ALFA ROMEO
<b>410517.83D</b>	11061-00QAB	NISSAN	<b>410591.88D</b>	4675 8586	FIAT
	11061-00QAC	NISSAN	<b>410608.86D</b>	50 409 6443 Kit	IVECO
	44 08 928	OPEL	<b>410692.71D</b>	592 1206	FIAT
	44 32 983	OPEL	<b>410705.89D</b>	1336 Z0	CITROËN
	82 00 074 349	RENAULT		1336 Z0	PEUGEOT
	82 00 674 369	RENAULT		96 472 659 80	PEUGEOT
	91 160 168	GM	<b>410758.83D</b>	50 10 295 225 2x Kit	RENAULT
	93 198 017	GM	<b>410763.82D</b>	9849 8322 Kit	IVECO
<b>410517.89D</b>	11060-AW300	NISSAN	<b>410765.90D ▲</b>	31293556	VOLVO
	11061-00QAD	NISSAN	<b>410766.103D0 ▲</b>	11 53 7 601 158	BMW
	44 04 305	OPEL	<b>410792.95D</b>	11 53 1 247 125	BMW
	82 00 074 346	RENAULT		11 53 1 432 881	BMW
	82 00 674 368	RENAULT		11 53 1 739 755	BMW
	9 112 305	GM	<b>410793.95D</b>	11 51 7 500 597	BMW
<b>410518.89D</b>	77 00 112 491	RENAULT	<b>410806.88D</b>	PEL 000170	ROVER
	77 01 474 248	RENAULT	<b>410808.88D</b>	GTS 301	ROVER
<b>410520.92D ▲</b>	708 3256	FIAT		PEL 10016	ROVER
	93 275 736	GM	<b>410828.82D</b>	50 00 684 865 Kit	RENAULT
	93235636	BUICK	<b>410828.82D0</b>	50 00 684 865	RENAULT
<b>410530.89D</b>	77 00 109 641	RENAULT	<b>410828.86D</b>	50 00 691 267 Kit	RENAULT
	77 01 474 249	RENAULT	<b>410828.86D0</b>	50 00 691 267	RENAULT
<b>410536.92D</b>	03L 121 114 B	AUDI			
	03L 121 114 B	SEAT			
	03L 121 114 B	SKODA			
	03L 121 114 B	VOLKSWAGEN			
<b>410537.92D</b>	03L 121 113 B	AUDI			
	03L 121 113 B	SEAT			

## Cross References

Wahler-ref.	Manufacturer's Ref.	Manufacturer	Wahler-ref.	Manufacturer's Ref.	Manufacturer
410845.87D	03L 121 111 AE	AUDI	411040.83D	11060-00QAJ	NISSAN
	03L 121 111 AE	SEAT		82 00 400 553	RENAULT
	03L 121 111 AE	SKODA		82 00 558 751	RENAULT
	03L 121 111 AE	VOLKSWAGEN			
410845.92D	03L 121 111 R	AUDI	411042.89D	82 00 267 349	RENAULT
	03L 121 111 R	SEAT		82 00 558 766	RENAULT
	03L 121 111 R	SKODA	411043.89D	11060-BN700	NISSAN
	03L 121 111 R	VOLKSWAGEN		11061-00Q0E	NISSAN
	03L 121 111 S	AUDI		11061-00QAG	NISSAN
	03L 121 111 S	SEAT		11061-00QAL	NISSAN
	03L 121 111 S	SKODA		17690 84A00	SUZUKI
	03L 121 111 S	VOLKSWAGEN		17690-84A10	SUZUKI
410864.71D0	81.06401.0019	MAN	17690-84A11	SUZUKI	
	81.06401.0042	MAN	82 00 039 885	RENAULT	
410864.79D0	81.06401.0037	MAN	82 00 171 021	RENAULT	
	81.06401.0046	MAN	82 00 244 402	RENAULT	
410864.83D0	81.06401.0038	MAN	82 00 374 994	DACIA	
	81.06401.0045	MAN	82 00 374 994	RENAULT	
	9011 0080	DEUTZ-FAHR	82 00 558 783	DACIA	
			82 00 558 783	RENAULT	
410871.80D ▲	0489 2642 AC	CHRYSLER	82 00 954 285	RENAULT	
	5521 5006	ALFA ROMEO	411045.82D	50 10 284 184	RENAULT
	5521 5006	FIAT		657 GC 324 A-P80	MACK
410937.82D ▲	50 438 7382	IVECO	411133.80D	129 3885 / F75-85-95	DAF
				129 3885 / F75-85-95	PACCAR
410956.83D	777 3790	FIAT	411135.83D	168 4900 / CF 75	DAF
410989.80D	032 121 110 C	VOLKSWAGEN		168 4900 / CF 75	PACCAR
410989.87D	032 121 110 B	SEAT	411135.87D	166 1375 / CF 75	DAF
	032 121 110 B	SKODA		166 1375 / CF 75	PACCAR
	032 121 110 B	VOLKSWAGEN	411186.87D	06D 121 111 G	AUDI
	032 121 110 J	SEAT		06D 121 111 G	SEAT
	032 121 110 J	SKODA		06D 121 111 G	SKODA
	032 121 110 J	VOLKSWAGEN		06D 121 111 G	VOLKSWAGEN
410994.88D	4680 4764	FIAT	411187.87D	06F 121 111 F	AUDI
411004.80D	1 423 451	SCANIA		06F 121 111 F	SEAT
	1 799 757	SCANIA		06F 121 111 F	SKODA
	1 800 909	SCANIA		06F 121 111 F	VOLKSWAGEN
	1 849 060	SCANIA			
411039.83D	11061-00Q0D	NISSAN	411193.82D	12 61 5097	SAAB
	11061-00QAM	NISSAN		12 615 097	GM
	17690-84A50-000	SUZUKI		12 615 097	VAUXHALL
	82 00 244 023	RENAULT		12 62 2410	SAAB
	82 00 400 554	DACIA		12 622 410	GM
	82 00 400 554	RENAULT		12 622 410	VAUXHALL
	82 00 558 758	DACIA		13 38 007	OPEL
	82 00 558 758	RENAULT		13 38 008	OPEL
	82 00 954 288	DACIA		13 38 034	OPEL
	82 00 954 288	RENAULT		13 38 427	OPEL
				21 018 811	GM

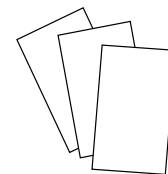

Wahler-ref.	Manufacturer's Ref.	Manufacturer	Wahler-ref.	Manufacturer's Ref.	Manufacturer	
411241.82D	21 018 811	VAUXHALL	411477.89D ▲	93 198 576	VAUXHALL	
	5177 0698	ALFA ROMEO		93 198 646	GM	
	7350 2809	FIAT		93 198 646	VAUXHALL	
	90 53 7453	SAAB				
	90 53 7811	SAAB		11 06 023 09R	RENAULT	
	90 537 453	GM		17690-84A51	SUZUKI	
	90 537 453	VAUXHALL		82 00 248 531	RENAULT	
	90 537 605	GM		82 00 558 779	RENAULT	
	90 537 605	VAUXHALL				
	90 537 811	GM		411481.89D ▲	82 00 954 289	RENAULT
	90 537 811	VAUXHALL				
411442.83D ▲	21200-ED000	NISSAN	4115.92D	13 38 046	OPEL	
	21200-ED00A	NISSAN	13 38 046	VAUXHALL		
	77 01 068 770	RENAULT	90 009 956	GM		
			90 009 956	VAUXHALL		
411475.89D ▲	11 06 030 26R	RENAULT	90 156 558	GM		
	11 06 055 36R	RENAULT	411545.82D ▲	90916-03079	LEXUS	
	11060-00Q0K	NISSAN	90916-03079	TOYOTA		
	11060-00Q0S	NISSAN	90916-03081	LEXUS		
	82 00 954 328	RENAULT	90916-03081	TOYOTA		
	11060-00Q0C	NISSAN				
	11060-00Q0E	NISSAN	411573.105D ▲	11 53 1 436 042	BMW	
	11060-00QAL	NISSAN	11 53 1 437 085	BMW		
	82 00 380 898	RENAULT				
	82 00 656 419	RENAULT	411574.102D ▲	11 53 7 552 403	BMW	
	82 00 656 420	RENAULT				
82 00 699 392	RENAULT	411576.87D ▲	166 203 00 75	MERCEDES-BENZ		
82 00 703 139	RENAULT	166 203 01 75	MERCEDES-BENZ			
82 00 801 570	RENAULT	166 203 02 75	MERCEDES-BENZ			
82 00 801 571	RENAULT					
82 00 907 229	RENAULT	411577.80D ▲	266 203 02 75	MERCEDES-BENZ		
82 00 907 234	RENAULT	266 203 04 75	MERCEDES-BENZ			
411476.83D ▲			266 203 06 75	MERCEDES-BENZ		
	11061-00Q0A	NISSAN	411578.92D ▲	1338 001	OPEL	
	11061-00Q0B	NISSAN	1338 098	OPEL		
	11061-00Q0G	NISSAN	24 456 401	GM		
	11061-00Q0K	NISSAN	24 456 401	VAUXHALL		
	11061-00Q0L	NISSAN	6338 005	OPEL		
	11061-00Q1B	NISSAN	6338 035	OPEL		
	44 33 121	OPEL	640972	SAAB		
	44 34 144	OPEL	90 536 262	GM		
	44 34 190	OPEL	90 536 262	VAUXHALL		
	44 49 134	OPEL	90 536 501	GM		
	44 49 506	OPEL	90 536 501	VAUXHALL		
	82 00 403 437	RENAULT	93 181 245	GM		
	82 00 703 140	RENAULT	93 181 245	VAUXHALL		
	82 00 801 567	RENAULT				
	82 00 907 239	RENAULT	411579.92D ▲	1338 004	OPEL	
	82 00 907 243	RENAULT	9158251	GM		
	93 198 035	GM				
	93 198 035	VAUXHALL	4116.87D1	069 121 113	AUDI	
	93 198 289	GM	069 121 113	VOLKSWAGEN		
	93 198 289	VAUXHALL	069 121 113 A	VOLKSWAGEN		
	93 198 317	GM	272 246	VOLVO		
	93 198 317	VAUXHALL	3 273 728	VOLVO		
	93 198 576	GM				

## Cross References

Wahler-ref.	Manufacturer's Ref.	Manufacturer	Wahler-ref.	Manufacturer's Ref.	Manufacturer
4117.80D	002 203 75 75	MERCEDES-BENZ	4147.80D	90 264 080	VAUXHALL
	002 203 80 75	MERCEDES-BENZ		90 354 822	DAEWOO
	615 200 13 15	MERCEDES-BENZ			
	616 200 04 15	MERCEDES-BENZ		1 612 191	FORD
411715.84D ▲				1337 64	PEUGEOT
	21200-AA140	SUBARU		1337 68	PEUGEOT
	21200-AA160	SUBARU		1338 20	PEUGEOT
	21200-AA220	SUBARU		1338 25	PEUGEOT
	21200-AA230	SUBARU		6 182 480	FORD
	21210-AA140	SUBARU		77 00 665 226	RENAULT
21210-AA160	SUBARU	77 00 697 157		RENAULT	
411716.88D ▲				77 00 858 087	RENAULT
	21200-AA150	SUBARU	77 00 862 200	RENAULT	
	21200-AA200	SUBARU	93 501 145	CITROËN	
	21210-AA120	SUBARU	93 501 386	CITROËN	
411743.82D ▲	21210-AA150	SUBARU	96 090 230 80	PEUGEOT	
	21200-AA170	SUBARU	96 159 513	CITROËN	
	21210-AA080	SUBARU	GTS 303	LANDROVER	
4122.87D			T 069 7157	CHRYSLER	
	1337 34	PEUGEOT	T 069 7157	JEEP	
	273 480	VOLVO			
	77 00 657 955	RENAULT	4150.71D50	51.06402.0042	MAN
	77 00 703 136	RENAULT		51.06402.0052	MAN
	77 00 710 657	RENAULT		51.06402.0057	MAN
	77 01 349 173	RENAULT		51.06402.0062	MAN
	77 01 349 415	RENAULT		51.06402.0065	MAN
	79 102 461 13	PEUGEOT		51.06402.0068	MAN
4123.70			4150.79D50	51.06402.0034	MAN
	076 121 113 A	VOLKSWAGEN		51.06402.0043	MAN
				51.06402.0044	MAN
				51.06402.0049	MAN
				51.06402.0050	MAN
4123.80D				51.06402.0051	MAN
	005 203 29 75	MERCEDES-BENZ		51.06402.0053	MAN
	075 121 113 D	AUDI		51.06402.0056	MAN
	075 121 113 D	SEAT		51.06402.0061	MAN
	075 121 113 D	VOLKSWAGEN		51.06402.0064	MAN
	1 018 799	FORD		51.06402.0067	MAN
1 032 249	FORD		51.06402.0069	MAN	
4126.88			4150.83D50	51.06402.0058	MAN
	90048-33029-000	DAIHATSU		51.06402.0060	MAN
	90916-03043	TOYOTA		51.06402.0063	MAN
4137.80D				51.06402.0066	MAN
	004 203 39 75	MERCEDES-BENZ			
	004 203 40 75	MERCEDES-BENZ	4151.76D	44 00 106	OPEL
4144.82D	116 200 03 15	MERCEDES-BENZ		482 6602	FIAT
				50 00 816 924	RENAULT
	13 38 059	OPEL		9 108 106	GM
	13 38 062	OPEL		9 108 106	VAUXHALL
	90 410 665	GM			
4144.92D	90 443 473	GM	4151.79D	730 3174	FIAT
				730 3615	FIAT
	13 38 049	OPEL		730 3615	IVECO
	13 38 049	VAUXHALL			
	13 38 054	OPEL	4152.79D	471 6264	IVECO
90 232 012	GM				

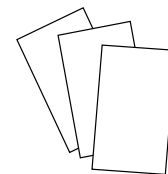

Wahler-ref.	Manufacturer's Ref.	Manufacturer	Wahler-ref.	Manufacturer's Ref.	Manufacturer
	480 7492	IVECO		9842 4854	IVECO
	483 1783	IVECO		9843 3497	IVECO
<b>4154.82D</b>	75 17 345	SAAB	<b>4166.79D</b>	480 4321	IVECO
	88 17 538	SAAB		9843 2310	IVECO
<b>4154.88D</b>	30 57 7561	SAAB		9846 7516	IVECO
	88 17 298	SAAB	<b>4168.92D</b>	13 38 060	OPEL
	88 22 025	SAAB		13 38 060	VAUXHALL
	91 66 687	SAAB		90 352 677	GM
	91 94 101	SAAB	<b>4174.79D</b>	45 00 823	OPEL
	91 94 242	SAAB		477 0246	IVECO
<b>4155.87D</b>	025 121 113 D	AUDI		482 3211	IVECO
	025 121 113 D	VOLKSWAGEN		483 7166	IVECO
	025 121 113 E	AUDI		77 01 042 512	RENAULT
	025 121 113 E	VOLKSWAGEN		809 6735	IVECO
	025 121 113 F	AUDI		9 161 123	GM
	025 121 113 F	VOLKSWAGEN		91 61 123	VAUXHALL
<b>4158.80D</b>	04778 975	CHRYSLER		9846 3637	FIAT
	13 38 466	OPEL		9846 3637	IVECO
	13 38 466	VAUXHALL	<b>4174.82D</b>	1338 90	CITROËN
	3 901 2004 F	VM		1338 90	PEUGEOT
	4778 975	CHRYSLER		5 0032 9622	FIAT
	7 072 643	FORD		50 032 9622	IVECO
	91 153 670	GM	<b>4175.92D</b>	13 38 067	OPEL
	91 153 670	VAUXHALL		13 38 067	VAUXHALL
	GTS 287	ROVER		13 38 084	OPEL
	PEL 10009 EVA	ROVER		13 38 084	VAUXHALL
	RTC 6673	LANDROVER		24 420 652	GM
<b>4160.83D</b>	6051 6212	ALFA ROMEO		45 03 017	SAAB
<b>4161.83</b>	928.106.129.06	PORSCHE		46 23 815	SAAB
	928.106.129.16	PORSCHE		90 410 897	GM
	928.106.129.17	PORSCHE		90 502 201	GM
<b>4162.79D</b>	6131 6592	IVECO	<b>4176.80D</b>	003 203 98 75	MERCEDES-BENZ
	6131 8373	IVECO		601 200 01 15	MERCEDES-BENZ
<b>4163.74D</b>	9849 2868	IVECO		602 200 00 15	MERCEDES-BENZ
	9849 2873	IVECO		603 200 00 15	MERCEDES-BENZ
<b>4163.79D</b>	9842 0718	IVECO	<b>4176.85D</b>	606 203 01 75	MERCEDES-BENZ
	9846 7517	IVECO		004 203 09 75	MERCEDES-BENZ
<b>4164.92D</b>	13 38 050	OPEL		0820117806	MULTICAR
	13 38 057	OPEL		601 200 00 15	MERCEDES-BENZ
	13 38 057	VAUXHALL		606 203 02 75	CHEVROLET
	13 38 063	OPEL		606 203 02 75	DAEWOO
	13 38 063	VAUXHALL	<b>4177.92D</b>	606 203 02 75	MERCEDES-BENZ
	90 220 435	GM		606 203 05 75	MERCEDES-BENZ
	90 354 822	GM		13 38 068	OPEL
	90 443 472	GM		13 38 068	VAUXHALL
<b>4165.79D</b>	473 8169	IVECO		90 411 948	CHEVROLET
				90 411 948	DAEWOO
				90 411 948	GM
				90 411 948	VAUXHALL

## Cross References

Wahler-ref.	Manufacturer's Ref.	Manufacturer	Wahler-ref.	Manufacturer's Ref.	Manufacturer	
4177.92D	92 063 300	GM	4223.75D	1 431 979	SCANIA	
	92 063 300	HOLDEN				
4178.92D	13 38 073	OPEL	4223.83D	1 358 995	SCANIA	
	13 38 073	VAUXHALL		1 404 924	SCANIA	
	90 412 901	GM		1 423 450	SCANIA	
4180.82D	13 38 069	OPEL	4224.75D	1 458 198	SCANIA	
	13 38 069	VAUXHALL				
	90 486 128	GM	4224.80D	1 347 594	SCANIA	
	92 061 279	DAEWOO		1 404 925	SCANIA	
				1 745 449	SCANIA	
4183.82D	13 38 080	OPEL	4231.80D	11 53 1 251 041	BMW	
	90 501 699	GM			11 53 1 254 065	BMW
4183.92D	13 38 079	OPEL	4232.71	11 53 1 265 086	BMW	
	13 38 079	VAUXHALL				
	90 501 081	GM	4232.80D	11 53 1 264 668	BMW	
4188.92D	13 38 087	OPEL		11 53 1 265 085	BMW	
	90 529 846	GM	4233.84D	003 203 82 75	MERCEDES-BENZ	
	90 529 846	VAUXHALL		116 200 02 15	MERCEDES-BENZ	
4189.87D	48 11 586	OPEL	4235.71D	11 53 1 466 174	BMW	
	92 062 728	CHEVROLET				
	92 062 728	DAEWOO	4235.80D	11 53 1 710 953	BMW	
	92 067 408	CHEVROLET		11 53 1 713 040	BMW	
	92 067 408	DAEWOO	4236.88D	11 53 1 721 002	BMW	
4193.92D	47 72 190	SAAB		11 53 1 721 003	BMW	
	9 543 786	GM		11 53 7 511 580	BMW	
4194.92D	13 38 478	OPEL	4236.92D	11 53 1 733 803	BMW	
	92 063 300	GM		11 53 7 511 083	BMW	
4198.92D	13 38 100	OPEL	4237.80D	11 53 1 727 145	BMW	
	90 572 899	GM			11 53 2 243 126	BMW
	90 572 899	VAUXHALL			11 53 2 244 151	BMW
					11 53 2 246 199	BMW
4201.92D	13 38 009	OPEL		13 38 076	OPEL	
	13 38 097	OPEL		13 38 076	VAUXHALL	
	24 435 781	GM		90 509 110	GM	
	24 435 781	VAUXHALL		90 509 110	VAUXHALL	
	90 573 926	GM	4237.88D	11 53 2 246 825	BMW	
	90 573 926	VAUXHALL				
4206.90D	272 335	VOLVO	4238.92D	11 53 1 712 043	BMW	
	9 125 406	VOLVO		11 53 1 743 528	BMW	
				11 53 1 743 542	BMW	
4207.92D	13 38 002	OPEL	4242.92D	13 38 003	OPEL	
	9 128 786	GM			9 129 907	GM
	91 28 786	VAUXHALL			91 29 907	VAUXHALL
4208.92D	13 38 331	OPEL	4246.80D	4652 5581	FIAT	
	90 573 326	GM				
	90 573 326	VAUXHALL	4247.80D	4646 6123	FIAT	

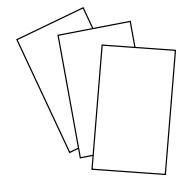

Wahler-ref.	Manufacturer's Ref.	Manufacturer	Wahler-ref.	Manufacturer's Ref.	Manufacturer	
4249.83D	996.106.013.54	PORSCHE	4256.92D50	6 058 444	FORD	
	996.106.013.55	PORSCHE		4264.84D	030 121 113	VOLKSWAGEN
	996.106.013.56	PORSCHE			030 121 113 B	AUDI
	996.106.013.57	PORSCHE			030 121 113 B	SEAT
	996.106.121.53	PORSCHE			030 121 113 B	VOLKSWAGEN
	996.106.125.52	PORSCHE			4264.87D	044 121 113
4253.87D	032 121 113	SKODA	044 121 113			SEAT
	032 121 113	VOLKSWAGEN	044 121 113	SKODA		
	056 121 113	SKODA	044 121 113	VOLKSWAGEN		
	056 121 113	VOLKSWAGEN	056 121 113 D	AUDI		
	068 121 113 H	AUDI	056 121 113 D	SEAT		
	068 121 113 H	SEAT	056 121 113 D	SKODA		
	068 121 113 H	SKODA	056 121 113 D	VOLKSWAGEN		
	068 121 113 H	VOLKSWAGEN	4269.78D	1 002 788	FORD	
4255.82D	08 966 483	GM		1 031 881	FORD	
	13 38 024	OPEL		1 096 699	FORD	
	13 38 024	VAUXHALL		4008540	MULTICAR	
4255.87D	08 966 485	GM		69015347	HAKO	
	08 966 485	VAUXHALL		95VW 8575 AB	FORD	
	13 38 033	OPEL	95VW 8575 AC	FORD		
	13 38 033	VAUXHALL	4270.88D	19300-PE0-013	HONDA	
4255.92D	13 38 038	OPEL		19300-PE0-024	HONDA	
	13 38 038	VAUXHALL		19300-PLZ-004	HONDA	
	90 067 918	GM	4272.90D	1 001 993	FORD	
	90 067 918	VAUXHALL		1 663 819	FORD	
4256.71	056 121 113 E	VOLKSWAGEN		6 153 501	FORD	
	068 121 113 A	VOLKSWAGEN		6 588 962	FORD	
4256.80D	056 121 113 A	AUDI		6 866 389	FORD	
		VOLKSWAGEN		89FF 8575 AA	FORD	
		CATERILLAR	89TM 8575 AA	FORD		
		CATERILLAR	928M 8575 AE	FORD		
		CATERILLAR	948M 8575 AA	FORD		
		CATERILLAR	4274.82D	271 417	VOLVO	
		CATERILLAR		271 664	VOLVO	
		CATERILLAR		74 31 397 947	RENAULT	
		CATERILLAR		74 36 842 409	RENAULT	
		CATERILLAR		74 39 180 811	RENAULT	
CATERILLAR	9 180 811	VOLVO				
4256.80D60	944.106.129.05	PORSCHE	4274.87D	077 121 113 C	AUDI	
	4256.83D60	037 121 113		VOLKSWAGEN	077 121 113 C	VOLKSWAGEN
944.106.019.00		PORSCHE	4274.87D	077 121 113	AUDI	
944.106.129.05		PORSCHE		077 121 113	SKODA	
4256.87D50	0 801 587	FORD		077 121 113	VOLKSWAGEN	
	6 100 372	FORD		077 121 113 B	AUDI	
	6 106 381	FORD		077 121 113 B	SKODA	
	6 124 378	FORD		077 121 113 B	VOLKSWAGEN	
	6 176 366	FORD		078 121 113	SKODA	
	84FF 8575 BA	FORD		078 121 113	VOLKSWAGEN	
	SE 021 032 221 B	SEAT		078 121 113 C	AUDI	



## Cross References

Wahler-ref.	Manufacturer's Ref.	Manufacturer	Wahler-ref.	Manufacturer's Ref.	Manufacturer
4274.87D	078 121 113 C	SKODA	4368.87	63 38 050	OPEL
	078 121 113 C	VOLKSWAGEN		7173 9800	FIAT
	078 121 113 F	AUDI			
	078 121 113 F	SKODA		311.00.06.0065	STEYR
	078 121 113 F	VOLKSWAGEN			
	078 121 113 J	AUDI		81.06401.6002	MAN
	078 121 113 J	SKODA			
	078 121 113 J	VOLKSWAGEN		4414.87D	111 200 17 15
4274.92D	078 121 113 G	AUDI	4428.92D	111 203 10 75	MERCEDES-BENZ
	078 121 113 H	AUDI		63 38 004	OPEL
4275.87D	00A 121 113	VOLKSWAGEN	4430.87D	070 121 114	VOLKSWAGEN
	111 200 09 15	MERCEDES-BENZ	4431.105D		
	111 203 02 75	MERCEDES-BENZ		13 38 178	OPEL
	111 203 06 75	MERCEDES-BENZ		24 405 922	GM
	111 203 08 75	MERCEDES-BENZ		24 405 922	VAUXHALL
		55 577 072		GM	
4276.87D	110 200 03 15	DAEWOO		55 577 072	VAUXHALL
	111 200 03 15	MERCEDES-BENZ		63 38 018	OPEL
	111 203 03 75	MERCEDES-BENZ		7174 4389	FIAT
4278.80D	119 200 00 15	MERCEDES-BENZ		7177 0832	FIAT
	119 203 01 75	MERCEDES-BENZ		9 698 4104	CHEVROLET
4279.87D	111 200 08 15	MERCEDES-BENZ	4433.92D	13 38 017	OPEL
	111 203 05 75	MERCEDES-BENZ		24 447 862	GM
4280.80D	603 203 04 74	MERCEDES-BENZ	4434.80D	24 447 862	VAUXHALL
	605 203 00 75	MERCEDES-BENZ		772 1399	FIAT
4280.85D	603 203 04 74	MERCEDES-BENZ	4436.80D		
	604 203 00 75	MERCEDES-BENZ		4446.83D	777 0236
4281.87D	112 200 00 15	MERCEDES-BENZ		1338 23	CITROËN
	112 203 02 75	MERCEDES-BENZ		1338 23	PEUGEOT
	5098 918 AA	CHRYSLER		17570-86CA0	SUZUKI
4297.92D				17670-66G00	SUZUKI
	13 38 015	OPEL		21215-13060-15	LADA
	24 420 728	GM		25511-29000	HYUNDAI
	24 420 728	VAUXHALL		77 00 868 274	RENAULT
4298.87D	112 200 01 15	MERCEDES-BENZ		77 01 038 494	RENAULT
	112 203 03 75	MERCEDES-BENZ		96 160 901	CITROËN
4309.92D			4447.80D	9616 0901 80	FIAT
	628 203 01 75	MERCEDES-BENZ		9616 0901 80	LANCIA
4326.97D	11 53 0 139 877	BMW		SU001-0223	TOYOTA
	11 53 1 436 823	BMW		1338 19	PEUGEOT
	11 53 1 437 040	BMW		1338 72	CITROËN
	11 53 7 509 227	BMW		1338 72	PEUGEOT
4337.105D			4447.85D	96 118 108	CITROËN
	11 53 7 510 959	BMW		96 272 785 80	PEUGEOT
4351.79	114 470	VALTRA		1338 13	PEUGEOT
	9 225 0 757 014 6	MWM		1338 71	CITROËN
4357.92D			4449.84D	1338 71	PEUGEOT
	24 435 102	SAAB		96 058 051	CITROËN
				96 272 814 80	PEUGEOT
				77 00 260 959	RENAULT

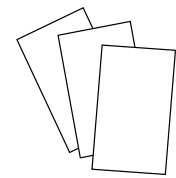

Wahler-ref.	Manufacturer's Ref.	Manufacturer	Wahler-ref.	Manufacturer's Ref.	Manufacturer
4450.83D	1338 39	CITROËN	4490.87D	642 200 02 15	MERCEDES-BENZ
	1338 39	PEUGEOT		642 200 20 15	MERCEDES-BENZ
	96 160 902 80	PEUGEOT	4508.105D	11 53 7 502 779	BMW
	9616 0902 80	FIAT		11 53 7 586 885	BMW
4450.89D	1338 26	CITROËN	11 53 7 586 885	ROLLS-ROYCE	
	1338 26	PEUGEOT	4516.70D	11 53 1 731 486	BMW
	96 108 092	CITROËN		4516.85D	11 53 1 710 056
	96 108 092 80	PEUGEOT	11 53 1 720 033		BMW
	96 108 093 80	PEUGEOT	11 53 1 720 306		BMW
4455.80D	022 121 113	AUDI	11 53 1 729 720	BMW	
	022 121 113	VOLKSWAGEN	11 53 1 729 841	BMW	
	955.106.113.00	PORSCHE	4517.87D	120 200 00 15	MERCEDES-BENZ
4457.82D	1 007 754	FORD		120 203 02 75	MERCEDES-BENZ
	1 211 553	FORD	4519.95D	11 53 1 702 279	BMW
	1 303 374	FORD		4520.75	1 395 856
	1E05-15-171 A	MAZDA	6 052 5 010 005 0		MWM
	96MM 8575 A1A	FORD	4520.80D		0303.191.04
	96MM 8575 BD	FORD		2 832 814	SCANIA
	96MM 8575 BE	FORD		283 281	SCANIA
4459.92D	12 992 692	GM		2871 591 M	KOMATSU
	13 38 096	OPEL		550 275	SCANIA
	13 38 096	VAUXHALL	609E060013	STEYR	
	63 38 028	OPEL	4529.70	00 24 774 033	RENAULT
	90 570 620	GM		4529.83D0	50 00 694 785
	90 570 620	VAUXHALL	4530.80		154.0943.426
4472.83D	005 203 59 75	MERCEDES-BENZ	4572.105D	2872 578 M	KOMATSU
	4480.82D	90916-03075		TOYOTA	738 0513
90916-03084		TOYOTA	4588.75/1	07Z 121 111	VOLKSWAGEN
90916-03125		TOYOTA		149 620	VALTRA
90916-03129		TOYOTA	9 229 8 757 004 6	MWM	
90916-03133		TOYOTA	4594.90D	11 53 1 704 704	BMW
90916-03136		TOYOTA		4596.83D	50 10 295 225
90916-03140		TOYOTA	4618.70		271990009-00
90916-03144		LEXUS		4618.82	27199003-00
90916-03144		TOYOTA	4619.75		005 203 17 75
90916-03145		LEXUS		1 661 993	VOLVO
90916-03145		TOYOTA		222730	PEGASO
90916-A3001		TOYOTA	770662	PEGASO	
90916-A3002		TOYOTA	4619.80	005 203 18 75	MERCEDES-BENZ
90916-A3003	TOYOTA	075 0562		DAF	
4483.82D	1 306 004	FORD	4488.80D0		
	1 712 228	FORD			
	30 711 624	VOLVO			
	4M5G 8575 ZA	FORD			
	4M5G 8575 ZB	FORD			
4488.80D0	07K 121 113 B	VOLKSWAGEN	4489.90D		
	3071 3572	VOLVO			

## Cross References

Wahler-ref.	Manufacturer's Ref.	Manufacturer	Wahler-ref.	Manufacturer's Ref.	Manufacturer
4619.80	11 53 1 312 288	BMW	4639.82D	17670-77E10	SUZUKI
	11 53 1 315 063	BMW		17670-77E11	SUZUKI
	295 024	DAF		1A51-15-171	MAZDA
	750 562	DAF		3 396 924	FORD
4619.82	1 544 683	VOLVO		3 599 763	FORD
	50 01 855 520	RENAULT		3 893 570	FORD
	8 149 182	VOLVO		3 902 514	FORD
4619.86	005 203 19 75	MERCEDES-BENZ		4 176 181	FORD
	1 665 694	VOLVO		4 188 498	FORD
	50 10 447 161	RENAULT		8AGX-15-171	MAZDA
	50 10 553 100	RENAULT		F42Z 8575 BA	FORD
	50 409 6443	IVECO		FS05-15-171	MAZDA
	8 149 186	VOLVO		KL01 15 171 A	FORD
	8929878	DETROIT DIESEL		KL01-15-171	MAZDA
	9943 1512	IVECO		KL01-15-171 A	MAZDA
4621.80D	11 53 1 318 274	BMW		XM34 8575 AA	FORD
			XM34 8575 AB	FORD	
4622.82D0	9849 8322	IVECO	4814.92D	06C 121 111 C	VOLKSWAGEN
		06C 121 111 D		VOLKSWAGEN	
		06C 121 111 E		VOLKSWAGEN	
4630.87D ▲	5175583AB	JEEP	4816.90D	3063 7217	VOLVO
	642 200 03 15	MERCEDES-BENZ		3065 0022	VOLVO
4634.76	21200-77A00	NISSAN		3077 7475	VOLVO
	21200-77A60	NISSAN		3129 3699	VOLVO
	21200-77A61	NISSAN	4817.90D	3063 7216	VOLVO
	21200-77A63	NISSAN		3065 0023	VOLVO
4637.76D	MD 164541	MITSUBISHI	3121 9205	VOLVO	
	MD 170031	MITSUBISHI	4818.90D	3065 0469	VOLVO
	MD 317015	MITSUBISHI		3077 7476	VOLVO
	MD 345617	MITSUBISHI		3129 3698	VOLVO
	ME 190303	MITSUBISHI	4820.87D	03G 121 111 A	AUDI
	ME 191593	MITSUBISHI		03G 121 111 A	SEAT
4637.82D	ME 200262	MITSUBISHI	03G 121 111 A	SKODA	
	30874021	VOLVO	03G 121 111 A	VOLKSWAGEN	
	30875350	VOLVO	03G 121 113 A	AUDI	
	MD 158570	MITSUBISHI	03G 121 113 A	SEAT	
	MD 165630	MITSUBISHI	03G 121 113 A	SKODA	
	MD 175746	MITSUBISHI	03G 121 113 A	VOLKSWAGEN	
	MD 310106	MITSUBISHI	4821.89D	1338 21	CITROËN
	MD 315301	MITSUBISHI		1338 21	PEUGEOT
	MD 335170	MITSUBISHI		1338 C8	PEUGEOT
	MD 337408	MITSUBISHI		21200-6F900	NISSAN
	MD 338234	MITSUBISHI		21200-6F901	NISSAN
	MD 360320	MITSUBISHI	96 006 231	CITROËN	
4638.76D	MD 997605	MITSUBISHI	GTS 299	ROVER	
			PEL 10019 EVA	ROVER	
4638.82D	MD 015299	MITSUBISHI	4825.98D	1 345 512	FORD
	MD 094120	MITSUBISHI		1 351 716	FORD
	MD 997224	MITSUBISHI		4M5G 6L721 GA	FORD
	MD 997606	MITSUBISHI		4M5G 6L721 GB	FORD
	ME 999295	MITSUBISHI			

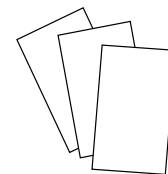

Wahler-ref.	Manufacturer's Ref.	Manufacturer	Wahler-ref.	Manufacturer's Ref.	Manufacturer		
4829.100D ▲	272 200 06 15	MERCEDES-BENZ		6 077 896	FORD		
	273 200 01 15	MERCEDES-BENZ		6 077 897	FORD		
	273 200 04 15	MERCEDES-BENZ		6 077 898	FORD		
				6 077 985	FORD		
4832.87D ▲	642 200 07 15	MERCEDES-BENZ		823 959 481 G	AUDI		
				823 959 481 G	SEAT		
4833.100D	272 200 05 15	MERCEDES-BENZ		823 959 481 G	SKODA		
	273 200 02 15	MERCEDES-BENZ		823 959 481 G	VOLKSWAGEN		
	6801 3949 AA	CHRYSLER		823 959 481 H	SKODA		
4834.100D	272 200 00 15	MERCEDES-BENZ		823 959 481 H	VOLKSWAGEN		
	272 200 01 15	MERCEDES-BENZ		823 959 481 K	SKODA		
	272 200 04 15	MERCEDES-BENZ		823 959 481 K	VOLKSWAGEN		
4835.87D	642 200 02 15	MERCEDES-BENZ		90 108 636	GM		
	642 200 04 15	MERCEDES-BENZ		90 108 636	VAUXHALL		
6010.75D	113 095 075	SKODA		95 26 518	SAAB		
	217.87.71	STEYR		595 1985	FIAT		
	84247900	INTER. HARV. IHC		595 1987	FIAT		
6010.88D	115 095 070	SKODA		6016.92			
	547 4546	FIAT					
	5474546	CITROËN					
	5474546	PEUGEOT					
	6 144 361	FORD					
85 47 572	SAAB						
6010.92D	113 095 090	SKODA			6017.95D	191 959 481 A	AUDI
	2828 6103	FIAT				191 959 481 A	SEAT
	411 4572	FIAT				191 959 481 A	VOLKSWAGEN
	423 5333	FIAT				191 959 481 C	AUDI
	423 5533	FIAT				191 959 481 C	SEAT
	424 0878	FIAT				191 959 481 C	VOLKSWAGEN
	426 3597	FIAT				251 959 481	AUDI
	823 959 481	AUDI				251 959 481	SEAT
	823 959 481	SEAT				251 959 481	VOLKSWAGEN
	823 959 481	VOLKSWAGEN				321 959 481 A	AUDI
	823 959 481 A	AUDI				321 959 481 A	SEAT
	823 959 481 A	SEAT				321 959 481 A	VOLKSWAGEN
	823 959 481 A	VOLKSWAGEN				321 959 481 C	AUDI
	823 959 481 F	AUDI				321 959 481 C	SEAT
	823 959 481 F	SEAT				321 959 481 C	VOLKSWAGEN
	823 959 481 F	VOLKSWAGEN				321 959 481 C	VOLKSWAGEN
	823 959 481 L	AUDI				321 959 481 D	AUDI
	823 959 481 L	SEAT	321 959 481 D			SEAT	
	823 959 481 L	VOLKSWAGEN	321 959 481 D			VOLKSWAGEN	
	85 69 23	SAAB	441 044 330 186			SKODA	
944.606.481.00	PORSCHE	6U0 959 481 A	AUDI				
6010.95D	13 41 002	OPEL	6U0 959 481 A		SEAT		
	13 41 002	VAUXHALL	6U0 959 481 A		VOLKSWAGEN		
	426 3997	AUTOBIANCHI					
	434 0878	FIAT	SE 021 952 600 A	SEAT			
	6 072 016	FORD					
	6 077 895	FORD					
		6020.92D					
		6020.95D					
		6024.95D					
			191 959 481 B	AUDI			
			191 959 481 B	SEAT			
			191 959 481 B	VOLKSWAGEN			
			321 959 481 B	VOLKSWAGEN			
			321 959 481 E	AUDI			
			321 959 481 E	VOLKSWAGEN			
			321 959 481 G	VOLKSWAGEN			
			811 959 481	AUDI			
			811 959 481	VOLKSWAGEN			
			893 959 481	AUDI			
			893 959 481	VOLKSWAGEN			

## Cross References

Wahler-ref.	Manufacturer's Ref.	Manufacturer
-------------	---------------------	--------------

6031.100D	13 41 011	OPEL
	13 41 011	VAUXHALL
	90 242 277	GM
	90 242 277	VAUXHALL
6031.105D	13 41 017	OPEL
	13 41 017	VAUXHALL
	90 277 288	GM
	90 277 288	VAUXHALL
6031.88D	1264 50	PEUGEOT
	13 0707 7080	FIAT
	13 41 028	OPEL
	13 41 028	VAUXHALL
	90 357 303	GM
	90 357 303	VAUXHALL
6031.92D	1264 32	PEUGEOT
	1264 50	PEUGEOT
	599 2746	FIAT
	6056 4101	FIAT
	6080 8223	FIAT
	774 8867	FIAT
	8242 0013	FIAT
	8243 6410	FIAT
	8246 5533	FIAT
	8247 7919	FIAT
907 0701	FIAT	
6031.97D	4652 0219	FIAT

# Gasket

Wahler-ref.	Gasket	Wahler-ref.	Gasket	Wahler-ref.	Gasket
100456D5	100456	3119.88D5	100601	4038.71D	104224
102543D5	102543		100607	4038.76D	104224
110156D5	110156	3119.92D3	100599	4038.81D	104224
110392D5	110392		100600	4049.80D	002085
115600D5	115600	3136.82D50	002154	4049.80D1	002479
117385D5	117385		105433	4049.87D	002085
3004.82D1	002149	3136.88D50	002154	4064.75D	002085
3004.88D1	002149		105433	4078.65D	002085
3004.92D1	002149	3141.87D	002138	4078.71D	002085
3017.87D2	003187	3142.90D	102642	4078.75D	002085
3017.87D50	002137	3143.87D	102725	4078.79D	002085
	002150	3145.79D	108476	4078.87D	002085
3017.92D2	003187	3146.90D	102642	4078.92D	002085
3017.92D50	002137	3151.87D	003062	4083.83D50	002892
	002150	3159.82D	003594		002922
3021.88D50	002153	3163.88D	104360	4088.80D	002085
	002163	3164.88	104360	4088.87D	002085
	002164	3166.89D	105317	4089.71D	003192
	002523	3167.83D	102725	4089.82D	003192
3021.92D50	002153	3169.79D	119164	4089.87D	003192
	002163	3171.82D	119081	4089.92D	003192
	002164	3174.89D	105571	4091.82D	116692
	002523	3300.80D	104361		116693
3023.87D	002160	3301.80D	104361	410007.87D	003588
3033.78D	120675	3302.80D	104361	410048.88D	109953
3033.84D	120675	3355.80D	003587	410049.88D	109944
3044.90D1	100595	3356.80D	003590	410055.87D	114270
3054.87D50	002143	3360.87D	003588		114365
	002153	3361.87D	003588	410058.84D	114419
3054.92D50	002143	3373.80D	003587	410075.79D	119164
	002153	3383.87	108485	410081.79D	119164
3091.92D	002137	3431.80D	104361	410090.88D	112151
3100.88D	102511	3457.90D	114432	410131.88D	102511
3100.92D	102511		114433	410171.87D	104738
3103.79	003602	3466.89D	105414	410174.92D	104738
3105.87D	003062	3467.85D	114595	410178.82D	114229
3109.82D	003592	3469.91D	105414	410181.82D	115702
3109.87D	003592	3470.89D50	105434	410183.82D	118938
3116.82D	120392		105435		118939
3116.89D	120392	3472.87D	002138	410183.88D	118938
3118.82D1	100596	3477.88D	115864		118939
	100597	3478.82D	115422	410201.80D	115864
	100606	3481.88D	104360	410224.78D	115423
3118.88D1	100596	3484.87D	108485	410224.82D	115423
	100597	3485.87D	108485	410228.82D	100596
	100606	3498.88D	100599	410230.78D	116903
3118.92D1	100596	3499.82D	100599	410262.91D	114731
	100597	3499.88D	100599	410263.91D	114731
	100606	4006.82D	002138	410289.81D	120389
3119.82D3	100599	4007.80D	110991	4103.82D	115422
	100600	4008.74D	003594	410348.82D	117136
3119.82D4	100605	4008.79D	003594		118913
3119.82D5	100601	4022.82D	003192	410352.82D	100599
	100607	4022.82D1	003595	410352.88D	100599
3119.88D3	100599	4022.88D	003192	410389.103D	116490
	100600	4022.92D	003192		118342
3119.88D4	100605	4033.82D	002144	410475.80D	102725
		4038.65D	104224	410475.87D	102725

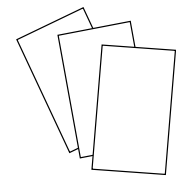

<b>Wahler-ref.</b>	<b>Gasket</b>	<b>Wahler-ref.</b>	<b>Gasket</b>	<b>Wahler-ref.</b>	<b>Gasket</b>
410488.88D	003192	4115.92D	002900	4201.92D	104892
4105.65D	002892	411545.82D	115864	4206.90D	100928
4105.71D	002892	4116.87D1	102081		101313
4105.75D	002892	4117.80D	002085	4207.92D	104892
4105.79D	002892	411715.84D	116903	4208.92D	102543
4105.83D	002892	411716.88D	116903	4223.75D	122689
410513.88D	003123	411743.82D	116903	4223.83D	122689
410514.88D	003123	4122.87D	002898	4224.75D	122690
410515.88D	003123	4123.80D	102081	4224.80D	122690
410516.88D	003123	4132.74D	002817	4231.71D	002140
410537.92D	002138	4137.71D	002085	4231.80D	002140
410590.88D	003123	4137.80D	002085	4231.84D	002140
410608.86D	118996	4144.82D	101973	4232.80D	002085
	119078	4144.92D	101973	4233.80D	002430
	119080	4147.80D	002898	4233.84D	002430
	120213	4150.71D50	002892	4235.71D	002085
	4619.86		106244	4235.75D	002085
410692.71D	119879	4150.79D50	002892	4235.80D	002085
	119880		106244	4236.88D	002085
410758.83D	120299	4150.83D50	002892	4236.92D	002085
	4596.83		106244	4237.80D	002085
410763.82D	003896	4151.76D	120392	4237.88D	002085
	120329	4151.79D	120392	4238.92D	002085
	120330	4152.79D	002817	4242.92D	102543
	4622.82D0	4154.82D	003192	4246.80D	104361
410765.90D	120222	4154.88D	003192	4247.80D	104361
410806.88D	120763	4155.87D	102081	4249.71D	106281
410808.88D	120763	4158.80D	002817	4249.83D	106281
410828.82D	121904	4160.83D	003052	4253.87D	002138
	122345	4162.79D	120392	4255.82D	003561
410828.86D	121904	4163.74D	002817	4255.87D	003561
	122345	4163.79D	102226	4255.92D	003561
410845.87D	120086	4164.92D	101973	4256.80D	002138
410845.92D	120086	4165.79D	102226	4256.80D60	000232
410871.80D	112151	4166.79D	002817		003602
	127334		102226	4256.83D60	003602
410937.82D	119081	4168.92D	101973		120392
410989.80D	124401	4174.79D	003595	4256.87D50	002138
410989.87D	124401		120392		002147
410994.88D	003123	4174.82D	003595		002148
411004.80D	122690		120392	4256.92D50	002138
411045.82D	121908	4174.88D	003595		002147
411133.80D	123872		120392		002148
	123873	4175.92D	100008	4264.84D	002138
	4619.80	4176.70D	002584	4264.87D	002138
411135.83D	123747	4176.75D	002584	4269.78D	115423
	123748	4176.80D	002584	4270.88D	102511
	411089.83D	4176.85D	002584	4272.90D	003192
411135.87D	123747	4177.92D	100007	4274.82D	102081
	123748	4178.92D	101973	4274.87D	102081
	411089.87D	4180.82D	101973	4274.92D	102081
411186.87D	120086	4183.82D	100007	4275.87D	002085
	127069	4183.92D	100007	4276.87D	002085
	127070	4188.92D	104892	4278.80D	102084
411187.87D	120086	4189.87D	100007	4279.87D	002085
	127069	4193.92D	104892	4280.80D	003650
	127070	4194.92D	100007	4280.85D	003650
4112.79D	002892	4198.92D	104892	4281.87D	003658

# Gasket

Wahler-ref.	Gasket	Wahler-ref.	Gasket	Wahler-ref.	Gasket
4297.92D	104892	6010.88D	002358	7187D	101561
4298.87D	003658	6010.92D	002358		115600
4309.92D	101642	6010.95D	002358	7188D	115599
4357.92D	104385	6017.85D	002358	7206D	101541
4414.87D	002085	6017.95D	002358		117943
4428.92D	104892	6020.92D	002358		117944
4430.87D	115028	6020.95D	002358	7211D	115599
4431.105D	104385	6024.95D	002358	7220D	117943
4433.92D	104892	6031.100D	002358		117944
4434.80D	104361	6031.105D	002358	7223D	110156
4436.80D	104361	6031.88D	002358	7234D	115618
4446.83D	105410	6031.92D	002358		115619
4447.80D	002898	6031.97D	002358	7241D	100456
4447.85D	002898	60347D	123800		115600
4449.84D	002898		123801	7256D	120620
4450.83D	105410	6035.92D	002358	7268D	111127
4450.89D	105410	60364D	117385		117420
4455.80D	102081	6037.81D	002358		117421
4457.82D	105686	6037.87D	002358	7271D	103995
	106503	6037.95D	002358		115600
4459.92D	102322	60375D	115586	7283D	100456
4472.83D	002892	6039.95D	002358	7293D	100456
4480.82D	114229	60409D	115600	7294D	100456
4483.82D	106307		117385		115600
	106503	60415D	123800		117385
4489.90D	108431	60579D	126105	7301D	117385
4490.87D	117217	60595D	101541	7327D	110156
4508.105D	100532		102241		115600
4516.70D	104887		117943		117385
4516.85D	104887	60633D	115600	7350D	118533
4517.87D	002085		117385	7353D	103046
4519.95D	104887	60700D	115600	7371D	110156
4520.80D	104470		117385		115600
4572.105D	120626	60702D	115600	7372D	110156
4594.90D	003562		117385		115600
4596.83D	120298	60777D	115600D5		117385
4621.80D	101216		117385	7375D	115593
4630.87D	117217	6087.87D	002358	7389D	103046
4638.76D	111209	61010D	115600	7396D	121743
4638.82D	111209	61384D	117385		121747
4814.92D	103394	665104D	115600D5	7451D	110156
4816.90D	114704	665574D	100456		117385
4817.90D	114704		102543	7496D	102543
4818.90D	114704		110156		110156
4820.87D	002138		110392		115600
4821.89D	109319		115600	7497D	118533
4829.100D	110657		117385		118534
4832.87D	114270	710023D	103046	7504D	110221
	117217	710073D	110221	7523D	118530
4833.100D	110657	710095D	106306	7527D	106306
4834.100D	110657	710327D	103386	7529D	110392
	111203	710476D	123589	7545D	108551
4835.87D	117217	710559D	127104	7556D	108056
6010.100D	002358	710571D	110392	7557D	108056
6010.70D	002358	710572D	110392	7574D	117948
6010.75D	002358	710574D	115600		126163
6010.82D	002358		127082	7610D	123590
6010.85D	002358	7159D	115586	7625D	103046



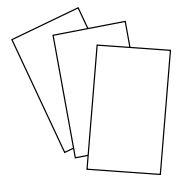

<b>Wahler-ref.</b>	<b>Gasket</b>
--------------------	---------------

<b>7631D</b>	118493 118532 118533
--------------	----------------------------

<b>7645D</b>	106306
--------------	--------

<b>7649D</b>	101953 115600
--------------	------------------

<b>7650D</b>	101953 117385
--------------	------------------

## Supersession List

Wahler-ref.

Gasket

Wahler-ref.

Gasket

**003602** 120392  
**100928** 120389  
**104360** 003123  
**115600** 115600D5  
**117385** 117385D5  
**2383.75** 2391.75  
**3000.70** 3000.75  
**3004.88** 3004.88D1  
**3021.88** 3021.88D50  
**3029.72** 3029.78  
**3033.78** 3033.78D  
**3033.84** 3033.84D  
**3044.90** 3044.90D1  
**3053.72** 3053.75  
**3053.78** 3053.75  
**3054.92D** 3054.92D50  
**3118.82** 3118.82D1  
**3118.88** 3118.88D1  
**3118.92** 3118.92D1  
**3119.92** 3119.92D3  
**3347.80** 3343.80D  
**3391.92D** 4459.92D  
**4069.75/1** 4083.79  
**4083.71** 4105.71D  
**4083.71D1** 4105.71D  
**4083.79** 4105.79D  
**4083.83** 4105.83D  
**4089.87** 4089.87D  
**4089.92** 4089.92D  
**4091.82** 4091.82D  
**410044.82D** 410231.82D  
**410069.82D** 410937.82D  
**410176.82** 410176.82D0  
**410176.88** 410176.88D0  
**4103.82** 4103.82D  
**410695.105D** 411059.105D  
**4112.79D** 4150.79D50  
**4116.87D** 4116.87D1  
**4160.83** 4160.83D  
**4165.79** 4165.79D  
**4166.79** 4166.79D  
**4238.92D** 4236.92D  
**4269.78** 4269.78D  
**4340.80** 4341.80  
**4371.80** 4351.79  
**4378.80** 4341.80  
**4379.80** 4351.79  
**4417.81D** 410289.81D  
**4453.87D** 410171.87D  
**4488.80** 4488.80D0  
**4523.75** 4520.75  
**4523.80** 4520.80D  
**4546.80** 4565.80  
**4546.80** 4565.80/2  
**4547.70** 4565.70  
**4547.80** 4565.80  
**4547.80** 4565.80/2

**4565.80** 4565.80/2  
**4570.80** 4684.80/1  
**4596.83** 4596.83D  
**4622.82** 4622.82D0  
**4663.80/1** 410864.79D0  
**4665.80/1** 4684.80/1  
**4684.70/1** 410864.71D0  
**4684.80/1** 410864.79D0  
**4684.83/1** 410864.83D0  
**4689.97** 4689.97D0  
**4689.97D0** 410086.97D0  
**6035.92** 6035.92D

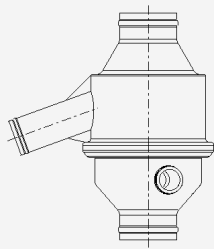
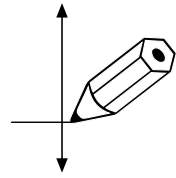

Typ  
2389

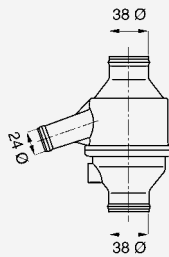

Typ  
2391  
2394

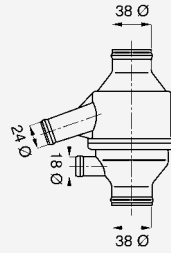

Typ 2393

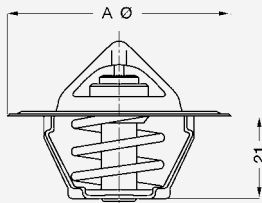

Typ A  
3000 54 mit Entlüftungskerbe  
3021 48  
3044 44  
3136 53,5  
3141 54 ohne Entlüftungskerbe  
3167 54 gummibeschichtete Ventilplatte

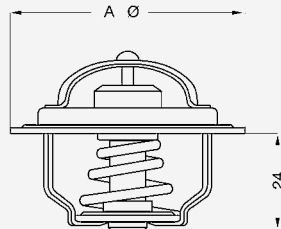

Typ A  
3004 54 mit Entlüftungsventil  
3032 60 mit Entlüftungsventil  
3061 57 mit Entlüftungsventil  
3063 53,5 mit Entlüftungskerbe

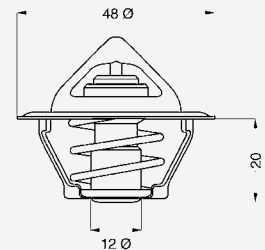

Typ 3017 mit Entlüftungskerbe  
3091 mit Entlüftungsventil und gummibeschichteter Ventilplatte  
3082 gummibeschichtete Ventilplatte

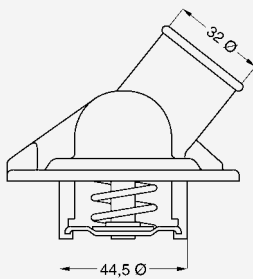

Typ 3022

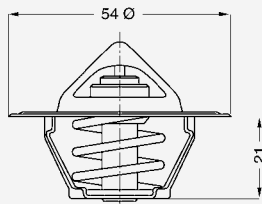

Typ 3023 mit Entlüftungskerbe

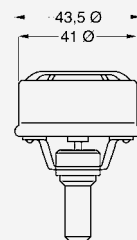

Typ 3029

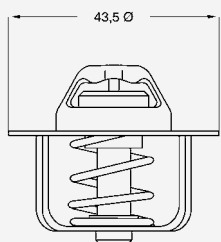

Typ 3033

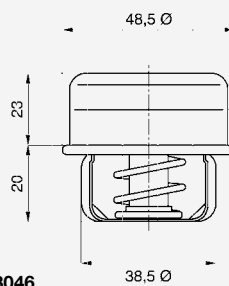

Typ 3046

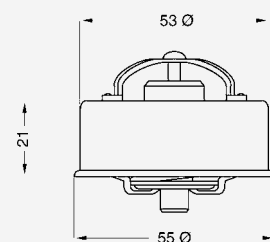

Typ 3053

# Assembly dimensions

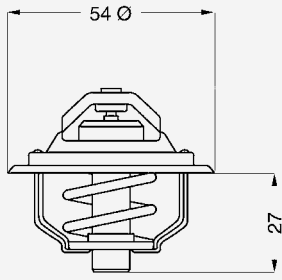

Typ 3054

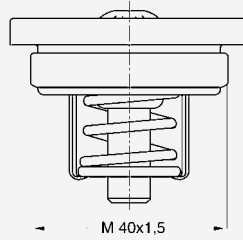

Typ 3067

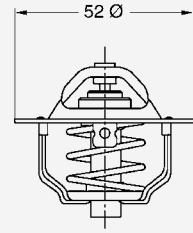

Typ 3100

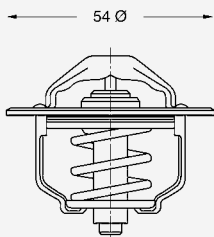

Typ 3103 mit Entlüftungsventil

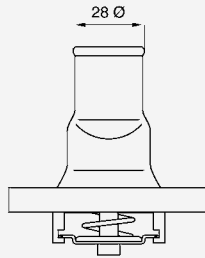

Typ 3105

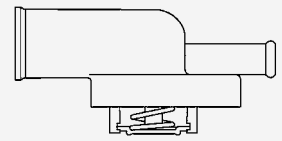

Typ 3109

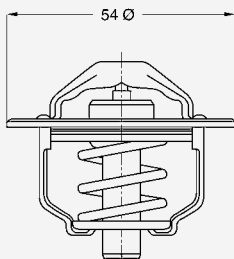

Typ 3116 mit Entlüftungsventil

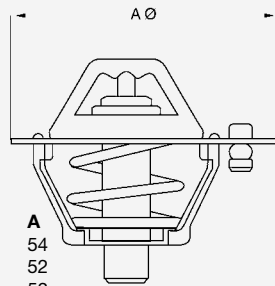

Typ	A
3118	54
3119	52
3499	52

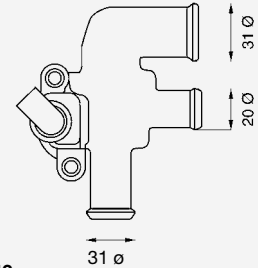

Typ 3142

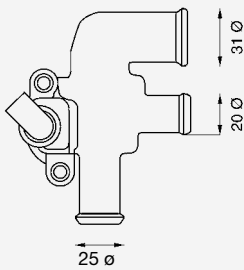

Typ 3146

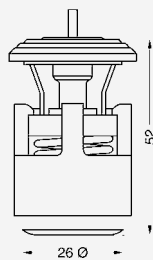

Typ 3143

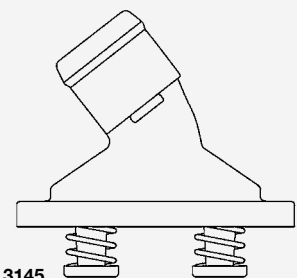

Typ 3145

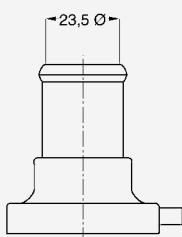

Typ 3151

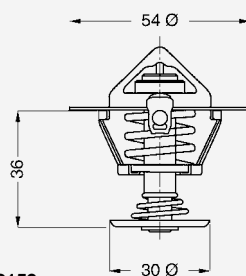

Typ 3159

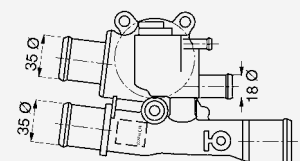

Typ	
3163	mit M 12 x 1,5
3481	mit M 12 x 1,5 / M 16 x 1,5

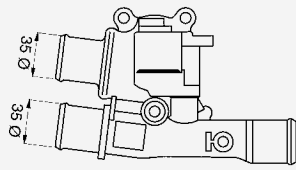
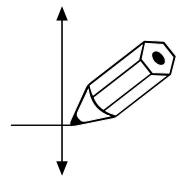

Typ 3164

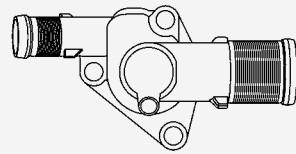

Typ 3166

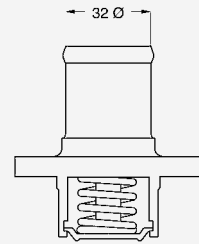

Typ 3174

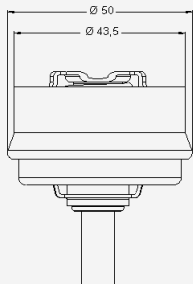

Typ 3187

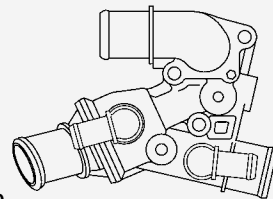

Typ  
3300  
4434 mit M22 x 1,5  
4436 mit M16 x 1,5

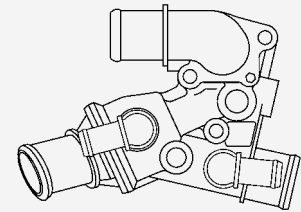

Typ  
3301 mit 2 x M16 x 1,5  
3302 mit 1 x M16 x 1,5

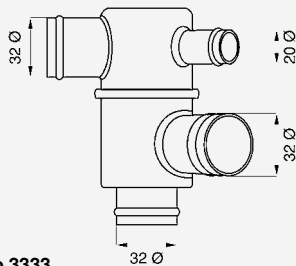

Typ 3333

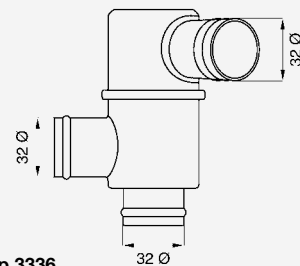

Typ 3336

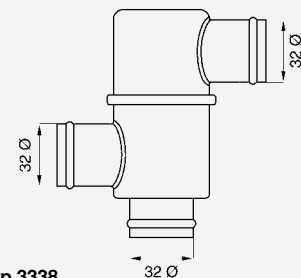

Typ 3338

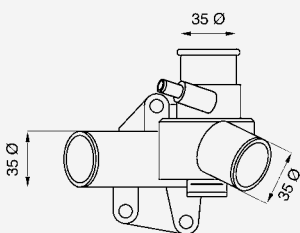

Typ  
3343 21 Ø  
3347 16,8 Ø

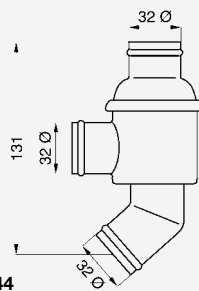

Typ 3344

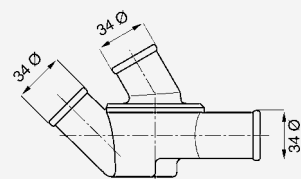

Typ 3345

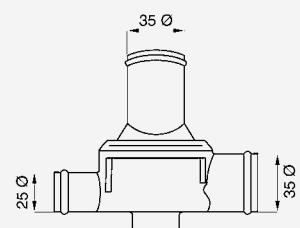
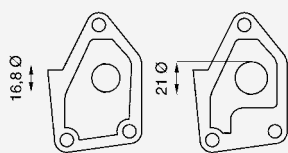

Typ 3352

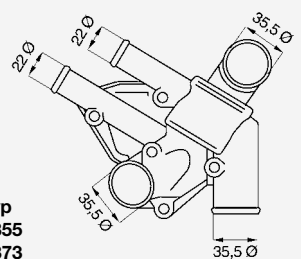

Typ  
3355  
3373  
3378

# Assembly dimensions

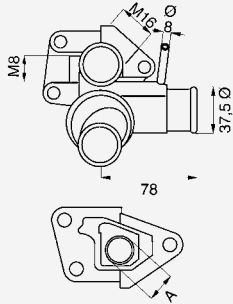

**Typ A**  
**3356** 21, mit M 16, ohne M8, mit Ø 8  
**3364** 23, ohne M 16, ohne M8, ohne Ø 8  
**3366** 21, mit M 16, mit M8, mit Ø 8

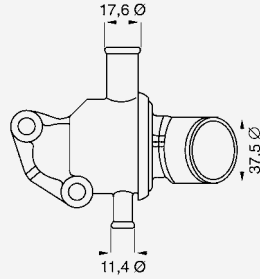

**Typ 3361**  
**3360** Stützen am Deckel um 90° gedreht

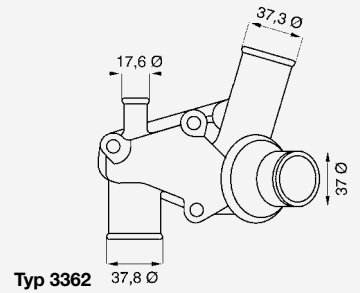

**Typ 3362**

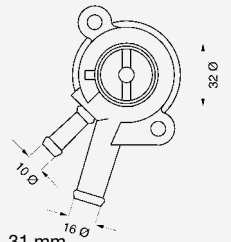

**Typ 3383** mit Ø 10, 31 mm  
**3484** mit Ø 10, 51 mm  
**3485** ohne Ø 10

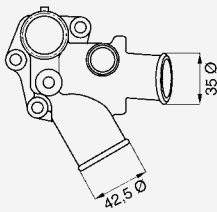

**Typ 3431**

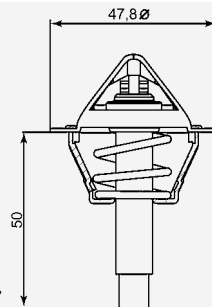

**Typ 3457**

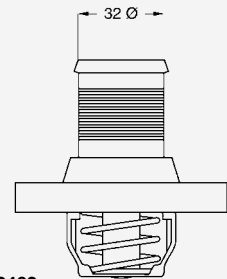

**Typ 3463**

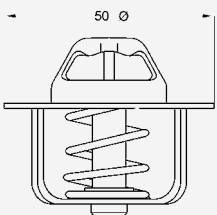

**Typ 3466**

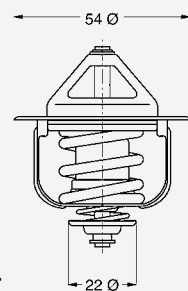

**Typ 3467**

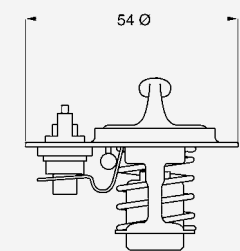

**Typ 3468**

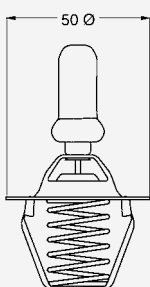

**Typ 3469**

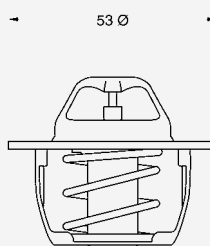

**Typ 3470**

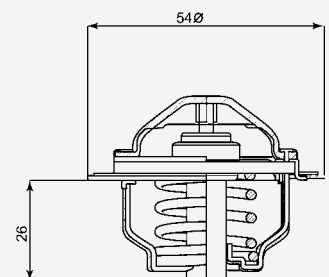

**Typ 3472**

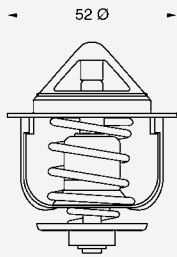
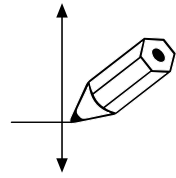

Typ 3477

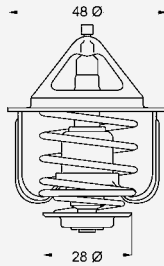

Typ 3478

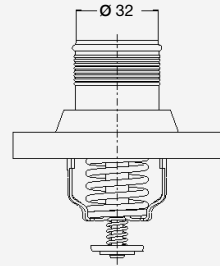

Typ 3483

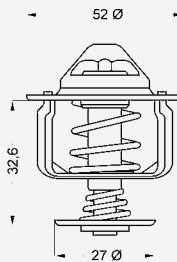

Typ 3497

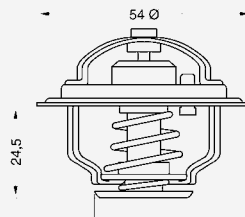

Typ  
4003 ohne Entlüftungsventil oder -kerbe  
4008 mit Entlüftungsventil  
4015 mit Entlüftungsventil

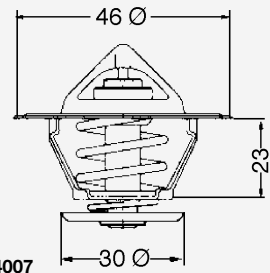

Typ 4007

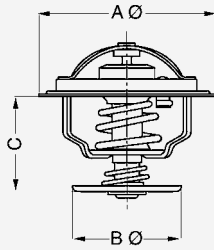

Typ	A	B	C	
4006	54	35	33	mit Entlüftungsventil
4026	54	28	30	mit Positionskerbe
4029	54	29	32	mit Entlüftungsventil
4033	56	34	33	ohne Entlüftungsventil oder -Kerbe
4154	54	29	32	mit Entlüftungsventil
4253	54	35	31	Ventilteller gummi-beschichtet
4256	54	35	31	ohne Entlüftungsventil oder -Kerbe
4272	54	35	31	mit Entlüftungsventil

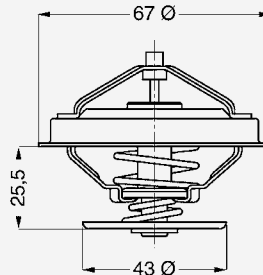

Typ	
4030	mit Entlüftungskerbe
4059	
4064	mit Entlüftungsventil kühlenseitig
4078	mit Entlüftungsventil motorseitig
4083	mit Entlüftungskerbe
4112	mit Entlüftungsventil
4122	mit Entlüftungsventil
4158	mit Entlüftungsventil

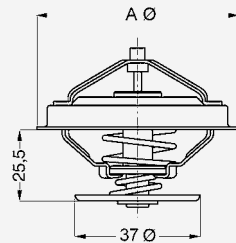

Typ	A	B	
4049	67	37	ohne Entlüftungsventil oder -kerbe
4088	67	37	ohne Entlüftungsventil oder -kerbe
4132	75	43	mit Entlüftungskerbe
4116	67	37	Ventilteller gummi-beschichtet
4117	67	37	mit Entlüftungskerbe

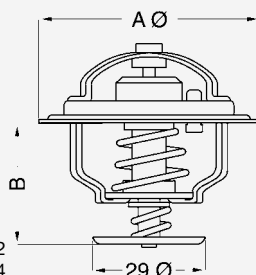

Typ	A	B
4022	54	32
4126	52	34
4154	54	32

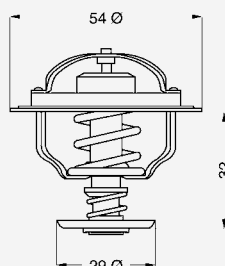

Typ 4038

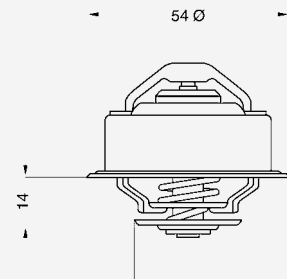

Typ 4089

# Assembly dimensions

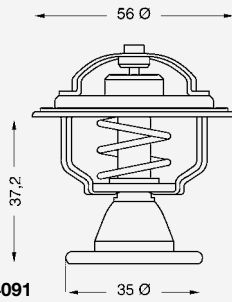

Typ 4091

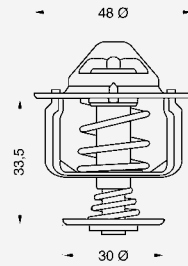

Typ 4103

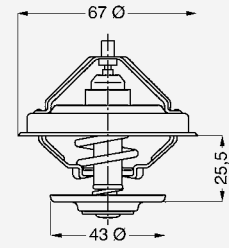

Typ 4105

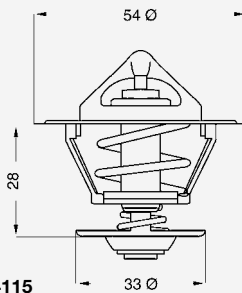

Typ 4115

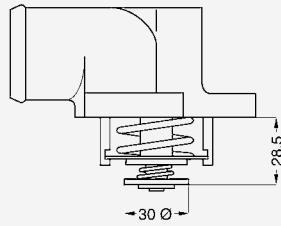

Typ 4135

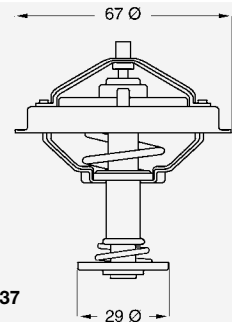

Typ 4137

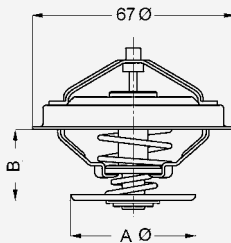

Typ	A	B
4123	37	25,5 mit Entlüftungsventil
4155	33	22,5
4161	50	25,5 mit Entlüftungskerbe
4274	35	25,5 mit Entlüftungsventil

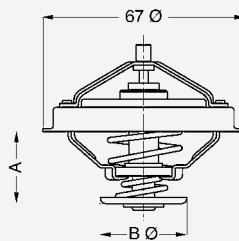

Typ	A	B
4142	25	29 mit Entlüftungsventil
4147	25,5	29 ohne Entlüftungsventil
4237	26	35 mit Entlüftungsventil
4455	25,5	35 mit Entlüftungsventil

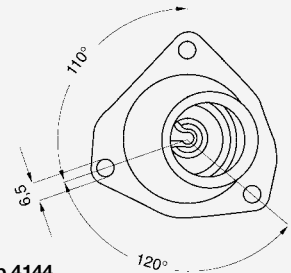

Typ 4144

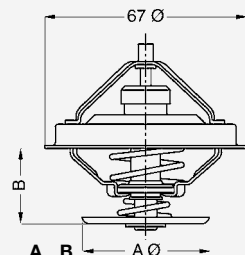

Typ	A	B
4150	43	25,5 mit Entlüftungsventil
4163	43	25 mit Entlüftungsventil

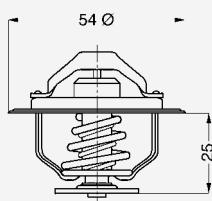

Typ 4151 mit Entlüftungsventil  
4174 gummibeschichtete Ventilplatte

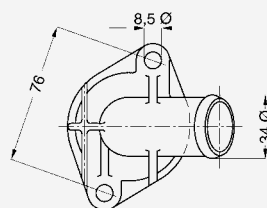

Typ 4160

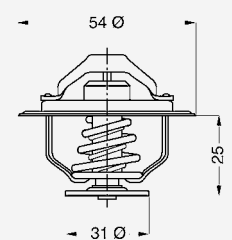

Typ 4162



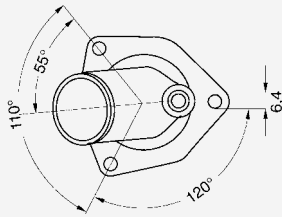
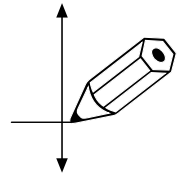

Typ 4164

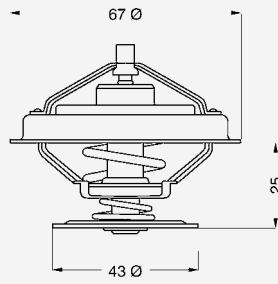

Typ 4165  
mit Entlüftungsventil

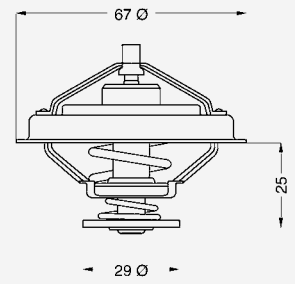

Typ 4166  
mit Entlüftungsventil

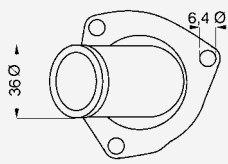

Typ 4168

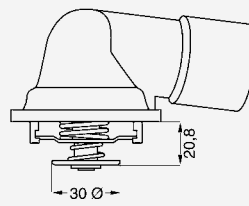

Typ 4175

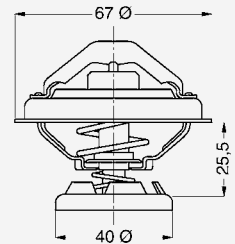

Typ 4176

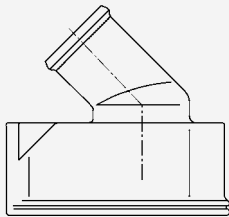

Typ 4177

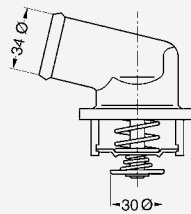

Typ 4178

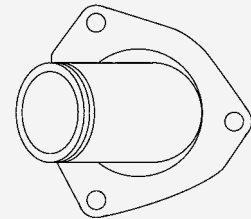

Typ 4180

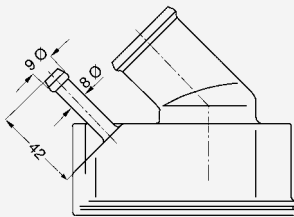

Typ 4183

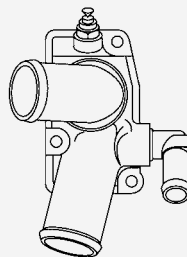

Typ 4188

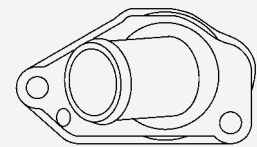

Typ 4189

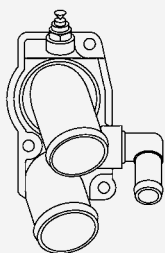

Typ 4193

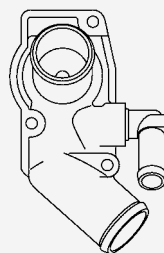

Typ 4198

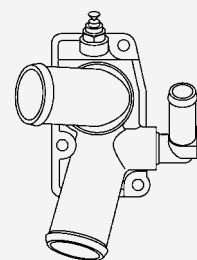

Typ 4201

# Assembly dimensions

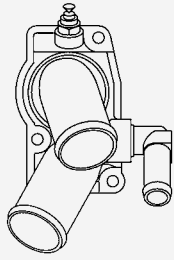

Typ 4207

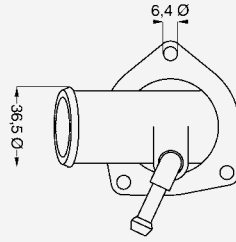

Typ 4208

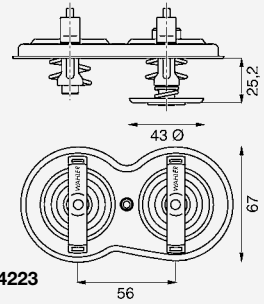

Typ 4223

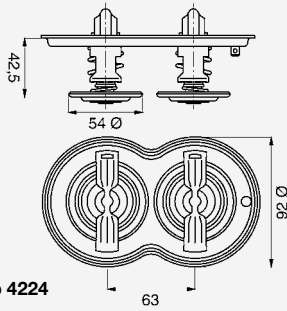

Typ 4224

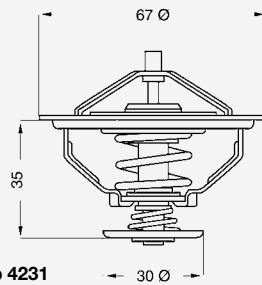

Typ 4231

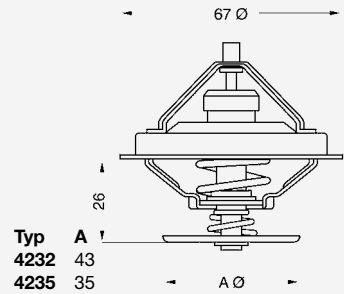

Typ A  
4232 43  
4235 35

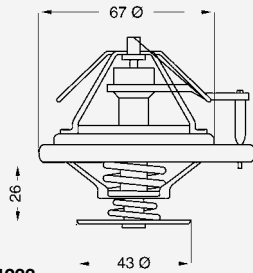

Typ 4233

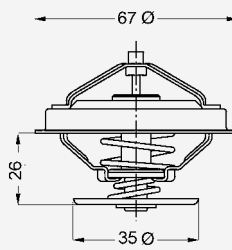

Typ 4236

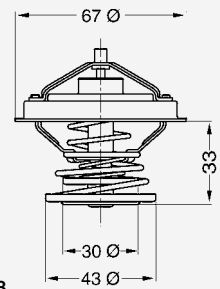

Typ 4238

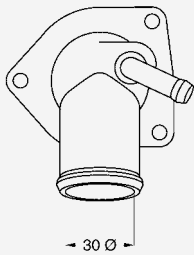

Typ 4242

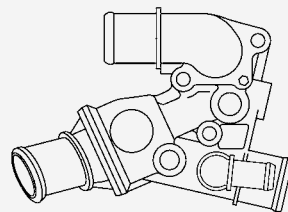

Typ 4246

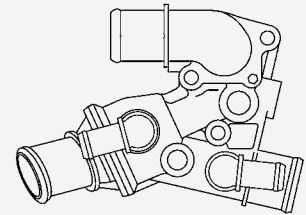

Typ  
4247 mit M 16 x 1,5 / M 22 x 1,5  
4434 mit M 16 x 1,5  
4436 mit M 16 x 1,5 / M 16 x 1,5

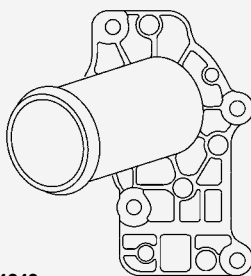

Typ 4249

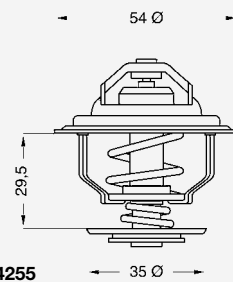

Typ 4255

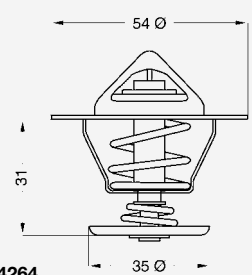

Typ 4264

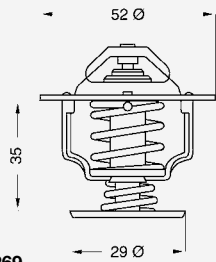
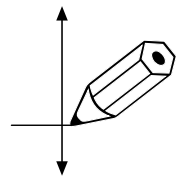

Typ 4269

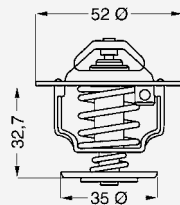

Typ 4270

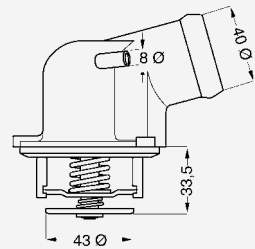

Typ 4275

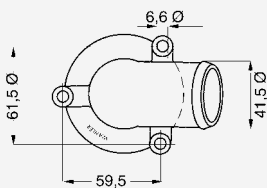

Typ 4276

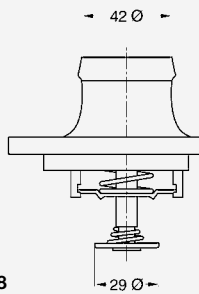

Typ 4278

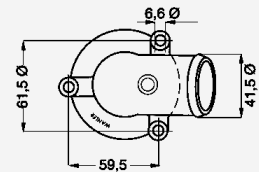

Typ 4279

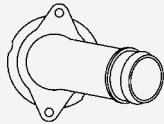

Typ 4280

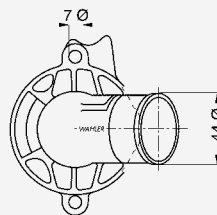

Typ 4281

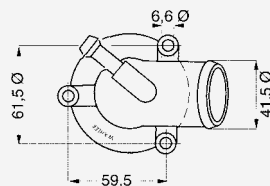

Typ 4286

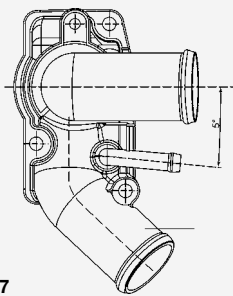

Typ 4297

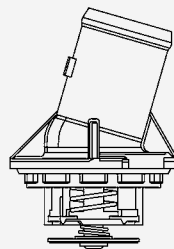

Typ 4298

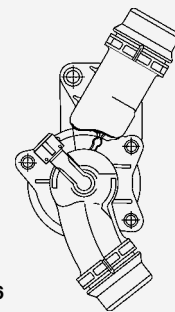

Typ 4326

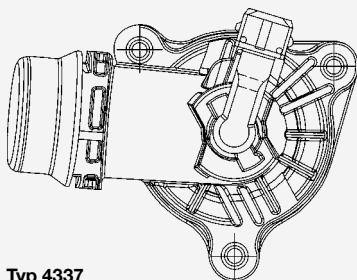

Typ 4337

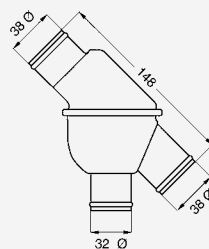

Typ 4341

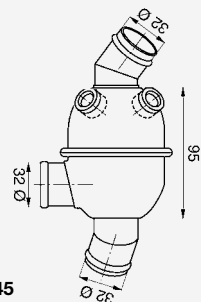

Typ 4345

# Assembly dimensions

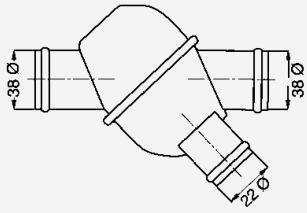

Typ 4351

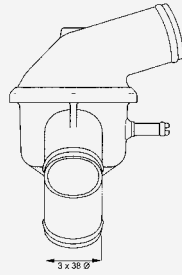

Typ 4368

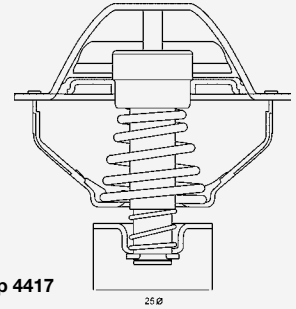

Typ 4417

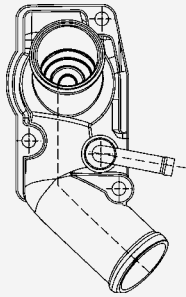

Typ 4433

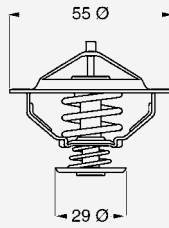

Typ 4446

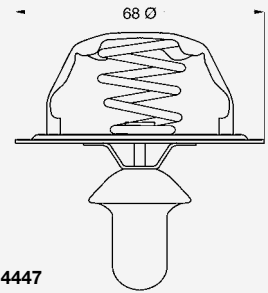

Typ 4447

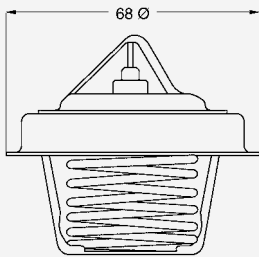

Typ 4449

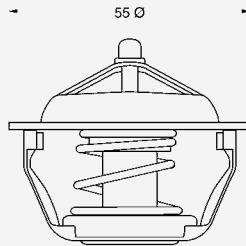

Typ 4450

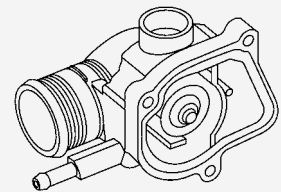

Typ 4453

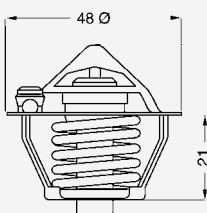

Typ 4457

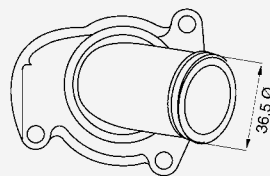

Typ 4459

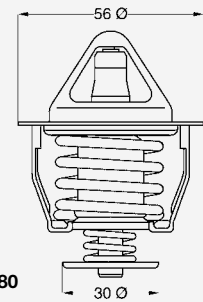

Typ 4480

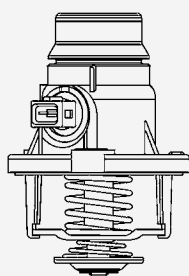

Typ 4508

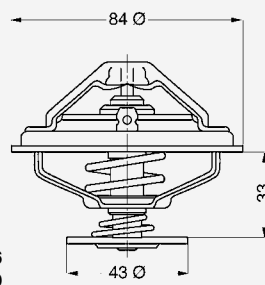

Typ 4516  
4519

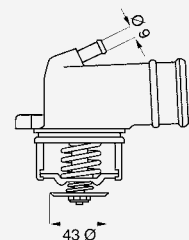

Typ 4517

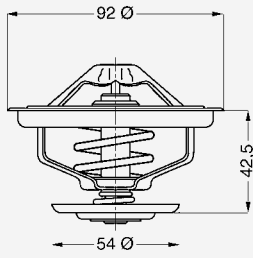
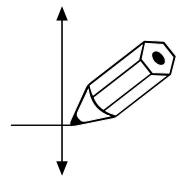

Typ 4520

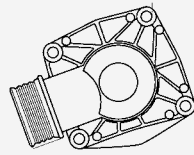

Typ 4594

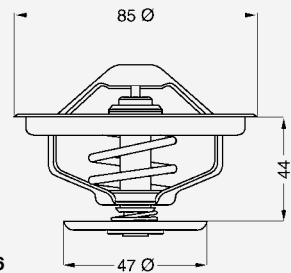

Typ 4596  
4530 mit Entlüftungs-  
kerbe

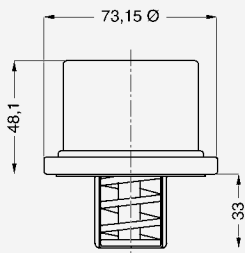

Typ 4619

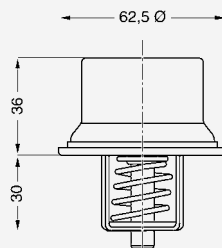

Typ 4621

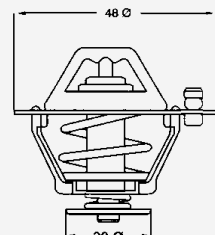

Typ 4634

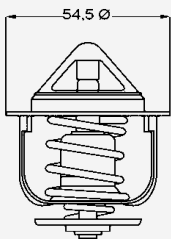

Typ 4635

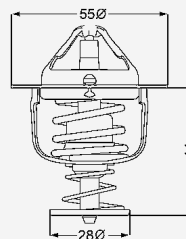

Typ 4637

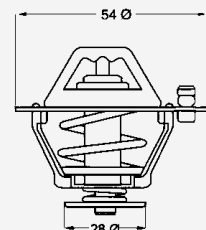

Typ 4638

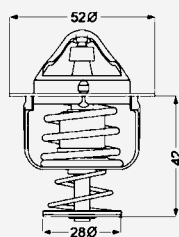

Typ 4639

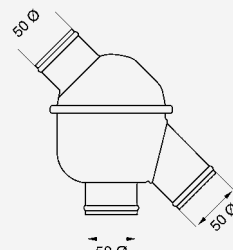

Typ 4663  
4684 mit Entlüftungs-  
kerbe mit Entlüftungs-  
ventil

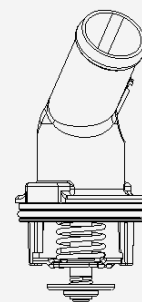

Typ 4814

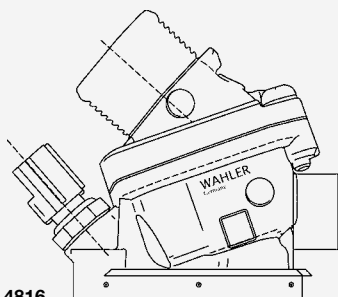

Typ 4816

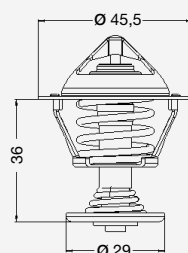

Typ 4821

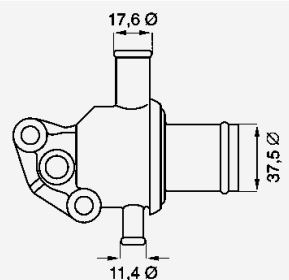

Typ 410007

# Assembly dimensions

2- polig

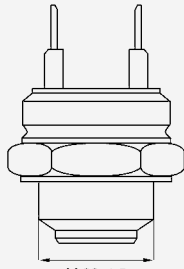

Typ 6010

M 22x1,5

2- polig

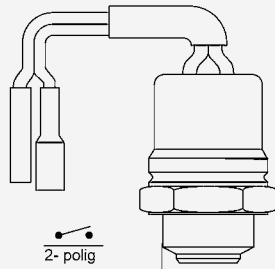

Typ 6016

M 22x1,5

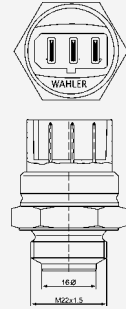

Typ 6017

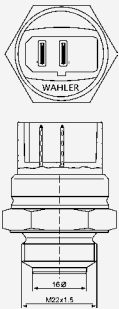

Typ 6020

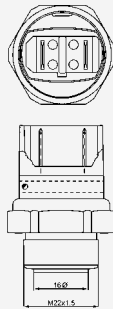

Typ 6024

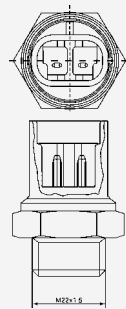

Typ 6031

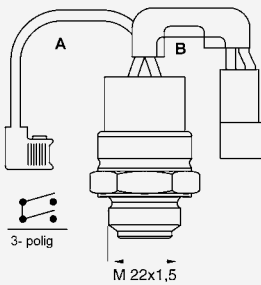

3- polig

M 22x1,5

3- polig

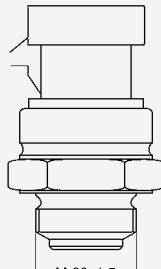

Typ 6035

M 22x1,5

3- polig

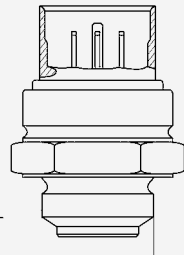

Typ 6037

M 22x1,5

Typ B A  
6033 580/1.000 mm  
6040 180/200 mm

2- polig

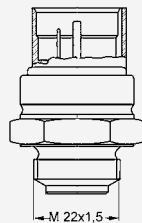

Typ 6039

M 22x1,5

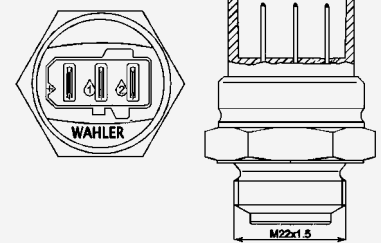

Typ 6087

M 22x1,5

# Explanations

2 / 3 connections
2 / 4 pole
2-piece aluminum housing
A = actuator
EGR valve
automatic transmission
Chassis number
D = throttle flap
thermostat housing cover
seal
seal
DPF = Diesel particle filter
throttle flap
attached to the cylinder head
insert Thermostat
electrical
electrical heated
electrically controlled
no longer available
Europe
Excl. = exclude
for original number
housing
threat
Japan
catalyst
catalyst type
electrically heated thermostat
air conditioner
plastic cover
L = EGR-pipe
pipe throttle valve to cylinder hea
metal cover
with
engine number
upper
without
oil cooling
organisation number
diesel sootfilter
pneumatic
Retarder
particle filter
manual transmission
black
series / Standard equipment
available while stocks last
thermal
lower
USA
V = EGR valve
variant
water cooling
additionally required parts
XXX → = from
→ XXX = up to
XXX → XXX = from → up to
▲ = new part number
● = article to be discontinued