



INSTALLATION INSTRUCTIONS



CG2 LED MINI CANNON Installation Instructions



About The CG2 LED Mini Cannon:

| | |
|---|----------------------|
| 1 | GEN 2 Mini Cannon |
|  | |
| LIGHT | Qty: 1 |

| | |
|---|---------|
| 2 | Pigtail |
|  | |
| PART (P1) | Qty: 1 |

| | |
|---|-----------------------|
| 3 | Hex Head Bolt [M8] |
|  | |
| PART (B1) | Qty: 1 |

| | |
|---|----------------|
| 4 | Washer [M8] |
|  | |
| PART (W1) | Qty: 1 |

| | |
|---|--------------------|
| 5 | Nylock Nut [M8] |
|  | |
| PART (N1) | Qty: 1 |

| | |
|---|--------------------|
| 6 | Allen Key [5mm] |
|  | |
| PART (A1) | Qty: 1 |

FEATURES

1. Lightweight hybrid housing.
2. 7W High Output Cree LEDs.
3. Integrated electronic thermal management (ETM).

3.7" CG2 LED MINI CANNON SPECIFICATION

- | | |
|------------------|----------------------------------|
| 1. Warranty | : Extended |
| 2. Amp Draw | : 1.75A @ 12V DC |
| 3. Input Voltage | : 9-32V DC |
| 4. Beam Patterns | : 10°, Snap-On Filters Available |
| 5. LED Lifespan | : 50,000 Hours |

PREPARATION

1. We recommend completely reading instructions before installing.
2. Consult your local state regulatory agency regarding the use of LED lighting.
3. The placement of LED lighting should not restrict airflow to the radiator, or block head lamps, turn signals, or parking lights.

3.7” CG2 LED MINI CANNON



WARNING: Bolts, Nuts, and Washers are Stainless Steel. DO NOT USE Pneumatic or Electric Tools to Tighten and Loosen. The Hardware Will Permanently Lock Together.

MOUNTING INSTALLATION INSTRUCTION

1. Determine where the light/lights will be placed.
2. Place mounting bracket with light to desired location. Using a marker or pick tool, mark the center point of the bolt hole on the mounting surface.
3. Set the light aside. Drill out a large enough hole to fit the [M8] bolt Part (B1).
4. Line up the mounting bracket with the hole you just drilled, slide the [M8] Bolt (B1) through both.
5. On the other side of mounting surface slide the [M8] Washer Part (W1) and [M8] Nylock Nut Part (N1) onto the [M8] Bolt (B1). Tighten Nut & Bolt to desired tightness.

MOUNTING DIAGRAM

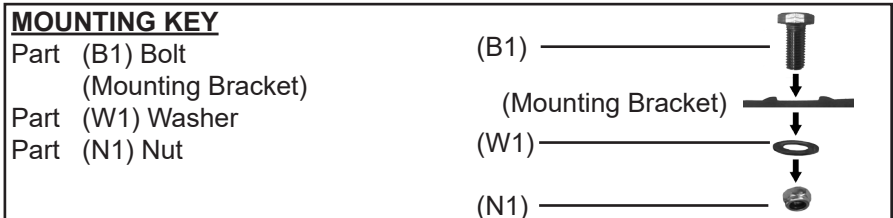

LIGHT ANGLE ADJUSTMENTS

1. Use the 5mm Allen Key PART (A1) to loosen the Allen head bolts Part (B2) on the side of the light.
2. Adjust the light to your desired angle and tighten Bolt (B2).

LIGHT ANGLE ADJUSTMENT DIAGRAM:

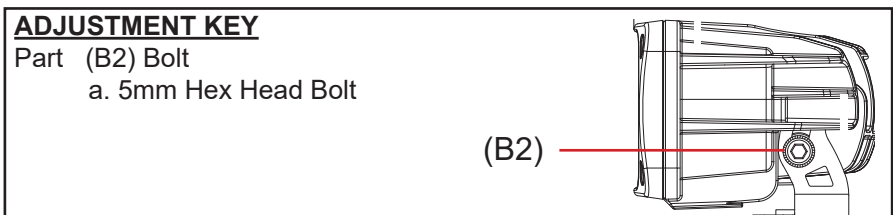

MAINTENANCE

All Vision X models have been designed for maintenance free use. In the case that an LED lamp or other part replacement is needed please contact your authorized service center.



WIRING INSTALLATION INSTRUCTION

1. Supplied with the CG2 Mini-Cannon is a 3" Pigtail, Part (P1).
2. Connect the positive red wire Part (R1), and negative black wire Part (B1), into an existing power source.

WIRING DIAGRAM

COMPONENTS KEY

- Part (P1) Pigtail
Part (R1) Power Wire
a. 12-32V DC Positive (+) Input Wire
Part (B1) Ground Wire
a. 12-32V Negative (-) Input Wire

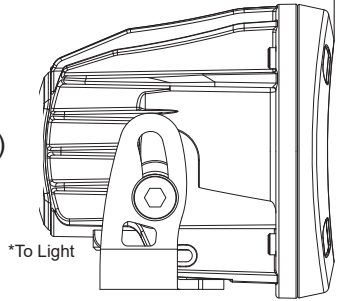
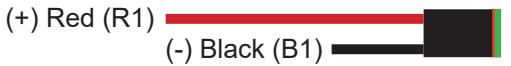

DIMMER WIRE:

Do Not connect
without authorized
accessories.

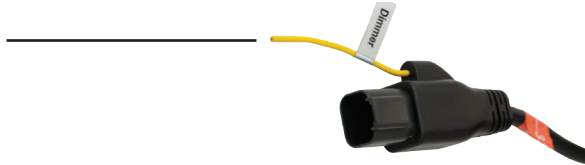

DIMMING FUNCTION

Your light is capable of dimming through the Prime Drive wire on the light's plug. To achieve this requires our authorized accessories, the XIL-PDIMMER, or XIL-PDIMMERBUTTON.

Do Not connect the Prime Drive wire without authorized accessories as this will damage the electronics.