

Vibrant Performance Stainless Steel Universal Performance Mufflers are made from T304 Stainless Steel. Our "True Straight Through" internals feature a Stainless Steel Perforated Tube that is wrapped in our premium quality, multi-layer sound suppression material that will produce a low, deep tone while allowing for unrestricted flow and maximum horsepower. These Mufflers are not flow directional, allowing the installer the flexibility needed for custom exhaust fabrication.



center - center



center - center



Part No.	Inlet / Outlet I.D.	Muffler Body Height x Width	Body Length	Overall Length
1101	2 1/4"	5" x 9"	15"	19"
1102	2 1/2"	5" x 9"	15"	19"
1132	2 3/4"	5" x 9"	15"	19"
1103	3"	5" x 9"	15"	19"
1135	3 1/2"	5" x 9"	15"	19"
1137	4"	5" x 9"	15"	19"

Part No.	Inlet / Outlet I.D.	Muffler Body O.D.	Body Length	Overall Length
1117	2 1/4"	6"	14"	18"
1118	2 1/2"	6"	14"	18"
1119	3"	6"	14"	18"
1124	3 1/2"	6"	14"	18"
1139	4"	7"	18"	22"



center - offset



center - dual



Part No.	Inlet / Outlet I.D.	Muffler Body Height x Width	Body Length	Overall Length
1105	2 1/4"	5" x 9"	15"	19"
1106	2 1/2"	5" x 9"	15"	19"
1107	3"	5" x 9"	15"	19"

Part No.	Inlet I.D.	Outlet O.D.	Muffler Body Height x Width	Body Length	Overall Length
1110	2 1/2"	Dual 2 1/4"	5" x 9"	15"	19"
1111	3"	Dual 2 1/2"	5" x 9"	15"	19"

Outlet Center to Center Dimension = 4"



offset - offset

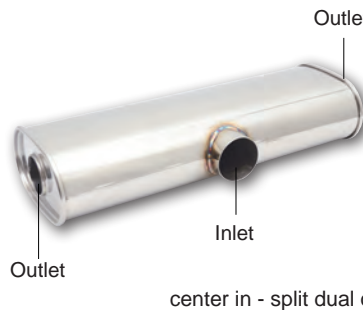
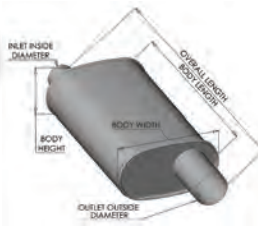

center in - split dual out



Part No.	Inlet / Outlet I.D.	Muffler Body Height x Width	Body Length	Overall Length
1126	2 1/2"	5" x 9"	15"	19"
1127	3"	5" x 9"	15"	19"

Part No.	Inlet I.D.	Outlet O.D.	Muffler Body Height x Width	Body Length	Overall Length
10632	3"	Dual 2 1/2"	6" x 10"	24"	24"
10633	2 1/2"	Dual 2 1/4"	6" x 10"	24"	24"
10635	3 1/2"	Dual 3"	6" x 10"	24"	24"

Vibrant Performance Flat Black Universal Mufflers feature 100% Stainless Steel construction and our "True Straight Through" internals for unrestricted exhaust gas flow. The perforated core is surrounded by our premium quality sound suppression material that helps produce a low, deep tone. These stealthy mufflers are very popular, especially for avoiding unwanted attention.

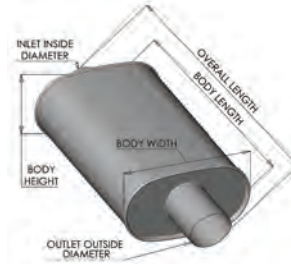

Part No.	Inlet I.D.	Outlet O.D.	Outlet Length	Muffler Body Height x Width	Body Length	Overall Length
1145	2 1/4"	3"	4 1/2"	5" x 9"	15"	21 1/2"
1146	2 1/2"	3"	4 1/2"	5" x 9"	15"	21 1/2"
1147	3"	3"	4 1/2"	5" x 9"	15"	21 1/2"
1153	3 1/2"	3 1/2"	4 1/2"	5" x 9"	15"	21 1/2"
1154	4"	4"	4 1/2"	5" x 9"	15"	21 1/2"

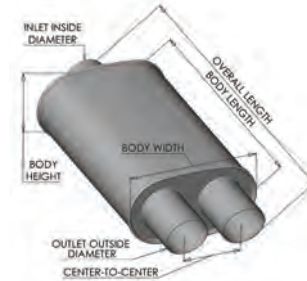

Part No.	Inlet I.D.	Outlet O.D.	Outlet Length	Center to Center	Muffler Body Height x Width	Body Length	Overall Length
1148	2 1/2"	Dual 3"	4 1/2"	4"	5" x 9"	15"	21 1/2"
1149	3"	Dual 3"	4 1/2"	4"	5" x 9"	15"	21 1/2"
1155	4"	Dual 3"	4 1/2"	4"	5" x 9"	15"	21 1/2"

TPV UNIVERSAL MUFFLERS

Vibrant Performance TPV Universal Mufflers are designed to withstand the extreme demands of high performance vehicles. They feature T304 Stainless Steel construction, are fully TIG welded for optimum durability and come with "True Straight Through" internals for unrestricted exhaust flow and maximum power gains. We densely pack all TPV mufflers with our premium multi-layer sound suppression materials to ensure a low, deep exhaust note. Suitable for both Naturally Aspirated and Forced Induction applications.



angle cut tip

Part No.	Inlet I.D.	Outlet O.D.	Muffler Body O.D.	Body Length	Overall Length
1056	2 1/2"	4"	6 1/4" O.D.	14"	21"
1061	3"	4"	6 1/4" O.D.	10"	17"
1058	3"	4"	6 1/4" O.D.	14"	21"
1090	4"	4"	6 1/4" O.D.	14"	21"



straight cut tip

Part No.	Inlet I.D.	Outlet O.D.	Muffler Body O.D.	Body Length	Overall Length
1057	2 1/2"	4"	6 1/4" O.D.	14"	21"
1062	3"	4"	6 1/4" O.D.	10"	17"
1059	3"	4"	6 1/4" O.D.	14"	21"
1091	4"	4"	6 1/4" O.D.	14"	21"

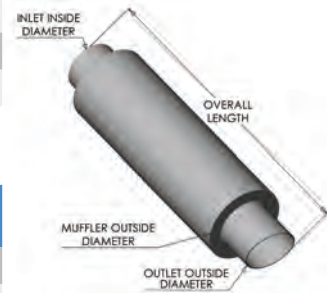

StreetPower Universal Performance Mufflers offer a perfect balance of subtle styling and all out power. These mufflers are constructed from T304 Stainless Steel for optimum durability and corrosion resistance. Each oval bodied muffler shell is densely packed with our premium multi-layer sound suppression material that produces a very distinctive deep exhaust note. Suitable for both Naturally Aspirated and Forced Induction applications.

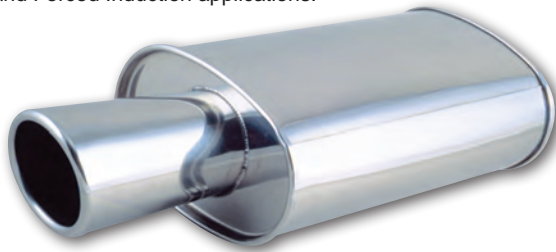

Exhaust Tip Detail: Single Wall, Angle Cut, Rolled Edge

Part No.	Inlet I.D.	Outlet O.D.	Muffler Body Height x Width	Body Length	Overall Length
1046	2 1/2"	4"	5" x 9"	15"	24"
1042	3"	4"	5" x 9"	15"	24"

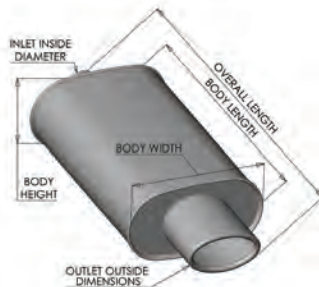

Exhaust Tip Detail: Single Wall, Angle Cut, Rolled Edge

Part No.	Inlet I.D.	Outlet Dim.	Muffler Body Height x Width	Body Length	Overall Length
1034	2 1/2"	4 1/2" x 3" Oval	5" x 9"	15"	24"
1045	3"	4 1/2" x 3" Oval	5" x 9"	15"	24"

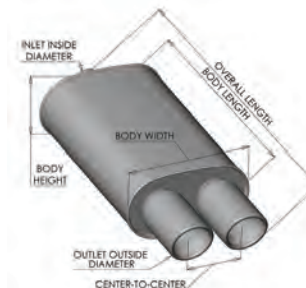

Exhaust Tip Detail: Double Wall, Angle Cut, Rolled Edge

Part No.	Inlet I.D.	Outlet O.D.	Center to Center	Muffler Body Height x Width	Body Length	Overall Length
1032	2 1/2"	Dual 3 1/2"	3 1/2"	5" x 9"	15"	24"
1043	3"	Dual 3 1/2"	3 1/2"	5" x 9"	15"	24"

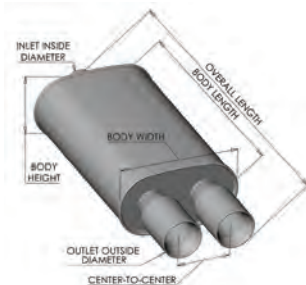

Exhaust Tip Detail: Double Wall, Straight Cut, Beveled Edge

Part No.	Inlet I.D.	Outlet O.D.	Center to Center	Muffler Body Height x Width	Body Length	Overall Length
1040	2 1/2"	Dual 3 1/2"	4 1/4"	5" x 9"	15"	24"
1047	3"	Dual 3 1/2"	4 1/4"	5" x 9"	15"	24"

STAINLESS STEEL RESONATORS

ULTRA QUIET DESIGN

Vibrant Performance Ultra Quiet Resonators are constructed from T304 Stainless Steel and features a "True Straight Through" perforated core that is surrounded by our premium multi-layer sound suppression materials. Ultra Quiet Resonators feature a larger sound chamber than our standard resonators to further reduce exhaust tone.



"True Straight Through"
Stainless Steel perforated core



Part No.	Inlet / Outlet I.D.	Muffler Body Width x Height	Body Length	Overall Length
1140	2 1/4"	6 3/4" x 4 1/2"	10"	14"
1141	2 1/2"	6 3/4" x 4 1/2"	10"	14"
1142	3"	6 3/4" x 4 1/2"	10"	14"

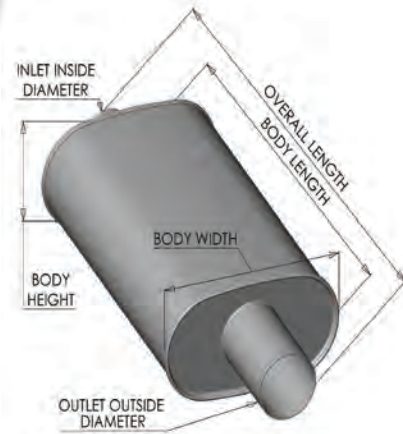

STANDARD DESIGN

Vibrant Performance Resonators are constructed from T304 Stainless Steel and feature a "True Straight Through" perforated core for unrestricted exhaust flow while still noticeably reducing exhaust dB levels.



Part No.	Inlet / Outlet I.D.	Resonator O.D.	Overall Length
1790	2 1/4"	3 1/2"	12"
1791	2 1/4"	3 1/2"	18"
1792	2 1/2"	4"	12"
1793	2 1/2"	4"	18"
17930	2 1/2"	5"	18"
1794	3"	4"	12"
1795	3"	4"	18"
17950	3"	5"	18"
17970	3 1/2"	5"	18"
17960	4"	5"	18"

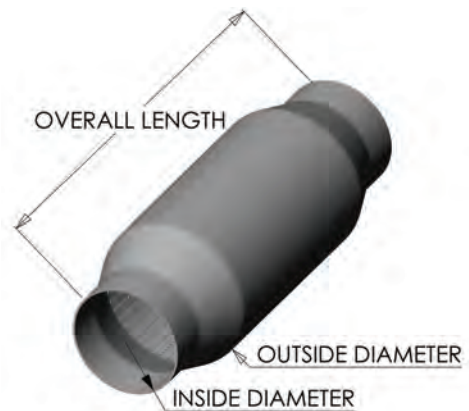

STAINLESS STEEL RACE MUFFLERS

Vibrant Performance Race Mufflers are designed to comply with muffler requirement rules at race tracks throughout North America. Constructed from T304 Stainless Steel and fully tig welded, these mufflers are very lightweight, compact and offer excellent durability and corrosion resistance. These Race Mufflers feature a "True Straight Through" perforated core that is designed to reduce noise levels without performance loss.

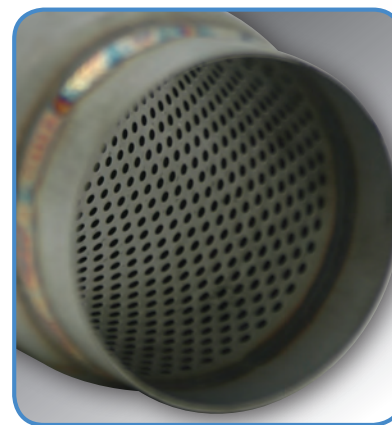

"True Straight Through"
Stainless Steel perforated core

9" LONG RACE MUFFLERS

Part No.	Inlet/Outlet	Dimensions	Unit Weight
1769	3"	3 3/4" O.D. x 9" Long	1.7 lbs
1796	3 1/2"	4 1/4" O.D. x 9" Long	1.9 lbs
1797	4"	4 3/4" O.D. x 9" Long	2.2 lbs
1799	5"	5 3/4" O.D. x 9" Long	2.7 lbs

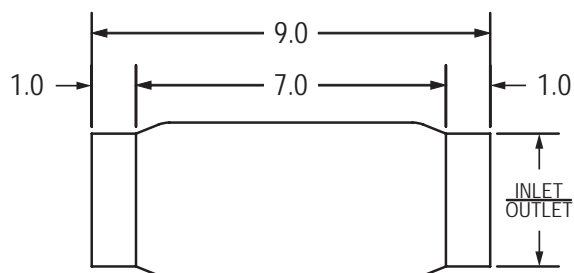

5" LONG RACE MUFFLERS

Part No.	Inlet/Outlet	Dimensions	Unit Weight
17695	3"	3 1/2" O.D. x 5" Long	1.1 lbs
17965	3 1/2"	4 1/4" O.D. x 5" Long	1.2 lbs
17975	4"	4 3/4" O.D. x 5" Long	1.4 lbs
17985	4 1/2"	5 1/8" O.D. x 5" Long	1.6 lbs
17995	5"	5 3/4" O.D. x 5" Long	1.7 lbs

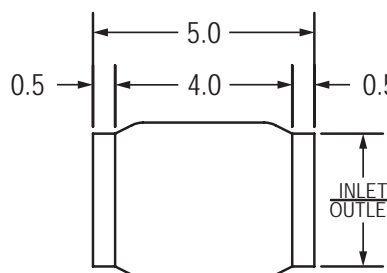

All dimensions in inches

LIGHTWEIGHT ALUMINUM MUFFLERS

Aluminum is quickly becoming the material of choice for Street Class racers and other performance enthusiasts who are looking to shave significant weight from their vehicle's exhaust system at a reasonable cost compared to other lightweight material options.

For those consumers, Vibrant offers our line of T6061 Aluminum Mufflers, with inlet/outlet sizes ranging from 2 1/2" to 4". These lightweight mufflers feature tig welded seams and our premium sound suppression packing materials wrapped around the large diameter "True Straight Through" internal perforated core.

Part No.	Inlet/Outlet	Dimensions	Unit Weight
12903	2 1/2"	5" O.D. x 14" Long	1.6 lbs
12900	3"	5" O.D. x 14" Long	1.7 lbs
12901	3 1/2"	5" O.D. x 14" Long	1.9 lbs
12902	4"	6" O.D. x 14" Long	2.4 lbs

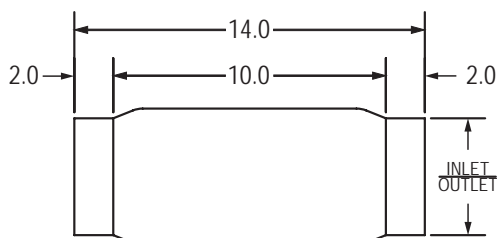

All dimensions in inches

