

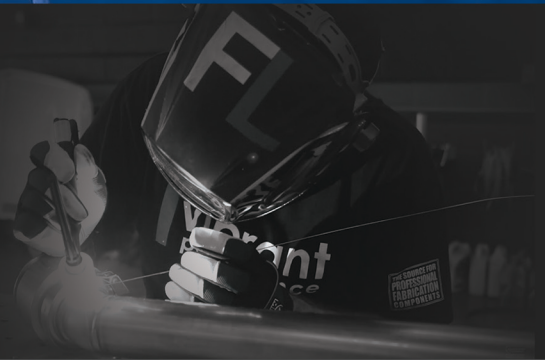

FABRICATION COMPONENTS GUIDE

REVISION 14

CELEBRATING 20 YEARS OF BUILDING DREAMS



Vibrant Performance Turns 20!

It has been a dream to be a part of the Performance Industry. Celebrating 20 years in this business is something we are humbled by, and incredibly thankful for.

The Vibrant Performance brand wasn't built overnight. Our pathway has been a winding road but our team had the foresight to identify where our market was headed, and we have worked hard, slowly carving out the niche in the industry that we serve every day.

Our success can be attributed to the leadership of Vibrant Power Inc.'s President, Dino Rossi. Since our brand's inception in 1998, we have been guided by his unending desire for fairness, the benefits of forging mutually beneficial partnerships and a mandate to have fun!

The team at Vibrant Performance is second to none. We are a passionate and considerate group that truly values the support of our customers and other partners, without whom we are nothing.

We feel so fortunate to work in an industry that exudes passion and creativity. Everyday, we get to play a small role in helping people's dream projects get built. It doesn't get much better than that!

From our team to yours, here's to continued growth and success.

TABLE OF CONTENTS

TITANIUM FABRICATION COMPONENTS

4-5

FLUID DELIVERY COMPONENTS

- Braided Flex Hose (Stainless Steel and Black Nylon) 7
- Hose End Fittings 8-9
- Push-On Flex Hose and Push-On Hose End Fittings 10
- Wire and Hose Protection 11
- Aluminum Adapter Fittings / Weld Bungs / Check Valves 12-21
- Baffled Catch Can Assemblies 22
- Vacuum Manifold / Push Lock Vacuum Fittings / Polyethylene Vacuum Lines 23
- Tools and Miscellaneous Components 24-25
- Oil Restrictor Fittings / Oil Feed & Drain Kits / Oil Feed & Drain Flanges 26-27

INDUCTION COMPONENTS

- Air to Air Intercoolers / Oil Coolers 29
- Aluminum Mandrel Bends / Straight Tubing / Transitions / Cast Elbows 30-32
- HD Clamp System 33
- Manual Boost Controller 34
- Boost Brace 34
- Aramid Reinforced Silicone Couplers / Heater Hose / Vacuum Hose 35-39
- Hose Clamps 40-41
- Performance Air Filters / Bellmouth Velocity Stacks 42-43

EXHAUST COMPONENTS

- Stainless Steel and Mild Steel Tubing (Mandrel Bends / Straight Tubing) 45-50
- Stainless Steel Schedule 10 Pipes 51
- Stainless Steel Exhaust Flanges (2-bolt / 3-bolt / 4-bolt) 52
- V-band Flange Assemblies (Stainless and Aluminum) 53
- Turbo Flanges and Fittings 54-60
- Exhaust Manifold Fittings 61
- Merge Collectors 62-63
- Stainless Steel Flexible Couplings 64-65
- GESi High Flow Universal Catalytic Converters 66
- Exhaust Bungs 67
- Exhaust Clamps, Hardware and Accessories 68-69
- Universal Mufflers and Resonators 70-73
- Stainless Steel Exhaust Tips 74-75
- Heat and Acoustic Shields 76

Titanium Fabrication Components

Titanium has long been used in the Aerospace and Motorsports industries due to its outstanding strength to weight ratio. Those characteristics make Titanium the ideal raw material for professional fabricators looking to build durable and ultra-lightweight high performance induction and exhaust components that can stand up to the rigors of racing. Best of all, Vibrant makes Titanium more affordable than it has been in the past.

STRONGER. LIGHTER. FASTER.

Titanium Mufflers and Resonators

- Manufactured entirely from CP1 Grade Titanium.
- "True Straight Through" perforated Titanium core ensures unrestricted exhaust flow.



Part No.	Inlet ID	Tip O.D. (Tip Finish)	Muffler Body O.D.	Overall Length	Unit Weight
17560	2.50" (63.5mm)	4.00" (101.6mm) Blue Ti Finish	6.30" (160mm)	17.00" (432mm)	4.10 lbs. (1.86 kg)
17561	2.50" (63.5mm)	4.00" (101.6mm) Natural Finish	6.30" (160mm)	17.00" (432mm)	4.10 lbs. (1.86 kg)
17562	3.00" (76.2mm)	4.00" (101.6mm) Blue Ti Finish	6.30" (160mm)	17.00" (432mm)	4.12 lbs. (1.87 kg)
17563	3.00" (76.2mm)	4.00" (101.6mm) Natural Finish	6.30" (160mm)	17.00" (432mm)	4.12 lbs. (1.87 kg)
17564	3.50" (88.9mm)	4.00" (101.6mm) Blue Ti Finish	6.30" (160mm)	17.00" (432mm)	4.23 lbs (1.92 kg)
17565	3.50" (88.9mm)	4.00" (101.6mm) Natural Finish	6.30" (160mm)	17.00" (432mm)	4.23 lbs (1.92 kg)

Part No.	Inlet / Outlet ID	Body O.D.	Overall Length	Unit Weight
17525	2.50" (63.5mm)	4.25" (108mm)	12.00" (305mm)	1.92 lbs (0.87 kg)
17527	2.50" (63.5mm)	5.50" (138mm)	16.00" (406mm)	3.83 lbs (1.74 kg)
17530	3.00" (76.2mm)	4.25" (108mm)	12.00" (305mm)	1.94 lbs (0.88 kg)
17532	3.00" (76.2mm)	5.50" (138mm)	16.00" (406mm)	3.85 lbs (1.75 kg)
17535	3.50" (88.9mm)	5.50" (138mm)	16.00" (406mm)	3.94 lbs (1.79 kg)
17540	4.00" (101.6mm)	5.90" (150mm)	16.00" (406mm)	4.00 lbs (1.82 kg)



Vibrant Performance Titanium Mufflers and Resonators come densely packed with our premium, high temp sound absorption packing materials.

304 Stainless Steel Muffler Body Clamp



Features a thick rubber liner to prevent scratching or damaging your Titanium muffler. Allows for welding of Stainless Steel Hanger Rods.

Part No.	Description
17116	Clamp for 4.25" OD (108mm) Resonators
17117	Clamp for 5.50" OD (138mm) Resonators
17119	Clamp for 6.30" OD (160mm) Mufflers

Titanium Hanger Rod

These ultra-lightweight hollow titanium hanger rods are easily formed by hand with a lever style bending tool. Sold in Pairs.



Part No.	Rod O.D.	Rod Length	Package Quantity
11890A	0.375" (9.5mm)	10.00" (250mm)	2
11891A	0.50" (12.7mm)	10.00" (250mm)	2

Titanium Straight Tubing

- CP1 grade Titanium.
- 1.0 mm (0.039") thick.
- Sold in 1 meter (39.4") lengths.

Part No.	Tube O.D.	Tube Length
13368	1.50" (38.1mm)	39.40" (1 meter)
13369	1.75" (44.5mm)	39.40" (1 meter)
13370	2.00" (50.8mm)	39.40" (1 meter)
13371	2.25" (57.2mm)	39.40" (1 meter)
13372	2.50" (63.5mm)	39.40" (1 meter)
13374	3.00" (76.2mm)	39.40" (1 meter)
13375	3.50" (88.9mm)	39.40" (1 meter)
13376	4.00" (101.6mm)	39.40" (1 meter)

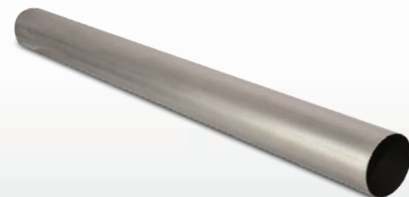

Titanium Mandrel Bends

These mandrel bends are manufactured from 1.2mm (0.047") thick CP1 Titanium tubing and are approximately half the weight of equivalent 16 gauge 304 SS bends, while still offering the same overall strength and performance.

Part No.	Bend Angle	Tube O.D.	CLR	Leg Length
13452	45°	2.50" (63.5mm)	3.95" (100mm)	5.00" (127mm)
13902	90°	2.50" (63.5mm)	3.95" (100mm)	5.00" (127mm)
13454	45°	3.00" (76.2mm)	4.75" (120mm)	5.00" (127mm)
13904	90°	3.00" (76.2mm)	4.75" (120mm)	5.00" (127mm)
13455	45°	3.50" (88.9mm)	5.60" (142.5mm)	5.00" (127mm)
13905	90°	3.50" (88.9mm)	5.60" (142.5mm)	5.00" (127mm)



Titanium Pie Cuts

- Precision Laser Cut.
- CP1 grade Titanium.
- 1.0mm (0.039") thick.
- 5 Pie Cuts at 9° each = 45° elbow.



Part No.	Tube O.D.	Package Quantity
13268	1.50" (38.1mm)	5 pcs / box
13269	1.75" (44.5mm)	5 pcs / box
13270	2.00" (50.8mm)	5 pcs / box
13271	2.25" (57.2mm)	5 pcs / box
13272	2.50" (63.5mm)	5 pcs / box
13274	3.00" (76.2mm)	5 pcs / box
13275	3.50" (88.9mm)	5 pcs / box
13276	4.00" (101.6mm)	5 pcs / box

Titanium V-Band Flange Assemblies

Vibrant Performance Titanium V-Band Flanges feature a unique "Male/Female" locking design to allow for a gasket free seal and to ensure proper alignment inside the clamp.

Full Assembly consists of a pair of Titanium Flanges and a 300 series Stainless Steel V-Band Clamp.



Full Assembly Part No.	Tube Size	Flange O.D.	Individual Male V-Band Flange Part No.	Individual Female V-Band Flange Part No.	Stainless Steel V-Band Clamp Part No.
12490	For 2.50" (63.5mm) O.D. tubing	2.56" (65mm)	12490M	12490F	1490C
12491	For 3.00" (76.2mm) O.D. tubing	3.19" (81mm)	12491M	12491F	1491C
12492	For 3.50" (88.9mm) O.D. tubing	3.78" (96mm)	12492M	12492F	1492C
12493	For 4.00" (101.6mm) O.D. tubing	4.13" (104.9mm)	12493M	12493F	1493C

Titanium Weld Bungs



Part No.	Description
1194T	Titanium O2 Bung (tapped M18 x 1.5)
1197T	Titanium EGT Bung (tapped 1/8"-27 NPT)

Titanium Filler Rod

- Sold in convenient 1 lb. quantity.



Part No.	Filler Rod Thickness	Filler Rod Length
29911	0.039" (1.00mm)	39.00" (1 meter)
29961	0.063" (1.60mm)	39.00" (1 meter)

Titanium Weld Tab Set

- Titanium Weld Tabs.
- Stainless Steel Spring.

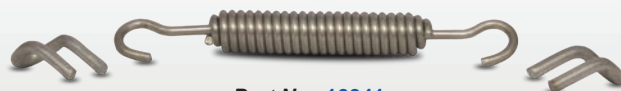

Part No. 10341



fluid delivery

Over the past five years, Vibrant Performance has developed one of the most comprehensive offerings of high performance Fluid Delivery Components.

Our ever-expanding program, consisting of flexible race hoses, hose ends and adapter fittings, as well as a variety of tools and accessories. These race proven products deliver outstanding quality at a fantastic value. Vibrant Performance is the source for affordable and accessible professional plumbing solutions.

Stainless Steel Braided Flex Hose

- Stainless steel braided cover (to resist against abrasion and corrosion) surrounds a reinforced synthetic rubber inner liner.
- Suitable for oil, water, fuel, methanol, coolant and vacuum service. E85 Friendly.
- NOT suitable for use as brake lines or other hydraulic pressure lines.
- Operating temperature range: -40°F (-40°C) to 300°F (150°C).



Size	I.D.	O.D.	Operating Pressure	Burst Pressure	2ft Roll Part No.	5ft Roll Part No.	10ft Roll Part No.	20ft Roll Part No.	50ft Roll Part No.
4AN	0.22" (5.6mm)	0.44" (11.2mm)	1000psi	6000psi	11904	11934	11914	11924	--
6AN	0.34" (8.6mm)	0.55" (14mm)	1000psi	6000psi	11906	11936	11916	11926	11946
8AN	0.44" (11.2mm)	0.63" (15.9mm)	1000psi	5000psi	11908	11938	11918	11928	11948
10AN	0.56" (14.2mm)	0.83" (21.1mm)	1000psi	5000psi	11910	11940	11920	11930	11949
12AN	0.68" (17.3mm)	0.95" (24.1mm)	1000psi	3750psi	11912	11942	11922	11932	--
16AN	0.89" (22.6mm)	1.20" (30.5mm)	750psi	2500psi	11913	11943	11923	11933	--
20AN	1.125" (28.6mm)	1.40" (35.6mm)	500psi	2000psi	11915	11945	11925	11935	--

Nylon Braided Lightweight Flex Hose



All Black



Black/Blue



Black/Red

- The black nylon braided outer cover provides excellent abrasion resistance. A flexible stainless steel inner core reinforces the synthetic rubber inner liner for improved strength.
- Up to 40% lighter than Stainless Steel Braided Flex Hoses.
- Suitable for oil, water, fuel, methanol, coolant and vacuum service. E85 Friendly.
- Operating temp. range: -40°F (-40°C) to 300°F (150°C).



Size	I.D.	O.D.	Operating Pressure	Burst Pressure	2ft Roll Part No.	5ft Roll Part No.	10ft Roll Part No.	20ft Roll Part No.	50ft Roll Part No.
4AN	0.22" (5.6mm)	0.44" (11.2mm)	500psi	2000psi	11954	11984	11964	11974	--
6AN	0.34" (8.6mm)	0.55" (14mm)	500psi	2000psi	11956	11986	11966	11976	*11996
8AN	0.44" (11.2mm)	0.63" (15.9mm)	500psi	2000psi	11958	11988	11968	11978	*11998
10AN	0.56" (14.2mm)	0.83" (21.1mm)	500psi	2000psi	11960	11990	11970	11980	*12000
12AN	0.68" (17.3mm)	0.95" (24.1mm)	350psi	1400psi	11962	11992	11972	11982	*12002
16AN	0.89" (22.6mm)	1.20" (30.5mm)	350psi	1400psi	*11963	*11993	*11973	*11983	*12003
20AN	1.125" (28.6mm)	1.40" (35.6mm)	350psi	1400psi	*11965	*11995	*11975	*11985	--

Please Note:

- Any part number denoted with an asterisk (*) is available only in All Black braid.
- All other items are available in All Black braid, Black/Blue braid and Black/Red braid.
- Add "B" after part number for Black/Blue braid (e.g. 11954B). Add "R" after part number for Black/Red braid (e.g. 11954R).

Flex Hose Inner Support Springs (sold in 4 foot Lengths)

A support spring provides your braided flex hoses with critical support to avoid collapse under extreme vacuum or if attempting very tight bends.



Part No. Hose Size

17306	6AN
17308	8AN
17310	10AN
17312	12AN
17316	16AN
17320	20AN

Aluminum Swivel Hose End Fittings, Female AN

Vibrant swivel-style Hose End Fittings deliver the type of quality, reliability, smooth flow and ease of assembly that industry professionals demand. Made from 6061 Aluminum Alloy, these lightweight fittings are suitable for use in oil, fuel, coolant and vacuum applications and feature double PTFE O-Ring seals for leak-free service when installed properly. Best of all, they look great too. Our signature Double Anodized and polished finish delivers remarkable color consistency from one batch to the next. Available in anodized black finish only.

Suitable for use with all Vibrant Braided Flex Hoses (please refer to Page 7).

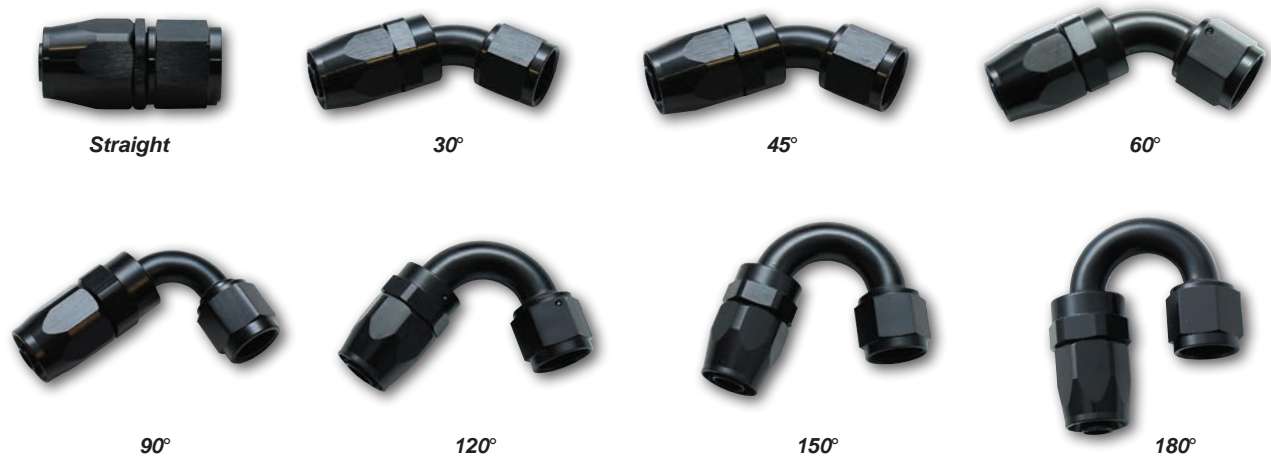

AN Hose Size

Hose End Style	4AN	6AN	8AN	10AN	12AN	16AN	20AN
Straight	21004	21006	21008	21010	21012	21016	21020
30°	21304	21306	21308	21310	21312	21316	21320
45°	21404	21406	21408	21410	21412	21416	21420
60°	21604	21606	21608	21610	21612	21616	21620
90°	21904	21906	21908	21910	21912	21916	21920
120°	21204	21206	21208	21210	21212	21216	21220
150°	21504	21506	21508	21510	21512	21516	21520
180°	21804	21806	21808	21810	21812	21816	21820

90° Tight Radius Forged Hose End Fittings, Female AN

Part No.	AN Size
21986	6AN
21988	8AN
21990	10AN
21992	12AN
21996	16AN



Straight Swivel Hose End Fittings, Male AN Flare

Part No.	AN Size
24006	6AN
24008	8AN
24010	10AN
24012	12AN
24016	16AN



TECH TIP

Vibrant Performance Heat Protect Flexible Sleeving protects your Braided Flexible Race Hoses from ambient temperatures up to 500°F (260°C).

These sleeves are easy to install, will not melt, delaminate or become brittle under normal operating conditions and provides a professional solution to your thermal protection needs.

See Page 11 to view our complete assortment of Wire and Hose Protection Products.

45° and 90° Swivel Hose End Fittings, Male ORB



Please Note: Includes O-Ring

AN Hose Size	Male ORB Thread Size	45° Part No.	90° Part No.
6AN	4 ORB (7/16"-20)	24400	24900
6AN	6 ORB (9/16"-18)	24402	24902
6AN	8 ORB (3/4"-16)	24403	24903
8AN	6 ORB (9/16"-18)	24404	24904
8AN	8 ORB (3/4"-16)	24405	24905
8AN	10 ORB (7/8"-14)	24406	24906
10AN	8 ORB (3/4"-16)	24407	24907
10AN	10 ORB (7/8"-14)	24408	24908
10AN	12 ORB (1 1/16"-12)	24409	24909
12AN	10 ORB (7/8"-14)	24410	24910
12AN	12 ORB (1 1/16"-12)	24411	24911
16AN	12 ORB (1 1/16"-12)	24412	24912
16AN	16 ORB (1 5/16"-12)	24414	24914

Straight Swivel Hose End Fittings, Male NPT



Part No.	AN Hose Size	Male NPT Size
26000	6AN	1/8" NPT
26001	6AN	1/4" NPT
26002	6AN	3/8" NPT
26003	8AN	1/4" NPT
26004	8AN	3/8" NPT
26005	8AN	1/2" NPT
26006	10AN	3/8" NPT
26007	10AN	1/2" NPT
26008	12AN	1/2" NPT
26009	12AN	3/4" NPT
26010	16AN	3/4" NPT

45° and 90° Swivel Hose End Fittings, Male NPT



AN Hose Size	Male NPT Size	45° Part No.	90° Part No.
6AN	1/8"	26400	26900
6AN	1/4"	26401	26901
6AN	3/8"	26402	26902
8AN	1/4"	26403	26903
8AN	3/8"	26404	26904
8AN	1/2"	26405	26905
10AN	3/8"	26406	26906
10AN	1/2"	26407	26907
12AN	1/2"	26408	26908
12AN	3/4"	26409	26909
16AN	3/4"	26410	26910



TECH TIP

Vibrant Performance Hose End and Adapter Fittings are suitable for E85 service, as are all Vibrant Performance Braided Flex Hoses.

Replacement Hose End Sockets



AN Size	Black Part No.	Blue Part No.	Red Part No.	Chrome Part No.
4AN	20954	20954B	20954R	20954S
6AN	20956	20956B	20956R	20956S
8AN	20958	20958B	20958R	20958S
10AN	20960	20960B	20960R	20960S
12AN	20962	20962B	20962R	20962S
16AN	20966	20966B	20966R	20966S
20AN	20970	20970B	20970R	20970S

Push-On Style Rubber Flex Hose

- Designed for use with Vibrant Push-On Style Hose Ends and Fittings.
- Suitable for oil, water, fuel, methanol, coolant and vacuum service. E85 Friendly.
- Operating temperature range: -40°F (-40°C) to 212°F (100°C).
- Available only in black.



Please note:

Hose Clamps are required to secure push-on style hose to fittings if operating temperature exceeds 150°F (65°C) or if used on oil or fuel systems.

AN Hose Size	Hose I.D.	Hose O.D.	10ft Roll Part No.	20ft Roll Part No.	50ft Roll Part No.	Operating Pressure
4AN	0.25" (6.4mm)	0.47" (11.9mm)	16314	16324	16354	250psi
6 AN	0.375" (9.5mm)	0.625" (15.9mm)	16316	16326	16356	250psi
8 AN	0.50" (12.7mm)	0.75" (19.1mm)	16318	16328	16358	250psi
10 AN	0.625" (15.9mm)	0.90" (22.9mm)	16320	16330	16360	250psi
12 AN	0.75" (19.1mm)	1.03" (26.2mm)	16322	16332	16362	250psi

Push-On Style Hose End Fittings, Female AN

Vibrant Push-On Style Hose End Fittings are manufactured from 6061 aluminum alloy. These lightweight fittings allow for easy and secure hose assembly. Available in anodized black finish only. Suitable for use with all Vibrant Push-On Style Flex Hose.



Straight



30°



45°



60°



90°



120°



150°



180°

AN Hose Size

Hose End Style	4AN	6AN	8AN	10AN	12AN
Straight	22004	22006	22008	22010	22012
30°	22304	22306	22308	22310	22312
45°	22404	22406	22408	22410	22412
60°	22604	22606	22608	22610	22612
90°	22904	22906	22908	22910	22912
120°	22204	22206	22208	22210	22212
150°	22504	22506	22508	22510	22512
180°	22804	22806	22808	22810	22812



TECH TIP

Vibrant Performance Stainless Steel Pinch Clamps are ideal for securing Push-On style Flex Hose to fittings, especially if your application sees operating temperatures that exceed 150°F (66°C) or if used on oil and/or fuel systems. Refer to Page 40 for our complete offering of small diameter hose clamps.

Wire and Hose Protection

Flexible Split Sleeving



Available in black only

Nominal Size	Sleeve Length	Part No.
0.25" (6.4mm)	10.00' (3.048m)	25800
0.50" (12.7mm)	10.00' (3.048m)	25801
0.75" (19.1mm)	10.00' (3.048m)	25802
1.00" (25.4mm)	5.00' (1.524m)	25804
1.50" (38.1mm)	5.00' (1.524m)	25806

Lightweight and easy to install due to the unique self-wrapping split braid that allows for the addition or removal of wires, hoses or cables without disassembly. No need for fasteners like cable ties or tape, as these sleeves feature a 25% edge overlap and allow for tight radius bending without distorting. Use a Hot Knife to cut this sleeving to prevent fraying.

Heat Protect Flexible Sleeving



Available in black only
Sold in 2ft. and 5ft. lengths

Nominal Size	2' Length		5' Length	Use with AN Hose
	Part No.	Part No.	Part No.	
0.50" (12.7mm)	25840	25810	4AN	
0.625" (15.9mm)	25845	25815	6AN	
0.75" (19.1mm)	25841	25811	8AN	
0.875" (22.2mm)	25842	25812	10AN	
1.00" (25.4mm)	25843	25813	12AN	
1.25" (31.8mm)	25846	25816	16AN	
1.50" (38.1mm)	25847	25817	20AN	

These silicone wrapped fiberglass sleeves provide protection from ambient temperatures up to 500°F (260°C).

This sleeving is highly flexible and engineered to protect hoses, cables and wire harnesses from damage caused by exposure to extreme heat, open flame and weld sparks, as well as containing radiant heat. Resists automotive chemicals and solvents, and provides protection from abrasion, punctures and moisture.

EXTREMESHIELD 1200 Flexible Tubing



Available in Silver Only

Nominal Size	Sleeve Length	Part No.
0.50" (12.7mm)	5.00' (1.524m)	25820
0.75" (19.1mm)	5.00' (1.524m)	25821
1.00" (25.4mm)	5.00' (1.524m)	25822
1.25" (31.8mm)	5.00' (1.524m)	25823
1.50" (38.1mm)	5.00' (1.524m)	25824

EXTREMESHIELD 1200 Flexible Tubing provides easy slip-on installation and offers outstanding protection for your wires, hoses and cables from temperatures up to 1200°F (650°C).

Features an aluminized heat shield that is laminated onto tightly braided fiberglass insulation which provides superior protection from radiant heat. This tubing is not expandable so be sure to measure your application carefully.

EXTREMESHIELD 1400 Flexible Reflective Wrap

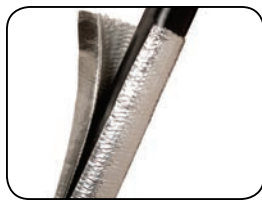

Available in Silver Only

Nominal Size	Sleeve Length	Part No.
0.50" (12.7mm)	4.00' (101.6mm)	25830
0.75" (19.05mm)	4.00' (101.6mm)	25831
1.00" (25.4mm)	4.00' (101.6mm)	25832
1.25" (31.75mm)	4.00' (101.6mm)	25833
1.50" (38.1mm)	4.00' (101.6mm)	25834

EXTREMESHIELD 1400 Thermal Wrap allows for easy installation on lines and hoses that are difficult to disassemble. Features an aluminized outer layer that is then bonded to insulating, self-wrapping fiberglass. Simply wrap the split tubing around your components and seal it with the included "peel and stick" high temperature self-adhesive strip. Designed to withstand and reflect temperatures up to 1400°F (760°C). Can be cut to size with a simple pair of scissors.

Spark Plug Boot Insulator

Protect your spark plug wires at the connection to the boot with these easy, slip on braided Fiberglass Insulation Sleeves. Protects up to 1200° F (650°C) and requires minimal clearance from the heat source.



Part No.	Nominal Size	Quantity	Color
25890	0.75" (19.1mm)	4 / pack	Natural
25891	0.75" (19.1mm)	4 / pack	Black

Stainless Steel Cable Ties

Ideal for installing/securing heavy duty and high temperature sleeving.



Part No.	Size	Quantity
25895	7.5" long	10 / pack
25898	14.5" long	10 / pack

Male AN Flare Union Adapters



Straight

45°

90°

AN Size	Straight Adapter Part No.	45° Adapter Part No.	90° Adapter Part No.
3AN	10230	10570	10550
4AN	10231	10571	10551
6AN	10232	10572	10552
8AN	10233	10573	10553
10AN	10234	10574	10554
12AN	10235	10575	10555
16AN	10236	10576	10556
20AN	10237	--	--

Female AN Flare Union Adapters



Straight

45°

90°

AN Size	Straight Adapter Part No.	45° Adapter Part No.	90° Adapter Part No.
3AN	10700	N/A	N/A
4AN	10701	10711	10731
6AN	10702	10712	10732
8AN	10703	10713	10733
10AN	10704	10714	10734
12AN	10705	10715	10735
16AN	10706	10716	10736
6AN x 8AN	10708	--	--
8AN x 10AN	10709	--	--

Male AN Flare Union Reducer Adapters



Part No.	Size 1	Size 2
10430	4AN	3AN
10431	6AN	4AN
10428	8AN	4AN
10432	8AN	6AN
10433	10AN	6AN
10434	10AN	8AN
10438	12AN	6AN
10435	12AN	8AN
10436	12AN	10AN
10439	16AN	10AN
10437	16AN	12AN
10427	20AN	12AN
10429	20AN	16AN

Female AN to Male AN Flare Reducer Adapters



Part No.	Female Size	Male Size
10830	4AN	3AN
10832	6AN	4AN
10833	8AN	6AN
10834	10AN	6AN
10835	10AN	8AN
10836	12AN	8AN
10837	12AN	10AN
10838	16AN	12AN
10839	20AN	16AN

Female AN to Male AN Flare Expander Adapters



Part No.	Female Size	Male Size
10840	3AN	4AN
10841	4AN	6AN
10842	6AN	8AN
10843	8AN	10AN
10844	10AN	12AN
10845	12AN	16AN
10846	16AN	20AN

Female AN to Male AN Flare Extension Adapters



Part No.	AN Size	Adapter Length
10585	4AN	1.00" (25.4mm)
10586	6AN	1.00" (25.4mm)
10587	8AN	1.50" (38.1mm)
10588	10AN	1.50" (38.1mm)
10589	12AN	1.50" (38.1mm)
10590	16AN	1.50" (38.1mm)

TECH TIP

To preserve the pristine finish of your Vibrant Performance Fittings, be sure to use our Billet Aluminum Wrenches and Vice Jaws when assembling your hoses and fittings. Refer to pg. 25 to view our offering of convenient tools for fitting/hose installation.

Female AN to Male AN Flare 45° and 90° Adapters



45°

90°

Female Size	Male Size	45° Adapter Part No.	90° Adapter Part No.
3AN	3AN	10770	10780
4AN	4AN	10771	10781
6AN	6AN	10772	10782
8AN	8AN	10773	10783
10AN	10AN	10774	10784
12AN	12AN	10775	10785
16AN	16AN	10776	10786

Male AN Flare Bulkhead Adapters



Straight



45°



90°



Bulkhead Tee



Bulkhead Tee on Run



Nut

<i>AN Size</i>	<i>Straight Bulkhead Part No.</i>	<i>45° Bulkhead Part No.</i>	<i>90° Bulkhead Part No.</i>	<i>Bulkhead Tee Part No.</i>	<i>Bulkhead Tee on Run Part No.</i>	<i>Bulkhead Nut Part No.</i>
3AN	10680	10600	10608	10616	10624	10690
4AN	10681	10601	10609	10617	10625	10691
6AN	10682	10602	10610	10618	10626	10692
8AN	10683	10603	10611	10619	10627	10693
10AN	10684	10604	10612	10620	10628	10694
12AN	10685	10605	10613	10621	10629	10695
16AN	10686	10606	10614	10622	10630	10696

Flare AN Tee Adapters

<i>AN Size</i>	<i>Male Flare Tee Part No.</i>	<i>Female Flare Tee Part No.</i>	<i>Male Flare Tee with Female on Run Part No.</i>	<i>Male Flare Tee with Female on Side Part No.</i>
3AN	10480	N/A	10740	10790
4AN	10481	10871	10741	10791
6AN	10482	10872	10742	10792
8AN	10483	10873	10743	10793
10AN	10484	10874	10744	10794
12AN	10485	--	10745	10795
16AN	10486	--	10746	10796



Male Flare Tee



Female Flare Tee



Male Flare Tee with Female on Run



Male Flare Tee with Female on Side

Male AN Flare to Pipe Tee Adapters



Male Flare Tee with Pipe Thread on Side



Male Flare Tee with Pipe Thread on Run

<i>AN Size</i>	<i>NPT Size</i>	<i>Male Flare Tee with Pipe on Side Part No.</i>	<i>Male Flare Tee with Pipe on Run Part No.</i>
3AN	1/8"	10460	10470
4AN	1/8"	10461	10471
6AN	1/4"	10462	10472
8AN	3/8"	10463	10473
10AN	1/2"	10464	10474
12AN	3/4"	10465	10475
16AN	1"	10466	10476

Male AN Flare to Metric Adapters
(includes Crush Washer)



Part No.	AN Size	Metric Size
16602	4AN	M8x1.0
16603	4AN	M8x1.25
16604	4AN	M10x1.0
16605	4AN	M10x1.25
16606	4AN	M10x1.5
16607	4AN	M12x1.0
16608	4AN	M12x1.25
16609	4AN	M12x1.5
16611	4AN	M14x1.5
16612	6AN	M10x1.0
16613	6AN	M10x1.25
16614	6AN	M10x1.5
16615	6AN	M12x1.25
16616	6AN	M12x1.5
10229	6AN	M14x1.5
16619	6AN	M16x1.5
10298	6AN	M18x1.5
16620	6AN	M20x1.5
16621	6AN	M22x1.5
16630	8AN	M10x1.0
16622	8AN	M10x1.5

Male AN Flare to Male ORB Adapters
(includes O-Ring)



Part No.	Male Flare AN Size	Male ORB Thread Size
16821	4AN	4 ORB (7/16" – 20)
16822	4AN	6 ORB (9/16" – 18)
16823	4AN	8 ORB (3/4" – 16)
16825	6AN	4 ORB (7/16" – 20)
16826	6AN	6 ORB (9/16" – 18)
16827	6AN	8 ORB (3/4" – 16)
16828	6AN	10 ORB (7/8" – 14)
16830	8AN	6 ORB (9/16" – 18)
16831	8AN	8 ORB (3/4" – 16)
16832	8AN	10 ORB (7/8" – 14)
16833	8AN	12 ORB (1 1/16" – 12)
16834	10AN	6 ORB (9/16" – 18)
16835	10AN	8 ORB (3/4" – 16)
16836	10AN	10 ORB (7/8" – 14)
16837	10AN	12 ORB (1 1/16" – 12)
16838	10AN	16 ORB (1 5/16" – 12)
16839	12AN	8 ORB (3/4" – 16)
16840	12AN	10 ORB (7/8" – 14)
16841	12AN	12 ORB (1 1/16" – 12)
16842	12AN	16 ORB (1 5/16" – 12)
16844	16AN	12 ORB (1 1/16" – 12)
16845	16AN	16 ORB (1 5/16" – 12)
16847	20AN	16 ORB (1 5/16" – 12)
16848	20AN	20 ORB (1 5/8" – 20)

Single Banjo Adapter Assembly, Male AN
(includes pair of crush washers)



Part No.	Banjo Size	Bolt Size
11500	3AN	M8x1.0
11501	3AN	M8x1.25
11502	3AN	M10x1.0
11503	3AN	M10x1.5
11504	3AN	M12x1.0
11505	3AN	M12x1.5
11510	4AN	M8x1.0
11511	4AN	M8x1.25
11512	4AN	M10x1.0
11513	4AN	M10x1.5
11514	4AN	M12x1.0
11515	4AN	M12x1.5

Part No.	Banjo Size	Bolt Size
11520	6AN	M10x1.0
11521	6AN	M10x1.5
11522	6AN	M12x1.0
11523	6AN	M12x1.5
11524	6AN	M14x1.5
11525	6AN	M16x1.5
11530	8AN	M10x1.0
11531	8AN	M10x1.5
11532	8AN	M12x1.0
11533	8AN	M12x1.5
11534	8AN	M14x1.5
11535	8AN	M16x1.5

Female AN Flare to Male ORB Adapters
(includes O-Ring)



Part No.	Female AN Size	Male ORB Thread Size
16860	6AN	6 ORB (9/16" – 18)
16862	6AN	8 ORB (3/4" – 16)
16861	8AN	6 ORB (9/16" – 18)
16863	8AN	8 ORB (3/4" – 16)
16866	8AN	10 ORB (7/8" – 14)
16864	10AN	8 ORB (3/4" – 16)
16867	10AN	10 ORB (7/8" – 14)
16870	10AN	12 ORB (1 1/16" – 12)
16868	12AN	10 ORB (7/8" – 14)
16871	12AN	12 ORB (1 1/16" – 12)

Male AN Flare to Male NPT Adapters

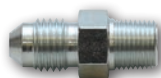

**Steel
Straight Adapter**



**Aluminum
Straight Adapter**



45° Adapter



90° Adapter

AN Size	NPT Size	Material	Straight Adapter Part No.	45° Adapter Part No.	90° Adapter Part No.
3AN	1/8"	Steel	10290	--	--
4AN	1/8"	Steel	10292	--	--
3AN	1/8"	Aluminum	10291	10240	10250A
3AN	1/4"	Aluminum	10176	--	--
4AN	1/8"	Aluminum	10293	10241	10251A
4AN	1/4"	Aluminum	10216	10238	10256
4AN	3/8"	Aluminum	10213	--	10286
6AN	1/8"	Aluminum	10217	10239	10257
6AN	1/4"	Aluminum	10220	10242	10252A
6AN	3/8"	Aluminum	10222	10245	10258
6AN	1/2"	Aluminum	10218	--	10249
8AN	1/4"	Aluminum	10219	--	10267
8AN	3/8"	Aluminum	10221	10243	10253
8AN	1/2"	Aluminum	10225	10247	10268
8AN	3/4"	Aluminum	10177	--	--
10AN	3/8"	Aluminum	10223	10248	10259
10AN	1/2"	Aluminum	10294	10297	10254
10AN	3/4"	Aluminum	10226	--	10299
12AN	1/2"	Aluminum	10227	--	10269
12AN	3/4"	Aluminum	10224	10244	10255
12AN	1"	Aluminum	10178	--	--
16AN	3/4"	Aluminum	10206	--	10285
16AN	1"	Aluminum	10228	10246	10284
20AN	1"	Aluminum	10179	--	--
20AN	1-1/4"	Aluminum	10207	--	--

Female AN Flare to Male NPT Adapters



Straight



90° Swivel

Female AN Size	Male NPT Size	Straight Part No.	Swivel Part No.	90° Swivel Part No.
3AN	1/8"	11365	11380	11380
4AN	1/8"	11366	11381	11381
4AN	1/4"	11367	11382	11382
6AN	1/8"	11368	11383	11383
6AN	1/4"	11369	11384	11384
6AN	3/8"	11370	11385	11385
8AN	1/4"	11371	11386	11386
8AN	3/8"	11372	11387	11387
8AN	1/2"	11373	11388	11388
10AN	3/8"	11374	11389	11389
10AN	1/2"	11375	11390	11390
12AN	1/2"	11376	11391	11391
12AN	3/4"	11377	11392	11392

Male AN Flare to Male NPT 90° Swivel Adapters



Male AN Size	Male NPT Size	Part No.
3AN	1/8"	11350
4AN	1/8"	11351
4AN	1/4"	11352
6AN	1/8"	11353
6AN	1/4"	11354
6AN	3/8"	11355
8AN	1/4"	11356
8AN	3/8"	11357
8AN	1/2"	11358
10AN	3/8"	11359
10AN	1/2"	11360
12AN	1/2"	11361
12AN	3/4"	11362

Male AN Flare to Female NPT Straight Adapters



Male AN Size	Female NPT Size	Part No.
3AN	1/8"	11308
4AN	1/8"	11309

NPT Union and Tee Adapters



NPT Size	Male Pipe Union Part No.	Female Pipe Union Part No.	90° Female Pipe Adapter Part No.	45° Female to Male Pipe Adapter Part No.	90° Female to Male Pipe Adapter Part No.	Female Pipe Tee Part No.
1/8" NPT	10370	10380	11320	11330	11340	10860
1/4" NPT	10371	10381	11321	11331	11341	10861
3/8" NPT	10372	10382	11322	11332	11342	10862
1/2" NPT	10373	10383	11323	11333	11343	10863
3/4" NPT	10374	10384	--	--	--	--
1" NPT	10375	10385	--	--	--	--

Male NPT to Female NPT Reducer Adapters



Part No.	Male NPT Size	Female NPT Size
10850	1/4" NPT	1/8" NPT
10851	3/8" NPT	1/8" NPT
10852	3/8" NPT	1/4" NPT
10853	1/2" NPT	1/8" NPT
10854	1/2" NPT	1/4" NPT
10856	1/2" NPT	3/8" NPT
10855	3/4" NPT	1/4" NPT
10857	3/4" NPT	3/8" NPT
10858	3/4" NPT	1/2" NPT

Female NPT to Male NPT Tight 90° Adapter



Part No.	Female NPT Size	Male NPT Size
10825	1/8"	1/8"

Oil Restrictor Fitting Kits

Our unique Oil Restrictor Fittings allow you to limit oil flow to your turbo, minimizing the potential of damaging the oil seals.

Includes a pair of threaded jets (.030", .045", .060") to allow for customized oil flow control.

An Allen Key and Loctite are also included.



Female NPT to Male BSP Adapter



Part No.	Female NPT Size	Male BSP Size
10399	1/8"	1/8"

Part No.	Application
10287	4AN x 7/16-24 Oil Restrictor Fitting for Garrett BB Turbos
10288	3AN x 1/8" NPT Oil Restrictor Fitting Kit
10289	4AN x 1/8" NPT Oil Restrictor Fitting Kit

Billet Aluminum Dry Break Quick Release Adapters

Vibrant Performance 6061 Billet Aluminum Quick Release Fittings are very lightweight and allow for quick and easy disassembly by hand of any fluid related component, without mess or spills.

Perfect for use on oil, fuel and coolant applications. NOT FOR USE WITH BRAKE OR OTHER HYDRAULIC PRESSURE SYSTEMS.

Part No.	AN Size
20804	4AN
20806	6AN
20808	8AN
20810	10AN
20812	12AN



Male AN Flare Unions
(with 1/8" NPT Port)



Part No.	AN Size
16474	4AN
16476	6AN
16478	8AN
16480	10AN

Female AN to Male AN Flare Unions
(with 1/8" NPT Port)



Part No.	AN Size
16484	4AN
16486	6AN
16488	8AN
16490	10AN

Male AN Flare to Male NPT Unions
(with 1/8" NPT Port)



Part No.	AN Size	NPT Male
16495	6AN	1/4" NPT
16496	6AN	3/8" NPT
16497	8AN	1/4" NPT
16498	8AN	3/8" NPT

Male AN Flare 90° Unions
(with 1/8" NPT Port)



Part No.	AN Size
16536	6AN
16538	8AN

Male AN Flare Tees
(with 1/8" NPT Port)



Part No.	AN Size
16546	6AN
16548	8AN

Inverted Flare to AN Adapters



Part No.	AN Size	Inverted Flare
16435	6AN	1/2"-20
16436	6AN	5/8"-18
16438	8AN	5/8"-18

Female to Male Metric Union Extenders
(with 3 x 1/8" NPT Ports)



Part No.	Metric Size	NPT Size
10595	M12x1.5	1/8" NPT
10596	M14x1.5	1/8" NPT
10597	M16x1.5	1/8" NPT

AN Flare Caps



Part No.	AN Size
10450	3AN
10451	4AN
10452	6AN
10453	8AN
10454	10AN
10455	12AN
10456	16AN

AN Flare Hex Head Plugs



Part No.	AN Size
10440	3AN
10441	4AN
10442	6AN
10443	8AN
10444	10AN
10445	12AN
10446	16AN
10447	20AN

NPT Hex Head Plugs



Part No.	NPT Size
10880	1/8" NPT
10881	1/4" NPT
10882	3/8" NPT
10883	1/2" NPT
10884	3/4" NPT

NPT Socket Pipe Plugs



Part No.	NPT Size
10490	1/8" NPT
10491	1/4" NPT
10492	3/8" NPT
10493	1/2" NPT
10494	3/4" NPT
10495	1" NPT

Metric Port Plugs
(incl. Crush Washer)



Part No.	Plug Size
16660	M10x1.0
16661	M10x1.25
16662	M12x1.5
16663	M14x1.5
16664	M16x1.5
16665	M18x1.5

Male AN Flare to Hose Barb Straight Adapters



Part No.	AN Size	Barb Size
11207	6AN	0.375" (9.5mm)
11208	8AN	0.50" (12.7mm)
11209	10AN	0.50" (12.7mm)

Female AN Flare to Hose Barb Straight Adapters



Part No.	AN Size	Barb Size
11215	6AN	0.3125" (7.9mm)
11216	6AN	0.375" (9.5mm)
11218	8AN	0.50" (12.7mm)

Male Metric to Hose Barb Adapters (with Crush Washer)



Part No.	Metric Size	Barb Size
11410	M10x1.0	0.3125" (7.9mm)
11412	M12x1.5	0.3125" (7.9mm)
11413	M12x1.5	0.375" (9.5mm)
11414	M12x1.5	0.50" (12.7mm)
11415	M14x1.5	0.3125" (7.9mm)
11416	M14x1.5	0.375" (9.5mm)
11417	M14x1.5	0.50" (12.7mm)

Male NPT to Hose Barb Adapters



Straight Adapter



45° Adapter



90° Adapter

NPT Size	Barb Size	Straight Adapter Part No.	45° Adapter Part No.	90° Adapter Part No.
1/8" NPT	0.25" (6.4mm)	11200	11220	11230
1/4" NPT	0.375" (9.5mm)	11201	11221	11231
3/8" NPT	0.375" (9.5mm)	11205	11225	11235
3/8" NPT	0.50" (12.7mm)	11202	11222	11232
1/2" NPT	0.625" (15.9mm)	11203	11223	11233
3/4" NPT	0.75" (19.1mm)	11204	11224	11234

Male Barbed Push-On Adapters



Part No.	Hose Size
11240	4AN (1/4" x 1/4")
11241	6AN (3/8" x 3/8")
11242	8AN (1/2" x 1/2")
11243	10AN (5/8" x 5/8")
11244	12AN (3/4" x 3/4")
11245	6AN x 8AN (3/8" x 1/2")
11246	8AN x 10AN (1/2" x 5/8")
11247	10AN x 12AN (5/8" x 3/4")

Inline Barbed Union Adapters (with 1/8" NPT Female Port)

Part No.	Barb Size
16470	0.3125" (7.9mm)
16471	0.375" (9.5mm)



Hose Barb Weld-On Bungs (6061 Aluminum and Mild Steel)

Barb Size	Aluminum Part No.	Mild Steel Part No.
0.25" (6.4mm)	11180	11280
0.375" (9.5mm)	11181	11281
0.50" (12.7mm)	11182	11282
0.625" (15.9mm)	11183	11283
0.75" (19.1mm)	11184	11284



Male AN Flare Weld Bungs



Male AN Size	Flange O.D.	Aluminum Part No.	Mild Steel Part No.
4AN	0.75" (19.1mm)	11150	11250
6AN	0.875" (22.2mm)	11151	11251
8AN	1.00" (25.4mm)	11152	11252
10AN	1.125" (28.6mm)	11153	11253
12AN	1.375" (34.9mm)	11154	11254
16AN	1.625" (41.3mm)	11155	11255
20AN	1.75" (44.5mm)	11156	11256

Female AN Weld Bungs (Straight Thread)



Female AN Size	Bung O.D.	Aluminum Part No.	Mild Steel Part No.
4AN	0.75" (19.1mm)	11160	--
6AN	0.875" (22.2mm)	11161	11261
8AN	1.00" (25.4mm)	11162	11262
10AN	1.125" (28.6mm)	11163	11263
12AN	1.375" (34.9mm)	11164	--
16AN	1.625" (41.3mm)	11165	--

Female NPT Weld Bungs

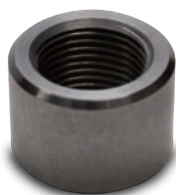

Female NPT Size	Bung O.D.	Aluminum Part No.	Mild Steel Part No.
1/8" NPT	0.75" (19.1mm)	11170	11270
1/4" NPT	0.875" (22.2mm)	11171	11271
3/8" NPT	1.00" (25.4mm)	11172	11272
1/2" NPT	1.25" (31.75mm)	11173	11273
3/4" NPT	1.375" (34.9mm)	11174	11274
1" NPT	1.625" (41.3mm)	11175	--

Tank Weld Bungs with Thread on Cap

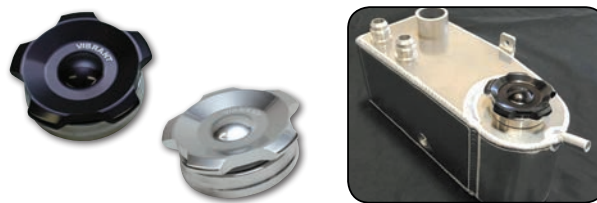

Weld Bung O.D.	Weld Bung Material	Thread-on Cap Color	Part No.
2.00" (50.8mm)	Aluminum	Polished	11290
2.00" (50.8mm)	Aluminum	Anodized Black	11291
2.75" (69.9mm)	Aluminum	Polished	11294
2.75" (69.9mm)	Aluminum	Anodized Black	11295
2.75" (69.9mm)	Mild Steel	Polished	11296
2.75" (69.9mm)	Mild Steel	Anodized Black	11297

Aluminum Weld-On Radiator Filler Necks and Radiator Caps



Weld Fitting

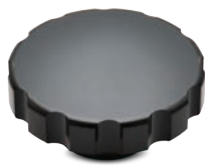

Cap

Filler Neck Part No.	Filler Neck Size	Matching Rad Cap Part No.
20980	1.25" (31.8mm)	20981
20982	1.65" (41.9mm)	20983

Chevy LS Engine Oil Pressure Adapter



Part No. **16790**

This oil pressure adapter fitting allows you to retain the factory oil pressure switch (with M16 x 1.5 thread) while running an oil reference port to your turbo or any related accessory (e.g. oil pressure gauge). Includes three crush washers.

1/8" NPT thread on Banjo.

Chevy LS Engine Fuel Pressure Adapter



Part No. **16791**

This convenient new adapter fitting allows you to install an aftermarket fuel pressure gauge to your LS Engine's factory fuel rail (must remove Schrader valve).

Features Female 4AN thread on one end and Female 1/8" NPT thread on the other, making it useful for many other applications as well.

Inline Oil / Fuel Filter Sets

This unique, flow directional Oil/Fuel Filter kit includes a Male AN Flare Outlet Adapter, as well as both a Male and Female Inlet Adapters.

Included in each set are interchangeable 30, 80 and 150 micron filter elements.



Part No.	AN Size
16733	3AN
16734	4AN
16736	6AN
16738	8AN

Please Note:

- 30 micron element is best suited for lightweight engine oil or pump gas.
- 80 micron element is recommended for heavy-weight engine oil, diesel, alcohol or ethanol fuel.
- 150 micron element is for use with power steering and transmission oil.

Male AN Flare to Male AN Flare Flapper Style One Way Check Valves



Part No.	AN Size
11187	6AN
11190	8AN
11191	10AN
11192	12AN
11196	16AN

Female ORB to Male AN Flare Ball Style Inline One Way Check Valves



Part No.	Male AN Size	Female ORB Size
11116	6AN	9/16" -18
11118	8AN	3/4" -16

Male AN Flare to Male Metric EFI Fuel Pump Check Valves (incl. Crush Washer)



Part No.	AN Size	Metric
11198	6AN	M12x1.5
11199	8AN	M12x1.5

Male AN Flare In-Tank Rollover Valves (incl. washer)



Part No.	AN Size
16716	6AN
16718	8AN
16720	10AN
16722	12AN

Fuel Cell Bulkhead Adapters (incl. Washers and Bulkhead Nut)



Part No.	AN Size
16892	6AN
16893	8AN
16894	10AN
16895	12AN
16896	16AN

Billet Aluminum Y-Block Adapters (with 1/8" NPT Port)



Part No.	Single NPT	Dual NPT
10820	3/8" NPT	3/8" NPT
10821	1/2" NPT	3/8" NPT
10822	1/2" NPT	1/2" NPT

One Piece 60° Y Adapters



Part No.	Size	Part No.	Size
10803	3AN x dual 3AN	10809	10AN x dual 8AN
10814	4AN x dual 3AN	10810	10AN x dual 10AN
10804	4AN x dual 4AN	10813	12AN x dual 8AN
10805	6AN x dual 4AN	10811	12AN x dual 10AN
10806	6AN x dual 6AN	10812	12AN x dual 12AN
10807	8AN x dual 6AN	10818	1/8" NPT x dual 3AN
10808	8AN x dual 8AN		

Push-On EFI Adapters



Part No.	AN Size	Hose Size
16880	6AN	0.3125" (7.9mm)
16881	6AN	0.375" (9.5mm)
16882	8AN	0.375" (9.5mm)

Quick Disconnect EFI Adapters



Part No.	AN Size	EFI Line Size
16885	6AN	0.3125" (7.9mm)
16886	6AN	0.375" (9.5mm)
16887	8AN	0.375" (9.5mm)

Aluminum Hard Lines



Ideal for fuel, oil and water service. Flare the tube with a 37° flaring tool so these hard lines can be used with Vibrant Performance Tube Nuts and Sleeves.

Part No.	Description	Quantity
16410	0.3125" (7.9mm) Aluminum Hard Line	25 ft. (7.62m) spool
16411	0.375" (9.5mm) Aluminum Hard Line	25 ft. (7.62m) spool
16412	0.50" (12.7mm) Aluminum Hard Line	25 ft. (7.62m) spool
16413	0.625" (15.9mm) Aluminum Hard Line	25 ft. (7.62m) spool

Hardline Cutting Tool

Cuts through Steel, Copper, Aluminum and Plastic tubing with ease and without distortion. For use on tubing measuring from 0.125" (3.175mm) to 1.125" (28.5mm).



Part No. 2991

Tube to Female AN Adapters (incl. hardline brass olive)



Part No.	AN Size	Tube Size
16445	6AN	0.3125" (7.9mm)
16446	6AN	0.375" (9.5mm)
16448	8AN	0.50" (12.7mm)

Tube to Male AN Flare Adapters (incl. hardline brass olive)



Part No.	AN Size	Tube Size
16455	6AN	0.3125" (7.9mm)
16456	6AN	0.375" (9.5mm)
16458	8AN	0.50" (12.7mm)

Tube Sleeves



Part No.	AN Size	Use with Tube Size
10760	3AN	0.1875" (4.8mm)
10761	4AN	0.25" (6.4mm)
10762	6AN	0.375" (9.5mm)
10763	8AN	0.50" (12.7mm)
10764	10AN	0.625" (15.9mm)
10765	12AN	0.75" (19mm)
10766	16AN	1.00" (25.4mm)

Tube Nuts



Part No.	AN Size	Use with Tube Size
10750	3AN	0.1875" (4.8mm)
10751	4AN	0.25" (6.4mm)
10752	6AN	0.375" (9.5mm)
10753	8AN	0.50" (12.7mm)
10754	10AN	0.625" (15.9mm)
10755	12AN	0.75" (19mm)
10756	16AN	1.00" (25.4mm)

Replacement Hardline Brass Olive Inserts



Part No.	Use with Tube Size	Package Quantity
16465	0.3125" (7.9mm)	5 / pack
16466	0.375" (9.5mm)	5 / pack
16468	0.50" (12.7mm)	5 / pack

Universal Baffled Catch Can Assemblies



Part No.	Color	Recirculation Type
12694	Silver	Open loop with filter
12695	Black	Open loop with filter
12696	Silver	Recirculating closed loop
12697	Black	Recirculating closed loop

Vibrant Performance has developed a pair of new Universal, Internally Baffled Catch Can assemblies.

Our "OPEN LOOP" design features a recessed Stainless Steel Filter Element, and comes with two (2) Male 10AN Flare fittings integrated into the Catch Can's top end cap.

The "CLOSED LOOP" design is designed for vehicles equipped with MAF Sensors. It features four (4) Male 10AN Flare fittings integrated into the top cap.

All of our new Catch Can Assemblies share the following features:

- 6061 aluminum construction.
- Available in anodized black or anodized silver finish.
- Tank Size: 4.00" (101.6mm) O.D. x 8.00" (203.2mm) tall.
- Internally baffled to improve oil vapor capture and collection while preventing particulate from escaping.
- 8AN drain plug integrated into bottom for easy draining or can be adapted as a return feed to the oil pan.
- 304 stainless steel mounting bracket that can be clocked 360° to provide infinite mounting position options.
- Dip stick included to easily check fluid levels.
- Compatible with Vibrant Performance Fittings and Hoses.

TECH TIP

Recommended Setup for Open Loop Model

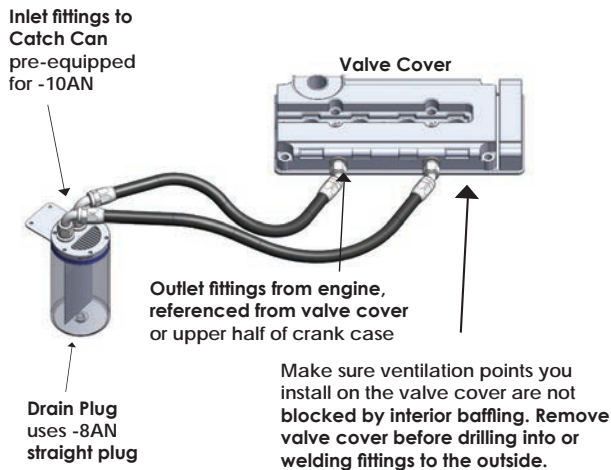

The Vibrant vented catch can is a perfect solution for cars with a MAP sensor based tuning system that need to expel crankcase pressure. The large 10AN fittings in the top cap will allow for ample flow out of the engine to the baffled catch can.

Recommended Setup for Close Loop Model

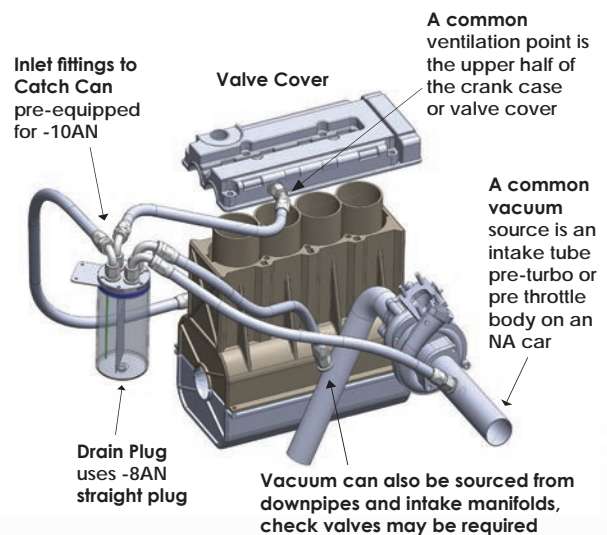

The Vibrant Performance Closed Loop Catch Can is a perfect solution for cars with a MAF sensor based tuning system that also need to remedy crank case pressure. MAF sensor based cars usually require closed loop catch cans to keep the metered air that has passed through the MAF from escaping the tune. The included large 10AN fittings ensure ample flow in and out of the Vibrant Catch Can.

Aluminum Vacuum Manifold

Vibrant's popular Aluminum Vacuum Manifold allows for consistent vacuum from a single source to be distributed through up to 6 ports.



- Includes mounting hardware and port plugs.
- Central Port threaded for 3/8" NPT fittings.
- All six outlet ports threaded for 1/8" NPT fittings.

Part No.	NPT Thread Size	Length	Width	Height	Color
2690	6 x 1/8" NPT & 1 x 3/8" NPT	5.50" (139.7mm)	1.50" (38.1mm)	1.00" (25.4mm)	Anodized Silver
2691	6 x 1/8" NPT & 1 x 3/8" NPT	5.50" (139.7mm)	1.50" (38.1mm)	1.00" (25.4mm)	Anodized Black

Pneumatic Push Lock Vacuum Fittings

Vibrant Performance One Touch Fittings allow for simple and highly secure tube connections and are suitable for both ambient and pressurized air. Your vacuum tubing quickly disconnects from the fitting by simply pushing down on the release collar.

All threads are PTFE coated. Maximum Pressure 150 PSI.

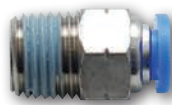

Male Straight

Part No.	Male NPT Thread Size	O.D. Tube Size
2660	1/8" NPT	0.156" (3.97mm)
2662	1/8" NPT	0.25" (6.4mm)
2661	1/8" NPT	0.375" (9.5mm)
2664	1/4" NPT	0.25" (6.4mm)
2663	1/4" NPT	0.375" (9.5mm)



Male 90° Swivel Elbow

Part No.	Male NPT Thread Size	O.D. Tube Size
2665	1/8" NPT	0.156" (3.97mm)
2667	1/8" NPT	0.25" (6.4mm)
2666	1/8" NPT	0.375" (9.5mm)
2669	1/4" NPT	0.25" (6.4mm)
2668	1/4" NPT	0.375" (9.5mm)
2655	3/8" NPT	0.25" (6.4mm)
2653	1/2" NPT	0.25" (6.4mm)



Union Y

Part No.	O.D. Tube Size
2680	0.156" (3.97mm)
2682	0.25" (6.4mm)
2681	0.375" (9.5mm)



Union Straight

Part No.	O.D. Tube Size
2670	0.156" (3.97mm)
2672	0.25" (6.4mm)
2671	0.375" (9.5mm)



Union Tee

Part No.	O.D. Tube Size
2675	0.156" (3.97mm)
2677	0.25" (6.4mm)
2676	0.375" (9.5mm)

Polyethylene Vacuum Tubing

Ideal for air lines and instrumentation. Withstands up to 100 PSI and is suitable for use at temperatures up to 140° F (60°C).

Part No.	O.D. Tube Size	Quantity	Color
2650	0.156" (3.97mm)	10.00'	Black
2652	0.25" (6.4mm)	10.00'	Black
2683	0.25" (6.4mm)	10.00'	Clear
2651	0.375" (9.5mm)	10.00'	Black



Billet Aluminum Line Separators

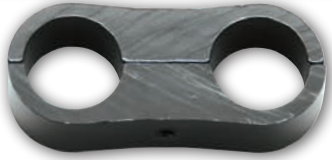

Part No.	Hole Size	Use with AN Hose Size
20605	0.19" (4.8mm)	--
20606	0.25" (6.4mm)	--
20608	0.31" (7.9mm)	--
20609	0.38" (9.5mm)	--
20611	0.43" (11.1mm)	4AN
20612	0.50" (12.7mm)	--
20613	0.53" (13.5mm)	--
20614	0.56" (14.2mm)	6AN
20616	0.63" (15.9mm)	--
20617	0.66" (16.8mm)	--
20618	0.69" (17.5mm)	8AN
20619	0.75" (19.1mm)	--
20620	0.81" (20.6mm)	10AN
20622	0.88" (22.2mm)	--
20624	0.94" (23.9mm)	12AN
20625	1.00" (25.4mm)	--

Clean Cut Adhesive Tape

Vibrant Performance Clean Cut Adhesive tape allows you to make clean and professional cuts of Braided Flex Hoses with virtually no fraying.

Use our White Adhesive Tape (#2970) for cutting Stainless Steel Braided Hose.

When cutting Nylon Braided Hose, first wrap a layer of Clear Tape (#2971) where you plan to make your cut, followed by a layer of the White Adhesive Tape (#2970).



Part No. 2970



Part No. 2971

Hose Cutting Shears

- These heavy duty hose shears are ideal for achieving easy, clean cuts to Braided and Non-Braided Flex Hoses.
- For use on 3AN to 20AN hoses.



Part No. 2989

Small Diameter Hose Clamps

Vibrant Performance offers a wide variety of small diameter hose clamps, ideal for securing virtually any type and size of commonly used flexible hose.

Please refer to page 40 for a full application chart of available sizes.



Stainless Steel Cushioned P-Clamps

Secure your hose lines with these lightweight stainless steel P-Clamps, lined with neoprene rubber cushioning.



Stainless Steel Pinch Clamps

These 300 series Stainless Steel pinch clamps provides 360 degree sealing with no gaps. The smooth inner band avoids hose damage.



Fuel Injector Style Mini Hose Clamps

These zinc plated mild steel clamps feature rounded edges to ensure the clamp grips firmly without cutting your hose.

Ideal for fuel, vacuum and washer fluid lines.

Billet Aluminum AN Wrenches



Part No.	Wrench Size
20904	4AN
20906	6AN
20908	8AN
20910	10AN
20912	12AN
20916	16AN
20989	Set of 6 Wrenches (4AN to 16AN)

Magnetic Billet Aluminum Vise Jaws

Vibrant Performance Billet Aluminum Vice Jaws securely hold your fittings without risk of damaging the high lustre anodized finish during assembly. The backside of these jaws have magnets built into them to hold them firmly in place in your vise.



Part No. 20990

Aluminum Crush Washers



Part No.	Description	Size
20923	Pack of 10 Aluminum Crush Washers	3AN (10mm)
20924	Pack of 10 Aluminum Crush Washers	4AN (11mm)
20926	Pack of 10 Aluminum Crush Washers	6AN (14mm)
20928	Pack of 10 Aluminum Crush Washers	8AN (18mm)
20930	Pack of 10 Aluminum Crush Washers	10AN (22mm)
20932	Pack of 10 Aluminum Crush Washers	12AN (27mm)
20936	Pack of 10 Aluminum Crush Washers	16AN (33mm)
20998	Box Set, Aluminum Crush Washers Contains 10 of each size	3AN to 16AN

Billet Aluminum Adjustable AN Wrenches



Part No.	Description
20993	Adjustable AN Wrench, 4AN to 16AN



Part No.	Description
20992	Adjustable AN Wrench, 3AN to 12AN

Hose End Fitting Installation Toolkit

This handy toolkit simplifies the process of installing flexible braided hoses to reusable hose end fittings.

Includes Clamping Tool, steel jigs for AN sizes -4 through -12, a set of Aluminum Vice Jaws and comes complete in a convenient carry case.



Part No. 2992

FKM Rubber O-Rings



Part No.	Description	Size
20883	Pack of 10 Rubber O-Rings	3AN
20884	Pack of 10 Rubber O-Rings	4AN
20886	Pack of 10 Rubber O-Rings	6AN
20888	Pack of 10 Rubber O-Rings	8AN
20890	Pack of 10 Rubber O-Rings	10AN
20892	Pack of 10 Rubber O-Rings	12AN
20896	Pack of 10 Rubber O-Rings	16AN
20999	Box Set, Rubber O-Rings Contains 10 of each washer	3AN to 16AN

Oil Feed Flanges

- Features 6061 Aluminum construction.
- Includes a pair of M8 x 1.25 bolts for easy installation.
- All flanges tapped for 1/8" NPT Fittings

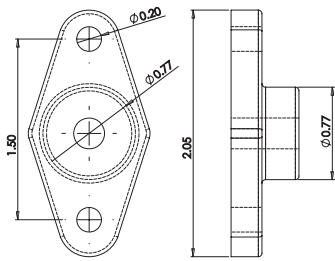

Part No. 2899

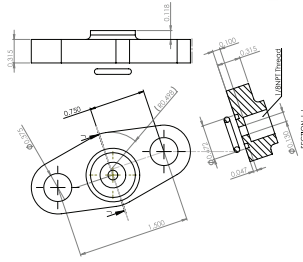

Part No. 19874

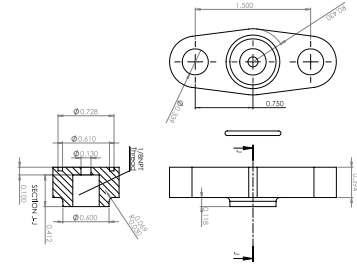

Part No. 19875

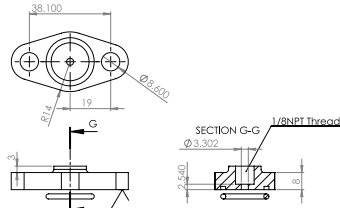

Part No. 19876

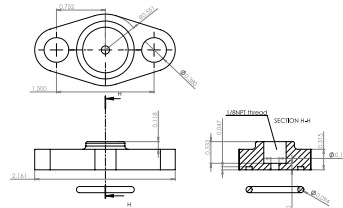

Part No. 19879

Application	Flange Part No.	Gasket Part No.
Garrett GT3271R and generic T3, T3/T4 and T4	2899	2899G
Garrett GT37 and GT40 (includes NBR Rubber O-Ring)	19876	O-Ring Included
Garrett GT42 and GT45 (includes NBR Rubber O-Ring)	19875	O-Ring Included
Garrett GT/GTX47, GTX50 and GT/GTX55 (includes NBR Rubber O-Ring)	19874	O-Ring Included
Oil Feed Flange for Garrett GT6041 (includes NBR Rubber O-Ring)	19879	O-Ring Included

Universal Oil Feed Line Assemblies

All Vibrant Performance Oil Feed Kits include a PTFE lined Stainless Steel Flexible Hose and high quality AN Hose End Fittings.

Part No.	Hose Length	Female Hose End Size
10270	24" (610mm)	3AN
10271	36" (915mm)	3AN
10272	48" (1.22m)	3AN
10275	24" (610mm)	4AN
10276	36" (915mm)	4AN
10277	48" (1.22m)	4AN



Universal Oil Drain Kits

Vibrant Performance Universal Oil Drain Kits include a 10AN Stainless Steel Flexible Hose, 10AN Aluminum Fittings, 10AN Oil Pan Weld Bungs (both Steel and Aluminum Bungs are included) and an Aluminum Oil Drain Flange.

Part No.	Description
10280	Oil Drain Kit with 12" long Flex Hose and Oil Drain Flange for T3/T4 Turbos
10281	Oil Drain Kit with 12" long Flex Hose and Oil Drain Flange for GT15- GT35 Turbos
10282	Oil Drain Kit for Top Mount setups with 20" long Flex Hose and Oil Drain Flange for T3/T4 Turbos
10283	Oil Drain Kit for Top Mount setups with 20.00" long Flex Hose and Oil Drain Flange for GT15-GT35 Turbos



Oil Drain Flanges

- Features T6061 Aluminum construction
- Includes a pair of M8 x 1.25 bolts for easy installation

Oil Drain Flanges (Tapped for 1/2" NPT Fittings)

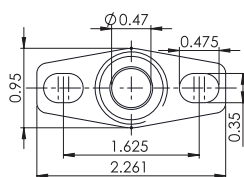

Part No. 2889

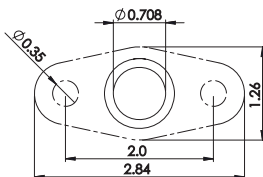

Part No. 2853

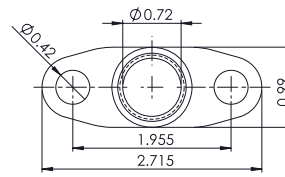

Part No. 2898

Application	Flange Part No.	Gasket Part No.
Garrett GT15, GT20, GT22, GT25, GT28, GT30 and GT35 and Borg Warner EFR 6258, 6758, 7064, 7163 and 7670 (all types)	2889	2889G
Garrett GT37, GT40, GT42, GT45, GT47, GT50 and GT55	2853	2853G
Garrett GT3271R and generic T3, T3/T4 and T4	2898	2898G

Oil Drain Flanges (with integrated 10AN Male Flare)

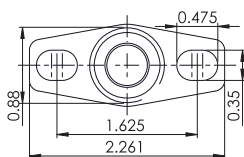

Part No. 2893

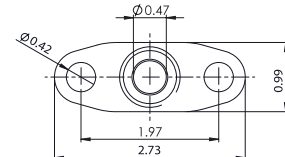

Part No. 2849

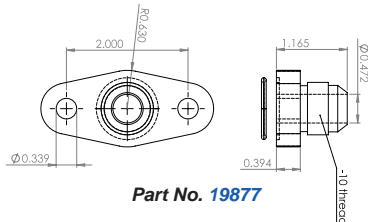

Part No. 19877

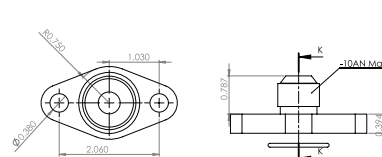

Part No. 19880

Application	Flange Part No.	Gasket Part No.
Garrett GT15, GT20, GT22, GT25, GT28, GT30 and GT35 and Borg Warner EFR 6258, 6758, 7064, 7163 and 7670 (all types)	2893	2893G
Garrett GT37, GT40, GT42, GT45, GT47, GT50 and GT55 (includes NBR Rubber O-Ring)	19877	O-Ring Included
Garrett GT3271R and generic T3, T3/T4 and T4	2849	2849G
Garrett GT6041 (includes NBR Rubber O-Ring)	19880	O-Ring Included

Oil Drain Flanges (with integrated 5/8" Male Barb)

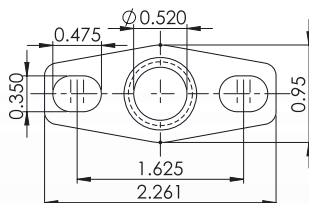
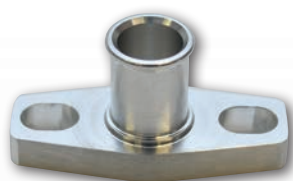

Part No. 2894

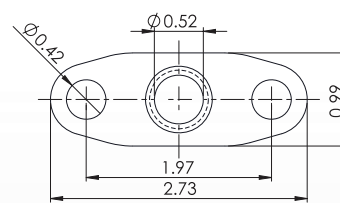

Part No. 2850

Application	Flange Part No.	Gasket Part No.
Garrett GT15, GT20, GT22, GT25, GT28, GT30 and GT35 and Borg Warner EFR 6258, 6758, 7064, 7163 and 7670 (all types)	2894	2893G
Garrett GT3271R and generic T3, T3/T4 and T4	2850	2849G



induction

For more than a decade, Vibrant Performance has offered the most extensive collection of Professional Fabrication Components to complete nearly any air induction related project. If you need it, we probably have it in stock so you can get the job done.

Our diverse range of induction fabrication components is highlighted by our popular HD Clamp Systems, which take modular, flexible connectors to a whole new level. We also offer premium quality Bar and Plate Intercoolers and Oil Coolers, 6061 Aluminum Mandrel Bends and Straight Tubing, High Temp Aramid Reinforced Silicone Couplings, a wide variety of Hose Clamp solutions, High Flow Air Filters and a Manual Boost Controller, plus so much more.

All of these track tested components deliver a potent combination of outstanding quality at a great value, making professional fabrication solutions affordable and accessible to all.

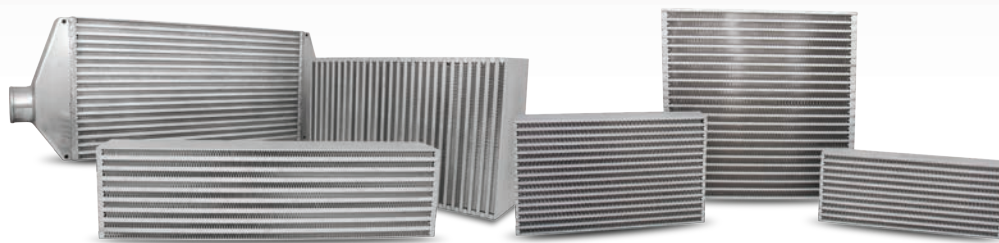

Intercoolers and Oil Coolers

Vibrant Performance Bar and Plate Intercoolers and Oil Coolers feature a unique, louvered fin design on the ambient path, which maximizes the core's available surface area, and an offset fin design on the charge air path for minimal pressure loss.

Our cores also feature industry leading fin density that vastly improves cooling efficiency, allowing for lowered charged air temperatures, maximizing charge air density gains.

Air to Air Intercooler Assemblies (with End Tanks)

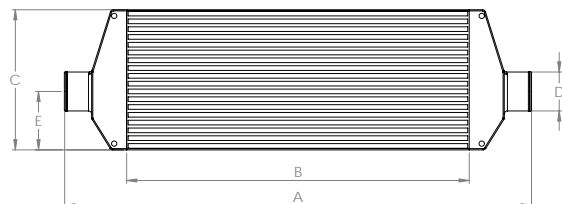

* Each Vibrant Performance Intercooler Assembly includes a pair of Stainless Steel Easy Mount Brackets which bolt to the end tanks, making mounting the intercooler easy.

Part No.	Overall Length (Dim. A)	Core Width (Dim. B)	Height (Dim. C)	Inlet / Outlet (Dim. D)	(Dim. E)	Inlet/Outlet Neck Length	Core Thickness	Matching Bracket Kits
12800	26.00" (660mm)	18.00" (457.2mm)	6.50" (165.1mm)	2.50" (63.5mm)	3.25" (82.6mm)	1.75" (44.5mm)	3.25" (82.6mm)	12827
12810	30.00" (762mm)	22.00" (558.8mm)	9.00" (228.6mm)	2.50" (63.5mm)	3.50" (88.9mm)	1.75" (44.5mm)	3.25" (82.6mm)	12828
12815	33.00" (838mm)	23.50" (597mm)	12.00" (304.8mm)	3.00" (76.2mm)	4.50" (114.3mm)	1.75" (44.5mm)	3.50" (88.9mm)	12829

Horizontal Flow Air to Air Intercooler Cores

Part No.	Core Thickness	Core Width	Height
12830	3.25" (82.6mm)	17.75" (450.9mm)	6.50" (165.1mm)
12831	3.25" (82.6mm)	22.00" (558.8mm)	9.25" (235mm)
12833	3.50" (88.9mm)	17.75" (450.9mm)	9.85" (250.2mm)
12835	3.50" (88.9mm)	20.00" (508mm)	11.00" (279.4mm)
12836	3.50" (88.9mm)	22.00" (558.8mm)	5.90" (149.9mm)
12839	3.50" (88.9mm)	24.00" (609.6mm)	8.00" (203.2mm)
12832	3.50" (88.9mm)	25.00" (635mm)	11.80" (299.7mm)
12834	4.50" (114.3mm)	17.75" (450.9mm)	11.80" (299.7mm)
12837	4.00" (101.6mm)	22.00" (558.8mm)	9.85" (250.2mm)
12838	4.50" (114.3mm)	22.00" (558.8mm)	11.80" (299.7mm)
12840	4.50" (114.3mm)	27.50" (698.5mm)	9.85" (250.2mm)
12844	6.00" (152.4mm)	18.00" (457.2mm)	12.00" (304.8mm)

Vertical Flow Air to Air Intercooler Cores

Part No.	Core Thickness	Core Width	Height
12841	3.00" (76.2mm)	6.00" (152.4mm)	11.80" (299.7mm)
12857	3.50" (88.9mm)	12.00" (304.8mm)	8.00" (203.2mm)
12850	3.50" (88.9mm)	12.00" (304.8mm)	12.00" (304.8mm)
12855	3.50" (88.9mm)	18.00" (457.2mm)	6.00" (152.4mm)
12856	3.50" (88.9mm)	24.00" (609.6mm)	6.00" (152.4mm)
12859	3.50" (88.9mm)	24.00" (609.6mm)	8.00" (203.2mm)
12851	3.50" (88.9mm)	30.00" (762mm)	10.00" (254mm)
12853	4.50" (114.3mm)	22.00" (558.8mm)	14.00" (355.6mm)
12852	4.50" (114.3mm)	27.00" (685.8mm)	6.00" (152.4mm)
12854	4.50" (114.3mm)	30.00" (762mm)	12.00" (304.8mm)
12862	6.00" (152.4mm)	18.00" (457.2mm)	12.00" (304.8mm)
12866	6.00" (152.4mm)	22.00" (558.8mm)	11.00" (279.4mm)

Oil Cooler Cores

Part No.	Core Thickness	Core Width	Height
12893	1.25" (31.8mm)	10.00" (254mm)	4.00" (101.6mm)
12894	2.00" (50.8mm)	10.00" (254mm)	4.00" (101.6mm)
12896	2.00" (50.8mm)	10.00" (254mm)	6.00" (152.4mm)
12895	2.00" (50.8mm)	12.00" (304.8mm)	4.00" (101.6mm)
12897	2.00" (50.8mm)	12.00" (304.8mm)	12.00" (304.8mm)

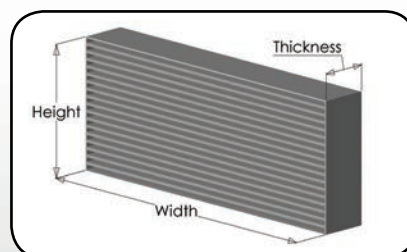



Aluminum Tubing

Vibrant Performance offers a vast range of Aluminum tubing products, including mandrel bends, straight tubing, joiners and transitions, all made from top quality, lightweight and mirror polished 6061 Aluminum, in sizes ranging from 0.75" (19mm) to 5" (127mm) OD.

Vibrant Performance Aluminum tubing requires virtually no surface preparation prior to welding, making it the preferred choice of professional fabricators across many different industries. Make us your first choice for your next project!

180° Aluminum Bends

Part No.	Tube O.D.	CLR	Leg Length
2863	1.50" (38.1mm)	2.25" (57.2mm)	4.00" (101.6mm)
2864	1.75" (44.5mm)	2.25" (57.2mm)	4.00" (101.6mm)
2865	2.00" (50.8mm)	2.50" (63.5mm)	4.00" (101.6mm)
2867	2.50" (63.5mm)	3.75" (95.3mm)	3.50" (88.9mm)
2868	2.75" (69.9mm)	4.125" (104mm)	3.50" (88.9mm)
2869	3.00" (76.2mm)	4.50" (114.3mm)	2.50" (63.5mm)

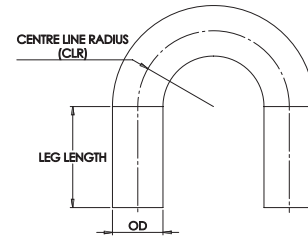

120° Aluminum Bends

Part No.	Tube O.D.	CLR	Leg Length
2154	1.50" (38.1mm)	2.25" (57.2mm)	4.00" (101.6mm)
2155	1.75" (44.5mm)	2.25" (57.2mm)	4.00" (101.6mm)
2823	2.00" (50.8mm)	2.50" (63.5mm)	4.00" (101.6mm)
2824	2.25" (57.2mm)	2.55" (65.5mm)	4.00" (101.6mm)
2825	2.50" (63.5mm)	3.75" (95.3mm)	3.00" (76.2mm)
2826	2.75" (69.9mm)	4.125" (104mm)	3.00" (76.2mm)
2827	3.00" (76.2mm)	4.50" (114.3mm)	2.50" (63.5mm)
2828	3.50" (88.9mm)	4.75" (120.7mm)	2.50" (63.5mm)
2829	4.00" (101.6mm)	4.50" (114.3mm)	2.50" (63.5mm)

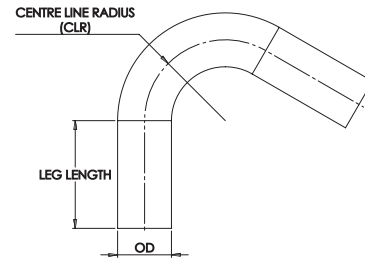

90° Aluminum Bends

Part No.	Tube O.D.	CLR	Leg Length
2114	0.75" (19.0mm)	1.15" (29.2mm)	4.00" (101.6mm)
2117	1.00" (25.4mm)	1.15" (29.2mm)	4.00" (101.6mm)
2158	1.50" (38.1mm)	2.25" (57.2mm)	4.00" (101.6mm)
2159	1.75" (44.5mm)	2.25" (57.2mm)	4.00" (101.6mm)
2884	2.00" (50.8mm)	2.50" (63.5mm)	4.50" (114.3mm)
2887	2.25" (57.2mm)	2.55" (65.5mm)	4.50" (114.3mm)
2178	2.50" (63.5mm)	3.75" (95.3mm)	3.00" (76.2mm)
2881	2.75" (69.9mm)	4.125" (104mm)	3.00" (76.2mm)
2176	3.00" (76.2mm)	4.50" (114.3mm)	2.50" (63.5mm)
2891	3.50" (88.9mm)	4.50" (114.3mm)	2.50" (63.5mm)
2876	4.00" (101.6mm)	5.00" (127mm)	2.00" (50.8mm)
2946	4.50" (114.3mm)	6.75" (171.5mm)	4.00" (101.6mm)
2976	5.00" (127mm)	7.00" (177.8mm)	4.00" (101.6mm)

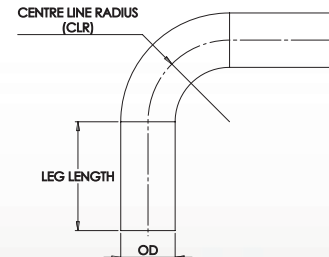

60° Aluminum Bends

Part No.	Tube O.D.	CLR	Leg Length
2152	1.50" (38.1mm)	2.25" (57.2mm)	6.00" (152.4mm)
2153	1.75" (44.5mm)	2.25" (57.2mm)	6.00" (152.4mm)
2814	2.00" (50.8mm)	2.50" (63.5mm)	6.00" (152.4mm)
2816	2.25" (57.2mm)	2.55" (65.5mm)	6.00" (152.4mm)
2817	2.50" (63.5mm)	3.75" (95.3mm)	6.00" (152.4mm)
2818	2.75" (69.9mm)	4.125" (104mm)	6.00" (152.4mm)
2819	3.00" (76.2mm)	4.50" (114.3mm)	6.00" (152.4mm)
2821	3.50" (88.9mm)	4.50" (114.3mm)	5.50" (139.7mm)
2822	4.00" (101.6mm)	4.50" (114.3mm)	5.50" (139.7mm)

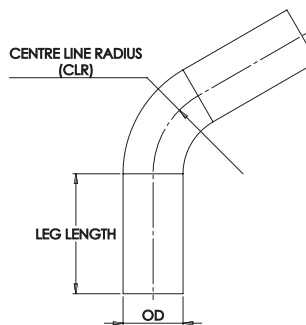

45° Aluminum Bends

Part No.	Tube O.D.	CLR	Leg Length
2115	0.75" (19.0mm)	1.15" (29.2mm)	4.00" (101.6mm)
2118	1.00" (25.4mm)	1.15" (29.2mm)	4.00" (101.6mm)
2156	1.50" (38.1mm)	2.25" (57.2mm)	6.00" (152.4mm)
2157	1.75" (44.5mm)	2.25" (57.2mm)	6.00" (152.4mm)
2883	2.00" (50.8mm)	2.50" (63.5mm)	6.00" (152.4mm)
2886	2.25" (57.2mm)	2.55" (65.5mm)	6.00" (152.4mm)
2177	2.50" (63.5mm)	3.75" (95.3mm)	6.00" (152.4mm)
2880	2.75" (69.9mm)	4.125" (104mm)	6.00" (152.4mm)
2175	3.00" (76.2mm)	4.50" (114.3mm)	6.00" (152.4mm)
2890	3.50" (88.9mm)	4.50" (114.3mm)	5.50" (139.7mm)
2875	4.00" (101.6mm)	4.50" (114.3mm)	5.50" (139.7mm)
2945	4.50" (114.3mm)	6.75" (171.5mm)	4.00" (101.6mm)
2975	5.00" (127mm)	7.00" (177.8mm)	4.00" (101.6mm)

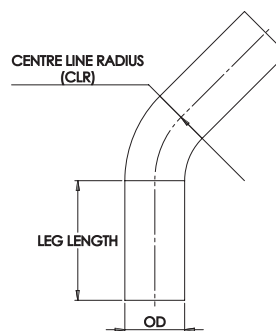

30° Aluminum Bends

Part No.	Tube O.D.	CLR	Leg Length
2150	1.50" (38.1mm)	2.25" (57.2mm)	6.50" (165.1mm)
2151	1.75" (44.5mm)	2.25" (57.2mm)	6.50" (165.1mm)
2806	2.00" (50.8mm)	2.50" (63.5mm)	6.50" (165.1mm)
2808	2.50" (63.5mm)	3.75" (95.3mm)	6.50" (165.1mm)
2809	2.75" (69.9mm)	4.125" (104mm)	6.00" (152.4mm)
2811	3.00" (76.2mm)	4.50" (114.3mm)	6.00" (152.4mm)
2812	3.50" (88.9mm)	4.50" (114.3mm)	5.50" (139.7mm)
2813	4.00" (101.6mm)	4.50" (114.3mm)	5.50" (139.7mm)

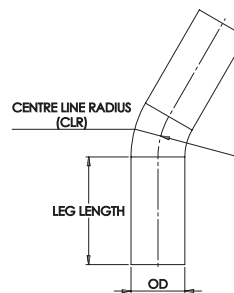

Aluminum Transitions – 3" Overall Length

Part No.	Small O.D.	Large O.D.
12061	2.00" (50.8mm)	2.50" (63.5mm)
12064	2.50" (63.5mm)	2.75" (69.9mm)
12065	2.50" (63.5mm)	3.00" (76.2mm)
12067	3.00" (76.2mm)	3.50" (88.9mm)
12069	3.50" (88.9mm)	4.00" (101.6mm)

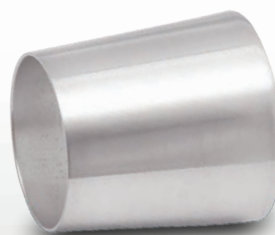

Aluminum Straight Tubing – 18" Overall Length

Part No.	Tube O.D.
2116	0.75" (19.0mm)
2119	1.00" (25.4mm)
2171	1.50" (38.1mm)
2172	1.75" (44.5mm)
2885	2.00" (50.8mm)
2888	2.25" (57.2mm)
2174	2.50" (63.5mm)
2882	2.75" (69.9mm)
2173	3.00" (76.2mm)
2892	3.50" (88.9mm)
2877	4.00" (101.6mm)
2947	4.50" (114.3mm)
2977	5.00" (127mm)



Aluminum Joiners – 3" Overall Length

Part No.	Tube O.D.
12046	1.00" (25.4mm)
12047	1.25" (31.8mm)
12049	1.50" (38.1mm)
12048	1.75" (44.5mm)
12050	2.00" (50.8mm)
12051	2.25" (57.2mm)
12052	2.50" (63.5mm)
12053	2.75" (69.9mm)
12054	3.00" (76.2mm)
12055	3.50" (88.9mm)
12056	4.00" (101.6mm)



Tight Radius Cast Aluminum Elbows



Part No.	Elbow O.D.	CLR	Leg Length
2872	2.00" (50.8mm)	1.57" (39.9mm)	0.43" (10.9mm)
2873	2.50" (63.5mm)	2.00" (50.8mm)	0.50" (12.7mm)
2878	2.50" (63.5mm)	1.60" (40.6mm)	0.40" (10.2mm)
2874	3.00" (76.2mm)	2.375" (60.3mm)	0.64" (16.3mm)

Manual Bead Roller

This sturdy and cost effective tool makes it easy to add a professional looking bead to all types of tubing. Great for Aluminum up to 16 gauge wall thickness (0.065" or 1.65mm) and also suitable for Titanium up to 18 gauge (0.049" or 1.25mm).

Works best when secured in a vice.

Made from high quality steel and aluminum components, this assembly comes complete with everything you need straight out of the box, including a convenient carrying case.

Please Note: Always apply the bead before welding.



Minimum tube diameter to use on this bead roller is 3/4" OD.

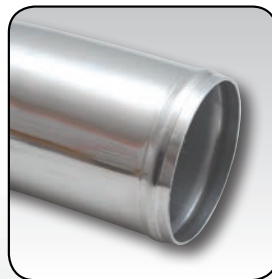

Produces a bead that is approx. 3/32" tall and 1/4" wide.



Part No. 2990



Vibrant HD Clamp System

Vibrant Performance has taken modular, flexible connectors to a whole new level with the introduction of our HD Clamp System, which is available for tube sizes ranging from 2.00" to 5.00" O.D.

- Quick Release Clamp manufactured from solid 6061 Billet Aluminum.
- Static burst pressure rating: 800 psi.
- Max. operating temperature: 400°F (205°C).
- Clamps available in Anodized Black, Anodized Blue and Mirror Polished.



HD Clamp Assemblies

Each Vibrant Performance HD Clamp assembly includes a Billet Aluminum Quick Release Clamp, a pair of Aluminum Weld Ferrules (with O-Rings), a hard anodized Aluminum Union Sleeve and a Locking Pin.

HD Clamps are backwards compatible with Vibrant Vanjen Clamp assemblies. Update your old Vanjen Clamp with a heavy duty Billet HD Clamp.

Full Assemblies

Matching Tube Size	Black Assembly Part No.	Blue Assembly Part No.	Polished Assembly Part No.
2.00" (50.8mm)	12513	12513B	12513P
2.50" (63.5mm)	12515	12515B	12515P
3.00" (76.2mm)	12516	12516B	12516P
3.50" (88.9mm)	12517	12517B	12517P
4.00" (101.6mm)	12518	12518B	12518P
5.00" (127mm)	12520	12520B	12520P

HD Clamp Only

Black Clamp Part No.	Blue Clamp Part No.	Polished Clamp Part No.
12533	12533B	12533P
12535	12535B	12535P
12536	12536B	12536P
12537	12537B	12537P
12538	12538B	12538P
12540	12540B	12540P

HD Clamp Weld Ferrules

Available in 6061 Aluminum, 304 Stainless Steel and Titanium. (sold in pairs, includes O-Rings).



Matching Tube Size	Aluminum Part No.	304 Stainless Part No.	Titanium Part No.	Matching O-Ring Part No.
2.00" (50.8mm)	12543	--	12583	12543R
2.50" (63.5mm)	12545	12555	12585	12545R
3.00" (76.2mm)	12546	12556	12586	12546R
3.50" (88.9mm)	12547	12557	12587	12547R
4.00" (101.6mm)	12548	12558	12588	12548R
5.00" (127mm)	12550	12560	--	12550R

Aluminum Union Sleeves (Hard Anodized)



Matching Tube Size	Union Sleeve Part No.
2.00" (50.8mm)	12563
2.50" (63.5mm)	12565
3.00" (76.2mm)	12566
3.50" (88.9mm)	12567
4.00" (101.6mm)	12568
5.00" (127mm)	12590

HD Clamp Replacement Pin



Part No. 12599P

Manual Boost Controller

"Turning Up The Boost" is one of the easiest and most cost effective ways to squeeze more horsepower and torque from your turbocharged vehicle.

Vibrant Performance has developed a new CNC machined Manual Boost Controller that features a unique integrated brass dial that allows you to precisely set boost, thereby reducing the risk of "overboosting" that can occur with traditional MBCs.

Features:

- 6061 Billet Aluminum construction with black anodized finish for corrosion protection.
- Includes removable fittings for easy servicing and reference line upgrades.
- Includes a low pressure check valve for use on MAF equipped applications to prevent stalling at idle.
- Large premium grade Brass adjustment knob allows for easy increase or decrease of boost pressure.
- Can be mounted nearly anywhere thanks to mounting bracket that is included.
- 4 feet of silicone vacuum hose, zip ties and installation instructions also included.



Part No. 16901

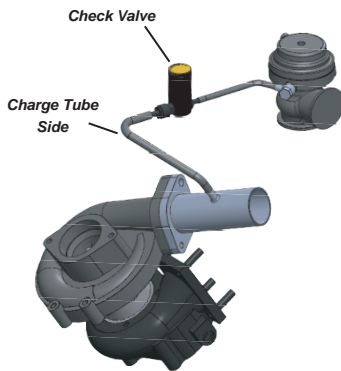

TECH TIP

If your vehicle is MAF equipped or you hear excessive noise from the Boost Controller during operation, you may opt to install the Low Pressure Check Valve that is included with your new Vibrant Performance MBC.

Install the Check Valve on the **Charge Tube Side** of the boost controller as it is a flow directional accessory.



Boost Braces

Our redesigned Aluminum Boost Brace reduces the risk of having your pressurized pipe assemblies pull apart from your clamped hose applications.

Each assembly includes a hard anodized 6061 Aluminum brace, a pair of weld dowels (available in your choice of 6061 Aluminum or 304 Stainless Steel) and 2 durable 304 Stainless Steel M8 Button Head cap screws.



Part No.	Brace Color	Dowel Material
12646	Black	Aluminum
12647	Blue	Aluminum
12648	Black	Stainless Steel
12649	Blue	Stainless Steel

TECH TIP

A Vibrant Performance Boost Brace with Stainless Steel Weld Dowels can be used alongside a Vibrant Bellows Assembly to help reduce stress on the flex joint.





Silicone Hose and Couplers

For more than a decade, Vibrant Performance Silicone Hoses and Couplers have earned the trust of industry professionals across the globe and have proven reliable even under the most extreme conditions. All Vibrant silicone hoses and couplers are manufactured to meet or exceed SAE J20 specifications and are suitable for water, coolant and air. **Not suitable for oil and fuel service.**

Our extensive offering of silicone straight hose couplings, hump hoses, transitions, elbows, CAC hoses, heaters hoses and vacuum lines makes Vibrant your one-stop source for Professional Silicone Hose Solutions.

4ply ARAMID Reinforced Straight Hose Couplers

- Available in 3", 12" and 36" lengths.
- Temperature range: -65°F to 500°F (-54°C to 260°C).
- Wall thickness: 0.18" (4.6mm).

Inlet/Outlet Hose I.D.	Black 3" Long Part No.	Black 12" Long Part No.	Black 36" Long Part No.	Max Operating Pressure
1.00" (25.4mm)	2700	27011	2701*	110 psi
1.25" (31.8mm)	2726*	27271	--	95 psi
1.50" (38.1mm)	2702	27031	2703*	80 psi
1.75" (44.5mm)	2704	27051	2705*	70 psi
2.00" (50.8mm)	2706	27071	2707*	65 psi
2.125" (54mm)	19825*	--	--	62 psi
2.25" (57.2mm)	2708	27091	2709*	60 psi
2.375" (60.3mm)	19815*	--	--	58 psi
2.50" (63.5mm)	2710	27111	2711*	55 psi
2.75" (69.9mm)	2712	27131	2713*	50 psi
3.00" (76.2mm)	2714	27151	2715*	45 psi
3.25" (82.6mm)	2720*	27211	--	42 psi
3.50" (88.9mm)	2716	27171	2717*	40 psi
4.00" (101.6mm)	2718	27191	2719*	35 psi
4.50" (114.3mm)	2722*	27231	--	N/A
5.00" (127mm)	2724	27251	--	N/A
6.00" (152.4mm)	19842* (3.50" long)	--	--	N/A



TECH TIP

Operating Pressure Ratings noted are determined based upon Ambient Temperatures. A hose's pressure capacity decreases, on average, by 20% for every 210°F (approx 100°C) increase in operating temperature.

Please note:

- Part numbers denoted with an asterisk (*) are available in Gloss Black only. All other items are also available in Gloss Blue and Red.
- For Gloss Blue, add "B" after the part number (e.g. 2700B).
- For Gloss Red, add "R" after the part number (e.g. 2700R).

4Ply ARAMID Reinforced Hump Hoses

- Hump Hose Couplings help compensate for expansion, movement and vibration and reduce the chance of your hard pipes becoming disconnected / damaged.
- Temperature range: -65°F to 500°F (-54°C to 260°C).
- Wall thickness: 0.18" (4.6mm).



Inlet/Outlet Hose I.D.	Length	Black Part No.	Blue Part No.	Red Part No.	Max Operating Pressure
1.00" (25.4mm)	3.00" (76.2mm)	2844	--	--	110 psi
1.50" (38.1mm)	3.00" (76.2mm)	2729	2729B	2729R	80 psi
1.75" (44.5mm)	3.00" (76.2mm)	2728	2728B	2728R	70 psi
2.00" (50.8mm)	3.00" (76.2mm)	2730	2730B	2730R	65 psi
2.25" (57.2mm)	3.00" (76.2mm)	2731	2731B	2731R	60 psi
2.50" (63.5mm)	3.00" (76.2mm)	2732	2732B	2732R	55 psi
2.75" (69.9mm)	3.00" (76.2mm)	2733	2733B	2733R	50 psi
3.00" (76.2mm)	3.00" (76.2mm)	2734	2734B	2734R	45 psi
3.25" (82.6mm)	3.00" (76.2mm)	2737	--	--	42 psi
3.50" (88.9mm)	3.00" (76.2mm)	2735	2735B	2735R	40 psi
4.00" (101.6mm)	3.00" (76.2mm)	2736	2736B	2736R	35 psi
4.50" (114.3mm)	3.00" (76.2mm)	2738	2738B	2738R	N/A
5.00" (127mm)	3.00" (76.2mm)	2739	2739B	2739R	N/A

4 ply Aramid Reinforced Charge Air Cooler (CAC) Hoses (with Stainless Steel Reinforcement Rings)

- Ideal for compensating for minor misalignment as well as isolating vibration.
- Temperature Range: -65°F to 500°F (-54°C to 260°C).
- Aramid reinforcement makes these hoses suitable for use on both Hot and Cold Side of a charge air cooler.

Part No.	Inlet/Outlet Hose I.D.	Overall Length	Number of Retaining Rings	Max Operating Pressure
11818	2.50" (63.5mm)	6.00" (152.4mm)	3	60 psi
11819	2.75" (69.9mm)	6.00" (152.4mm)	3	60 psi
11820	3.00" (76.2mm)	6.00" (152.4mm)	3	60 psi
11823	3.00" (76.2mm)	8.00" (203.2mm)	3	60 psi
11825	3.125" (79.4mm)	6.00" (152.4mm)	3	60 psi
11826	3.25" (82.6mm)	6.00" (152.4mm)	3	55 psi
11821	3.50" (88.9mm)	6.00" (152.4mm)	3	55 psi
11827	3.50" (88.9mm)	8.00" (203.2mm)	3	55 psi
11822	4.00" (101.6mm)	6.00" (152.4mm)	3	50 psi
11829	4.00" (101.6mm)	7.00" (177.8mm)	3	50 psi
11830	4.00" (101.6mm)	8.00" (203.2mm)	3	50 psi
11832	4.50" (114.3mm)	6.00" (152.4mm)	3	45 psi
11833	5.00" (127mm)	6.00" (152.4mm)	3	35 psi
11834	5.00" (127mm)	7.00" (177.8mm)	3	35 psi
11835	5.00" (127mm)	8.00" (203.2mm)	3	35 psi
11836	6.00" (152.4mm)	6.00" (152.4mm)	3	25 psi
11837	6.00" (152.4mm)	8.00" (203.2mm)	3	25 psi



Available in Black only

4ply ARAMID Reinforced Transition Hose Couplers

- Available in 3" lengths only.
- Temperature range: -65°F to 500°F (-54°C to 260°C).
- Wall thickness: 0.18" (4.6mm).



<i>Hose Inlet I.D.</i>	<i>Hose Outlet I.D.</i>	<i>Black Part No.</i>	<i>Blue Part No.</i>	<i>Red Part No.</i>	<i>Max Operating Pressure</i>
1.00" (25.4mm)	1.25" (31.8mm)	2920	--	--	95 psi
1.00" (25.4mm)	1.50" (38.1mm)	2922	--	--	80 psi
1.25" (31.8mm)	1.50" (38.1mm)	2921	--	--	80 psi
1.25" (31.8mm)	1.75" (44.5mm)	2923	--	--	70 psi
1.50" (38.1mm)	1.75" (44.5mm)	2762	2762B	2762R	70 psi
1.50" (38.1mm)	2.00" (50.8mm)	2763	2763B	2763R	65 psi
1.75" (44.5mm)	2.00" (50.8mm)	2767	2767B	2767R	65 psi
1.75" (44.5mm)	2.50" (63.5mm)	2838	2838B	2838R	55 psi
2.00" (50.8mm)	2.25" (57.2mm)	2765	2765B	2765R	60 psi
2.00" (50.8mm)	2.50" (63.5mm)	2766	2766B	2766R	55 psi
2.00" (50.8mm)	2.75" (69.9mm)	2778	2778B	2778R	50 psi
2.00" (50.8mm)	3.00" (76.2mm)	2779	2779B	2779R	45 psi
2.25" (57.2mm)	2.50" (63.5mm)	2768	2768B	2768R	55 psi
2.25" (57.2mm)	2.75" (69.9mm)	2769	2769B	2769R	50 psi
2.25" (57.2mm)	3.00" (76.2mm)	2770	2770B	2770R	45 psi
2.50" (63.5mm)	2.75" (69.9mm)	2771	2771B	2771R	50 psi
2.50" (63.5mm)	3.00" (76.2mm)	2772	2772B	2772R	45 psi
2.50" (63.5mm)	3.25" (82.6mm)	2761	--	--	42 psi
2.50" (63.5mm)	3.50" (88.9mm)	2764	2764B	2764R	40 psi
2.50" (63.5mm)	4.00" (101.6mm)	2928	--	--	35 psi
2.75" (69.9mm)	3.00" (76.2mm)	2773	2773B	2773R	45 psi
2.75" (69.9mm)	3.25" (82.6mm)	2834	--	--	42 psi
3.00" (76.2mm)	3.25" (82.6mm)	2760	2760B	2760R	42 psi
3.00" (76.2mm)	3.50" (88.9mm)	2774	2774B	2774R	40 psi
3.00" (76.2mm)	4.00" (101.6mm)	2775	2775B	2775R	35 psi
3.25" (82.6mm)	3.50" (88.9mm)	2835	--	--	40 psi
3.25" (82.6mm)	4.00" (101.6mm)	2839	--	--	35 psi
3.50" (88.9mm)	4.00" (101.6mm)	2776	2776B	2776R	35 psi
3.50" (88.9mm)	4.50" (114.3mm)	2836	2836B	2836R	N/A
4.00" (101.6mm)	4.50" (114.3mm)	2837	--	--	N/A
4.00" (101.6mm)	5.00" (127mm)	2777	2777B	2777R	N/A
4.50" (114.3mm)	5.00" (127mm)	2929	--	--	N/A
5.00" (127mm)	6.00" (152.4mm)	2833	--	--	N/A

TECH TIP

Do you require Silicone Hoses suitable for oil service? Or maybe you need an application specific hose?

No matter your requirement, if we don't already produce it, we would be happy to develop it for you.

4ply ARAMID Reinforced Silicone Elbows

- Temperature Range: -65°F to 500°F (-54°C to 260°C).
- Wall Thickness: 0.18" (4.6mm).



45° Elbows

<i>Inlet/Outlet Hose I.D.</i>	<i>Leg Length</i>	<i>CLR</i>	<i>Black Part No.</i>	<i>Blue Part No.</i>	<i>Red Part No.</i>	<i>Max Operating Pressure</i>
1.00" (25.4mm)	8.00" (203.2mm)	1.50" (38.1mm)	2968	--	--	110 psi
1.25" (31.8mm)	8.00" (203.2mm)	1.50" (38.1mm)	2969	--	--	95 psi
1.50" (38.1mm)	5.00" (127mm)	1.50" (38.1mm)	2759	2759B	2759R	80 psi
1.75" (44.5mm)	5.00" (127mm)	1.75" (44.5mm)	2854	2854B	2854R	70 psi
2.00" (50.8mm)	5.00" (127mm)	2.00" (50.8mm)	2750	2750B	2750R	65 psi
2.25" (57.2mm)	5.00" (127mm)	2.25" (57.2mm)	2751	2751B	2751R	60 psi
2.50" (63.5mm)	5.00" (127mm)	2.50" (63.5mm)	2752	2752B	2752R	55 psi
2.75" (69.9mm)	5.00" (127mm)	2.75" (69.9mm)	2753	2753B	2753R	50 psi
3.00" (76.2mm)	4.50" (114.3mm)	3.00" (76.2mm)	2754	2754B	2754R	45 psi
3.25" (82.6mm)	4.50" (114.3mm)	3.25" (82.6mm)	2757	--	--	42 psi
3.50" (88.9mm)	4.50" (114.3mm)	3.50" (88.9mm)	2755	2755B	2755R	40 psi
4.00" (101.6mm)	4.25" (107.9mm)	4.00" (101.6mm)	2756	2756B	2756R	35 psi
4.50" (114.3mm)	4.25" (107.9mm)	4.50" (114.3mm)	2758	--	--	N/A
5.00" (127mm)	4.00" (101.6mm)	4.50" (114.3mm)	2917	--	--	N/A

90° Elbows

<i>Inlet/Outlet Hose I.D.</i>	<i>Leg Length</i>	<i>CLR</i>	<i>Black Part No.</i>	<i>Blue Part No.</i>	<i>Red Part No.</i>	<i>Max Operating Pressure</i>
1.00" (25.4mm)	8.00" (203.2mm)	2.00" (50.8mm)	2918	--	--	110 psi
1.25" (31.8mm)	8.00" (203.2mm)	2.00" (50.8mm)	2919	--	--	95 psi
1.50" (38.1mm)	4.00" (101.6mm)	1.50" (38.1mm)	2749	2749B	2749R	80 psi
1.75" (44.5mm)	4.00" (101.6mm)	1.75" (44.5mm)	2843	--	--	70 psi
2.00" (50.8mm)	4.00" (101.6mm)	2.00" (50.8mm)	2740	2740B	2740R	65 psi
2.25" (57.2mm)	4.00" (101.6mm)	2.25" (57.2mm)	2741	2741B	2741R	60 psi
2.50" (63.5mm)	4.00" (101.6mm)	2.50" (63.5mm)	2742	2742B	2742R	55 psi
2.75" (69.9mm)	4.00" (101.6mm)	2.75" (69.9mm)	2743	2743B	2743R	50 psi
3.00" (76.2mm)	4.00" (101.6mm)	3.00" (76.2mm)	2744	2744B	2744R	45 psi
3.25" (82.6mm)	3.50" (88.9mm)	3.25" (82.6mm)	2747	--	--	42 psi
3.50" (88.9mm)	3.50" (88.9mm)	3.50" (88.9mm)	2745	2745B	2745R	40 psi
4.00" (101.6mm)	3.00" (76.2mm)	4.00" (101.6mm)	2746	2746B	2746R	35 psi
4.50" (114.3mm)	3.00" (76.2mm)	4.50" (114.3mm)	2748	--	--	N/A
5.00" (127mm)	3.00" (76.2mm)	4.50" (114.3mm)	2859	--	--	N/A

90° Transition Elbows

<i>Hose Inlet I.D.</i>	<i>Hose Outlet I.D.</i>	<i>Leg Length</i>	<i>CLR</i>	<i>Black Part No.</i>	<i>Blue Part No.</i>	<i>Red Part No.</i>	<i>Max Operating Pressure</i>
2.00" (50.8mm)	2.50" (63.5mm)	4.50" (114.3mm)	2.50" (63.5mm)	2780	2780B	2780R	55 psi
2.50" (63.5mm)	2.75" (69.9mm)	3.50" (88.9mm)	2.75" (69.9mm)	2781	2781B	2781R	50 psi
2.50" (63.5mm)	3.00" (76.2mm)	3.50" (88.9mm)	3.00" (76.2mm)	2782	2782B	2782R	45 psi
2.75" (69.9mm)	3.00" (76.2mm)	3.50" (88.9mm)	3.00" (76.2mm)	2783	2783B	2783R	45 psi
3.00" (76.2mm)	4.00" (101.6mm)	4.00" (101.6mm)	4.00" (101.6mm)	2785	2785B	2785R	34 psi

Silicone Heater Hoses

Vibrant Performance Silicone Heater Hose is both durable and flexible. Available in 2 foot, 5 foot and 20 foot lengths. 1-ply Polyester reinforced. Temperature Range: -65°F to 350°F (-54°C to 176°C).

Not suitable for oil or fuel transfer.



Available in Gloss Black only.

Hose I.D.	Hose O.D.	2ft Part No.	5ft Part No.	20ft Part No.	Max Operating Pressure
0.25" (6.4mm)	0.55" (14mm)	20402	20405	2040	85 psi
0.313" (7.9mm)	0.59" (15mm)	20412	20415	2041	85 psi
0.375" (9.5mm)	0.70" (17.8mm)	20422	20425	2042	80 psi
0.50" (12.7mm)	0.80" (20.3mm)	20432	20435	2043	80 psi
0.625" (15.9mm)	0.95" (24.1mm)	20442	20445	2044	70 psi
0.75" (19.1mm)	1.05" (26.7mm)	20452	20455	2045	70 psi
0.875" (22.2mm)	1.25" (31.8mm)	20462	20465	2046	60 psi
1.00" (25.4mm)	1.34" (34mm)	20472	20475	2047	50 psi
1.25" (31.8mm)	1.50" (38.1mm)	20482	20485	2048	50 psi

Silicone Vacuum Hoses

Vibrant Performance Silicone Vacuum Hose is designed to avoid collapse under high vacuum operation and will not peel, crack or swell.

Available in Bulk Rolls or convenient Pit Packs.



Pit Packs

Each Pit Pack includes:

- 5 feet of 0.125" (3.2mm) hose
- 10 feet of 0.16" (4mm) hose
- 4 feet of 0.19" (4.8mm) hose
- 4 feet of 0.25" (6.4mm) hose
- 2 feet of 0.375" (9.5mm) hose

Part No.	Color
2104	Gloss Black
2104B	Gloss Blue
2104R	Gloss Red

Bulk Rolls

Hose I.D.	Hose O.D.	Bulk Hose Quantity	Black Part No.	Blue Part No.	Red Part No.
0.125" (3.2mm)	0.20" (5.1mm)	50.00' (15.24m)	2100	2100B	2100R
0.16" (4mm)	0.27" (6.9mm)	50.00' (15.24m)	2101	2101B	2101R
0.19" (4.8mm)	0.31" (7.9mm)	25.00' (7.62m)	2102	2102B	2102R
0.25" (6.4mm)	0.41" (10.4mm)	25.00' (7.62m)	2103	2103B	2103R
0.31" (7.9mm)	0.55" (14mm)	10.00' (3.048m)	2106	2106B	2106R
0.375" (9.5mm)	0.66" (16.8mm)	10.00' (3.048m)	2107	2107B	2107R
0.75" (19.1mm)	1.00" (25.4mm)	10.00' (3.048m)	2108	2108B	2108R

Please note: Contact us if you require Silicone Heater Hose or Vacuum Hose in bulk lengths larger than our standard stocking items or if you prefer hose colors other than our standard black, blue or red. We accept special orders with a minimum quantity of 500ft per size.

Non-Reinforced Silicone Couplers

- Ideal for air intake / low pressure applications.
- Pair of Stainless Steel worm gear clamps included with each coupler.
- Wall thickness: 0.18" (4.6mm).
- Available in Black only.



Straight Hose Couplers

- Hose length: 3.00" (76.2mm)

Part No.	Inlet/Outlet Hose I.D.
12700	3.00" (76.2mm)
12701	3.50" (88.9mm)
12702	4.00" (101.6mm)

Transition Hose Couplers

- Hose length: 3.00" (76.2mm)

Part No.	Outlet I.D.	Inlet I.D.
12710	2.25" (57.2mm)	3.00" (76.2mm)
12711	2.50" (63.5mm)	3.00" (76.2mm)
12712	3.00" (76.2mm)	3.50" (88.9mm)
12713	3.00" (76.2mm)	4.00" (101.6mm)

90° Elbows

- Leg length from tangent: 5.00" (127mm)

Part No.	Inlet/Outlet Hose I.D.	CLR
12720	3.00" (76.2mm)	3.50" (89.9mm)
12721	3.50" (88.9mm)	4.00" (101.6mm)
12722	4.00" (101.6mm)	4.50" (114.3mm)

Stainless Steel Pinch Clamps (Sold in 10 packs)

- Made from 300 series Stainless Steel.
- Provides a 360 degree seal without gaps.
- Smooth Inner band avoids hose/tube damage.



Part No.	Clamp Range
12270	0.24"-0.28" (6.1mm - 7.1mm)
12271	0.28"-0.34" (7.1mm - 8.6mm)
12272	0.31"-0.37" (7.9mm - 9.4mm)
12273	0.37"-0.47" (9.4mm - 11.9mm)
12274	0.44"-0.54" (11.2mm - 13.7mm)
12275	0.50"-0.60" (12.7mm - 15.2mm)
12276	0.57"-0.67" (14.5mm - 17mm)
12277	0.63"-0.76" (16mm - 19.3mm)
12278	0.70"-0.83" (17.8mm - 21.1mm)
12280	0.80"-0.93" (20.3mm - 23.6mm)
12281	0.89"-1.01" (22.6mm - 25.7mm)
12282	1.00"-1.13" (25.4mm - 28.7mm)

Pinch Clamp Tool

- Durable Steel construction.
- Works with all sizes of Vibrant Performance Stainless Steel Pinch Clamps.



Part No. 12299

Stainless Steel Cushioned P-Clamps (Sold in 10 packs)

- Secure your hose line with these lightweight Stainless Steel Clamps.
- Clamps are lined with Neoprene rubber.
- 15mm band width.

Part No.	Clamp I.D.	Use with AN hose size
17190	0.50" (12.7mm)	4AN
17191	0.625" (15.9mm)	6AN
17192	0.75" (19.1mm)	8AN
17193	0.875" (22.2mm)	10AN
17194	1.00" (25.4mm)	12AN
17195	1.25" (31.8mm)	16AN
17196	1.40" (35.6mm)	20AN
17197	1.625" (41.3mm)	24AN



Fuel Injector Style Mini Hose Clamps (Sold in 10 packs)

- Zinc Plated Mild Steel construction.
- Rounded edges ensure clamp grips firmly without cutting the hose.
- Ideal for securing fuel, vacuum and windshield washer lines.



Part No.	Clamp Range
12230	0.28"-0.35" (7.1mm - 8.9mm)
12231	0.31"-0.39" (7.9mm - 9.9mm)
12232	0.35"-0.43" (8.9mm - 10.9mm)
12233	0.39"-0.47" (9.9mm - 11.9mm)
12234	0.43"-0.51" (10.9mm - 13mm)
12235	0.47"-0.55" (11.9mm - 14mm)
12236	0.51"-0.59" (13mm - 15mm)
12237	0.55"-0.63" (14mm - 16mm)
12238	0.59"-0.67" (15mm - 17mm)
12239	0.63"-0.71" (16mm - 18mm)

Hose Clamps

Vibrant Performance is the source for all of your Automotive, Commercial Vehicle and Industrial hose clamp requirements.

Stainless Steel T-Bolt Clamp (Sold in Pairs)



- Provide reliable, leak proof connections for hose and tube assemblies.
- Band Width: 3/4" (19mm).
- Always use T-bolt Clamps to clamp Reinforced Silicone Couplings.
- Features 300 series Stainless Steel construction for outstanding corrosion resistance.

Part No.	Clamp Range	Use with Vibrant Hose Coupling
2787	1.25"-1.50" (31.8mm - 38.1mm)	1.00" I.D.
2788	1.49"-1.84" (37.8mm - 46.7mm)	1.25" I.D.
2789	1.75"-2.10" (44.5mm - 53.3mm)	1.50" I.D.
2790	2.00"-2.30" (50.8mm - 58.4mm)	1.75" I.D.
2791	2.27"-2.63" (57.7mm - 66.8mm)	2.00" I.D.
2792	2.53"-2.75" (64.3mm - 69.9mm)	2.25" I.D.
2793	2.75"-3.10" (69.9mm - 78.7mm)	2.50" I.D.
2794	3.01"-3.25" (76.5mm - 82.6mm)	2.75" I.D.
2795	3.28"-3.60" (83.3mm - 91.4mm)	3.00" I.D.
2803	3.50"-3.80" (88.9mm - 96.5mm)	3.25" I.D.
2796	3.76"-4.05" (95.5mm - 102.9mm)	3.50" I.D.
2798	4.20"-4.60" (106.7mm - 116.8mm)	4.00" I.D.
2797	4.75"-5.10" (120.7mm - 129.5mm)	4.50" I.D.
2799	5.30"-5.60" (134.6mm - 142.2mm)	5.00" I.D.
2804	6.28"-6.59" (159.5mm - 167.4mm)	6.00" I.D.

Stainless Steel Worm Gear Clamps (Sold in 10 packs)

- Ideal for light to medium duty fastening applications (e.g. air intakes and vacuum hoses).
- Not recommended for high pressure applications.
- 300 series Stainless Steel construction for outstanding corrosion resistance.



Part No.	Clamp Range	Band Width
12150	0.25"-0.63" (6.4mm - 16mm)	0.312" (7.9mm)
12151	0.44"-0.90" (11.2mm - 22.9mm)	0.50" (12.7mm)
12152	0.75"-1.50" (19.1mm - 38.1mm)	0.50" (12.7mm)
12153	1.30"-2.16" (33mm - 54.9mm)	0.50" (12.7mm)
12154	2.04"-3.00" (51.8mm - 76.2mm)	0.50" (12.7mm)
12155	2.79"-3.74" (70.9mm - 95mm)	0.50" (12.7mm)
12156	3.54"-4.49" (89.9mm - 114mm)	0.50" (12.7mm)
12157	4.05"-5.00" (102.9mm - 127mm)	0.50" (12.7mm)
12158	4.56"-5.51" (115.8mm - 140mm)	0.50" (12.7mm)

TECH TIP

If you intend to loosen and re-tighten your T-Bolt Clamps regularly, applying anti-seize lubricant to the threads will improve service life.

Spring Loaded T-Bolt Clamps (Sold in Pairs)

Vibrant's new range of spring loaded T-Bolt Clamps are designed to compensate for fluctuations in all types of hoses, resulting from thermal and/or pressure changes that can cause a hose to expand or contract. The spring allows the clamps to automatically adjust to provide even tension.

- 300 series Stainless Steel band and Floating Bridge.
- Zinc Plated Steel T-bolt, lock nut and spring.
- Recommended Torque Spec: 50 in/lbs.



Part No.	Clamp Range	Use with Vibrant Hose Coupling
27820	2.25" - 2.55" (57.1mm-64.8mm)	2.00" I.D.
27822	2.46" - 2.76" (62.5mm-70.1mm)	2.25" I.D.
27825	2.69" - 2.99" (68.3m-75.9mm)	2.50" I.D.
27827	2.94" - 3.24" (74.7m-82.3mm)	2.75" I.D.
27830	3.22" - 3.52" (81.8mm-89.4mm)	3.00" I.D.
27832	3.53" - 3.83" (89.7mm-97.3mm)	3.25" I.D.
27835	3.78" - 4.08" (96mm-103.6mm)	3.50" I.D.
27840	4.28" - 4.58" (108.7mm-116.3mm)	4.00" I.D.
27845	4.78" - 5.08" (121.4mm-129mm)	4.50" I.D.
27850	5.28" - 5.58" (134.1mm-141.7mm)	5.00" I.D.
27860	6.25" - 6.55" (158.7mm-166.4mm)	6.00" I.D.



CLASSIC High Performance Air Filters

Vibrant Performance Classic Filters features a 4-ply cotton gauze filter element that allows for significantly more airflow while also providing excellent filtration of airborne particulate. Each filter is pre-oiled and is washable and reusable.

It is recommended that the filter element is cleaned every 10,000-15,000 miles (16,000 to 24,000 kilometers).

Part No.	Inlet I.D.	Filter Cap O.D.	Filter Base O.D.	Overall Height
10920	2.25" (57.2mm)	5.00" (127mm)	5.50" (139.7mm)	5.75" (146.1mm)
10921	2.50" (63.5mm)	5.00" (127mm)	6.00" (152.4mm)	6.50" (165.1mm)
10922	2.75" (69.9mm)	5.00" (127mm)	6.00" (152.4mm)	6.50" (165.1mm)
10923	3.00" (76.2mm)	5.00" (127mm)	6.00" (152.4mm)	6.50" (165.1mm)
10930	3.00" (76.2mm)	5.00" (127mm)	5.50" (139.7mm)	4.375" (111.1mm)
10924	3.50" (88.9mm)	5.00" (127mm)	5.75" (146.1mm)	6.50" (165.1mm)
10925	4.00" (101.6mm)	5.00" (127mm)	5.75" (146.1mm)	6.25" (158.8mm)
10931	4.00" (101.6mm)	5.00" (127mm)	5.50" (139.7mm)	4.375" (111.1mm)
10926	4.50" (114.3mm)	5.00" (127mm)	5.25" (133.4mm)	5.75" (146.1mm)
10932	5.00" (127mm)	5.00" (127mm)	6.00" (152.4mm)	4.375" (111.1mm)
10960	6.00" (152.4mm)	5.00" (127mm)	7.50" (190.5mm)	5.375" (136.5mm)
10961	7.00" (177.8mm)	5.00" (127mm)	8.50" (215.9mm)	8.50" (215.9mm)



Available with Black filter cap only



TECH TIP

Our Classic Series Air Filters feature an inverted cone end cap that permits more efficient airflow.

OPEN FUNNEL High Performance Air Filters

Vibrant Performance Open Funnel Filters feature an inverted cap design which increases the filter surface area for improved air flow and excellent filtration of airborne particulate.

Part No.	Inlet I.D.	Filter Cap O.D.	Filter Base O.D.	Overall Height
1921C	2.50" (63.5mm)	4.75" (120.7mm)	5.75" (146.1mm)	6.25" (158.8mm)
1923C	2.75" (69.9mm)	4.75" (120.7mm)	5.75" (146.1mm)	6.25" (158.8mm)
2160C	3.00" (76.2mm)	4.75" (120.7mm)	6.00" (152.4mm)	6.25" (158.8mm)
2161C	4.50" (114.3mm)	4.75" (120.7mm)	5.75" (146.1mm)	6.375" (161.9mm)

Please Note: OPEN FUNNEL Air Filters are not intended for use on forced induction applications.

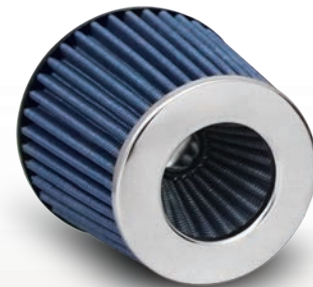

Available with Chrome filter cap only

Aluminum Bellmouth Velocity Stacks

Vibrant Performance Bellmouth-style Velocity Stacks allow for less turbulent air to enter your intake, resulting in airflow improvements and, ultimately, torque and horsepower gains.

Spun from 1/8" (3mm) thick 6061 Aluminum alloy.

Part No.	Inlet I.D.	Bellmouth O.D.	Compatible Air Filter
10950	2.50" (63.5mm)	6.00" (152.4mm)	10960
10951	3.00" (76.2mm)	6.00" (152.4mm)	10960
10952	3.50" (88.9mm)	6.00" (152.4mm)	10960
10953	4.00" (101.6mm)	7.00" (177.8mm)	10961
10954	5.00" (127mm)	8.75" (222.3mm)	--



Crankcase Breather Filters – Clamp On Style

Part No.	Inlet I.D.	Filter O.D.	Overall Height	Filter Cap Color
2165	0.375" (9.5mm)	2.1875" (55.6mm)	3.125" (79.4mm)	Chrome
2167	0.50" (12.7mm)	2.1875" (55.6mm)	3.125" (79.4mm)	Chrome
2139	0.625" (15.9mm)	1.375" (34.9mm)	2.00" (50.8mm)	Black
2166	0.625" (15.9mm)	2.1875" (55.6mm)	3.125" (79.4mm)	Chrome
2164	0.75" (19.1mm)	2.1875" (55.6mm)	3.125" (79.4mm)	Chrome
2168	1.00" (25.4mm)	2.1875" (55.6mm)	3.125" (79.4mm)	Chrome
2186	1.25" (31.8mm)	2.17" (55.1mm)	3.25" (82.6mm)	Chrome
2188	1.50" (38.1mm)	3.00" (76.2mm)	3.25" (82.6mm)	Chrome



Aluminum Mass Air Flow Sensor Adapters

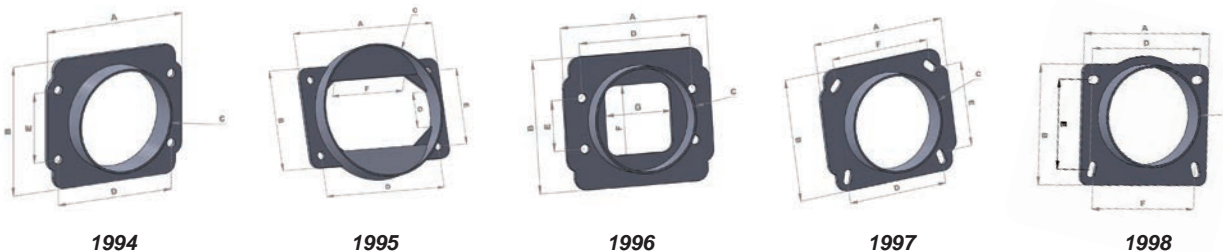

Dimensions	Part No. 1994	Part No. 1995	Part No. 1996	Part No. 1997	Part No. 1998
A	4.33" (110.2mm)	5.25" (133.3mm)	4.33" (110.2mm)	4.33" (110.2mm)	4.00" (101.6mm)
B	3.65" (92.8mm)	3.32" (84.4mm)	3.73" (94.7mm)	3.73" (94.7mm)	3.69" (93.7mm)
C	3.73" (94.7mm)	4.50" (114.3mm)	3.00" (76.2mm)	3.00" (76.2mm)	3.00" (76.2mm)
D	2.00" (50.8mm)	4.43" (112.7mm)	3.27" (83.1mm)	3.41" (86.7mm)	3.31" (84.1mm)
E	3.00" (76.2mm)	2.51" (63.9mm)	1.41" (35.9mm)	2.80" (71.3mm)	2.63" (66.8mm)
F	N/A	2.65" (67.4mm)	1.95" (49.6mm)	3.20" (81.4mm)	3.26" (82.9mm)
G	N/A	1.20" (30.6mm)	1.96" (49.8mm)	N/A	N/A

Compatible Vibrant Air Filter	Part No 10923, 10930 or 2160C	Part No 10926 or 2161C	Part No 10923, 10930 or 2160C	Part No 10923, 10930 or 2160C	Part No 10923, 10930 or 2160C



exhaust

From day one, Vibrant Performance has always been known as Performance Exhaust Specialists.

Over the years, our product offering has evolved but our commitment to the design and production of top quality performance exhaust solutions has been unwavering.

Today, we boast an enormous collection of professional exhaust fabrication components and we have earned the trust of many of the top fabricators in the industry, as well as earning fans around the globe, across a variety of industries.

Whether you need Stainless Steel Bends and Straight Tubing, Flexible Couplings, Merge Collectors, Catalytic Converters, Mufflers and Resonators or just a simple flange or gasket, we've got it, and, like everything else we do, we take pride in offering an unbeatable combination of quality and outstanding value.



Stainless and Mild Steel Tubing

Our comprehensive line of high quality 304 Stainless is consistent both dimensionally and in material composition, and requires minimal preparation for welding.

Round tubing is available in a variety of mandrel bend angles and straight lengths, in sizes ranging from 1.00" (25.4mm) to 5.00" (127mm). Oval Stainless Steel tubing is also available, in both 45° and 90° mandrel bends and straight lengths.

304 Stainless Steel U-J Mandrel Bends

Part No.	Tube O.D.	CLR	Leg length A	Leg length B	Leg length C
2601	1.50" (38.1mm)	3.00" (76.2mm)	4.00" (101.6mm)	7.00" (177.8mm)	10.00" (254mm)
2602	1.625" (41.3mm)	2.25" (57.2mm)	4.50" (114.3mm)	8.00" (203.2mm)	10.00" (254mm)
26020	1.625" (41.3mm)	2.50" (63.5mm)	4.50" (114.3mm)	8.00" (203.2mm)	9.00" (228.6mm)
2603	1.75" (44.5mm)	2.75" (69.9mm)	4.50" (114.3mm)	8.00" (203.2mm)	8.00" (203.2mm)
2604	1.875" (47.6mm)	3.00" (76.2mm)	6.00" (152.4mm)	7.00" (177.8mm)	13.00" (330.2mm)
2605	2.00" (50.8mm)	4.00" (101.6mm)	4.50" (114.3mm)	6.50" (165.1mm)	7.00" (177.8mm)
2607	2.25" (57.2mm)	3.50" (88.9mm)	4.50" (114.3mm)	7.50" (190.5mm)	8.00" (203.2mm)
2609	2.50" (63.5mm)	3.50" (88.9mm)	5.50" (139.7mm)	7.00" (177.8mm)	7.00" (177.8mm)
2615	2.75" (69.9mm)	4.125" (104.8mm)	5.50" (139.7mm)	7.00" (177.8mm)	11.00" (279.4mm)
2611	3.00" (76.2mm)	5.00" (127mm)	9.00" (228.6mm)	9.50" (241.3mm)	10.50" (266.7mm)
2612	3.50" (88.9mm)	5.50" (139.7mm)	7.00" (177.8mm)	9.00" (228.6mm)	9.00" (228.6mm)
2613	4.00" (101.6mm)	6.00" (152.4mm)	7.50" (190.5mm)	8.50" (215.9mm)	10.00" (254mm)

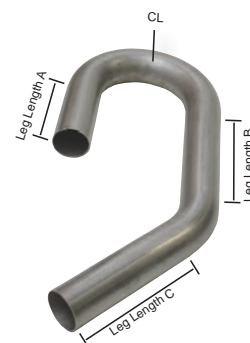

Our popular U-J Mandrel Bends are a great value, providing a 180° bend, 45° bend and a straight leg in one unit.

Aluminized Mild Steel U-J Mandrel Bends

Part No.	Tube O.D.	CLR	Leg Length A	Leg Length B	Leg Length C
12601	1.50" (38.1mm)	3.00" (76.2mm)	5.00" (127mm)	8.00" (203.2mm)	8.00" (203.2mm)
12603	1.75" (44.5mm)	3.50" (88.9mm)	5.00" (127mm)	7.00" (177.8mm)	7.00" (177.8mm)
12605	2.00" (50.8mm)	4.00" (101.6mm)	4.00" (101.6mm)	9.00" (228.6mm)	12.00" (304.8mm)
12607	2.25" (57.2mm)	3.50" (88.9mm)	4.00" (101.6mm)	8.00" (203.2mm)	12.00" (304.8mm)
12609	2.50" (63.5mm)	4.25" (108mm)	5.00" (127mm)	8.00" (203.2mm)	12.00" (304.8mm)
12611	3.00" (76.2mm)	5.00" (127mm)	8.00" (203.2mm)	10.00" (254mm)	23.00" (584.2mm)
12612	3.50" (88.9mm)	5.00" (127mm)	7.00" (177.8mm)	13.00" (330.2mm)	21.00" (533.4mm)

304 Stainless Steel 180° Mandrel Bends

Part No.	Tube O.D.	CLR	Leg length
26120	1.00" (25.4mm)	2.00" (50.8mm)	4.00" (101.6mm)
2617	1.25" (31.8mm)	2.00" (50.8mm)	4.00" (101.6mm)
2618	1.25" (31.8mm)	2.75" (69.9mm)	4.00" (101.6mm)
2619	1.375" (34.9mm)	2.375" (60.3mm)	4.00" (101.6mm)
2620	1.50" (38.1mm)	1.50" (38.1mm)	4.00" (101.6mm)
2694	1.50" (38.1mm)	2.375" (60.3mm)	4.00" (101.6mm)
2621	1.625" (41.3mm)	1.625" (41.3mm)	4.00" (101.6mm)
26950	1.625" (41.3mm)	2.625" (66.7mm)	4.00" (101.6mm)
2622	1.75" (44.5mm)	1.75" (44.5mm)	5.00" (127mm)
2699	1.75" (44.5mm)	2.50" (63.5mm)	6.00" (152.4mm)
2696	1.75" (44.5mm)	2.625" (66.7mm)	4.00" (101.6mm)
2623	1.875" (47.6mm)	2.00" (50.8mm)	6.00" (152.4mm)
2697	1.875" (47.6mm)	3.00" (76.2mm)	5.00" (127mm)
2624	2.00" (50.8mm)	2.00" (50.8mm)	6.00" (152.4mm)
2698	2.00" (50.8mm)	2.50" (63.5mm)	5.00" (127mm)
26230	2.00" (50.8mm)	3.00" (76.2mm)	5.00" (127mm)
26240	2.00" (50.8mm)	4.00" (101.6mm)	5.00" (127mm)
2625	2.125" (54mm)	3.125" (79.4mm)	5.00" (127mm)
2626	2.25" (57.2mm)	3.375" (85.7mm)	5.00" (127mm)
2627	2.375" (60.3mm)	3.50" (88.9mm)	6.00" (152.4mm)
2684	2.50" (63.5mm)	2.50" (63.5mm)	6.00" x 4.00" (152.4mm x 101.6mm)
2628	2.50" (63.5mm)	3.50" (88.9mm)	6.00" (152.4mm)
2629	2.75" (69.9mm)	4.125" (104.8mm)	6.00" (152.4mm)
2656	3.00" (76.2mm)	5.00" (127mm)	6.00" (152.4mm)
2657	3.50" (88.9mm)	5.50" (139.7mm)	6.00" (152.4mm)
2658	4.00" (101.6mm)	6.00" (152.4mm)	8.00" (203.2mm)
2659	5.00" (127mm)	7.50" (190.5mm)	12.00" (304.8mm)

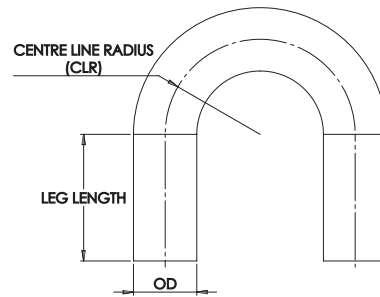
**TECH TIP:**

Customers often ask us what type of filler rod should be used when welding all the different products we offer. The following is a quick reference guide for the most commonly asked questions:

For Welding 304 S.S. to 304 S.S. use 308 filler rod
 For Welding 304 S.S. to 321 S.S. also use 308 filler rod
 For Welding 304 S.S. to Mild Steel, use 309L filler rod

For welding 6061 Aluminum, we suggest either 5356 or 4043 filler rod. 5356 is stronger, more ductile and most suitable if you intend to anodize the aluminum after welding. 4043 is more crack resistant, especially if you intend to heat treat the aluminum and it will perform better if the aluminum product you are welding is exposed to elevated temperatures (150°F / 65°C and up).

Please refer to Page 49 of this catalog to view the full offering of Vibrant Performance Stainless Steel TIG Weld Wires.



304 Stainless Steel 120° Mandrel Bends

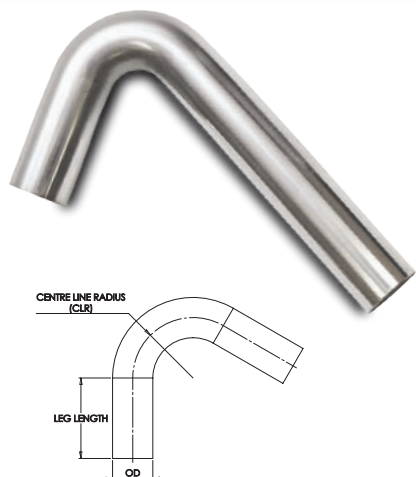

Part No.	Tube O.D.	CLR	Leg length A	Leg length B
13000	1.25" (31.8mm)	2.75" (69.9mm)	4.00" (101.6mm)	12.00" (304.8mm)
13002	1.50" (38.1mm)	1.50" (38.1mm)	4.00" (101.6mm)	12.00" (304.8mm)
13004	1.75" (44.5mm)	1.75" (44.5mm)	6.00" (152.4mm)	12.00" (304.8mm)
13005	1.875" (47.6mm)	2.00" (50.8mm)	4.00" (101.6mm)	12.00" (304.8mm)
13006	2.00" (50.8mm)	2.00" (50.8mm)	4.00" (101.6mm)	12.00" (304.8mm)
13008	2.25" (57.2mm)	3.375" (85.7mm)	4.00" (101.6mm)	12.00" (304.8mm)
13009	2.375" (60.3mm)	3.50" (88.9mm)	5.00" (127mm)	12.00" (304.8mm)
13026	2.50" (63.5mm)	2.50" (63.5mm)	4.00" (101.6mm)	12.00" (304.8mm)
13010	2.50" (63.5mm)	3.50" (88.9mm)	5.00" (127mm)	12.00" (304.8mm)
13012	3.00" (76.2mm)	5.00" (127mm)	5.00" (127mm)	12.00" (304.8mm)

304 Stainless Steel 90° Mandrel Bends

Part No.	Tube O.D.	CLR	Leg length A	Leg length B
13028	1.00" (25.4mm)	2.00" (50.8mm)	4.00" (101.6mm)	12.00" (304.8mm)
13029	1.25" (31.8mm)	2.00" (50.8mm)	4.00" (101.6mm)	12.00" (304.8mm)
13030	1.25" (31.8mm)	2.75" (69.9mm)	4.00" (101.6mm)	12.00" (304.8mm)
13031	1.375" (34.9mm)	2.375" (60.3mm)	4.00" (101.6mm)	12.00" (304.8mm)
13032	1.50" (38.1mm)	1.50" (38.1mm)	4.00" (101.6mm)	12.00" (304.8mm)
13046	1.50" (38.1mm)	2.375" (60.3mm)	4.00" (101.6mm)	12.00" (304.8mm)
13033	1.625" (41.3mm)	1.625" (41.3mm)	4.00" (101.6mm)	12.00" (304.8mm)
13047	1.625" (41.3mm)	2.50" (63.5mm)	5.00" (127mm)	12.00" (304.8mm)
13034	1.75" (44.5mm)	1.75" (44.5mm)	5.00" (127mm)	12.00" (304.8mm)
13048	1.75" (44.5mm)	2.625" (66.7mm)	5.00" (127mm)	12.00" (304.8mm)
13035	1.875" (47.6mm)	2.00" (50.8mm)	4.00" (101.6mm)	12.00" (304.8mm)
13049	1.875" (47.6mm)	3.00" (76.2mm)	5.00" (127mm)	12.00" (304.8mm)
13036	2.00" (50.8mm)	2.00" (50.8mm)	4.00" (101.6mm)	12.00" (304.8mm)
13050	2.00" (50.8mm)	2.50" (63.5mm)	4.00" (101.6mm)	12.00" (304.8mm)
13055	2.00" (50.8mm)	3.00" (76.2mm)	4.00" (101.6mm)	12.00" (304.8mm)
13037	2.125" (54mm)	3.125" (79.4mm)	4.00" (101.6mm)	12.00" (304.8mm)
13038	2.25" (57.2mm)	3.375" (85.7mm)	4.00" (101.6mm)	12.00" (304.8mm)
13039	2.375" (60.3mm)	3.50" (88.9mm)	7.00" (177.8mm)	11.00" (279.4mm)
13051	2.50" (63.5mm)	2.50" (63.5mm)	4.00" (101.6mm)	12.00" (304.8mm)
13040	2.50" (63.5mm)	3.50" (88.9mm)	5.00" (127mm)	11.00" (279.4mm)
13052	2.75" (69.9mm)	2.75" (69.9mm)	4.00" (101.6mm)	12.00" (304.8mm)
13041	2.75" (69.9mm)	4.125" (104.8mm)	5.00" (127mm)	12.00" (304.8mm)
13053	3.00" (76.2mm)	3.00" (76.2mm)	7.00" (177.8mm)	12.00" (304.8mm)
13042	3.00" (76.2mm)	5.00" (127mm)	6.00" (152.4mm)	12.00" (304.8mm)
13058	3.50" (88.9mm)	4.18" (106.2mm)	6.00" (152.4mm)	8.00" (203.2mm)
13043	3.50" (88.9mm)	5.50" (139.7mm)	8.00" (203.2mm)	8.00" (203.2mm)
13044	4.00" (101.6mm)	6.00" (152.4mm)	6.00" (152.4mm)	6.00" (152.4mm)
13045	5.00" (127mm)	7.50" (190.5mm)	7.50" (190.5mm)	6.00" (152.4mm)

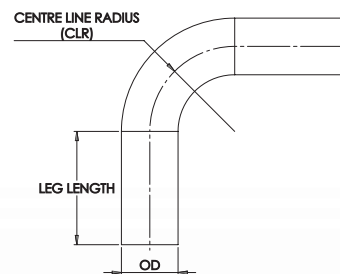

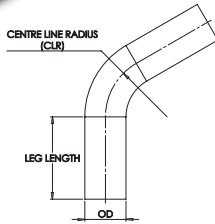

304 Stainless Steel 60° Mandrel Bends

Part No.	Tube O.D.	CLR	Leg length
13062	1.50" (38.1mm)	1.50" (38.1mm)	6.00" (152.4mm)
13064	1.75" (44.5mm)	1.75" (44.5mm)	6.00" (152.4mm)
13066	2.00" (50.8mm)	2.00" (50.8mm)	6.00" (152.4mm)
13068	2.25" (57.2mm)	3.375" (85.7mm)	6.00" (152.4mm)
13070	2.50" (63.5mm)	3.50" (88.9mm)	6.00" (152.4mm)
13071	2.75" (69.9mm)	4.125" (104.8mm)	6.00" (152.4mm)
13072	3.00" (76.2mm)	5.00" (127mm)	6.00" (152.4mm)
13073	3.50" (88.9mm)	5.50" (139.7mm)	6.00" (152.4mm)
13074	4.00" (101.6mm)	6.00" (152.4mm)	6.00" (152.4mm)

304 Stainless Steel 45° Mandrel Bends

Part No.	Tube O.D.	CLR	Leg length
13088	1.00" (25.4mm)	2.00" (50.8mm)	5.00" (127mm)
13089	1.25" (31.8mm)	2.00" (50.8mm)	5.00" (127mm)
13091	1.375" (34.9mm)	2.375" (60.3mm)	5.00" (127mm)
13092	1.50" (38.1mm)	1.50" (38.1mm)	6.00" (152.4mm)
13106	1.50" (38.1mm)	2.375" (60.3mm)	6.00" (152.4mm)
13093	1.625" (41.3mm)	2.50" (63.5mm)	6.00" (152.4mm)
13094	1.75" (44.5mm)	1.75" (44.5mm)	6.00" (152.4mm)
13108	1.75" (44.5mm)	2.625" (66.7mm)	6.00" (152.4mm)
13095	1.875" (47.6mm)	2.00" (50.8mm)	6.00" (152.4mm)
13109	1.875" (47.6mm)	3.00" (76.2mm)	6.00" (152.4mm)
13096	2.00" (50.8mm)	2.00" (50.8mm)	6.00" (152.4mm)
13110	2.00" (50.8mm)	3.00" (76.2mm)	6.00" (152.4mm)
13097	2.125" (54.0mm)	3.125" (79.4mm)	6.00" (152.4mm)
13098	2.25" (57.2mm)	3.375" (85.7mm)	6.00" (152.4mm)
13100	2.50" (63.5mm)	3.50" (88.9mm)	6.00" (152.4mm)
13101	2.75" (69.9mm)	4.125" (104.8mm)	6.00" (152.4mm)
13102	3.00" (76.2mm)	5.00" (127mm)	6.00" (152.4mm)
13103	3.50" (88.9mm)	5.50" (139.7mm)	6.00" (152.4mm)
13104	4.00" (101.6mm)	6.00" (152.4mm)	6.00" (152.4mm)
13105	5.00" (127mm)	7.50" (190.5mm)	8.00" (203.2mm)

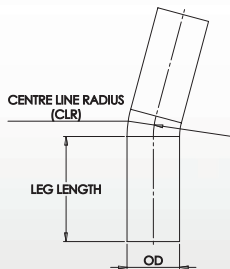
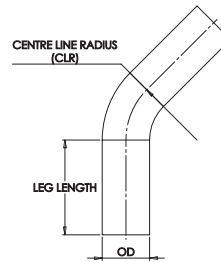

304 Stainless Steel 15° Mandrel Bends

Part No.	Tube O.D.	CLR	Leg length
13120	1.00" (25.4mm)	2.00" (50.8mm)	4.00" (101.6mm)
13121	1.25" (31.8mm)	2.00" (50.8mm)	4.00" (101.6mm)
13122	1.50" (38.1mm)	1.50" (38.1mm)	4.00" (101.6mm)
13123	1.625" (41.3mm)	2.50" (63.5mm)	4.00" (101.6mm)
13124	1.75" (44.5mm)	1.75" (44.5mm)	4.00" (101.6mm)
13125	1.875" (47.6mm)	2.00" (50.8mm)	4.00" (101.6mm)
13126	2.00" (50.8mm)	2.00" (50.8mm)	4.00" (101.6mm)
13128	2.25" (57.2mm)	3.375" (85.7mm)	4.00" (101.6mm)
13130	2.50" (63.5mm)	3.50" (88.9mm)	5.00" (127mm)
13132	3.00" (76.2mm)	5.00" (127mm)	5.00" (127mm)
13133	3.50" (88.9mm)	5.50" (139.7mm)	5.00" (127mm)
13134	4.00" (101.6mm)	6.00" (152.4mm)	5.00" (127mm)

304 Stainless Steel Round Tubing

- Available in 5 foot lengths only (1.524 meters).
- 16 gauge tube thickness (0.065").



Part No.	Tube O.D.
2597	1.00" (25.4mm)
2634	1.25" (31.8mm)
2635	1.375" (34.9mm)
2636	1.50" (38.1mm)
2637	1.625" (41.3mm)
2638	1.75" (44.5mm)
2639	1.875" (47.6mm)
2645	2.00" (50.8mm)
2646	2.125" (54mm)
2640	2.25" (57.2mm)
2647	2.375" (60.3mm)
2641	2.50" (63.5mm)
2648	2.75" (69.9mm)
2642	3.00" (76.2mm)
2643	3.50" (88.9mm)
2644	4.00" (101.6mm)
2649	5.00" (127mm)

304 Stainless Steel Transitions



Part No.	Small O.D.	Large O.D.	Length
2685	1.50" (38.1mm)	2.00" (50.8mm)	2.00" (50.8mm)
2686	2.00" (50.8mm)	2.50" (63.5mm)	2.00" (50.8mm)
2630	2.50" (63.5mm)	3.00" (76.2mm)	2.00" (50.8mm)
2632	3.00" (76.2mm)	4.00" (101.6mm)	4.00" (101.6mm)

Stainless Steel Tig Weld Wire

Vibrant Performance now offers a wide array of TIG Weld Wires in several popular material grades and thicknesses. Vibrant Weld Wire offer outstanding weld properties so that you can lay down a top quality bead. Sold in cost effective 1lb. and 3lb. pre-packs so you can buy only what you need.

Call to inquire about Bulk Quantities.

Material Grade	Rod Thickness	Rod Length	1lb Box Part No.	3lb Box Part No.
Stainless - ER308L	0.035" (0.9mm)	36.00"	29131	29133
	0.045" (1.1mm)	36.00"	29141	29143
	0.062" (1.6mm)	36.00"	29161	29163
Stainless - ER309L	0.035" (0.9mm)	36.00"	29231	29233
	0.045" (1.1mm)	36.00"	29241	29243
	0.062" (1.6mm)	36.00"	29261	29263

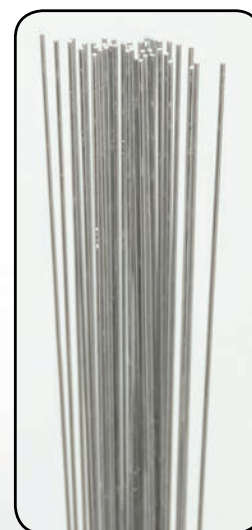

Please refer to Page 5 to view our new selection of Titanium Tig Weld Wire

304 Stainless Steel 45° and 90° Oval Mandrel Bends - Horizontal Plane



Part No.	Tube Size	CLR	Leg Length	Bend Angle
13189	2.20" x 3.45" (55.9mm x 87.6mm)	4.50" (114.3mm)	6.00" x 6.00" (152.4mm)	45°

13192	2.375" x 4.125" (60.3mm x 104.8mm)	5.25" (133.4mm)	6.00" x 6.00" (152.4mm)	45°
-------	---------------------------------------	--------------------	----------------------------	-----

Part No.	Tube Size	CLR	Leg Length	Bend Angle
13191	2.20" x 3.45" (55.9mm x 87.6mm)	4.50" (114.3mm)	6.00" x 6.00" (152.4mm)	90°

13194	2.375" x 4.125" (60.3mm x 104.8mm)	5.25" (133.4mm)	6.00" x 6.00" (152.4mm)	90°
-------	---------------------------------------	--------------------	----------------------------	-----

304 Stainless Steel 90° Oval Mandrel Bends - Vertical Plane

Part No.	Tube Size	CLR	Leg Length	Bend Angle
13200	2.20" x 3.45" (55.9mm x 87.6mm)	4.50" (114.3mm)	6.00" x 6.00" (152.4mm)	45°
13202	2.20" x 3.45" (55.9mm x 87.6mm)	4.50" (114.3mm)	6.00" x 6.00" (152.4mm)	90°



304 Stainless Steel Oval Straight Tubing

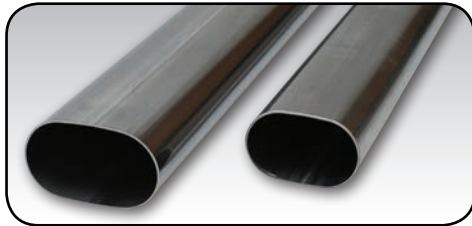

Part No.	Tube Size	Overall Length
13182	2.20" x 3.45" (55.9mm x 87.6mm)	5.00' (1.524 meters)
13183	2.375" x 4.125" (60.3mm x 104.8mm)	5.00' (1.524 meters)
13184	2.60" x 4.80" (66mm x 121.9mm)	5.00' (1.524 meters)

304 Stainless Steel Oval to Round Transitions

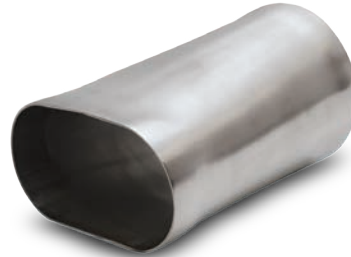

Part No.	Description	Overall Length
13170	2.20" x 3.45" oval to 3" O.D. (55.9mm x 87.6mm to 76.2mm)	6.00" (152.4mm)
13171	2.375" x 4.125" oval to 3.5" O.D. (60.3mm x 104.8mm to 88.9mm)	6.00" (152.4mm)
13172	2.60" x 4.80" oval to 4" O.D. (66mm x 121.9mm to 101.6mm)	6.00" (152.4mm)

4 Bolt Exhaust Flanges (For Oval Tubing)

Tube Size	Flange Width	Flange Height	Thickness	Single Unit Part No.	Matching Gasket Part No.
2.20" x 3.45" (55.9mm x 87.6mm)	3.90" (99.1mm)	3.25" (82.6mm)	0.375" (9.5mm)	13175S	13175G
2.375" x 4.125" (60.3mm x 104.8mm)	3.90" (99.1mm)	3.42" (86.9mm)	0.375" (9.5mm)	13176S	13176G
2.60" x 4.80" (66mm x 121.9mm)	4.82" (122.4mm)	4.46" (113.3mm)	0.375" (9.5mm)	13177S	13177G

304 Stainless Steel Schedule 10 Pipes

Vibrant Performance 304 Stainless Steel Schedule 10 Pipes are ideal for use in the construction of turbo exhaust manifolds and downpipe fabrication. The chamfered ends allow for easy butt welding. Sch. 10 Pipe = 0.12" wall thickness.

We offer Long and Tight radius 90 degree elbows, 45 degree long radius elbows, T-pipes and 12" long straight sections.

Please Note:

Pipes are normally identified by a Nominal Pipe Size (NPS) rather than Outside Diameter. Please refer to the "Actual I.D." and "Actual O.D." columns on the application list below to ensure you choose the correct pipes for your project.

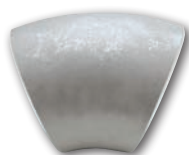

45° Elbow

45° Elbows

Part No.	Nominal Pipe Size	Actual O.D.	Actual I.D.	C
2330	1.25"	1.65" (41.9mm)	1.45" (36.8mm)	1" (25.4mm)
2331	1.5"	1.89" (48mm)	1.65" (41.9mm)	1.13" (28.7mm)

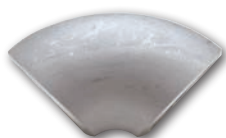
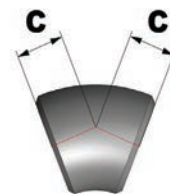

90° Tight radius elbow

90° Tight Radius Elbows

Part No.	Nominal Pipe Size	Actual O.D.	Actual I.D.	A
2340	1.25"	1.65" (41.9mm)	1.45" (36.8mm)	1.25" (31.8mm)
2341	1.5"	1.89" (48.1mm)	1.65" (41.9mm)	1.5" (38.1mm)
2345	2.5"	3" (76.2mm)	2.75" (69.9mm)	2.5" (63.5mm)
2346	3"	3.5" (88.9mm)	3.25" (82.6mm)	3" (76.2mm)

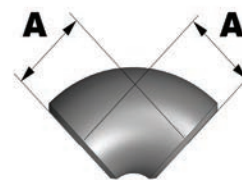

90° Long radius elbow

90° Long Radius Elbows

Part No.	Nominal Pipe Size	Actual O.D.	Actual I.D.	B
2360	1.25"	1.65" (41.9mm)	1.45" (36.8mm)	1.88" (47.8mm)
2361	1.5"	1.89" (48.1mm)	1.65" (41.9mm)	2.25" (57.2mm)

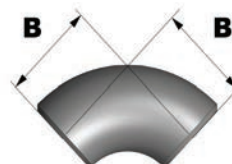

T-Pipe

Pipe Tees

Part No.	Nominal Pipe Size	Actual O.D.	Actual I.D.	D
2370	1.25"	1.65" (41.9mm)	1.45" (36.8mm)	1.88" (47.8mm)
2371	1.5"	1.89" (48.1mm)	1.65" (41.9mm)	2.25" (57.2mm)

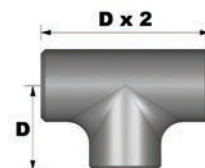

12" Straight Pipe

12" Long Straight Pipes

Part No.	Nominal Pipe Size	Actual O.D.	Actual I.D.	E
2350	1.25"	1.65" (41.9mm)	1.45" (36.8mm)	12" (304.8mm)
2351	1.5"	1.89" (48.1mm)	1.65" (41.9mm)	12" (304.8mm)



TECH TIP

Vibrant Performance now offers a large selection of Exhaust Manifold Flanges (Refer to page 61) with port dimensions that are optimized for use with Schedule 10 pipes, making it significantly easier to build your own turbo manifold.



Stainless Steel Exhaust Flanges

Vibrant Performance 304 Stainless Steel Exhaust Flanges are available in 2-bolt, 3-bolt and 4-bolt configurations, in a variety of sizes.

Matching Gaskets are available, manufactured from multi-layer Graphite material.



2 Bolt Exhaust Flanges

Flange I.D.	Width	Height	Bolt Hole Center to Center	Thickness	Box of 5 Part No.	Single Unit Part No.	Matching Gasket Part No.
2.00" (50.8mm)	4.90" (124.5mm)	3.00" (76.2mm)	3.50" (88.9mm)	0.375" (9.5mm)	1470	1470S	1455
2.25" (57.2mm)	5.25" (133.4mm)	3.50" (88.9mm)	4.00" (101.6mm)	0.375" (9.5mm)	1471	1471S	1456
2.50" (63.5mm)	5.25" (133.4mm)	3.50" (88.9mm)	4.00" (101.6mm)	0.375" (9.5mm)	1472	1472S	1457
2.75" (69.9mm)	5.25" (133.4mm)	3.66" (93mm)	3.89" (98.8mm)	0.375" (9.5mm)	1474	1474S	1465
3.00" (76.2mm)	5.05" (128.3mm)	3.70" (94mm)	4.15" (105.4mm)	0.375" (9.5mm)	1473	1473S	1458
4.00" (101.6mm)	6.00" (152.4mm)	4.40" (111.8mm)	5.00" (127mm)	0.375" (9.5mm)	1475	1475S	1459

3 Bolt Exhaust Flanges

Flange I.D.	Width	Height	Bolt Hole Circle	Thickness	Box of 5 Part No.	Single Unit Part No.	Matching Gasket Part No.
2.25" (57.2mm)	3.90" (99.1mm)	3.90" (99.1mm)	3.25" (82.6mm)	0.375" (9.5mm)	1481	1481S	1461
2.50" (63.5mm)	3.90" (99.1mm)	3.90" (99.1mm)	3.42" (86.9mm)	0.375" (9.5mm)	1482	1482S	1462
2.75" (69.9mm)	4.15" (105.4mm)	4.15" (105.4mm)	3.42" (86.9mm)	0.375" (9.5mm)	1485	1485S	1466
3.00" (76.2mm)	4.37" (111mm)	4.31" (109.5mm)	3.88" (95.6mm)	0.375" (9.5mm)	1483	1483S	1463
3.50" (88.9mm)	4.82" (122.4mm)	4.69" (119.1mm)	4.46" (113.3mm)	0.375" (9.5mm)	1484	1484S	1464

4 Bolt Exhaust Flanges (For Oval Tubing)

Oval Size	Flange Width	Flange Height	Thickness	Single Unit Part No.	Matching Gasket Part No.
2.20" x 3.45" (55.9mm x 87.6mm)	3.90" (99.1mm)	3.25" (82.6mm)	0.375" (9.5mm)	13175S	13175G
2.375" x 4.125" (60.3mm x 104.8mm)	3.90" (99.1mm)	3.42" (86.9mm)	0.375" (9.5mm)	13176S	13176G
2.60" x 4.80" (66mm x 121.9mm)	4.82" (122.4mm)	4.46" (113.3mm)	0.375" (9.5mm)	13177S	13177G

304 Stainless Steel Double Slip Joint Kits

- Three piece, leak free connection provides lowest profile exhaust connection on the market, eliminating ground clearance issues.
- Slip Fit Tolerance may tighten after heat cycle and welding.

Part No.	Tube Size
13282	1.50" (38.1mm)
13284	1.75" (44.45mm)
13286	2.00" (50.8mm)
13290	2.50" (63.5mm)
13292	3.00" (76.2mm)



V-Band Flange Assemblies

Vibrant Performance V-Band Flanges are an excellent alternative to traditional flanged or slip fit tube connections.

Our V-Band assemblies provide a gasket free seal thanks to our signature "Male-Female" flange design and superior positive retention compared to other tube coupling options.

Full Assembly includes two (2) V-Band flanges and one (1) V-Band Clamp.



Stainless Steel V-Band Flanges and Assemblies

- Flanges manufactured from 304 Stainless Steel.
- Quick Release V-band Clamps are made from 300 series Stainless Steel.

Full Assembly Part No.	Tube Size	Flange O.D.	Individual Male V-Band Flange Part No.	Individual Female V-Band Flange Part No.	V-Band Clamp Part No.
1486	For 1.50" (38.1mm) O.D. tubing	2.05" (52.1mm)	1486M	1486F	1486C
1487	For 1.75" (44.5mm) O.D. tubing	2.32" (58.9mm)	1487M	1487F	1487C
1488	For 2.00" (50.8mm) O.D. tubing	2.56" (65mm)	1488M	1488F	1488C
1489	For 2.25" (57.2mm) O.D. tubing	2.80" (71.1mm)	1489M	1489F	1489C
1497	For 2.375" (60.3mm) O.D. tubing	3.19" (81mm)	1497M	1497F	1490C
1490	For 2.50" (63.5mm) O.D. tubing	3.19" (81mm)	1490M	1490F	1490C
1496	For 2.75" (69.9mm) O.D. tubing	3.19" (81mm)	1496M	1496F	1491C
1491	For 3.00" (76.2mm) O.D. tubing	3.78" (96mm)	1491M	1491F	1491C
1492	For 3.50" (88.9mm) O.D. tubing	4.13" (104.9mm)	1492M	1492F	1492C
1493	For 4.00" (101.6mm) O.D. tubing	4.61" (117.1mm)	1493M	1493F	1493C
1494	For 5.00" (127mm) O.D. tubing	5.75" (146.1mm)	1494M	1494F	1494C

Aluminum V-Band Flanges and Assemblies

- Flanges manufactured from 6061 Aluminum. Quick Release V-band Clamps are made from 300 series Stainless Steel.
- All Vibrant Performance Aluminum Full V-Band Assemblies also comes complete with an FKM Rubber O-Ring.

Full Assembly Part No.	Tube Size	Flange O.D.	Individual Male V-Band Flange Part No.	Individual Female V-Band Flange Part No.	Replacement O-Ring Part No.	V-Band Clamp Part No.
11488	For 2.00" (50.8mm) O.D. tubing	2.56" (65mm)	11488M	11488F	11488R	1488C
11490	For 2.50" (63.5mm) O.D. tubing	3.19" (81mm)	11490M	11490F	11490R	1490C
11491	For 3.00" (76.2mm) O.D. tubing	3.78" (96mm)	11491M	11491F	11491R	1491C
11492	For 3.50" (88.9mm) O.D. tubing	4.13" (104.9mm)	11492M	11492F	11492R	1492C
11493	For 4.00" (101.6mm) O.D. tubing	4.61" (117.1mm)	11493M	11493F	11493R	1493C

* Only Aluminum Female V-Band Flanges include an FKM Rubber O-Ring

Titanium V-Band Flanges and Assemblies

- Flanges manufactured from CP5 Grade Titanium. Quick Release V-band Clamps are made from 300 series Stainless Steel.
- Please refer to pages 4 and 5 of this catalog to view our entire range of Titanium Fabrication Components.

Full Assembly Part No.	Tube Size	Flange O.D.	Individual Male V-Band Flange Part No.	Individual Female V-Band Flange Part No.	V-Band Clamp Part No.
12490	For 2.50" (63.5mm) O.D. tubing	2.56" (65mm)	12490M	12490F	1490C
12491	For 3.00" (76.2mm) O.D. tubing	3.19" (81mm)	12491M	12491F	1491C
12492	For 3.50" (88.9mm) O.D. tubing	3.78" (96mm)	12492M	12492F	1492C
12493	For 4.00" (101.6mm) O.D. tubing	4.13" (104.9mm)	12493M	12493F	1493C



Turbo Flanges & Fittings

Vibrant Performance offers a large assortment of Turbo Inlet and Discharge Flanges, Compressor Outlet Flanges, External Wastegate Flanges, Oil Feed and Oil Drain Flanges. Multi-layer metal gaskets are available for some of our flanges.

Turbine Inlet Flanges

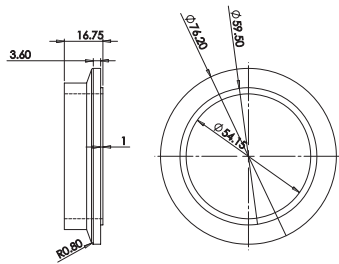

Part No. 1390

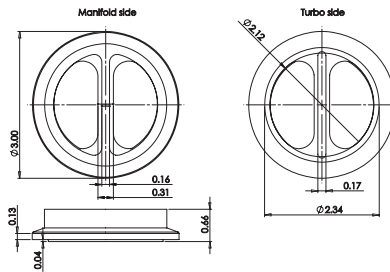

Part No. 1391

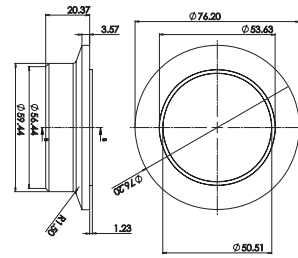

Part No. 1416

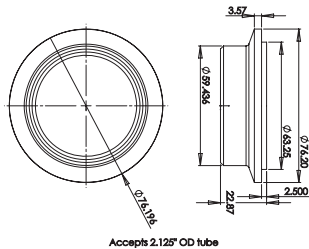

Part No. 19951

Accepts 2.125" OD tube

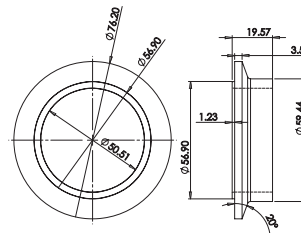

Part No. 1418

Application	304 Stainless Steel Part No.	Matching Clamp Part No.
V-Band inlet for Garrett GT/GTX30/35 and Garrett G25-550/660 Turbo models	1390	1416C
Garrett Turbine GTX2860R/2867R	19861	TBA
Garrett GT30 and GT35 models (Divided/Twin Scroll)	1391	1416C
Tial Turbines for Garrett GT/GTX 28/30/35 center cartridges	1416	1416C
Borg Warner EFR 6258/6758/7163 (I Type) and EFR 6758/7163 (F Type)	19951	1416C
Precision Turbo Engineering CAE 5 series and 6 series models	1418	1418C
V-Band inlet for Garrett GTX5533R SFI Turbine	19862	TBA



Part No. 11640A

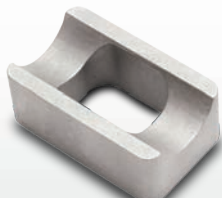

Part No. 11640B

Application	Mild Steel Part No.
T3 Log Style Manifold Inlet Flange with Wastegate provision	11640A
T3 Log Style Manifold Inlet Flange	11640B

Turbine Inlet Flanges (Continued)

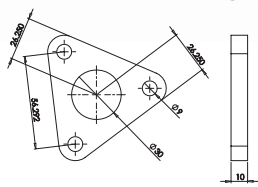

Part No. 19856

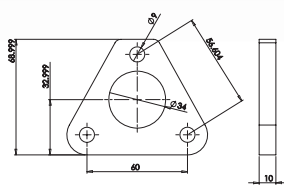

Part No. 19853

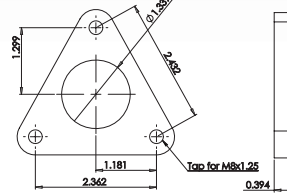

Part No. 19860

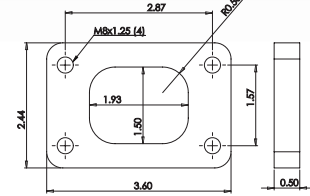

Part No. 1430

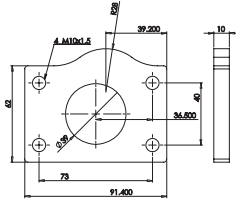

Part No. 19820

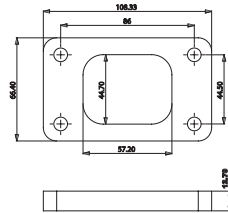

Part No. 1400

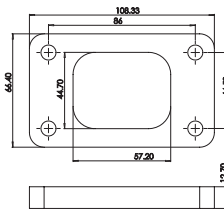

Part No. 1431

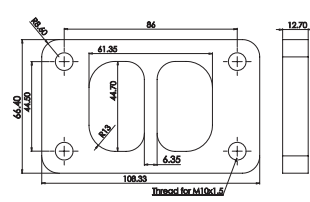

Part No. 1445

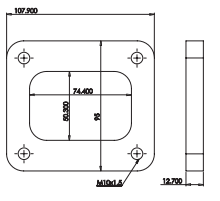

Part No. 1441

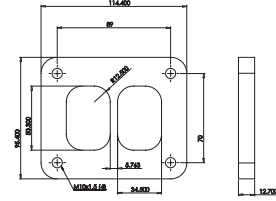

Part No. 19859

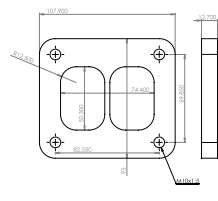

Part No. 1442

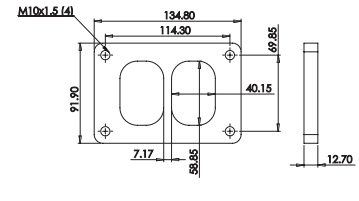

Part No. 1443

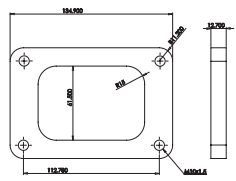

Part No. 1417

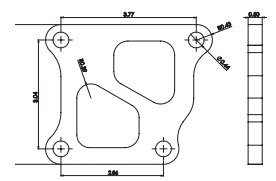

Part No. 14020

Application	304 S.S. Part No.	Mild Steel Part No.	Gasket Part No.
Garrett GT1241	19856	--	--
Garrett GT1544 (model 454082-2)	19853	--	--
Garrett GT1544 (model 454082-3)	19860	--	--
Garrett GT1548 / GT2056 / all GT22 / all GT25R / all GT28R / GT3071R, Garrett G-Series 25-550/660 and Borg Warner EFR 6758/7163 F-Type turbine	1430	14300	1430G
Garrett GT2052	19820	--	--
All Garrett T3 turbine housings and Borg Warner EFR 7064/7670 B-Type turbine	1400	14000	1400G
Larger opening T3 turbine housings found on T3/T4s and Turbonetics	1431	14310	1431G
Garrett GT3271 turbine	1445	14450	1445G
Generic T4	1441	14410	1441G
Divided T4 on Garrett GT3788 / GT4088R/GTX4088R / GT4094R / GT4202R GT4294R/ GT4508R/GTX4508R (Does Not fit GT4088R model 703457-2) Borg Warner EFR 7064/7670 D/C/G type	1442	14420	1442G
Garrett GT4088R turbine (model 703457-2)	19859	--	--
All Garrett GT/GTX47 through to GT60 T6 turbine equipped turbos	1417	14170	1417G
Garrett GT/GTX42 T6 turbine equipped turbos	1443	14430	1443G
EVO 7/8/9 and other Mitsubishi model turbines	--	14020	--
Borg Warner S series Divided T4	19863	19864	--



Turbine Outlet Flanges

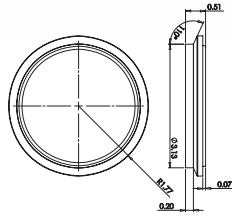

Part No. 19886

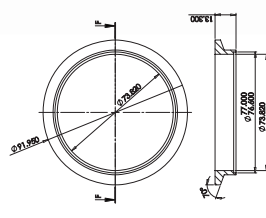

Part No. 19884

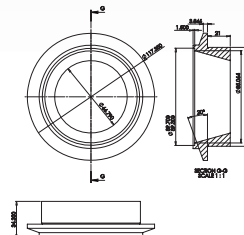

Part No. 19882

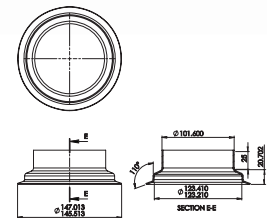

Part No. 19883

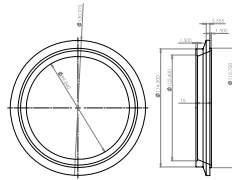

Part No. 19847

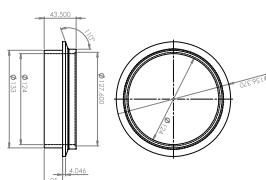

Part No. 19846

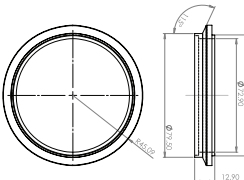

Part No. 1415

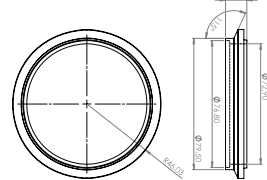

Part No. 1419

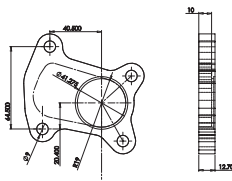

Part No. 19855

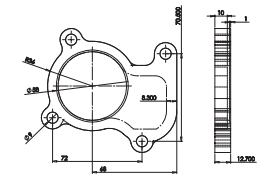

Part No. 19852

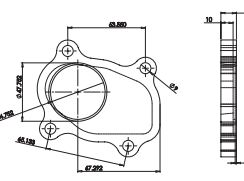

Part No. 19851

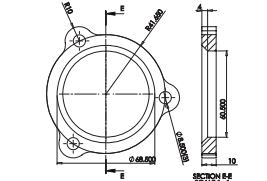

Part No. 19830

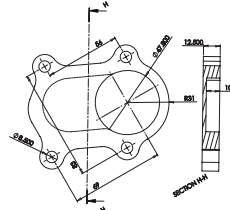

Part No. 19835

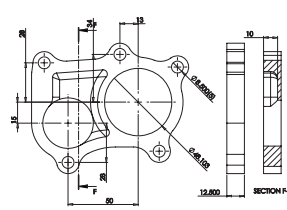

Part No. 19802

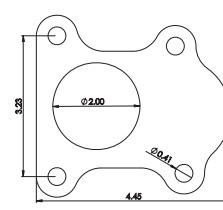

Part No. 19805

Application	304 S.S. Part No.	Matching Clamp Part No.
Garrett GTX2860R/2867R turbine	1390	TBA
Garrett GT/GTX 30/35 and Garrett G25-550/660 Turbine -- V-Band style	19886	1415C
Garrett GT/GTX 30/35/37/40 Divided and all Borg Warner EFR turbine outlets -- V-Band Style	19884	1415C
Garrett GT/GTX 42/45 turbine -- V-Band Style	19882	TBA
Garrett GT4294 (model 731376-1) and GT4202 (model 731376-2) turbines -- V-Band style	19883	TBA
Garrett GT/GTX 47 thru 55 T4 turbines (excluding GT5533R) -- V-Band style	19847	TBA
Turbine Garrett GTX553R SFI Turbine -- V-Band style	19865	TBA
Turbine Garrett GTX553R T6 Turbine -- V-Band	19866	TBA
Garrett GT60 Turbine -- V-Band	19846	TBA
Tial Turbine Housing to fit Garrett GT/GTX 28/30/35 center cartridges - V-Band Style	1415	1415C
Precision Turbo Engineering CAE 5 series and 6 series models -- V-Band Style	1419	1415C

Application	304 S.S. Part No.	Gasket Part No.
Garrett GT1241 Turbine	19855	TBA
Garrett GT1544 Turbine	19852	TBA
Garrett GT1548 Turbine	19851	TBA
Garrett GT2052 Turbine	19830	TBA
Garrett GT2056 Turbine	19835	TBA
Garrett GT2252 Turbine	19802	TBA
Garrett GT2259 Turbine	19805	TBA

Wastegate Flanges

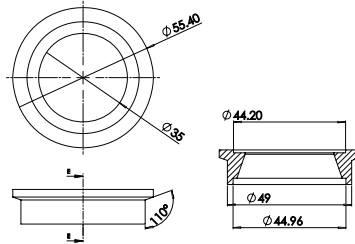

Part No. 1424

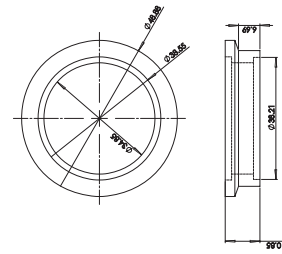

Part No. 1426

Application	304 S.S. Part No.
Wastegate Inlet Flange for Tial MV-S 38mm and Turbosmart Ultragate 40mm	1424
Wastegate Outlet Flange for Tial MV-S 38mm and Turbosmart Ultragate 40mm	1426

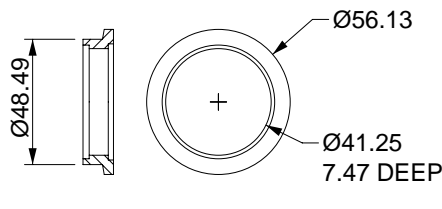

Part No. 1410A

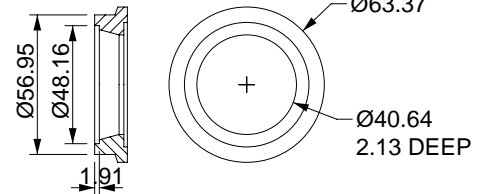

Part No. 1411A

Application	304 S.S. Part No.
Wastegate Inlet Flange for Tial MV-R 44mm	1411A
Wastegate Outlet Flange for Tial MV-R 44mm	1410A

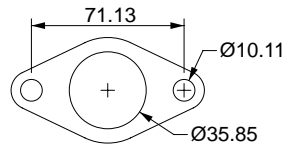

Part No. 1436

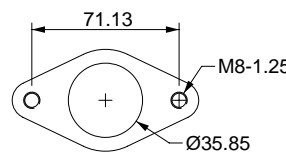

Part No. 1437

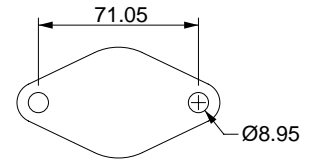

Part No. 14290

Application	304 S.S. Part No.	Mild Steel Part No.	Matching Gasket Part No.
Wastegate Inlet Flange for Tial 35-38mm (with threaded holes)	1437	14370	1436G
Wastegate Outlet Flange for Tial 35-38mm (with drilled holes)	1436	14360	1436G
Block Off Flange for Tial 35-38mm External Wastegate	--	14290	1436G

38mm to 44mm Wastegate Adapter Flange

Upgrade from 35-38mm wastegate to a Tial 44mm wastegate without cutting off your existing 2-bolt flange.

304 S.S. Part No.	Matching Gasket Part No.
1427	1436G

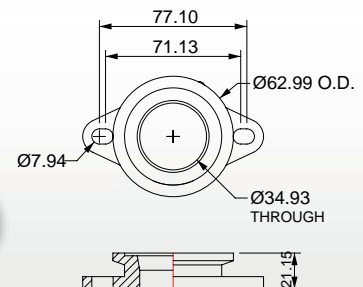
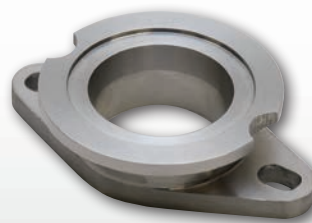

Compressor Inlet Flanges



Part No. **14904/14905**

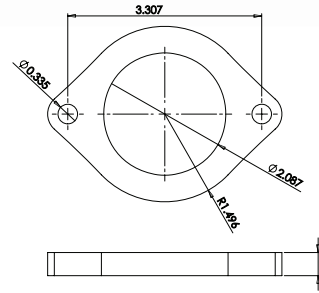

Application

Compressor **Inlet** Flange for GT2560R, GT2859R, GT2860R, GT2871R (also fits many OEM Nissan turbos, including SR20, RB25 and RB26)

304 S.S. Part No.

14905

Aluminum Part No.

14904

Compressor Outlet Flanges



Part No. **14906**

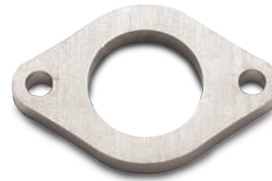
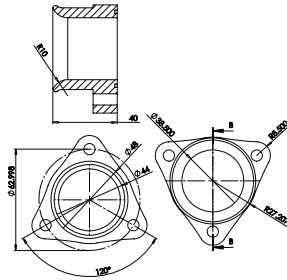

Part No. **14908/14909**

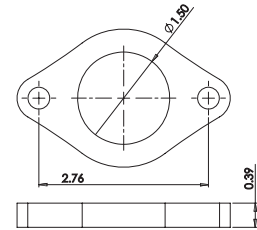

Application

Compressor **Outlet** Flange for GT2560R, GT2854R, GT2871R (also fits OEM Nissan SR20 turbo)

304 S.S. Part No.

--

Aluminum Part No.

14906

Compressor **Outlet** Flange for GT2859R and GT2860R (also fits OEM Nissan RB25 and RB26 turbo)

14909

14908



Includes O-ring

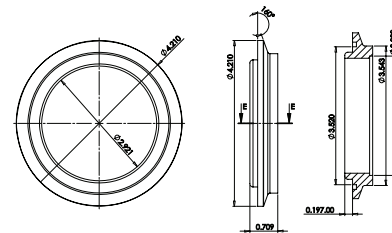

Application

V-Band Style Compressor **Outlet** Flange for GT42, GT/GTX45, GT/GTX47, GTX50 and GT/GTX55

304 S.S. Part No.

14943

6061 Aluminum Part No.

14942

V-Band Clamp Part No.

14942C



Application

V-Band Style Compressor **Outlet** Flange for Borg Warner S300

304 S.S. Part No.

14902

6061 Aluminum Part No.

14902

Blow Off Valve Flange Assemblies

Vibrant Performance makes it easy to weld Blow Off Valve Mating Flanges to your induction plumbing.

Each Blow Off Valve Flange Kit comes complete with a coped weld fitting that is also threaded so that you can simply screw on the mating flange, which is very convenient if, down the road, you decide to switch BOVs. Simply thread off the old flange and thread on the appropriate flange to match your new BOV. These assemblies are also ideal for kit builders who offer their customers the option of choosing the BOV they want to use.

The Weld Fittings are available in your choice of 6061 Aluminum or Mild Steel construction. The Thread-On Fittings are made from 6061 Billet Aluminum. Each kit also includes an O-Ring for a leak free seal.



Weld-On Flange Kit for HKS BOV

- Part No. 1451** (Aluminum Weld Fitting / Aluminum Flange)
- Part No. 1452** (Mild Steel Weld Fitting / Aluminum Flange)
- Part No. 10127H** (Aluminum Thread-On Replacement Flange)
- Part No. 10127O** (Replacement O-Ring)

Weld-On Flange Kit for Greddy BOV

- Part No. 1453** (Aluminum Weld Fitting / Aluminum Flange)
- Part No. 1454** (Mild Steel Weld Fitting / Aluminum Flange)
- Part No. 10127G** (Aluminum Thread-On Replacement Flange)
- Part No. 10127O** (Replacement O-Ring)



Weld-On Flange Kit for Tial Style BOV

- Part No. 1477** (Aluminum Weld Fitting / Aluminum Flange)
- Part No. 1478** (Mild Steel Weld Fitting / Aluminum Flange)
- Part No. 10134** (Aluminum Thread-On Replacement Flange)
- Part No. 10127O** (Replacement O-Ring)

Stainless Steel Interlock Hose

Stainless Steel Interlock Hose provides extra flexibility when fabricating a Wastegate Dump Tube in tight areas.

Part No.	Description
84027	1.50" I.D. (38.1mm) x 20.00" (508mm) long S.S. Interlock Hose



Exhaust Manifold Flanges

Vibrant Performance has developed one of the largest offerings of exhaust manifold flanges in the industry, ready when you need them.

Our 3/8" (9.5mm) thick 304 Stainless Steel flanges have had their exhaust port sizing optimized for use with standard wall round tubing.

We also offer 1/2" (12.7mm) thick Mild Steel flanges that have had their exhaust ports designed to be used with Schedule 10 or Schedule 40 weld fittings.

<i>Description</i>	<i>3/8" Thick 304 SS Part No.</i>	<i>1/2" Thick Mild Steel Part No.</i>
AUDI 2.7T motor (2 flanges / set)	14227	14627
BMW E36 / E46 motors (2 flanges / set)	14336	14636
FORD 4.6L (32 valve) DOHC motors (2 flanges / set)	14464	--
FORD 4.6L (16 valve) SOHC motors (2 flanges / set)	14462	--
FORD 260-351W motor (2 flanges / set)	14302	--
GM Ecotec motor	1460E	14630
GM LT1/L98/LB9 Small Block motor – Round Port (2 flanges / set)	14331	--
GM LT1/L98/LB9 Small Block motor – "D" Port (2 flanges / set)	14331D	--
GM LS1/LS2/LS3/LS6/L92 motor (2 flanges / set)	14332	--
HONDA / ACURA B-series motor	1460	14610
HONDA / ACURA D-series motor	1460D	14610D
HONDA F20C & F22C motor	1460F	14610F
HONDA H22 motor	1460H	14610H
HONDA / ACURA K-series motor	1460K	14610K
HONDA / ACURA K24Z7 motor (2012-2015 Civic Si)	14224	14724
HYUNDAI Theta 2.0L motor (Genesis 2.0T)	--	14634
MAZDA 4B11 motor	--	14611
MAZDA 4G63 motor	1460M	14663
NISSAN KA24 motor	1460A	14624
NISSAN RB25/RB26 motor	1460R	14625
NISSAN SR20 motor	1460S	14620N
NISSAN VK56 motor (2 flanges / set)	14256	--
NISSAN VR38DETT motor (2 flanges / set)	--	14635
PORSCHE 930/911 motor (6 flanges / set)	14930	--
PORSCHE 996/911 motor (2 flanges / set)	14296	14696
SUBARU EJ20 motor (2 flanges / set)	14220S	--
TOYOTA 2JZ GTE motor	1460J	14610J
TOYOTA 2AZ-FE motor	1460T	14633
VW / AUDI 1.8T motor	1460V	14618
VW / AUDI 2.0 FSI motor	--	14620V
VW 2.5L 5 cyl motor (available 2005 and up)	14325	14725



Part No. 1460M



Part No. 14610F



Part No. 14464



Part No. 14636



Part No. 1460J



Part No. 14462



Part No. 1460V



■ Merge Collectors

All Vibrant Performance Merge Collectors feature complete 16 gauge, 304 Stainless Steel construction, precise fabrication, back purged TIG welds at every seam.

Each Vibrant Performance collector is individually packaged, prepped and ready to weld straight out of the box.

4 into 1 Merge Collectors

Part No.	Inlet Slipover I.D.	Merge O.D.	Transition Cone O.D.	Overall Length
10302	1.75" (44.5mm)	2.50" (63.5mm)	3.00" (76.2mm)	10.63" (270mm)
10303	1.75" (44.5mm)	3.00" (76.2mm)	3.50" (88.9mm)	9.37" (238mm)
10305	1.875" (47.6mm)	2.50" (63.5mm)	3.00" (76.2mm)	11.125" (283mm)
10306	1.875" (47.6mm)	3.00" (76.2mm)	3.50" (88.9mm)	10.12" (257mm)
10307	1.875" (47.6mm)	3.50" (88.9mm)	4.00" (101.6mm)	10.00" (254mm)
10308	2.00" (50.8mm)	3.00" (76.2mm)	3.50" (88.9mm)	10.12" (257mm)
10309	2.00" (50.8mm)	3.50" (88.9mm)	4.00" (101.6mm)	9.13" (232mm)
10312	2.125" (54mm)	3.50" (88.9mm)	4.00" (101.6mm)	9.88" (251mm)
10313	2.125" (54mm)	4.00" (101.6mm)	4.50" (114.3mm)	10.87" (276mm)
10316	2.25" (57.2mm)	3.50" (88.9mm)	4.00" (101.6mm)	10.40" (264mm)
10317	2.25" (57.2mm)	4.00" (101.6mm)	4.50" (114.3mm)	10.50" (267mm)

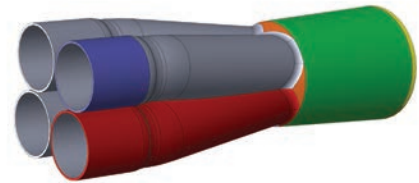

2 into 1 Merge Collectors

Part No.	Inlet Slipover I.D.	Outlet O.D.	Overall Length
10350	1.50" (38.1mm)	1.75" (44.5mm)	6.90" (175mm)
10351	1.625" (41.3mm)	2.00" (50.8mm)	7.65" (194mm)
10352	1.75" (44.5mm)	2.00" (50.8mm)	8.00" (203.2mm)
10353	1.75" (44.5mm)	2.25" (57.2mm)	8.00" (203.2mm)
10354	1.875" (47.6mm)	2.25" (57.2mm)	8.50" (215.9mm)
10355	2.00" (50.8mm)	2.50" (63.5mm)	8.13" (206mm)
10356	2.25" (57.2mm)	3.00" (76.2mm)	8.45" (214.5mm)
10357	2.50" (63.5mm)	2.50" (63.5mm)	8.50" (215.9mm)
10358	2.50" (63.5mm)	3.00" (76.2mm)	8.50" (215.9mm)
10359	2.50" (63.5mm)	3.50" (88.9mm)	8.60" (218.5mm)
10360	3.00" (76.2mm)	3.00" (76.2mm)	9.00" (228.6mm)
10361	3.00" (76.2mm)	3.50" (88.9mm)	9.00" (228.6mm)
10362	3.00" (76.2mm)	4.00" (101.6mm)	9.00" (228.6mm)

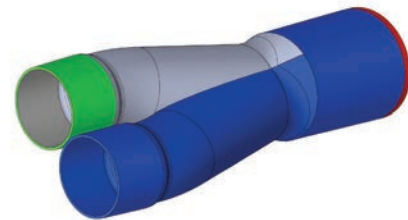

Weld on Collector Tab Set

Part No.	Description
10340	Set of S.S. collector tabs, (2 tabs, 1 Spring)



Cast 304 Stainless Steel "Y" Collector

- A durable, cost effective solution for fabricating dual exhaust systems.
- 3.5mm Thickness.

Part No.	Inlet I.D.	Outlet O.D.	Collector Width	Collector Height
11743	3.00" (76.2mm)	Dual 2.50" (63.5mm)	4.33" (110mm)	3.25" (82.5mm)



Turbo Manifold Merge Collectors

- Constructed from 304 Stainless Steel Schedule 10 pipe.
- Each component is precision 3D laser cut to create tight fitment.
- Each assembly is tack welded for ease of adjustability.
- Available in 4 into 1 and 6 into 1 configuration.



4 into 1 Collectors

Part No.	Description / Application	Pipe O.D.	Collector Height	Collector Outlet Dimensions
2450	To Fit T25/T28 Inlet Flange	1.625" (41.3mm)	3.00" (76.2mm)	2.25" x 1.75" (57.2mm x 44.5mm)
2455	To Fit T25/T28 Inlet Flange	1.875" (47.6mm)	4.50" (114.3mm)	2.25" x 1.75" (57.2mm x 44.5mm)
2451	To Fit T3 and T3/T4 Inlet Flange	1.875" (47.6mm)	3.00" (76.2mm)	2.875" x 1.875" (73mm x 47.6mm)
2454	To Fit T3 and T3/T4 Inlet Flange	1.875" (47.6mm)	4.50" (114.3mm)	2.875" x 1.875" (73mm x 47.6mm)
2465	To Fit T3 Divided Inlet Flange	1.875" (47.6mm)	4.50" (114.3mm)	2.94" x 2.25" (74.7mm x 57.2mm)
2453	To Fit T4 Inlet Flange	1.875" (47.6mm)	4.75" (120.7mm)	3.063" x 2.50" (77.8mm x 63.5mm)
2466	To Fit T4 Divided Inlet Flange	1.875" (47.6mm)	4.50" (114.3mm)	2.94" x 2.25" (74.7mm x 57.2mm)
2457	To fit Inlet Flange on GT28/30/35 with Tial Turbine Housing	1.875" (47.6mm)	4.50" (114.3mm)	Ø2.125" (54mm)

6 into 1 Collectors

Part No.	Description / Application	Pipe O.D.	Collector Height	Collector Outlet Dimensions
2456	To Fit T4 Inlet Flange	1.875" (47.6mm)	4.25" (108mm)	2.94" x 2.25" (74.7mm x 57.2mm)
2458	To Fit T4 Inlet Flange	1.875" (47.6mm)	4.25" (108mm)	2.94" x 2.25" (74.7mm x 57.2mm)



Part No. 2456

Collector Outlet



Part No. 2458

Collector Outlet



Stainless Steel Flexible Couplings

Vibrant is a world leader in the design and manufacturing of Stainless Steel Flexible Couplings. Our Flex Couplings are engineered to isolate vibration and thermal cycles generated by the engine, thereby relieving stress on a vehicle's exhaust system, as well as reducing the risk of premature failure of manifolds and downpipes while extending the service life of other components.

Electropolished Bellows Assemblies (with Directional Flow Solid Liner)

Part No.	I.D.	Length
68327	1.50" (38.1mm)	2.75" (69.9mm)
68425	1.75" (44.4mm)	2.50" (63.5mm)
68527	1.875" (47.6mm)	2.75" (69.9mm)
68632	2.02" (51.3mm)	3.25" (82.6mm)
68683	2.25" (57.2mm)	3.00" (76.2mm)
68724	2.50" (63.5mm)	4.00" (101.6mm)
68834	3.02" (76.7mm)	4.00" (101.6mm)
68935	3.50" (88.9mm)	4.00" (101.6mm)
68944	4.00" (101.6mm)	4.00" (101.6mm)



Full 304 Stainless Steel Construction

TurboFlex Couplings (with Interlock Liner)



Vibrant's Turbo Flex Coupling features an internal Stainless Steel Interlock Liner to facilitate smooth flow of high temperature exhaust gases. Recommended for all high flowing, high temperature applications (e.g. forced induction).

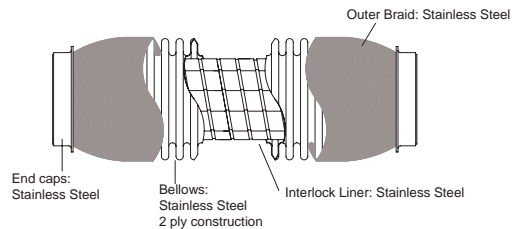

Part No.	I.D.	Length
60404	1.75" (44.5mm)	4.00" (101.6mm)
60604	2.00" (50.8mm)	4.00" (101.6mm)
60606	2.00" (50.8mm)	6.00" (152.4mm)
60704	2.25" (57.2mm)	4.00" (101.6mm)
60804	2.50" (63.5mm)	4.00" (101.6mm)
60806	2.50" (63.5mm)	6.00" (152.4mm)
60808	2.50" (63.5mm)	8.00" (203.2mm)
60810	2.50" (63.5mm)	10.00" (254mm)
61004	3.00" (76.2mm)	4.00" (101.6mm)

Part No.	I.D.	Length
61006	3.00" (76.2mm)	6.00" (152.4mm)
61008	3.00" (76.2mm)	8.00" (203.2mm)
61010	3.00" (76.2mm)	10.00" (254mm)
61108	3.50" (88.9mm)	8.00" (203.2mm)
61110	3.50" (88.9mm)	10.00" (254mm)
61208	4.00" (101.6mm)	8.00" (203.2mm)
61210	4.00" (101.6mm)	10.00" (254mm)
61408	5.00" (127mm)	8.00" (203.2mm)
61410	5.00" (127mm)	10.00" (254mm)

Standard Flex Couplings (with Internal Braid Liner)



Vibrant Flex Couplings with Inner Braid Liner provide laminar flow while retaining flexibility in the coupling itself. The Inner Braid protects the Bellows from premature failure, and is ideal for eliminating exhaust "whistle".

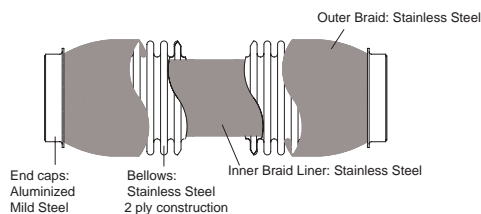

**Best Suited For Naturally Aspirated applications.
Not recommended for Forced Inductions applications.**

Part No.	I.D.	Length
62304	1.50" (38.1mm)	4.00" (101.6mm)
62306	1.50" (38.1mm)	6.00" (152.4mm)
62308	1.50" (38.1mm)	8.00" (203.2mm)
62404	1.75" (44.5mm)	4.00" (101.6mm)
62406	1.75" (44.5mm)	6.00" (152.4mm)
62408	1.75" (44.5mm)	8.00" (203.2mm)
62410	1.75" (44.5mm)	10.25" (260.4mm)
62604	2.00" (50.8mm)	4.00" (101.6mm)
62606	2.00" (50.8mm)	6.00" (152.4mm)
62608	2.00" (50.8mm)	8.00" (203.2mm)
62610	2.00" (50.8mm)	10.00" (254mm)

Part No.	I.D.	Length
62704	2.25" (57.2mm)	4.00" (101.6mm)
62706	2.25" (57.2mm)	6.00" (152.4mm)
62708	2.25" (57.2mm)	8.00" (203.2mm)
62804	2.50" (63.5mm)	4.00" (101.6mm)
62806	2.50" (63.5mm)	6.00" (152.4mm)
62808	2.50" (63.5mm)	8.00" (203.2mm)
62810	2.50" (63.5mm)	10.00" (254mm)
63004	3.00" (76.2mm)	4.00" (101.6mm)
63006	3.00" (76.2mm)	6.00" (152.4mm)
63008	3.00" (76.2mm)	8.00" (203.2mm)

Standard Flex Couplings (No Liner)



Our Standard Flex Couplings (without Inner Liner) offer a cost effective solution for isolating vibration and protecting a vehicle's exhaust components from damage.

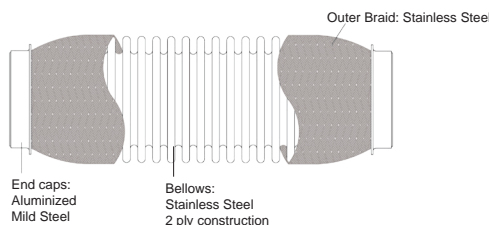

Part No.	I.D.	Length
64304	1.50" (38.1mm)	4.00" (101.6mm)
64404	1.75" (44.5mm)	4.00" (101.6mm)
64406	1.75" (44.5mm)	6.00" (152.4mm)
64408	1.75" (44.5mm)	8.00" (203.2mm)
64410	1.75" (44.5mm)	10.00" (254mm)
64604	2.00" (50.8mm)	4.00" (101.6mm)
64606	2.00" (50.8mm)	6.00" (152.4mm)
64608	2.00" (50.8mm)	8.00" (203.2mm)
64610	2.00" (50.8mm)	10.00" (254mm)

Part No.	I.D.	Length
64704	2.25" (57.2mm)	4.00" (101.6mm)
64708	2.25" (57.2mm)	8.00" (203.2mm)
64806	2.50" (63.5mm)	6.00" (152.4mm)
64808	2.50" (63.5mm)	8.00" (203.2mm)
64810	2.50" (63.5mm)	10.00" (254mm)
65006	3.00" (76.2mm)	6.00" (152.4mm)
65008	3.00" (76.2mm)	8.00" (203.2mm)
65010	3.00" (76.2mm)	10.00" (254mm)

GESi® Ultra High Output Universal OBD2 Compliant Catalytic Converters

Say goodbye to converter failures, failed emissions tests and Check Engine Lights (CEL) for your high performance vehicle.

Vibrant Performance and Global Emissions Systems Inc. (GESi) have teamed up to produce a range of OBD2 (1996 and newer) high flow Catalytic Converters that provide peace of mind and reliability under extreme conditions while providing highly effective, long term emissions control solutions.

- EPA certified for use on OBD2 vehicles in jurisdictions where the installation of universal catalytic converters is still permitted (check local regulations before installing).
- Full Stainless Steel construction, including the substrate which is furnace braised to the mantle for outstanding durability.
- Features proprietary precious metal loading technology that ensures greatly reduced emissions, eliminating almost all CEL issues.
- Capable of withstanding up to 1500°F (815°C).
- Ideal for forced induction applications (less than 1% flow degradation).



Covered by a 5 year, 50,000 mile / 80,000 km warranty (on converter shell and tube ends only).

Vehicle Emissions Inspection Report

Overall Result	Emissions	Evaporative Systems	Equipment Inspection	Smoke	OBD Codes
PASS	PASS	PASS	PASS	PASS	PASS

EMISSIONS TEST INFORMATION			
	READINGS	LIMITS	RESULTS
HC GPM	0.0430	1.200	PASS
CO GPM	0.540	15.000	PASS
NOx GPM	0.059	1.5000	PASS
Check Engine Light			PASS

Part No.	Inlet/Outlet	Converter Body O.D.	Overall Length	Engine Limit Per Bank	Substrate Cell Count
7525	2.50" (63.5mm)	4.00" (101.6mm)	7.00" (177.8mm)	350-500HP	300 cells / inch ²
7530	3.00" (76.2mm)	4.00" (101.6mm)	7.00" (177.8mm)	350-500HP	300 cells / inch ²
7830	3.00" (76.2mm)	4.50" (114.3mm)	7.00" (177.8mm)	500-850HP	300 cells / inch ²
7835	3.50" (88.9mm)	4.50" (114.3mm)	7.00" (177.8mm)	500-850HP	300 cells / inch ²
7840	4.00" (101.6mm)	4.50" (114.3mm)	7.00" (177.8mm)	500-850HP	300 cells / inch ²

Universal OBD1 High Flow Catalytic Converters

- For use on OBD1 vehicles (1995 and older) in jurisdictions where the installation of Universal Catalytic Converters is still permitted (check local regulations before installing).
- Full Stainless Steel Construction, including the substrate. Capable of withstanding higher operating temperatures than a typical ceramic core catalytic converter.
- Not for use in forced induction applications.
- Suitable for use on engines up to 5.0L.



Covered by a 5 year, 50,000 mile / 80,000 km warranty (on converter shell and tube ends only).

Part No.	Inlet/Outlet	Converter Body O.D.	Overall Length	Substrate Cell Count
7100	2.25" (57.2mm)	4.00" (101.6mm)	8.00" (203.2mm)	200 cells / inch ²
7101	2.50" (63.5mm)	4.00" (101.6mm)	8.00" (203.2mm)	200 cells / inch ²
7102	3.00" (76.2mm)	4.00" (101.6mm)	8.00" (203.2mm)	200 cells / inch ²

Exhaust Bungs

Part No.	Description	Material	Package Quantity
1194A	Standard O ² Sensor Weld Bung (M18 x 1.5 Thread)	304 Stainless Steel	1 / bag
1194	Standard O ² Sensor Weld Bung (M18 x 1.5 Thread)	304 Stainless Steel	5 / bag
11194	Standard O ² Sensor Weld Bung (M18 x 1.5 Thread)	304 Stainless Steel	100 / box
11105	Standard O ² Sensor Weld Bung (M18 x 1.5 Thread)	Mild Steel	1 / bag
11103	Standard O ² Sensor Weld Bung (M18 x 1.5 Thread)	Mild Steel	5 / bag
11104	Standard O ² Sensor Weld Bung (M18 x 1.5 Thread)	Mild Steel	100 / box
1194T	Standard O ² Sensor Weld Bung (M18 x 1.5 Thread)	Titanium	1 / bag



Part No.	Description	Material	Package Quantity
1188	Saddle style O ² Sensor Weld Bung (M18 x 1.5 Thread)	304 Stainless Steel	1 / bag
11188	Saddle style O ² Sensor Weld Bung (M18 x 1.5 Thread)	304 Stainless Steel	5 / bag



Part No.	Description	Material	Package Quantity
1193A	30° Angled O ² Sensor Weld Bung (M18 x 1.5 Thread)	304 Stainless Steel	1 / bag
1193	30° Angled O ² Sensor Weld Bung (M18 x 1.5 Thread)	304 Stainless Steel	5 / bag
11193	30° Angled O ² Sensor Weld Bung (M18 x 1.5 Thread)	304 Stainless Steel	100 / box



Part No.	Description	Material	Package Quantity
1192	"J" Style O ² Sensor Weld Bung (M18 x 1.5 Thread)	304 Stainless Steel	1 / bag



Part No.	Description	Material	Package Quantity
11620	Thread-On "J" Style O ² Sensor Bung (M18 x 1.5 Thread) Male end of fitting threads into existing Female O ² Sensor Bung with M18 x 1.5 Thread	304 Stainless Steel	1 / bag



Part No.	Description	Material	Package Quantity
1195A	Hex Head O ² Sensor Bung Plug (M18 x 1.5 Thread)	Zinc Plated Mild Steel	1 / bag
1195	Hex Head O ² Sensor Bung Plug (M18 x 1.5 Thread)	Zinc Plated Mild Steel	5 / bag
11195	Hex Head O ² Sensor Bung Plug (M18 x 1.5 Thread)	Zinc Plated Mild Steel	100 / box



Part No.	Description	Material	Package Quantity
1197	EGT Sensor Weld Bung (1/8" NPT Thread)	304 Stainless Steel	1 / bag
1197T	EGT Sensor Weld Bung (1/8" NPT Thread)	Titanium	1 / bag
11147	Socket Plug for EGT Sensor Bung (1/8" NPT Thread)	Zinc Plated Mild Steel	1 / bag



Specialty Oxygen Sensor Bungs

Part No.	Description	Material	Package Quantity
11621	Thread-On O ² Sensor Bung with Interchangeable Inserts (M18 x 1.5 Thread) Male end of fitting threads into existing Female O ² Sensor Bung with M18 x 1.5 Thread	304 Stainless Steel	1 / bag



Part No.	Description	Material	Package Quantity
11619	Thread-On "J-style" O ² Sensor Bung with Interchangeable Inserts (M18 x 1.5 Thread) Male end of fitting threads into existing Female O ² Sensor Bung with M18 x 1.5 Thread	304 Stainless Steel	1 / bag



Exhaust Accessories and Hardware

Vibrant Performance has assembled an extensive offering of hard to find, top quality and affordably priced exhaust accessories and hardware to simplify the life of professional fabricators, whether they are working on trucks, cars, motorcycles or off-road vehicles.

Torca® TC Series Stainless Steel Butt Joint Couplers



These Heavy Duty Exhaust Clamps allow for very secure sealing of butt-joint connections.

Part No.	Use With
1171	2.50" (63.5mm) O.D. Tubing
1176	2.75" (69.9mm) O.D. Tubing
11730	3.00" (76.2mm) O.D. Tubing
1177	3.50" (88.9mm) O.D. Tubing

Torca® Easy Seal Stainless Steel Sleeve Clamps



Easy Seal Clamps provide simple and cost effective connection of exhaust components. No need to separate tubing before clamping.

Part No.	Use With
1179	2.00" (50.8mm) O.D. Tubing
1170	2.25" (57.2mm) O.D. Tubing
1172	3.00" (76.2mm) O.D. Tubing
1174	3.50" (88.9mm) O.D. Tubing
1178	4.00" (101.6mm) O.D. Tubing

Torca® Accuseal Stainless Steel Exhaust Clamps

Part No.	Use With	Band Width
1163	2.00" (50.8mm) O.D. Tubing	1.00" (25.4mm)
1164	2.25" (57.2mm) O.D. Tubing	1.00" (25.4mm)
1166	2.50" (63.5mm) O.D. Tubing	1.00" (25.4mm)
1169	2.75" (69.9mm) O.D. Tubing	1.00" (25.4mm)
1167	3.00" (76.2mm) O.D. Tubing	1.00" (25.4mm)
1162	3.50" (88.9mm) O.D. Tubing	1.00" (25.4mm)
1168	4.00" (101.6mm) O.D. Tubing	1.25" (31.8mm)



Accuseal Clamps provide superior clamping and sealing of overlap joints without permanently distorting the exhaust tubing.

Multi Layer Graphite Exhaust Gaskets (2-Bolt and 3-Bolt)

- Refer to Page 52 for matching flanges to these gaskets and corresponding dimensional data.



Description	2 Bolt Gasket Part No.	3 Bolt Gasket Part No.
2.00" (50.8mm) I.D. Gasket	1455	--
2.25" (57.2mm) I.D. Gasket	1456	1461
2.50" (63.5mm) I.D. Gasket	1457	1462
2.75" (69.9mm) I.D. Gasket	1465	1466
3.00" (76.2mm) I.D. Gasket	1458	1463
3.50" (88.9mm) I.D. Gasket	--	1464
4.00" (101.6mm) I.D. Gasket	1459	--

Donut Style Graphite Gaskets

Part No.	I.D.	O.D.	Height
2599B	2.55" (64.8mm)	3.29" (83.6mm)	0.625" (15.9mm)
10108G	2.53" (64.3mm)	3.37" (85.6mm)	0.50" (12.7mm)
10530	2.30" (58.4mm)	2.70" (68.6mm)	0.625" (15.9mm)
10531	2.03" (51.6mm)	2.53" (64.3mm)	0.625" (15.9mm)
10532	2.03" (51.6mm)	2.59" (65.8mm)	0.50" (12.7mm)
10533	1.78" (45.2mm)	2.34" (59.4mm)	0.50" (12.7mm)



300 Series Stainless Steel Exhaust Hanger Rods

Part No.	Hanger Rod Size	Package Quantity
11898	0.375" (9.5mm) dia x 9.00" (228.6mm) long	10
11899	0.50" (12.7mm) dia x 9.00" (228.6mm) long	10



Exhaust Hanger Rod Clips

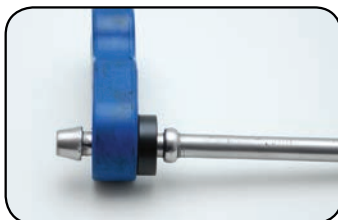

Vibrant Hanger Rod Clips, made from Delrin®, fill the gap when a hanger rod and rubber hanger does not fit snugly, minimizing the ability for an exhaust system to slide freely back and forth.

Part No.	Description	Package Quantity
1198C	Clips for 0.375" (9.5mm) dia Hanger Rods	2
1199C	Clips for 0.50" (12.7mm) dia Hanger Rods	2

Stainless Steel Fasteners

Part No.	Kit Contents
1450A	Package of 2 fastener sets (2 x M10 nuts & bolts, 4 washers)
1450B	Bulk Package of 25 fastener sets (25 x M10 nuts & bolts, 50 washers)



Spring Bolt Kits



Part No.	Description
10112	2 bolt, 10mm GM style Spring Bolt Kit (2 bolts, 2 nuts & 2 springs)
10113	3 bolt, 10mm GM style Spring Bolt Kit (3 bolts, 3 nuts & 3 springs)

Muffler Inner Silencer

When installed, this removable baffle helps deaden exhaust tone on Vibrant Performance TPV Universal Mufflers with 4" OD exhaust tips.

Part No.	O.D.	Tuning Tube Diameter
1184	3.90" (99.1mm)	2.50" (63.5mm)



Oxygen Sensor Socket Tool

This cut-away socket tool is designed to clear the O2 Sensor Wire and simplifies the installation or removal of an oxygen sensor.



Part No.	Description
11148	O2 Sensor Socket Tool (with 3/8" drive receiver)



Mufflers and Resonators

Vibrant Performance has one of the most complete offerings of mufflers & resonators in the industry which are a great upgrade for virtually any type car or truck as well as on or off-road vehicles and which are suitable for both naturally aspirated and forced induction applications.

Our "true straight through" internals feature a stainless steel perforated tube that is wrapped in our premium quality, multi-layer sound suppression materials that produce a low, deep tone while allowing for unrestricted flow and maximum horsepower.

Flat Black Universal Mufflers

- These stealthy mufflers are perfect for cruising under the radar and avoiding unwanted attention.
- Features 100% Stainless Steel construction.
- All Flat Black Mufflers measure 5"H x 9"W x 15"L (20" Overall Length, including the exhaust tips).

Single Outlet

Part No.	Inlet I.D.	Tip O.D.
1145	2.25" (57.2mm)	3.00" (76.2mm)
1146	2.50" (63.5mm)	3.00" (76.2mm)
1147	3.00" (76.2mm)	3.00" (76.2mm)
1153	3.50" (88.9mm)	3.50" (88.9mm)
1154	4.00" (101.6mm)	4.00" (101.6mm)



Round, Single Wall, Angle Cut

Dual Outlet

Part No.	Inlet I.D.	Tip O.D.	Center to Center
1148	2.50" (63.5mm)	3.00" (76.2mm)	3.25" (82.6mm)
1149	3.00" (76.2mm)	3.00" (76.2mm)	3.25" (82.6mm)
1155	4.00" (101.6mm)	3.00" (76.2mm)	3.25" (82.6mm)



Dual Round, Single Wall, Angle Cut

STREETPOWER Universal Mufflers (with Exhaust Tips)

- Don't be fooled by the classic, subtle style of the STREETPOWER range of Universal Performance Mufflers. Their "True Straight Through" Internals ensures unrestricted exhaust flow for maximum power.
- Feature durable 304 Stainless Steel construction, mirror polished.
- These Oval mufflers measure 5"H x 9"W x 15" Body Length (23" Overall Length).



Round, Single Wall, Angle Cut, Rolled Edge

Part No.	Inlet I.D.	Tip O.D.	Tip Length
1046	2.50" (63.5mm)	4.00" (101.6mm)	8.00" (203.2mm)
1042	3.00" (76.2mm)	4.00" (101.6mm)	8.00" (203.2mm)

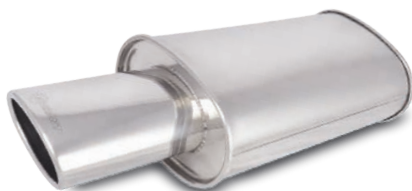

Oval, Single Wall, Angle Cut, Rolled Edge

Part No.	Inlet I.D.	Tip Dimension	Tip Length
1034	2.50" (63.5mm)	4.50" x 3.00" (114.3mm x 76.2mm)	8.00" (203.2mm)
1045	3.00" (76.2mm)	4.50" x 3.00" (114.3mm x 76.2mm)	8.00" (203.2mm)



Dual Round, Double Wall,
Straight Cut, Bevelled Edge

Part No.	Inlet I.D.	Tip O.D.	Tip Length	Center to Center
1040	2.50" (63.5mm)	3.50" (88.9mm)	8.00" (203.2mm)	3.75 (95.3mm)
1047	3.00" (76.2mm)	3.50" (88.9mm)	8.00" (203.2mm)	3.75 (95.3mm)



Dual Round, Double Wall,
Angle Cut, Rolled Edge

Part No.	Inlet I.D.	Tip O.D.	Tip Length	Center to Center
1024	2.25" (57.1mm)	3.00" (76.2mm)	8.00" (203.2mm)	3.75 (95.3mm)
1032	2.50" (63.5mm)	3.50" (88.9mm)	8.00" (203.2mm)	3.75 (95.3mm)
1043	3.00" (76.2mm)	3.50" (88.9mm)	8.00" (203.2mm)	3.75 (95.3mm)

TPV Universal Mufflers

- 304 Stainless Steel construction. Fully TIG welded for superior quality finish.
- All TPV Mufflers measure 6.25" OD.



4" Round, Straight Cut Tip

Part No.	Inlet ID	Tip OD	Overall Length	Tip Length
1057	2.50" (63.5mm)	4.00" (101.6mm)	23.00" (584.2mm)	8.00" (203.2mm)
1062	3.00" (76.2mm)	4.00" (101.6mm)	17.00" (431.8mm)	7.00" (177.8mm)
1059	3.00" (76.2mm)	4.00" (101.6mm)	23.00" (584.2mm)	8.00" (203.2mm)
1091	4.00" (101.6mm)	4.00" (101.6mm)	23.00" (584.2mm)	4.50" (114.3mm)



4" Round, Angle Cut Tip

Part No.	Inlet I.D.	Tip O.D.	Overall Length	Tip Length
1061	3.00" (76.2mm)	4.00" (101.6mm)	17.00" (431.8mm)	7.00" (177.8mm)
1058	3.00" (76.2mm)	4.00" (101.6mm)	23.00" (584.2mm)	8.00" (203.2mm)

STREETPOWER Oval Universal Mufflers

- STREETPOWER Mufflers offer a perfect balance of freeing up maximum power while effectively controlling exhaust tone.
- Features 304 Stainless Steel construction, Mirror Polished.
- These mufflers measure 5"H x 9"W x 15" Body Length.



Center - Center

Part No.	Inlet/Outlet I.D.	Overall Length
1101	2.25" (57.2mm)	20.00" (508mm)
1102	2.50" (63.5mm)	20.00" (508mm)
1132	2.75" (69.9mm)	20.00" (508mm)
1103	3.00" (76.2mm)	20.00" (508mm)
1135	3.50" (88.9mm)	20.00" (508mm)
1137	4.00" (101.6mm)	20.00" (508mm)



Center - Offset

Part No.	Inlet/Outlet I.D.	Overall Length
1105	2.25" (57.2mm)	20.00" (508mm)
1106	2.50" (63.5mm)	20.00" (508mm)
1107	3.00" (76.2mm)	20.00" (508mm)



Offset - Offset

Part No.	Inlet/Outlet I.D.	Overall Length
1126	2.50" (63.5mm)	20.00" (508mm)
1127	3.00" (76.2mm)	20.00" (508mm)



Center - Dual

Part No.	Inlet I.D.	Outlet O.D.	Overall Length
1110	2.50" (63.5mm)	2.25" (57.2mm)	20.00" (508mm)
1111	3.00" (76.2mm)	2.50" (63.5mm)	20.00" (508mm)

STREETPOWER Round Universal Mufflers

- 304 Stainless Steel construction, Mirror Polished.

Part No.	Inlet/Outlet I.D.	Muffler O.D.	Muffler Body Length	Overall Length
1117	2.25" (57.2mm)	6.00" (152.4mm)	14.00" (355.6mm)	19.00" (482.6mm)
1118	2.50" (63.5mm)	6.00" (152.4mm)	14.00" (355.6mm)	19.00" (482.6mm)
1119	3.00" (76.2mm)	6.00" (152.4mm)	14.00" (355.6mm)	19.00" (482.6mm)
1124	3.50" (88.9mm)	6.00" (152.4mm)	14.00" (355.6mm)	19.00" (482.6mm)
1139	4.00" (101.6mm)	7.00" (177.8mm)	18.00" (457.2mm)	22.00" (558.8mm)



Center - Center

Transverse Oval Universal Mufflers

- 304 Stainless Steel construction, Mirror Polished.
- These mufflers measure 6"H x 10"W x 24" Body Length.

Part No.	Inlet I.D.	Outlet O.D.	Overall Length
10633	2.50" (63.5mm)	2.25" (57.2mm)	24.00" (609.6mm)
10632	3.00" (76.2mm)	2.50" (63.5mm)	24.00" (609.6mm)
10635	3.50" (88.9mm)	3.00" (76.2mm)	24.00" (609.6mm)

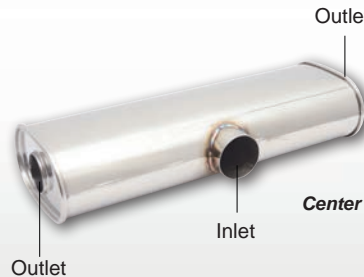

Center Inlet - Split Dual Outlet

Ultra Quiet Resonators

- Vibrant Ultra Quiet Resonators are the choice of exhaust professionals looking to reduce exhaust noise/droning from their performance exhaust setup.
- 304 Stainless Steel construction, Mirror Polished.

Part No.	Inlet / Outlet I.D.	Overall Length
1140	2.25" (57.2mm)	13.75" (349.3mm)
1141	2.50" (63.5mm)	13.75" (349.3mm)
1142	3.00" (76.2mm)	13.75" (349.3mm)



Center - Center

Muffler Body Dimension: 6.50" W x 4.75"H x 9.75" Body Length

Bottle Style Resonators

- 304 Stainless Steel construction, Mirror Polished.
- "True Straight Through" perforated core provides unrestricted exhaust flow while still reducing exhaust noise and drone.

Part No.	Inlet / Outlet I.D.	Body O.D.	Overall Length
1790	2.25" (57.2mm)	3.50" (88.9mm)	12.00" (304.8mm)
1791	2.25" (57.2mm)	3.50" (88.9mm)	18.00" (457.2mm)
1792	2.50" (63.5mm)	4.00" (101.6mm)	12.00" (304.8mm)
1793	2.50" (63.5mm)	4.00" (101.6mm)	18.00" (457.2mm)
1794	3.00" (76.2mm)	4.00" (101.6mm)	12.00" (304.8mm)
1795	3.00" (76.2mm)	4.00" (101.6mm)	18.00" (457.2mm)
17930	2.50" (63.5mm)	5.00" (127mm)	18.00" (457.2mm)
17950	3.00" (76.2mm)	5.00" (127mm)	18.00" (457.2mm)
17970	3.50" (88.9mm)	5.00" (127mm)	18.00" (457.2mm)
17960	4.00" (101.6mm)	5.00" (127mm)	18.00" (457.2mm)



Stainless Steel Race Mufflers

- Very Lightweight and Compact.
- Ideal for passing visual inspection at racetracks where mufflers are required.
- Manufactured from durable 304 Stainless Steel.
- Available in 5" and 9" Lengths.

Part No.	Inlet / Outlet I.D.	Muffler O.D.	Overall Length
1769	3.00" (76.2mm)	3.50" (88.9mm)	9.00" (228.6mm)
1796	3.50" (88.9mm)	4.125" (104.8mm)	9.00" (228.6mm)
1797	4.00" (101.6mm)	4.50" (114.3mm)	9.00" (228.6mm)
1799	5.00" (127mm)	5.50" (139.7mm)	9.00" (228.6mm)

Part No.	Inlet / Outlet I.D.	Muffler O.D.	Overall Length
17695	3.00" (76.2mm)	3.75" (95.3mm)	5.00" (127mm)
17965	3.50" (88.9mm)	4.125" (104.8mm)	5.00" (127mm)
17975	4.00" (101.6mm)	4.50" (114.3mm)	5.00" (127mm)
17985	4.50" (114.3mm)	5.125" (130.2mm)	5.00" (127mm)
17995	5.00" (127mm)	5.50" (139.7mm)	5.00" (127mm)



Stainless Steel Exhaust Tips

All Vibrant Performance exhaust tips are made from 304 Stainless Steel for optimum corrosion resistance and then undergo a three stage polishing process for a brilliant, mirror-like finish.

Part No.	Outlet O.D.	Inlet I.D.	Overall Length
1339	3.50" (88.9mm)	2.50" (63.5mm)	10.00" (254mm)



Double Wall, Straight Cut, Bevelled Edge



Double Wall, Straight Cut, Bevelled Edge

Part No.	Outlet O.D.	Inlet I.D.	Overall Length
1339B	3.50" (88.9mm)	2.50" (63.5mm)	10.00" (254mm)

Part No.	Outlet O.D.	Inlet I.D.	Overall Length
1326	3.50" (88.9mm)	2.50" (63.5mm)	10.00" (254mm)



Single Wall, Angle Cut, Rolled Edge



Single Wall, Angle Cut, Rolled Edge

Part No.	Outlet O.D.	Inlet I.D.	Overall Length
1326B	3.50" (88.9mm)	2.50" (63.5mm)	10.00" (254mm)

Part No.	Outlet O.D.	Inlet I.D.	Overall Length
1333	3.50" (88.9mm)	2.50" (63.5mm)	10.00" (254mm)



Single Wall, Angle Cut



Dual Oval, Single Wall, Angle Cut, Rolled Edge

Part No.	Outlet Size	Inlet I.D.	Overall Length
1335	3.25" x 2.75" (82.6mm x 69.9mm)	2.25" (57.2mm)	10.00" (254mm)

Part No.	Outlet O.D.	Inlet I.D.	Overall Length
1207	4.00" (101.6mm)	2.25" (57.2mm)	7.75" (196.9mm)
1226	3.50" (88.9mm)	2.25" (57.2mm)	7.50" (190.5mm)
1209	3.00" (76.2mm)	2.00" (50.8mm)	6.50" (165.1mm)



Double Wall, Bevelled Edge Angle Cut



Double Wall, Angle Cut, Rolled Edge

Part No.	Outlet O.D.	Inlet I.D.	Overall Length
1303	4.00" (101.6mm)	2.25" (57.2mm)	7.75" (196.9mm)

Stainless Steel Exhaust Tips (Continued)

Part No.	Outlet Size	Inlet I.D.	Overall Length
1405	5.50" x 3.00" (139.7mm x 76.2mm)	2.25" (57.2mm)	7.50" (190.5mm)

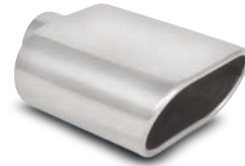

*Oval, Single Wall,
Angle Cut, Rolled Edge*



*Oval, Single Wall,
Angle Cut, Rolled Edge*

Part No.	Outlet Size	Inlet I.D.	Overall Length
1406	4.50" x 3.00" (114.3mm x 76.2mm)	2.50" (63.5mm)	7.75" (196.9mm)

Part No.	Outlet Dimension	Inlet I.D.	Overall Length
1607	7.75" x 1.875" (196.9mm x 47.6mm)	2.25" (57.2mm)	9.50" (241.3mm)
1606	7.75" x 1.875" (196.9mm x 47.6mm)	2.50" (63.5mm)	9.50" (241.3mm)

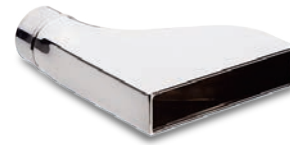

*Single Wall, Rolled Edge
Camaro Style*



Single Wall, Angle Cut

Part No.	Outlet O.D.	Inlet I.D.	Overall Length
1558	3.00" (76.2mm)	2.25" (57.2mm)	11.00" (279.4mm)
1559	3.00" (76.2mm)	2.50" (63.5mm)	11.00" (279.4mm)
1551	3.00" (76.2mm)	2.50" (63.5mm)	18.00" (457.2mm)
1561	3.50" (88.9mm)	3.00" (76.2mm)	11.00" (279.4mm)
1554	3.50" (88.9mm)	2.50" (63.5mm)	20.00" (508mm)
1555	4.00" (101.6mm)	2.50" (63.5mm)	20.00" (508mm)
1557	4.00" (101.6mm)	3.00" (76.2mm)	20.00" (508mm)

Part No.	Outlet O.D.	Inlet I.D.	Overall Length
1575	3.00" (76.2mm)	2.50" (63.5mm)	11.00" (279.4mm)
1579	3.50" (88.9mm)	2.50" (63.5mm)	18.00" (457.2mm)
1578	3.50" (88.9mm)	3.00" (76.2mm)	11.00" (279.4mm)
1583	4.00" (101.6mm)	2.50" (63.5mm)	18.00" (457.2mm)



Single Wall, Angle Cut, Rolled Edge



*Single Wall, Angle Cut, Rolled Edge
Bolt-on style*

Part No.	Outlet O.D.	Inlet I.D.	Overall Length
1503	3.00" (76.2mm)	2.25" (57.2mm)	5.50" (139.7mm)



Heat and Acoustic Shields

Vibrant Performance has partnered with DCI Performance Products to bring their industry leading Heat and Acoustic Shielding to North America. DCI is a leading OEM supplier of shielding solutions for many of the world's top On-Road and Off-Road vehicle manufacturers. Their patented technology allows them to build superior quality heat and acoustic shields that are lightweight, easy to install, cost effective and also recyclable.

Heat Shields

Part No.	Sheet Size	Description	Maximum Temperature
25015L	26.75" x 17.00" (679.5mm x 431.8mm)	Formable Flat Sheet Stainless Steel Composite Material.	2190°F (1200°C)
25015S	11.8" x 9.00" (300mm x 230mm)	Formable Flat Sheet Stainless Steel Composite Material.	2190°F (1200°C)
25000L	27.50" x 11.25" (698.5mm x 285.8mm)	Formable Flat Sheet Multi Layer Aluminized Mild Steel Material	1830°F (1000°C)
25000S	11.75" x 9.00" (298.5mm x 228.6mm)	Formable Flat Sheet Multi Layer Aluminized Mild Steel Material	1830°F (1000°C)
25010L	27.50" x 12.50" (701mm x 320mm)	Formable Flat Sheet Single Layer Aluminized Mild Steel Material	1650°F (900°C)
25600L	26.75" x 17.00" (679.5mm x 431.8mm)	Formable but Very Rigid 6 Layer dimpled Aluminum Material	1100°F (600°C)
25600S	11.75" x 9.00" (298.5mm x 228.6mm)	Formable but Very Rigid 6 Layer dimpled Aluminum Material	1100°F (600°C)
25400L	26.75" x 17.00" (679.5mm x 431.8mm)	Highly Formable/Pliable Flat Sheet 4 Layer dimpled Aluminum Material	1100°F (600°C)
25400S	11.75" x 9.00" (298.5mm x 228.6mm)	Highly Formable/Pliable Flat Sheet 4 Layer dimpled Aluminum Material	1100°F (600°C)
25100L	26.75" x 17.00" (679.5mm x 431.8mm)	Lightweight and Formable Flat Sheet Single Layer dimpled Aluminum Material	950°F (510°C)
25200L	39.25" x 20.00" (997mm x 508mm)	Aluminized Fiberglass Sheet (Adhesive Backing) Highly Flexible. Ideal for Radiant Heat.	490°F (255°C)

Pre-formed Heat Shields

Part No.	Shield Dimensions / Application	Maximum Temperature
25312	Fits 2.00" to 3.00" O.D. (50.8mm to 76.2mm) straight tubing - 12.00" long (304.8mm long)	1100°F (600°C)
25324	Fits 2.00" to 3.00" O.D. (50.8mm to 76.2mm) straight tubing - 24.00" long (609.6mm long)	1100°F (600°C)
25527	Fits 5.00" O.D. (127mm) straight tubing - 18.00" long (457.2mm long)	1100°F (600°C)
25390	Fits 2.00" to 3.00" O.D. (50.8mm to 76.2mm) 90° tubing – 8.00" CLR, 18.00" long (457.2mm long)	1100°F (600°C)
25591	Fits 5.00" O.D. (127mm) 90° tubing – 11.00" bend radius, 20.00" long (508mm long)	1100°F (600°C)
25035	Turbo Heat Shield - fits up to Garrett GT30/GT35 Turbo Housing (includes mounting hardware)	1830°F (1000°C)

Acoustic Shield

Part No.	Sheet Size	Description	Maximum Temperature
25770L	30.00" x 26.75" (762mm x 679.5mm)	Superior sound suppression properties due to premium butyl material with single layer of dimpled aluminum. Features adhesive backing.	390°F (200°C)

Windshield Washer Bottle

The factory Windshield Washer Bottle on most vehicles tends to be very large, eating up valuable space in the engine bay space.

This problem is especially troublesome for anyone who tries to install an aftermarket turbocharger or supercharger kit.

Vibrant Performance offers a convenient solution to this common problem with our incredibly compact universal washer bottle kit, which includes everything you would need to replace the OEM washer fluid tank.



Each kit includes:

- A rugged plastic Washer Bottle,
- Electric Pump,
- Electric Plug with wire,
- Mounting Bracket,
- a Length of Hose to adapt to the factory system.

Part No.	Description
10400	Universal Washer Bottle Kit (1.2L capacity)

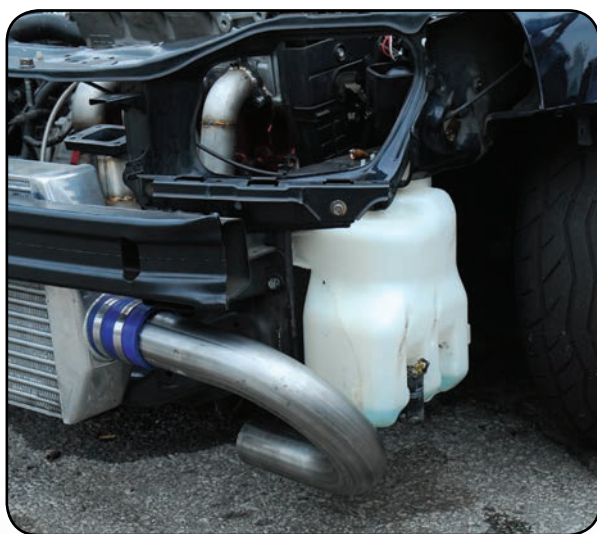

The typical OEM washer bottle can create significant clearance issues under a vehicle.



Vibrant Performance washer bottles are very compact allowing for much more space for aftermarket add-ons.