

# VANTECH



# TABLE OF CONTENTS

## PRODUCT OVERVIEW

---

- 2-3 H1 RACK SYSTEM
- 4-5 H2 RACK SYSTEM
- 6-7 H3 / J SERIES RACK SYSTEM
- 8-9 M SERIES RACK SYSTEM
- 10-11 P3000 RACK SYSTEM

## RACK SYSTEM PACKAGES

---

- 12-17 FORD TRANSIT CARGO 2015-ON
- 18-23 RAM ProMASTER 2013-ON
- 24-29 NISSAN NV CARGO VAN 2012-ON
- 30-35 MERCEDES SPRINTER 2007-ON
- 36-41 FULLSIZE VANS
  - DODGE RAM VAN
  - DODGE/MERCEDES/FREIGHTLINER SPRINTER
  - FORD ECONOLINE
  - CHEVY EXPRESS / GMC SAVANA
- 42-43 CONVERSION VANS
- 44-47 BOX TRUCK
- 48-53 TRANSIT CONNECT 2008-13
- 54-59 TRANSIT CONNECT 2014-ON
- 60-65 NISSAN NV200 / CHEVY EXPRESS CITY
- 66-71 RAM ProMASTER CITY
- 72-77 MERCEDES BENZ METRIS
- 78-85 MIDSIZE VEHICLES
- 86-87 FACTORY LUGGAGE RAILS
- 88-103 PICKUPS
  - 88-89 RAM RAMBox
  - 90-91 CHEVY AVALANCHE / ESCALADE
  - 92-93 HONDA RIDGELINE
  - 94-95 CLAMP-ON / BOLT-ON
- 96-103 TOPPER & CAP
- 104-114 ACCESSORIES
- 115-118 REPLACEMENT PARTS

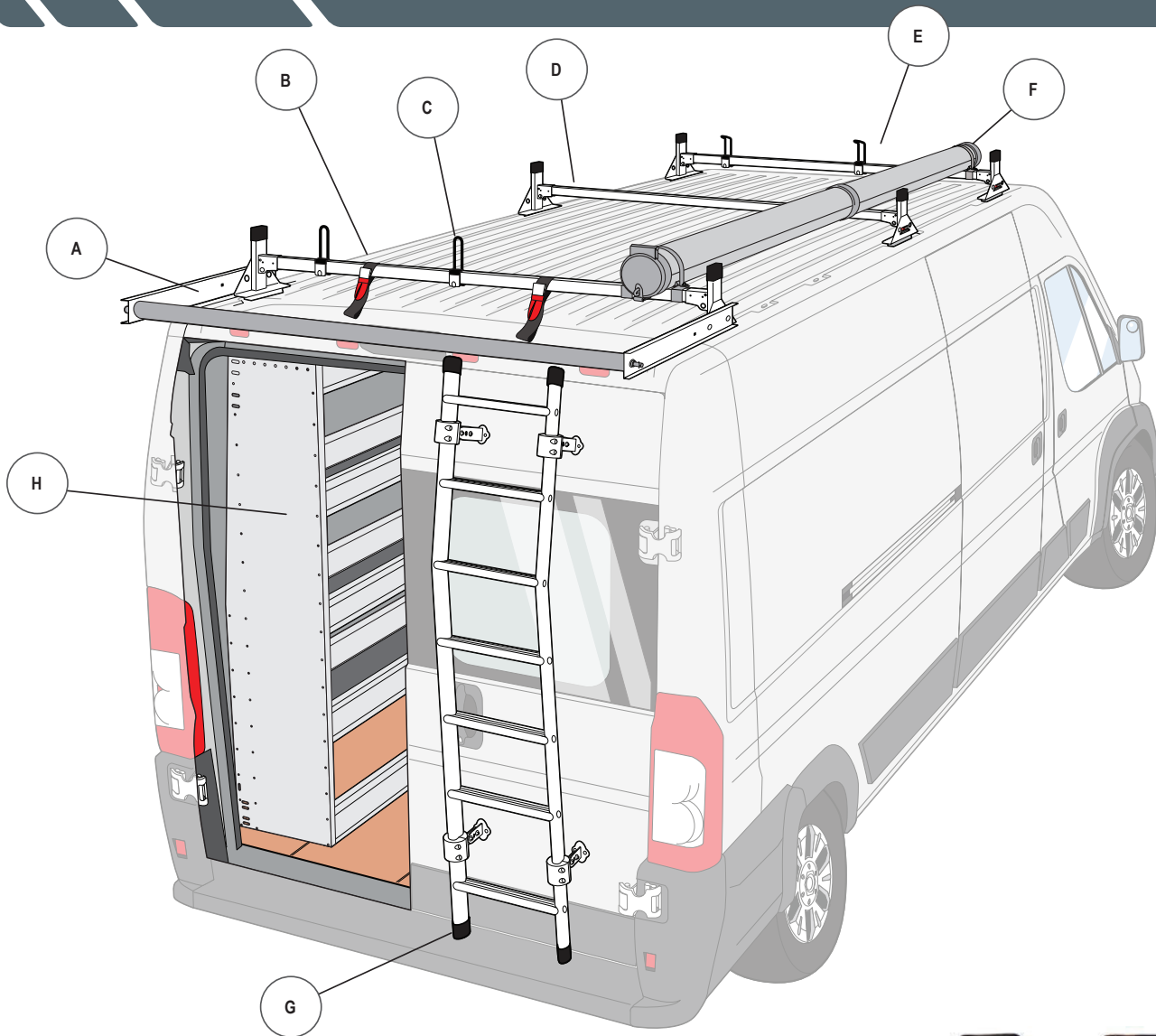

**H1 ACCESSORIES**

- A ROLLER SYSTEM**
- B Hook and loop fastener**
- C LADDER GUIDE**
- D BAR GUARD**
- E LADDER STOPPER**
- F CONDUIT CARRIER**

**ALSO SHOWN**

- G REAR ACCESS LADDER**
- H ALUMINUM SHELVING**





## HI RACK SYSTEM

› Available for the following vehicles:

Ford Transit cargo  
Nissan NV cargo  
Chevy Express  
RAM ProMaster  
Sprinter 2002-06  
Box Trucks

Ford Transit Connect  
Nissan NV200  
Chevy City Express  
RAM ProMaster City  
Sprinter 2007-on  
Mercedes Benz Metris

Dodge Ram Van  
Ford Econoline  
GMC Savana  
Midsize Vehicle  
Toppers & Caps

- › Vehicle specific fitment
- › Available in low, standard, high and custom profile
- › Bases are welded complete onto upright post for water tight seal
- › Extra wide 8" mounting bases
- › 4 x .75" eyehooks per mounting base for easy tie down
- › Crossbars: 1" x 2"

### STEEL SYSTEM

- › Anti-rust interior
- › Powder coated finish
- › 14 gauge post & cross bars
- › 11 gauge mounting bases
- › Colors available: black or white

### STAINLESS STEEL SYSTEM

- › Longer lasting durability
- › Made with type 304 stainless steel
- › Rust free
- › Corrosion free
- › Heavy duty
- › 13 gauge mounting bases
- › 17 gauge cross bars
- › Colors available: stainless steel

### ALUMINUM SYSTEM

- › Lightweight Design
- › Made of 6061 aircraft grade aluminum
- › Stainless steel hardware
- › Rust free
- › Anodized finish
- › Extruded reinforced cross bars
- › Colors available: black, white or silver





**H2 ACCESSORIES**

- A** eZ Hook and loop fastener StraP
- B** H2 ROLLER SYSTEM
- C** CONDUIT CARRIER
- D** BAR GUARD
- E** LADDER STOPPER

**ALSO SHOWN**

- G** ALUMINUM SHELVEING
- H** REAR ACCESS LADDER





## H2 RACK SYSTEM

---

› Available for the following vehicles:

Ford Transit cargo  
Nissan NV cargo  
Chevy Express  
RAM ProMaster  
Sprinter 2007-on  
Ford Econoline  
GMC Savana  
Toppers & Caps

Ford Transit Connect all years  
Nissan NV200  
Chevy City Express  
RAM ProMaster City  
Midsize Vehicle  
Dodge Ram Van  
Box Trucks  
Mercedes Benz Metris

- › All aluminum design
- › Lightweight
- › Rust free
- › Vehicle specific fitment
- › Stainless steel hardware
- › Multiple cross bars at 16" apart
- › Extruded reinforced cross bars
- › 2.25" x 1" cross bars
- › Built-in channels on the cargo rails and cross bars for additional accessories
- › Cargo rails available from 72" - 168"
- › Cross bars available from 60" - 72"
- › Rear roller allows easy loading and unloading
- › Adjustable roller can extend past edge of roof
- › Colors available: black, white or silver



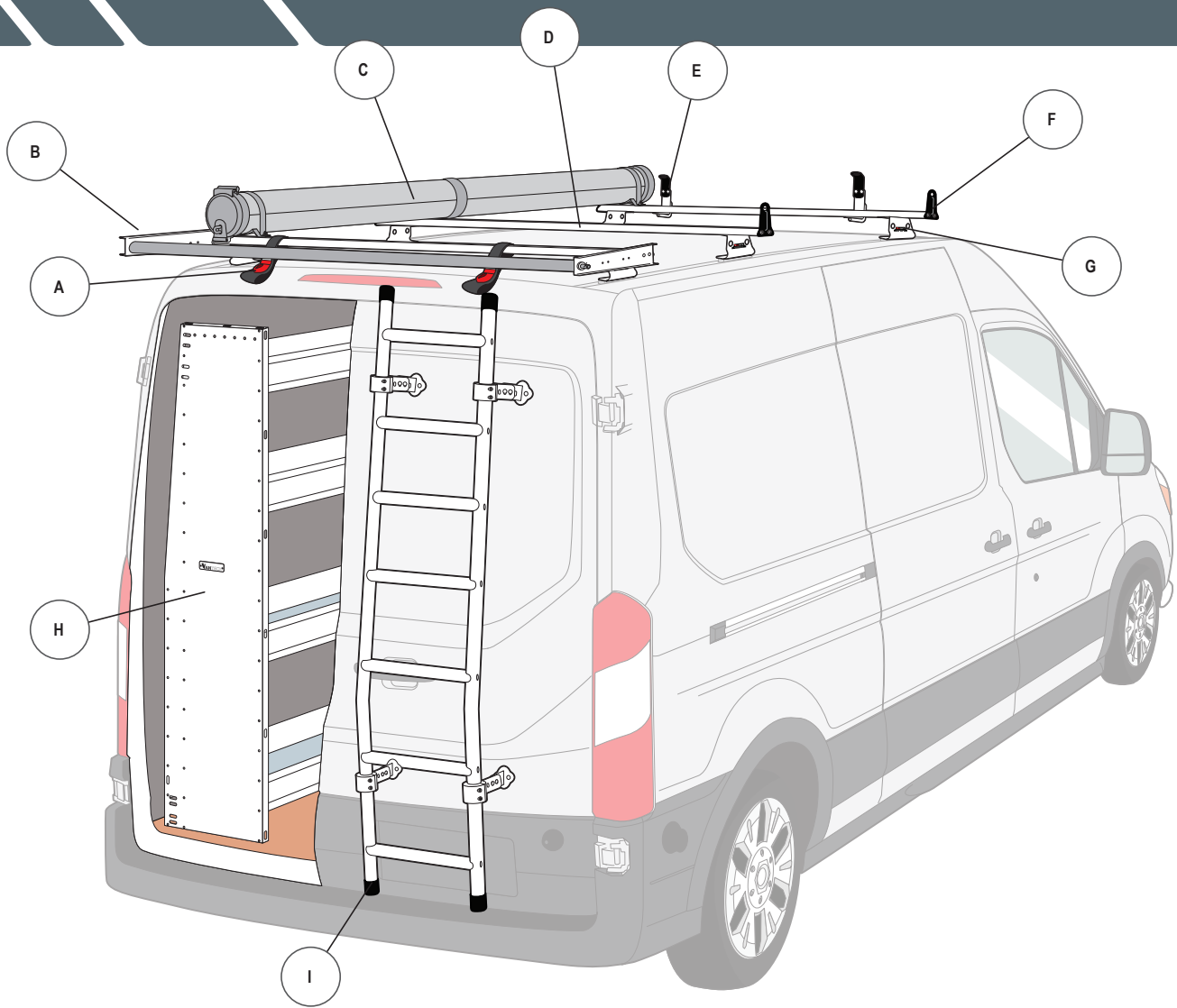

**H3 / J SERIES ACCESSORIES**

- A eZ Hook and loop fastener Strap
- B H3 EXTENDED ROLLER SYSTEM
- C CONDUIT CARRIER
- D BAR GUARD
- E LADDER STOPPER
- F SIDE SUPPORT
- G HEAVY DUTY MOUNT

**ALSO SHOWN**

- H ALUMINUM SHELVING
- I REAR ACCESS LADDER



# H3/J SERIES RACK SYSTEM



## H3 / J SERIES RACK SYSTEM

- Available for the following vehicles:

Ford Transit cargo  
Nissan NV cargo  
Chevy Express  
RAM ProMaster  
Sprinter 2007-on  
Ford Econoline  
GMC Savana  
Toppers & Caps

Ford Transit Connect all years  
Nissan NV200  
Chevy City Express  
RAM ProMaster City  
Midsize Vehicle  
Dodge Ram Van  
Box Trucks  
Mercedes Benz Metris

- All aluminum design
- Lightweight
- Rust free
- Minimal vibration and wind noise
- Vehicle specific fitment
- Stainless steel hardware
- Extruded reinforced cross bars
- Cross bar length available from 50" - 72"
- Built-in channels on the cross bars for additional accessories
- Side supports available for all application
- Colors available: black, white or silver





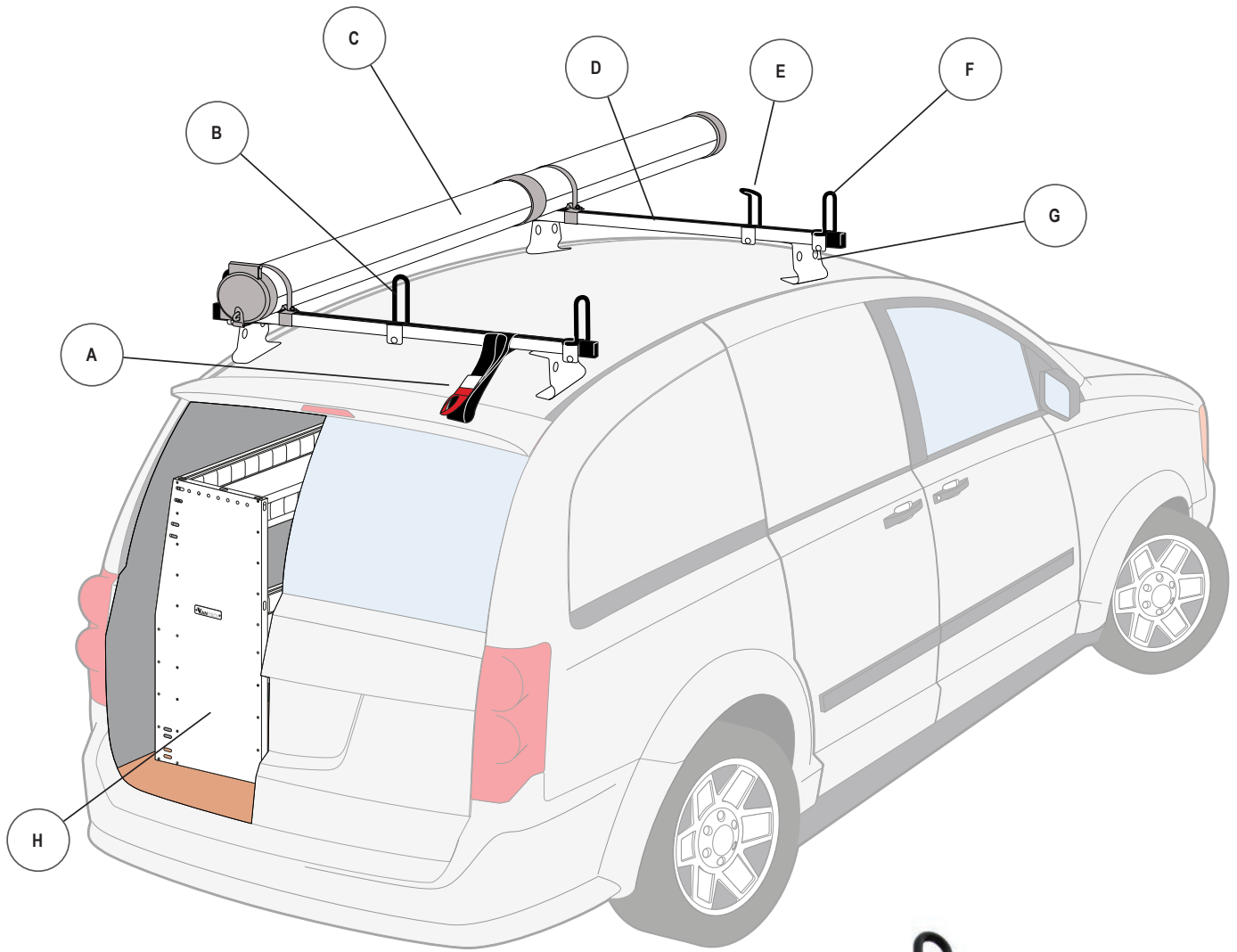

**M SERIES ACCESSORIES**

- A eZ Hook and loop fastener StraP
- B LADDER GUIDE
- C CONDUIT CARRIER
- D BAR GUARD
- E LADDER STOPPER
- F SIDE SUPPORT
- G HEAVY DUTY MOUNT

**ALSO SHOWN**

- H ALUMINUM SHELVING



# M SERIES RACK SYSTEM



## M SERIES RACK SYSTEM V

- Available for the following vehicles:
  - Box Trucks
  - Midsized Vehicles
  - Topper & Cap
- Available in steel and aluminum
- Universal fitment
- Drilling required
- Bolts onto aluminum, steel or fiberglass body
- 6" x 1.5" extra wide mounting bases
- 2 x .75" eyehooks per mounting base for easy tie down
- Polyfoam gaskets for tight seal
- 10.75" total height with support
- 5.25" total height without support
- Cross bar length available from 50" - 84"

### STEEL SYSTEM

- 14 gauge cross bar 1.5" x 1"
- 11 gauge mounting bases
- Anti-rust interior
- Powder coated finish
- Maximum load capacity 500lbs
- Colors available: black or white

### ALUMINUM SYSTEM

- Lightweight Design
- Made of 6061 aircraft grade
- Stainless steel hardware
- Rust free
- Anodized finish
- Extruded reinforced cross bars 1.5" x 1"
- Maximum load capacity 500lbs
- Colors available: black or white



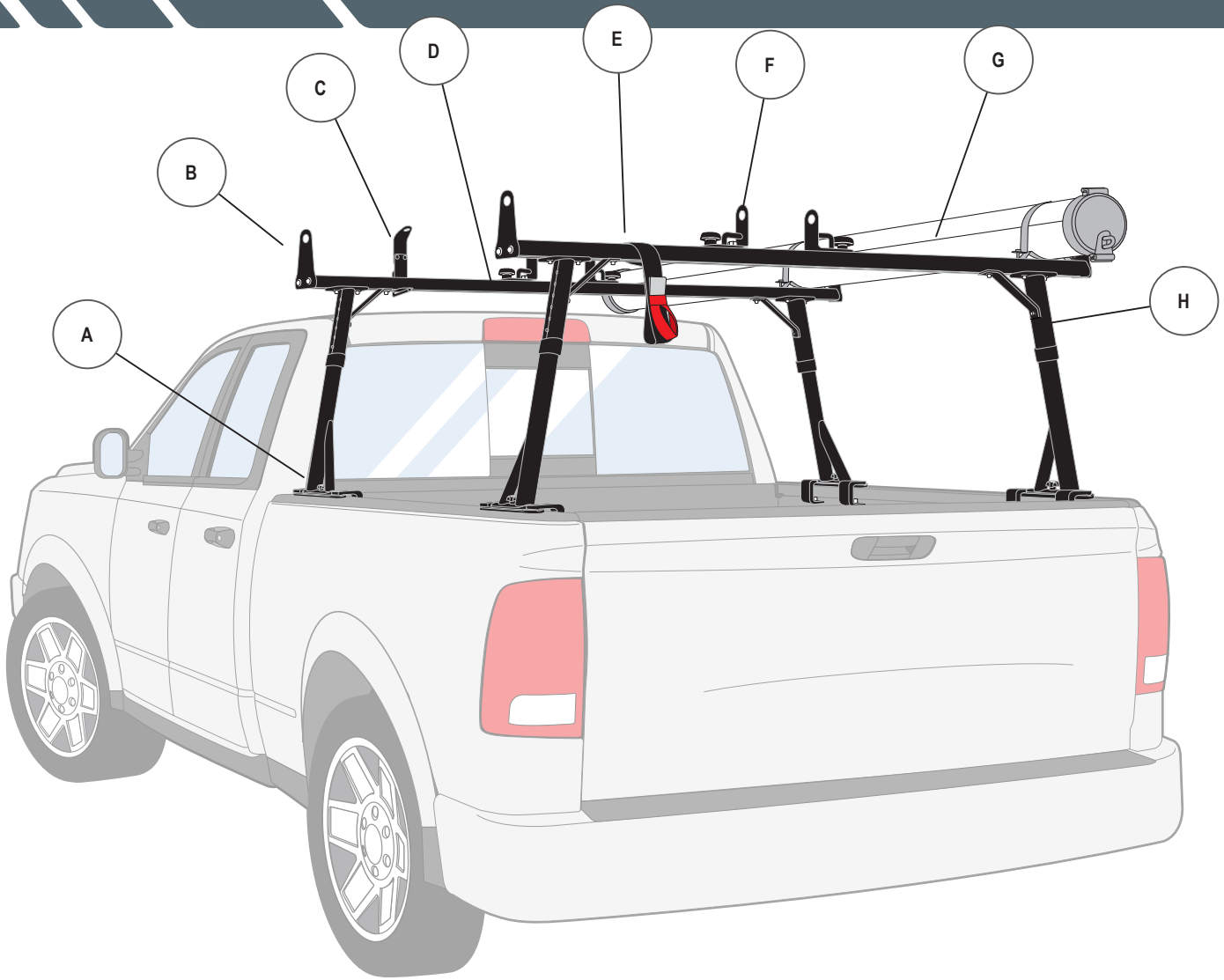

**P3000 ACCESSORIES**

- A HEAVY DUTY PICKUP CLAMP**
- B A286 SIDE SUPPORTS**
- C LADDER STOPPER**
- D RUBBER BAR GUARD**
- E ADJUSTABLE GUIDE CONDUIT**
- F CARRIER ADJUSTABLE HEIGHT**
- G MOUNTS**



# P3000 RACK SYSTEMS



## P3000 RACK SYSTEM

- ▶ Available for the following vehicles:
    - ▶ Midsize pickup                      Fullsize pickup
    - ▶ Topper & Cap                        Utility pickup
  - ▶ All aluminum lightweight design
  - ▶ Clamp-on or bolt-on system (vehicle specific)
  - ▶ Rust free
  - ▶ Adjustable uprights from 21.25" - 34.75" (Extension Available)
  - ▶ Heavy duty 3" x 1.5"
  - ▶ Angled braces for additional support
  - ▶ Cross bar length available from 55" - 84"
  - ▶ Built-in channels on the cross bars for additional accessories
  - ▶ Anodized finish
  - ▶ Extension plates for topper and cap available
  - ▶ Color available:    black or silver
- ▶ We specialize in Honda Ridgeline, Chevy Avalanche, Cadillac Escalade and RAM RamBox

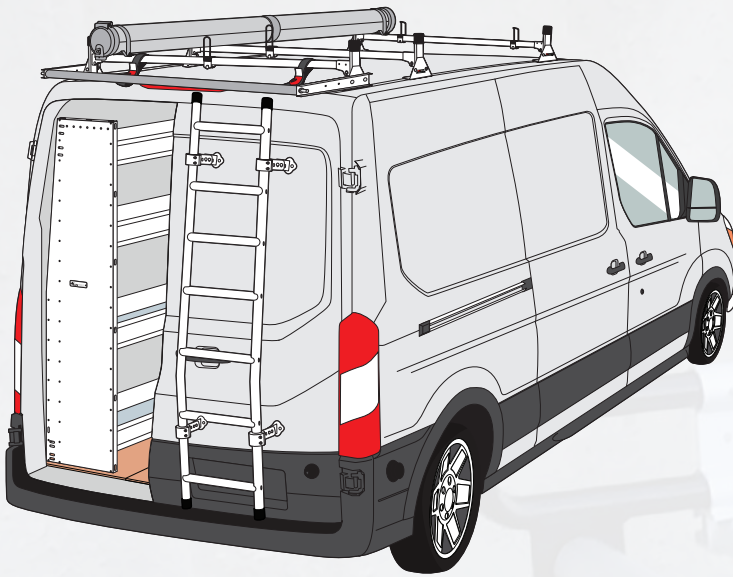

## H1 RACK SYSTEM

- › Fastens onto existing factory mounting points
- › Fits low, medium and high roof (all wheelbases)
- › 54" wide loading area
- › 10" low profile mounting bases
- › 4 x .75" eyehooks per mounting base for easy tie down
- › Materials available: steel, aluminum or stainless steel
- › Colors available: black, white or silver



### STEEL SYSTEM

- › Heavy duty grade
  - › Economical
- ### ALUMINUM SYSTEM
- › Rust free
  - › Stainless steel hardware
  - › Lightweight

### STAINLESS STEEL SYSTEM

- › Rust free
- › Stainless steel hardware
- › Longer lasting durability

(more info see page 3)

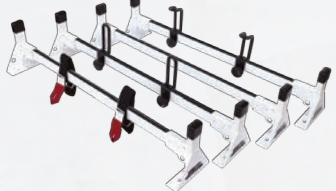
H1 Rack Systems	Description	Material	Color	Capacity
	2 Bar System	Steel	B / W	500 lbs.
	Included acc. 1 x Ladder Stopper 1 x Ladder Guide 1 x Hook and loop fastener Strap	Aluminum	B / W / S	500 lbs.
		Stainless	SS	600 lbs.
	3 Bar System	Steel	B / W	750 lbs.
	Included acc. 2 x Ladder Stopper 2 x Ladder Guide 2 x Hook and loop fastener Strap	Aluminum	B / W / S	750 lbs.
		Stainless	SS	900 lbs.
	4 Bar System	Steel	B / W	1000 lbs.
	Included acc. 2 x Ladder Stopper 2 x Ladder Guide 2 x Hook and loop fastener Strap	Aluminum	B / W / S	1000 lbs.
		Stainless	SS	1200 lbs.

## H1 Accessories



### Part #

A69

#### eZ Hook and loop fastener Strap

- › Strap loops onto cross bar
- › Capacity: 75 lbs.
- › Fitment: All Vantech cross bars
- › Material: Nylon
- › Color: Black & red



### Part #

A02

#### Ladder Guide

- › Height: 5.5" tall
- › Fitment: H series (1" x 2")
- › Material: Galvanized steel
- › Finish: Black rubber



### Part #

A06

#### Ladder Stopper

- › Height: 5" tall
- › Fitment: H series (1" x 2")
- › Material: Galvanized steel
- › Finish: Black rubber

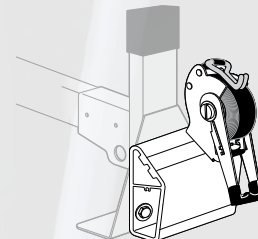

### Part #

RTD10-H1

#### Ratchet Tie-Down

- › Bolt-on system (no drilling required)
- › Self contained strap
- › Strap: 1.5" x 120"
- › Material: Stainless steel/Aluminum

## H1 Accessories



Part #	Length
BG-054	54"

### Plastic Bar Guard

- ▶ Textured plastic surface
- ▶ Adhesive backing
- ▶ Fitment: ST or SS cross bars
- ▶ Material: Plastic
- ▶ Color: Black

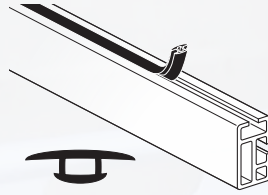

Part #	Length
BG-546	46"

### Rubber Bar Guard

- ▶ Non-slip rubber surface
- ▶ Press-In installation method
- ▶ Fitment: A613 cross bars
- ▶ Material: Rubber
- ▶ Color: Black

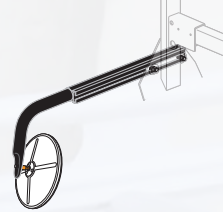

Part #	Adjustment
A81	25"-32"

### Back-Up 8" Convex Mirror

- ▶ Installs onto eye hooks
- ▶ Material: Aluminum
- ▶ Color: Anodized black



Part #	Width
WF-56	56"

### Wind Foil

- ▶ Decreases wind noise and vibrations
- ▶ Does not interfere with accessories
- ▶ Material: Aluminum
- ▶ Color: Anodized black  
Powder coated white

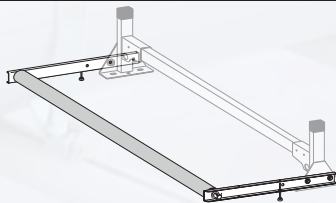

PART #	Max Extension
ROH124-57	24"
ROH136-57	32"

### Roller Extension

- ▶ Adjustable 16"-32"
- ▶ Adjustable riser for added support
- ▶ Material: Aluminum
- ▶ Color: Anodized black  
Anodized silver  
Powder coated white
- ▶ Roller only available in silver  
(See page 106 for dimensions)

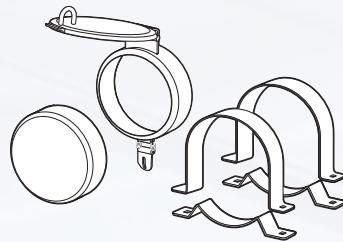

PART #
A40

- ▶ **6" Conduit Hatch & Cap**
- ▶ No drilling required.
- ▶ Includes: Cross bar clamps
- ▶ Material: Aluminum
- ▶ Color: Anodized black  
Anodized silver  
Powder coated white

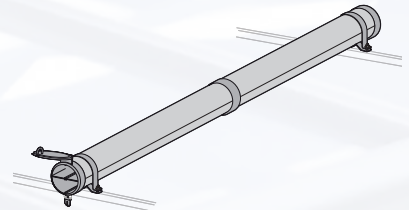

Part #	Description
CC-104	2 Compartment

### 6" x 128" Conduit Carrier Kit

- ▶ 3 or 4 compartments available (see page 110)
- ▶ Material: Aluminum
- ▶ Color: Anodized black  
Anodized silver  
Powder coated white
- ▶ Tube only available in silver

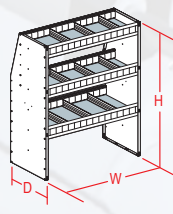
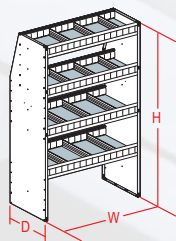

### Aluminum Interior Shelving

- ▶ Fitment: Ford Transit Cargo 2015-On
- ▶ Material: Aluminum
- ▶ Color: Silver

Height	Depth	Levels	Width 42"	Width 48"	Width 60"
48" Low / Medium Roof	13"	3	SA4842-3	SA4848-3	SA4860-3
60" High Roof	13"	4	SA6042-4	SA6048-4	SA6060-4

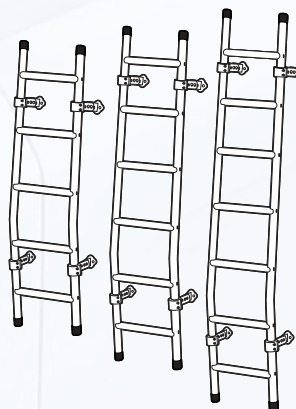

### Rear Access Ladder



- ▶ Fitment: Ford Transit Cargo 2015-On
- ▶ Material: Aluminum
- ▶ Color: Anodized black  
Anodized silver  
Powder coated white

Height	Vehicles
56"	Low Roof L001
68"	Medium Roof L003
83"	High Roof L004



## H2 RACK SYSTEM

- › Fastens onto existing factory mounting points
- › Fits low, medium and high roof (all wheelbases)
- › All aluminum design
- › Multiple cross bars at 16" apart
- › 2.25" x 1" x 65" cross bars
- › Built-in channels on the cargo rails and cross bars for additional accessories
- › Cargo rail lengths available in 120", 144" and 168"
- › Rear adjustable roller allows for easy loading and unloading
- › Roller can extend beyond the edge of the roof
- › Colors available: black, white or silver

H2 Rack System	Description	Cross Bar	Material	Color	Capacity
	H2 120" Cargo System	65"	Aluminum	B / W / S	900 lbs.
	H2 144" Cargo System	65"	Aluminum	B / W / S	900 lbs.
	H2 168" Cargo System	65"	Aluminum	B / W / S	900 lbs.

## H2 Accessories



### Part #

A20

#### Adjustable Guide

- › Height: 5" tall
- › Fitment: Cross bars with channels
- › Material: Galvanized steel rubber dipped

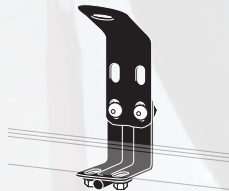

### Part #

A57

#### Ladder Stopper

- › Height: 5-7" tall
- › Material: Galvanized steel rubber dipped
- › Color: Black

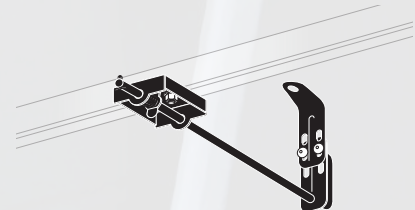

### Part #

A64

#### Push 2 Secure

- › Secure and lock ladder
- › Material: Galvanized steel rubber dipped
- › Color: Black

## H2 Accessories

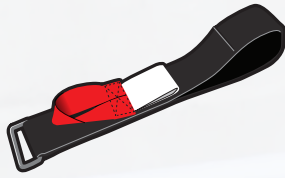

**Part #**

A69

**EZ Hook and loop fastener Strap**

- › Strap loops onto cross bar
- › Capacity: 75 lbs.
- › Fitment: All Vantech cross bars
- › Material: Nylon
- › Color: Black & red

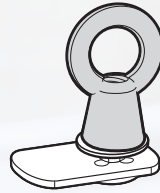

**Part #      Size**

A24      1"  
A59      1.25"

**Eye hook**

- › Fitment: Slides into aluminum channels
- › Material: Stainless steel
- › Color: Silver

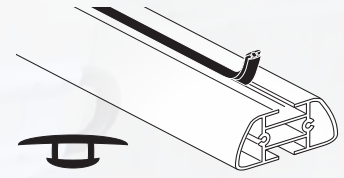

**Part #      Length**

BG-564      64"

**Rubber Bar Guard**

- › Non-slip rubber surface
- › Press-In installation method
- › Fitment: A285 cross bars
- › Material: Rubber
- › Color: Black

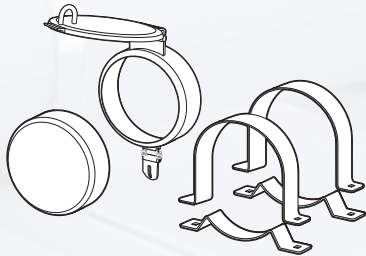

**PART #**

A34

**6" Conduit Carrier Hatch & Cap**

- › No drilling required
- › Secures to bars with sliders.
- › Material: Aluminum
- › Color: Anodized black  
Anodized silver  
Powder coated white

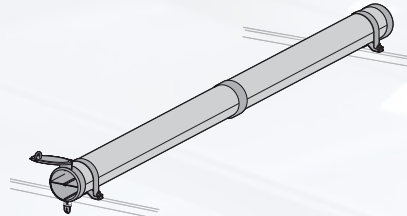

**Part #      Description**

CC-101      2 Compartment

**6" x 128" Conduit Carrier Kit**

- › 3 or 4 compartments available (see page 110)
- › Material: Aluminum
- › Color: Anodized black  
Anodized silver  
Powder coated white
- › Tube only available in silver

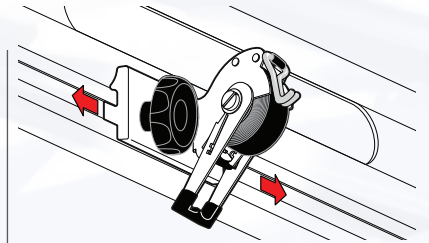

**Part #**

RTD10-H2

- › **Ratchet Tie-Down**
- › Bolt-on system (no drilling required)
- › Self contained strap
- › Strap: 1.5" x 120"
- › Material: Stainless steel/Aluminum

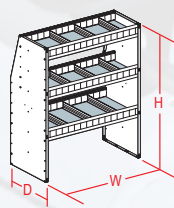
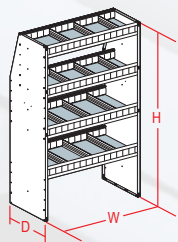

**Aluminum Interior Shelving**

- › Fitment: Ford Transit Cargo 2015-On
- › Material: Aluminum
- › Color: Silver

Height	Depth	Levels	Width 42"	Width 48"	Width 60"
48" Low / Medium Roof	13"	3	SA4842-3	SA4848-3	SA4860-3
60" High Roof	13"	4	SA6042-4	SA6048-4	SA6060-4

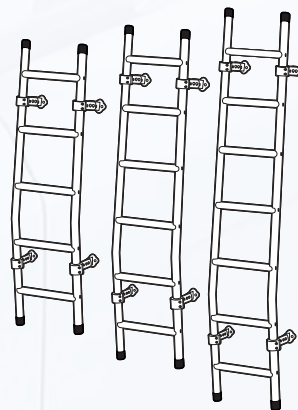

**Rear Access Ladder**

- › Fitment: Ford Transit Cargo 2015-On
- › Material: Aluminum
- › Color: Anodized black  
Anodized silver  
Powder coated white



Height	Vehicles
56"	Low Roof    L001
68"	Medium Roof    L003
83"	High Roof    L004

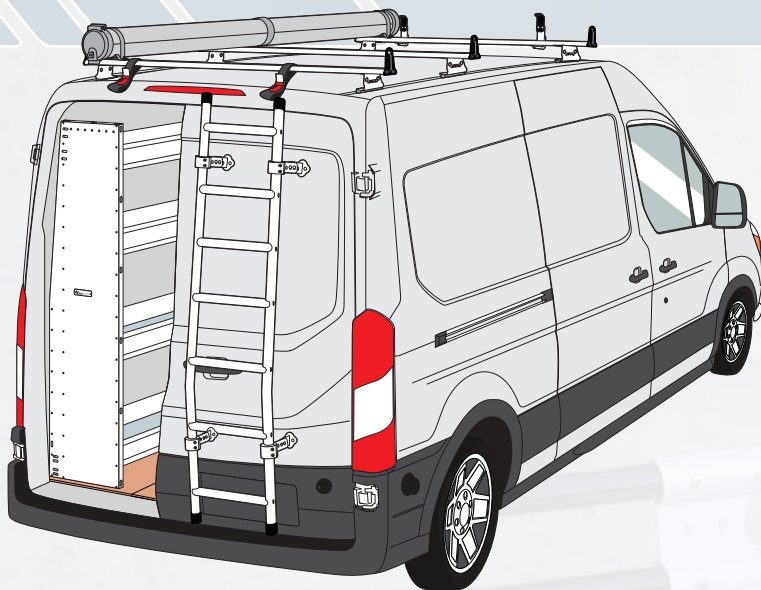



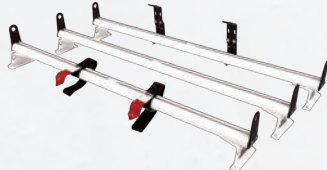

## H3 RACK SYSTEM

- › Fastens onto existing factory mounting points
- › Fits low, medium and high roof (all wheelbases)
- › All aluminum design
- › 6" wide mounting bases
- › Heavy duty 1/8" thick mounting bases
- › 3" x 1.5" x 65" cross bars
- › Built-in channels on the cross bars for additional accessories
- › 2 x .75" eyehooks per mounting base for easy tie down
- › Colors available: black, white or silver

H3 Rack System	Description	Material	Color	Capacity	
	2 Bar System	Aluminum	B / W / S	500 lbs.	H3702
	3 Bar System	Aluminum	B / W / S	750 lbs.	H3703
	2 Bar System Includes: 1 x Ladder Stopper 1 x Hook and loop fastener Strap 4 x Side Supports	Aluminum	B / W / S	500 lbs.	H3712
	3 Bar System Includes: 2 x Ladder Stopper 2 x Hook and loop fastener Straps 6 x Side Supports	Aluminum	B / W / S	750 lbs.	H3713

## H3 Accessories

			
<b>Part #</b> A03	<b>Part #</b> A20	<b>Part #</b> A57	<b>Part #</b> A64
<b>Side Support</b> › Height : 4" tall from top of cross bar › Fitment: A286 cross bars › Material: Galvanized steel rubber dipped	<b>Adjustable Guide</b> › Height: 5" tall › Fitment: Cross bars with channels › Material: Galvanized steel rubber dipped	<b>Ladder Stopper</b> › Height: 5-7" tall › Material: Galvanized steel rubber dipped › Color: Black	<b>Push 2 Secure</b> › Secure and lock ladder › Material: Galvanized steel rubber dipped › Color: Black

## H3 Accessories

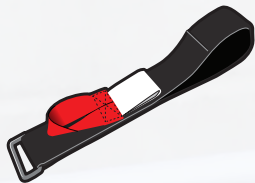

**Part #**

A69

**EZ Hook and loop fastener Strap**

- › Strap loops onto cross bar
- › Capacity: 75 lbs.
- › Fitment: All Vantech cross bars
- › Material: Nylon
- › Color: Black & red

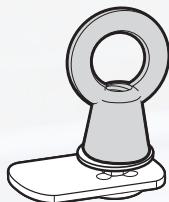

**Part # Size**

A24 1"

A59 1.25"

**1" Eye hook**

- › Fitment: Slides into aluminum channels
- › Material: Stainless steel
- › Color: Silver

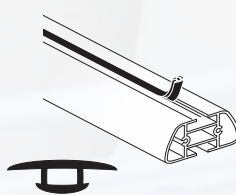

**Part # Length**

BG-565 65"

**Rubber Bar Guard**

- › Non-slip rubber surface
- › Press-In installation method
- › Fitment: A286 cross bars
- › Material: Rubber
- › Color: Black

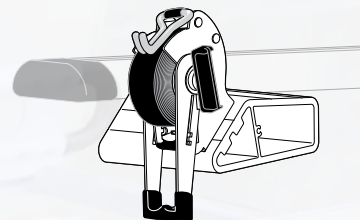

**Part #**

RTD10-H3

**› Ratchet Tie-Down**

- › Bolt-on system (no drilling required)
- › Self contained strap
- › Strap: 1.5" x 120"
- › Material: Stainless steel/Aluminum

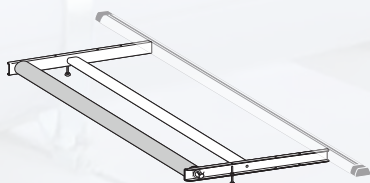

**PART # Max Extension**

ROH324-50 20"

ROH336-50 32"

**Roller Extension**

- › Adjustable 10 - 32"
- › Fitment: A286 cross bars
- › Material: Aluminum
- › Color: Anodized black  
Anodized silver  
Powder coated white
- › Roller only available in silver  
(See page 107 for dimension)

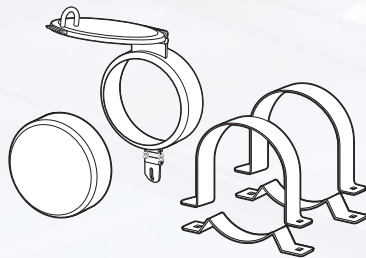

**PART #**

A34

**6" Conduit Hatch & Cap**

- › No drilling required
- › Secures to bars with sliders
- › Material: Aluminum
- › Color: Anodized black  
Anodized silver  
Powder coated white

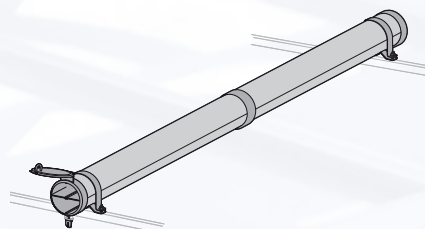

**Part # Description**

CC-101 2 Compartment

**6" x 128" Conduit Carrier Kit**

- › 3 or 4 compartments available (see page 110)
- › Material: Aluminum
- › Color: Anodized black  
Anodized silver  
Powder coated white
- › Tube only available in silver

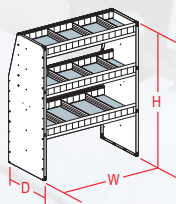
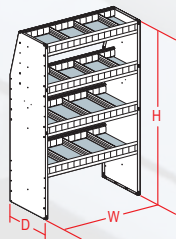

**Aluminum Interior Shelving**

- › Fitment: Ford Transit Cargo 2015-On
- › Material: Aluminum
- › Color: Silver

Height	Depth	Levels	Width 42"	Width 48"	Width 60"
48"					
Low / Medium Roof	13"	3	SA4842-3	SA4848-3	SA4860-3
60"					
High Roof	13"	4	SA6042-4	SA6048-4	SA6060-4

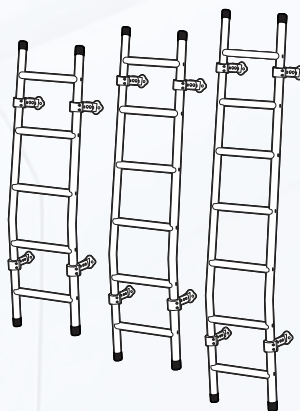

**Rear Access Ladder**

- › Fitment: Ford Transit Cargo 2015-On
- › Material: Aluminum
- › Color: Anodized black  
Anodized silver  
Powder coated white

Height	Vehicles	
56"	Low Roof	L001
68"	Medium Roof	L003
83"	High Roof	L004

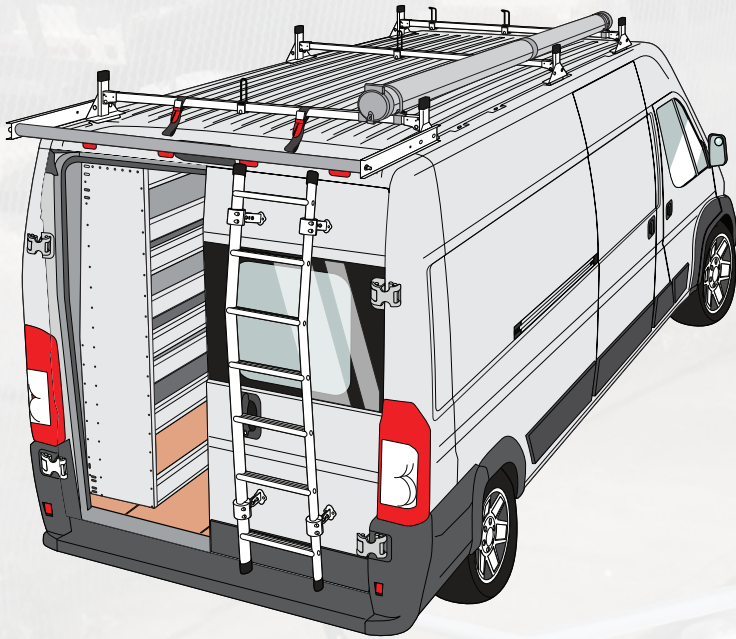

## H1 RACK SYSTEM

- › Fastens onto existing factory mounting points
- › Fits low and high roof (all wheelbases)
- › 57" wide loading area
- › 10" low profile mounting bases
- › 4 x .75" eyehooks per mounting base for easy tie down
- › Materials available: steel, aluminum or stainless steel
- › Colors available: black, white or silver



### STEEL SYSTEM

- › Heavy duty grade
  - › Economical
- ### ALUMINUM SYSTEM
- › Rust free
  - › Stainless steel hardware
  - › Lightweight

### STAINLESS STEEL SYSTEM

- › Rust free
- › Stainless steel hardware
- › Longer lasting durability

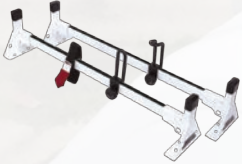
(more info see page 3)

H1 Rack System	Description	Material	Color	Weight Capacity	MSRP
	2 Bar System	ST	B / W	500 lbs.	H1342
	Includes: 1 x Ladder Stopper	AL	B / W / S	500 lbs.	H1352
	1 x Ladder Guide 1 x Hook and loop fastener Strap	SS	SS	600 lbs.	H1362
	3 Bar System	ST	B / W	750 lbs.	H1343
	Includes: 2 x Ladder Stopper	AL	B / W / S	750 lbs.	H1353
	2 x Ladder Guide 2 x Hook and loop fastener Strap	SS	SS	900 lbs.	H1363
	4 Bar System	ST	B / W	1000 lbs.	H1344
	Includes: 2 x Ladder Stopper	AL	B / W / S	1000 lbs.	H1354
	2 x Ladder Guide 2 x Hook and loop fastener Strap	SS	SS	1200 lbs.	H1364

## H1 Accessories



Part #

A69

### EZ Hook and loop fastener Strap

- › Strap loops onto cross bar
- › Capacity: 75 lbs.
- › Fitment: All Vantech cross bars
- › Material: Nylon
- › Color: Black & red



Part #

A02

### Ladder Guide

- › Height: 5.5" tall
- › Fitment: H series (1" x 2")
- › Material: Galvanized steel
- › Finish: Black rubber



Part #

A06

### Ladder Stopper

- › Height: 5" tall
- › Fitment: H series (1" x 2")
- › Material: Galvanized steel
- › Finish: Black rubber

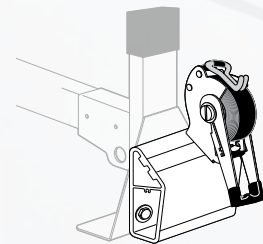

Part #

RTD10-H1

### Ratchet Tie-Down

- › Bolt-on system (no drilling required)
- › Self contained strap
- › Strap: 1.5" x 120"
- › Material: Stainless steel/Aluminum

## H1 Accessories

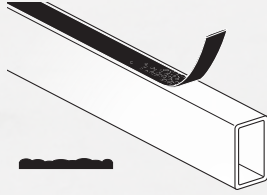

**Part # Length**

BG-057 57"

### Plastic Bar Guard

- Textured plastic surface
- Adhesive backing
- Fitment: ST or SS cross bars
- Material: Plastic
- Color: Black

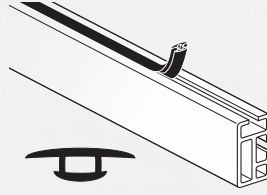

**Part # Length**

BG-549 49"

### Rubber Bar Guard

- Non-slip rubber surface
- Press-In installation method
- Fitment: A613 cross bars
- Material: Rubber
- Color: Black

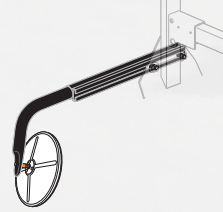

**Part # Adjustment**

A81 25"-32"

### Back-Up 8" Convex Mirror

- Installs onto eye hooks
- Material: Aluminum
- Color: Anodized black

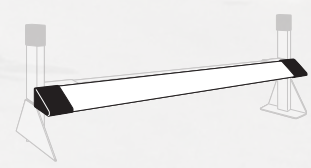

**Part # Length**

WF-59 59"

### Wind Foil

- Decreases wind noise and vibrations
- Does not interfere with accessories
- Material: Aluminum
- Color: Anodized black  
Powder coated white

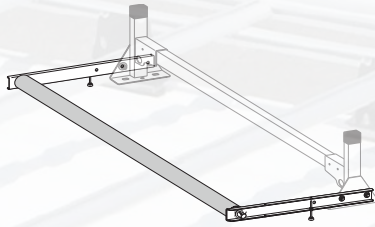

**PART # Max Extension**

ROH124-60 20"

### Roller Extension

- Adjustable 16" or 20"
- Adjustable riser for added support
- Material: Aluminum
- Color: Anodized black  
Anodized silver  
Powder coated white
- Roller only available in silver  
(See page 106 for dimensions)

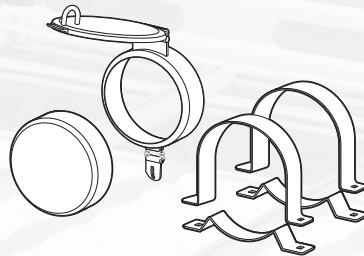

**PART #**

A40

- 6" Conduit Hatch & Cap
- No drilling required.
- Includes: Cross bar clamps
- Material: Aluminum
- Color: Anodized black  
Anodized silver  
Powder coated white

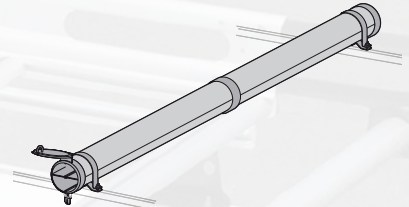

**Part # Description**

CC-104 2 Compartment

### 6" x 128" Conduit Carrier Kit

- 3 or 4 compartments available (see page 110)
- Material: Aluminum
- Color: Anodized black  
Anodized silver  
Powder coated white
- Tube only available in silver

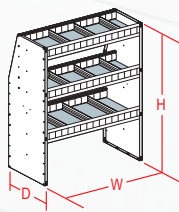
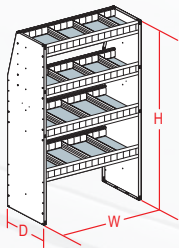

### Aluminum Interior Shelving

- Fitment: RAM ProMaster 2013-On
- Material: Aluminum
- Color: Silver

Height	Depth	Levels	Width 42"	Width 48"	Width 60"
48" Low Roof	13"	3	SA4842-3	SA4848-3	SA4860-3
60" High Roof	13"	4	SA6042-4	SA6048-4	SA6060-4

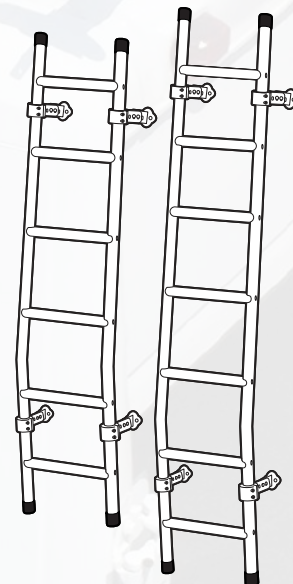

### Rear Access Ladder

- Fitment: RAM ProMaster 2013-On
- Material: Aluminum
- Color: Anodized black  
Anodized silver  
Powder coated white

**Height Vehicles**

68"	Low Roof	L003
83"	High Roof	L004



## H2 RACK SYSTEM

- › Fastens onto existing factory mounting points
- › Fits low and high roof (all wheelbases)
- › All aluminum design
- › Multiple cross bars at 16" apart
- › 2.25" x 1" x 65" cross bars
- › Built-in channels on the cargo rails and cross bars for additional accessories
- › Cargo rail lengths available in 120", 144" and 168"
- › Rear adjustable roller allows for easy loading and unloading
- › Roller can extend beyond the edge of the roof
- › Colors available: black, white or silver

H2 Rack System	Description	Cross Bar	Material	Color	Capacity	
	H2 120" Cargo System	65"	Aluminum	B / W / S	900 lbs.	H2555 (
	H2 144" Cargo System	65"	Aluminum	B / W / S	900 lbs.	H2556
	H2 168" Cargo System	65"	Aluminum	B / W / S	900 lbs.	H2557

## H2 Accessories



**Part #**

A20

### Adjustable Guide

- › Height: 5" tall
- › Fitment: Cross bars with channels
- › Material: Galvanized steel rubber dipped

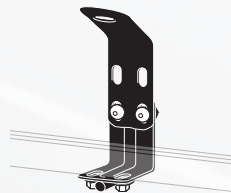

**Part #**

A57

### Ladder Stopper

- › Height: 5-7" tall
- › Material: Galvanized steel rubber dipped
- › Color: Black

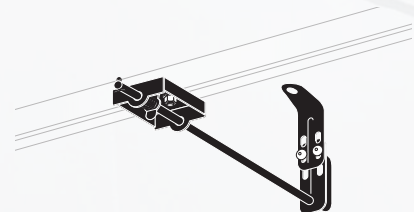

**Part #**

A64

### Push 2 Secure

- › Secure and lock ladder
- › Material: Galvanized steel rubber dipped
- › Color: Black

## H2 Accessories

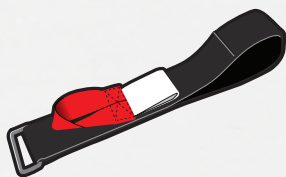

**Part #**

A69

**EZ Hook and loop fastener Strap**

- › Strap loops onto cross bar
- › Capacity: 75 lbs.
- › Fitment: All Vantech cross bars
- › Material: Nylon
- › Color: Black & red

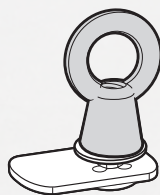

**Part #      Size**

A24      1"

A59      1.25"

**Eye hook**

- › Fitment: Slides into aluminum channels
- › Material: Stainless steel
- › Color: Silver



**Part #      Length**

BG-564      64"

**Rubber Bar Guard**

- › Non-slip rubber surface
- › Press-In installation method
- › Fitment: A285 cross bars
- › Material: Rubber
- › Color: Black

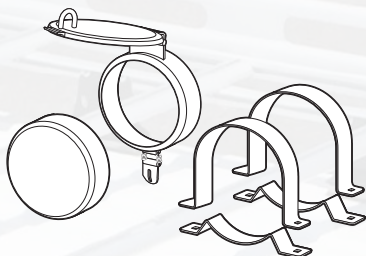

**PART #**

A34

**6" Conduit Carrier Hatch & Cap**

- › No drilling required
- › Secures to bars with sliders.
- › Material: Aluminum
- › Color: Anodized black  
Anodized silver  
Powder coated white

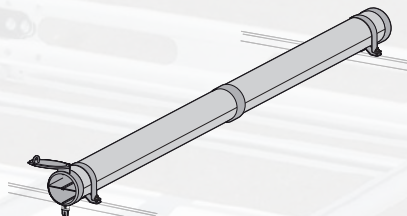

**Part #      Description**

CC-101      2 Compartment

**6" x 128" Conduit Carrier Kit**

- › 3 or 4 compartments available (see page 110)
- › Material: Aluminum
- › Color: Anodized black  
Anodized silver  
Powder coated white
- › Tube only available in silver

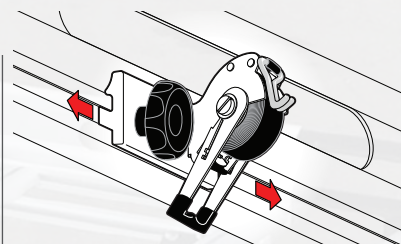

**Part #**

RTD10-H2

- › Ratchet Tie-Down
- › Bolt-on system (no drilling required)
- › Self contained strap
- › Strap: 1.5" x 120"
- › Material: Stainless steel/Aluminum

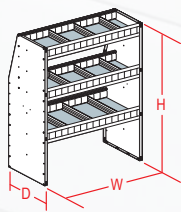
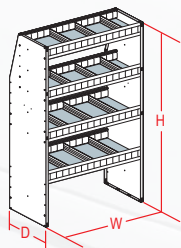

**Aluminum Interior Shelving**

- › Fitment: RAM ProMaster 2013-On
- › Material: Aluminum
- › Color: Silver

Height	Depth	Levels	Width 42"	Width 48"	Width 60"
48" Low Roof	13"	3	SA4842-3	SA4848-3	SA4860-3
60" High Roof	13"	4	SA6042-4	SA6048-4	SA6060-4

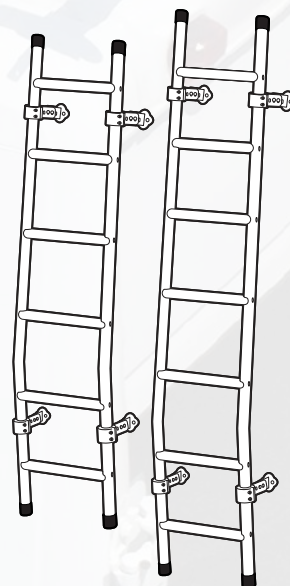

**Rear Access Ladder**

- › Fitment: RAM ProMaster 2013-On
- › Material: Aluminum
- › Color: Anodized black  
Anodized silver  
Powder coated white

Height	Vehicles	
68"	Low Roof	L003
83"	High Roof	L004

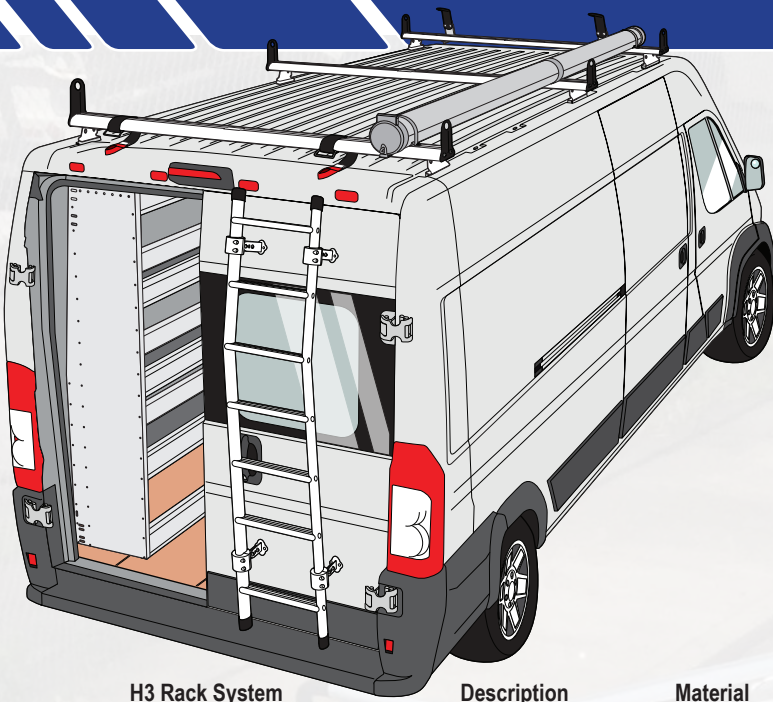

### H3 RACK SYSTEM

- › Fastens onto existing factory mounting points
- › Fits low and high roof (all wheelbases)
- › All aluminum design
- › 6" wide mounting bases
- › Heavy duty 1/8" thick mounting bases
- › 3" x 1.5" x 65" cross bars
- › Built-in channels on the cross bars for additional accessories
- › 2 x .75" eyehooks per mounting base for easy tie down
- › Colors available: black, white or silver

H3 Rack System	Description	Material	Color	Capacity	
	2 Bar System	Aluminum	B / W / S	500 lbs.	H3542
	3 Bar System	Aluminum	B / W / S	750 lbs.	H3543
	2 Bar System Included acc. 4 x Side Support 1 x Ladder Stopper 1 x Hook and loop fastener Strap	Aluminum	B / W / S	500 lbs.	H3552
	3 Bar System Included acc. 6 x Side Support 2 x Ladder Stopper 2 x Hook and loop fastener Strap	Aluminum	B / W / S	750 lbs.	H3553

### H3 Accessories

			
<b>Part #</b> A03	<b>Part #</b> A20	<b>Part #</b> A57	<b>Part #</b> A64
<b>Side Support</b> › Height : 4" tall from top of cross bar › Fitment: A286 cross bars › Material: Galvanized steel rubber dipped	<b>Adjustable Guide</b> › Height: 5" tall › Fitment: Cross bars with channels › Material: Galvanized steel rubber dipped	<b>Ladder Stopper</b> › Height: 5-7" tall › Material: Galvanized steel rubber dipped › Color: Black	<b>Push 2 Secure</b> › Secure and lock ladder › Material: Galvanized steel rubber dipped › Color: Black

## H3 Accessories

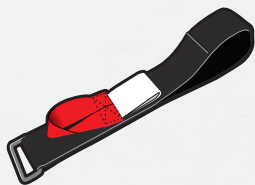

**Part #**

A69

**EZ Hook and loop fastener Strap**

- › Strap loops onto cross bar
- › Capacity: 75 lbs.
- › Fitment: All Vantech cross bars
- › Material: Nylon
- › Color: Black & red

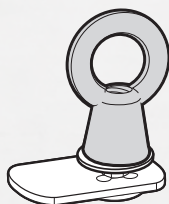

**Part # Size**

A24 1"

A59 1.25"

**1" Eye hook**

- › Fitment: Slides into aluminum channels
- › Material: Stainless steel
- › Color: Silver

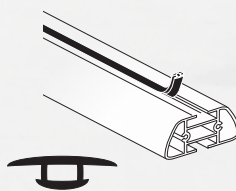

**Part # Length**

BG-565 65"

**Rubber Bar Guard**

- › Non-slip rubber surface
- › Press-In installation method
- › Fitment: A286 cross bars
- › Material: Rubber
- › Color: Black

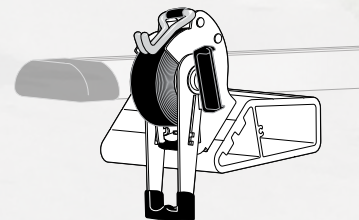

**Part #**

RTD10-H3

**› Ratchet Tie-Down**

- › Bolt-on system (no drilling required)
- › Self contained strap
- › Strap: 1.5" x 120"
- › Material: Stainless steel

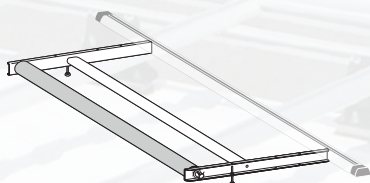

**PART # Max Extension**

ROH324-50 20"

**Roller Extension**

- › Adjustable 10" - 20"
- › Fitment: A286 cross bars
- › Material: Aluminum
- › Color: Anodized black  
Anodized silver  
Powder coated white
- › Roller only available in silver

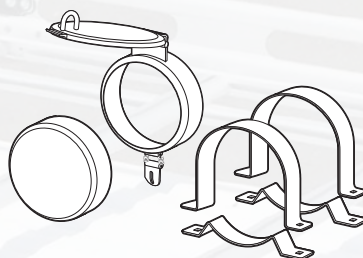

**PART #**

A34

**6" Conduit Hatch & Cap**

- › No drilling required
- › Secures to bars with sliders
- › Material: Aluminum
- › Color: Anodized black  
Anodized silver  
Powder coated white

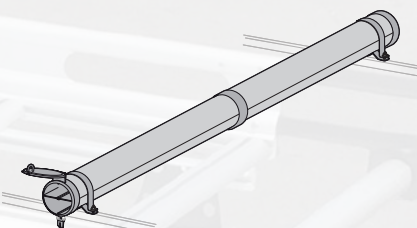

**Part # Description**

CC-101 2 Compartment

**6" x 128" Conduit Carrier Kit**

- › 3 or 4 compartments available (see page 110)
- › Material: Aluminum
- › Color: Anodized black  
Anodized silver  
Powder coated white
- › Tube only available in silver

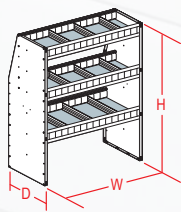
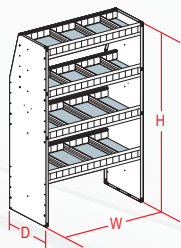

**Aluminum Interior Shelving**

- › Fitment: RAM ProMaster 2013-On
- › Material: Aluminum
- › Color: Silver

Height	Depth	Levels	Width 42"	Width 48"	Width 60"
48" Low Roof	13"	3	SA4842-3	SA4848-3	SA4860-3
60" High Roof	13"	4	SA6042-4	SA6048-4	SA6060-4

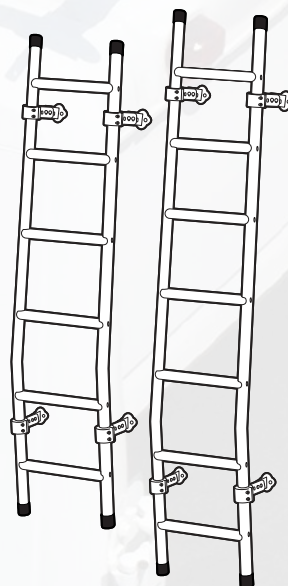

**Rear Access Ladder**

- › Fitment: RAM ProMaster 2013-On
- › Material: Aluminum
- › Color: Anodized black  
Anodized silver  
Powder coated white

Height	Vehicles	
68"	Low Roof	L003
83"	High Roof	L004



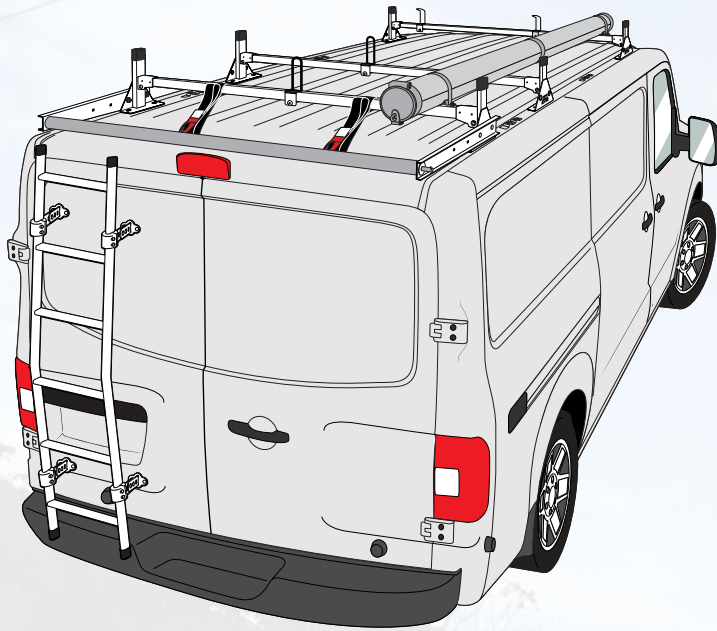

## H1 RACK SYSTEM

- › Fastens onto existing factory mounting points
- › Fits standard and high roof
- › 57" wide loading area
- › 10" low profile mounting bases
- › 4 x .75" eyehooks per mounting base for easy tie down
- › Materials available: steel, aluminum or stainless steel
- › Colors available: black, white or silver

### STEEL SYSTEM

- › Heavy duty grade
- › Economical

### STAINLESS STEEL SYSTEM

- › Rust free
- › Stainless steel hardware
- › Longer lasting durability



### ALUMINUM SYSTEM

- › Rust free
- › Stainless steel hardware
- › Lightweight

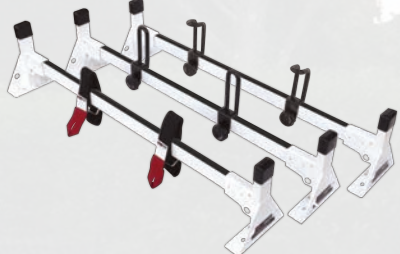
(more info see page 3)

H1 Rack System	Description	Material	Color	Weight Capacity	
	2 Bar System	ST	B / W	500 lbs.	H1302
	Includes: 1 x Ladder Stopper 1 x Ladder Guide	AL	B / W / S	500 lbs.	H1312
	1 x Hook and loop fastener Strap	SS	SS	600 lbs.	H1322
	3 Bar System	ST	B / W	750 lbs.	H1303
	Includes: 2 x Ladder Stopper 2 x Ladder Guide	AL	B / W / S	750 lbs.	H1313
	2 x Hook and loop fastener Strap	SS	SS	900 lbs.	H1323 (

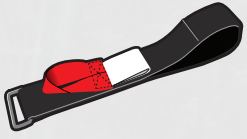
## H1 Accessories

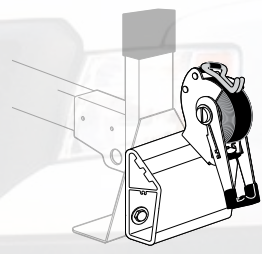
			
<b>Part #</b>	<b>Part #</b>	<b>Part #</b>	<b>Part #</b>
A69	A02	A06	RTD10-H1
<b>EZ Hook and loop fastener Strap</b>	<b>Ladder Guide</b>	<b>Ladder Stopper</b>	<b>Ratchet Tie-Down</b>
<ul style="list-style-type: none"> <li>› Strap loops onto cross bar</li> <li>› Capacity: 75 lbs.</li> <li>› Fitment: All Vantech cross bars</li> <li>› Material: Nylon</li> <li>› Color: Black &amp; red</li> </ul>	<ul style="list-style-type: none"> <li>› Height: 5.5" tall</li> <li>› Fitment: H series (1" x 2")</li> <li>› Material: Galvanized steel</li> <li>› Finish: Black rubber</li> </ul>	<ul style="list-style-type: none"> <li>› Height: 5" tall</li> <li>› Fitment: H series (1" x 2")</li> <li>› Material: Galvanized steel</li> <li>› Finish: Black rubber</li> </ul>	<ul style="list-style-type: none"> <li>› Bolt-on system (no drilling required)</li> <li>› Self contained strap</li> <li>› Strap: 1.5" x 120"</li> <li>› Material: Stainless steel/Aluminum</li> </ul>

## H1 Accessories



Part #	Length
BG-057	57"

### Plastic Bar Guard

- Textured plastic surface
- Adhesive backing
- Fitment: ST or SS cross bars
- Material: Plastic
- Color: Black

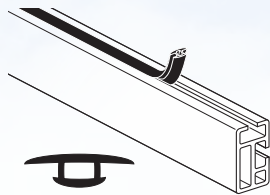

Part #	Length
BG-549	49"

### Rubber Bar Guard

- Non-slip rubber surface
- Press-In installation method
- Fitment: A613 cross bars
- Material: Rubber
- Color: Black

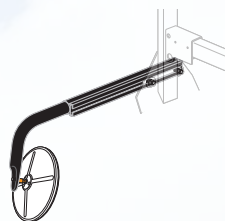

Part #	Adjustment
A81	25"-32"

### Back-Up 8" Convex Mirror

- Installs onto eye hooks
- Material: Aluminum
- Color: Anodized black

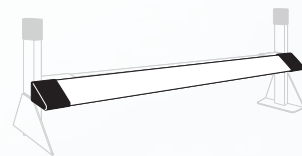

Part #	Size
WF-59	59"

### Wind Foil

- Decreases wind noise and vibrations
- Does not interfere with accessories
- Material: Aluminum
- Color: Anodized black  
Powder coated white

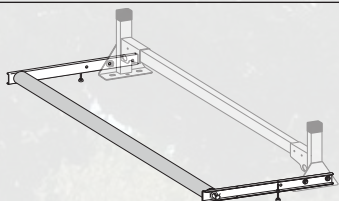

PART #	Fitment
ROH124-60	High Roof
ROH136-60	Standard Roof

### Roller Extension

- Adjustable 16" - 32"
- Adjustable riser for added support
- Material: Aluminum
- Color: Anodized black  
Anodized silver  
Powder coated white
- Roller only available in silver  
(see page 106 for dimensions)

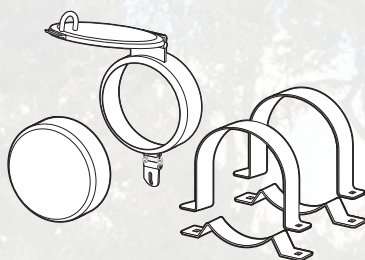

PART #
A40

- 6" Conduit Hatch & Cap
- No drilling required.
- Includes: Cross bar clamps
- Material: Aluminum
- Color: Anodized black  
Anodized silver  
Powder coated white

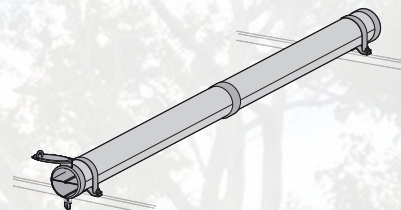

Part #	Description
CC-104	2 Compartment

### 6" x 128" Conduit Carrier Kit

- 3 or 4 compartments available (see page 110)
- Material: Aluminum
- Color: Anodized black  
Anodized silver  
Powder coated white
- Tube only available in silver

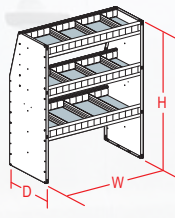
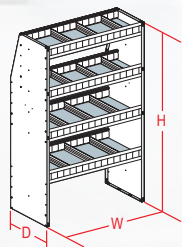

### Aluminum Interior Shelving

- Fitment: Nissan NV Cargo 2012-On
- Material: Aluminum
- Color: Silver

Height	Depth	Levels	Width 42"	Width 48"	Width 60"
48" Standard Roof	13"	3	SA4842-3	SA4848-3	SA4860-3
60" High Roof	13"	4	SA6042-4	SA6048-4	SA6060-4

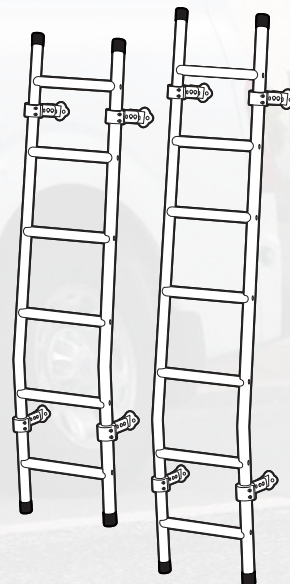

### Rear Access Ladder

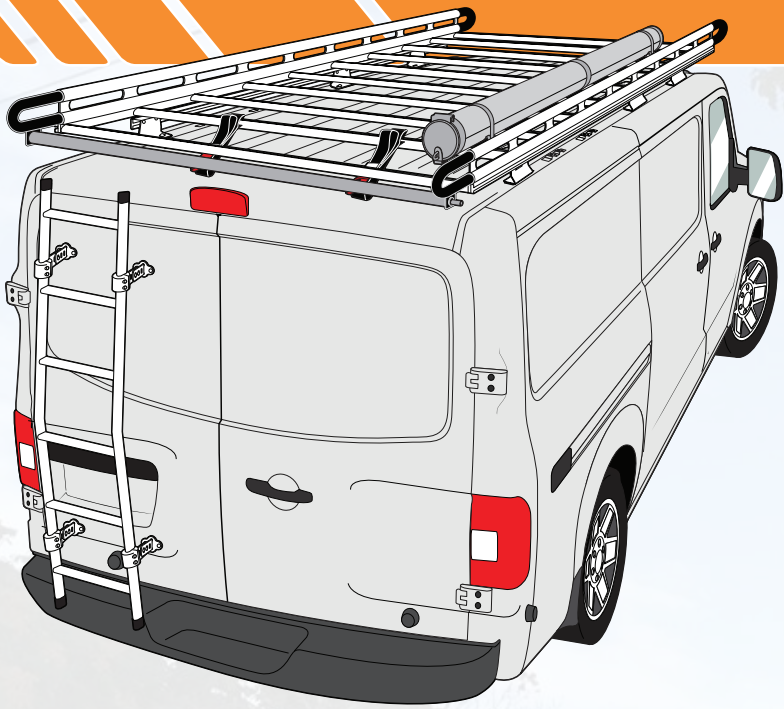

- Fitment: Nissan NV Cargo Van 2012-On
- Material: Aluminum
- Color: Anodized black  
Anodized silver  
Powder coated white

Height	Vehicles
68"	Standard Roof L003
83"	High Roof L004



## H2 RACK SYSTEM

- › Fastens onto existing factory mounting points
- › Fits standard and high roof
- › All aluminum design
- › Multiple cross bars at 16" apart
- › 2.25" x 1" x 65" cross bars
- › Built-in channels on the cargo rails and cross bars for additional accessories
- › Cargo rail lengths available in 120", 144" and 168"
- › Rear adjustable roller allows for easy loading and unloading
- › Roller can extend beyond the edge of the roof
- › Colors available: black, white or silver

H2 Rack System	Description	Cross Bar	Material	Color	Capacity	MSRP
	H2 120" Cargo System	65"	Aluminum	B / W / S	900 lbs.	H2301 (
	H2 144" Cargo System	65"	Aluminum	B / W / S	900 lbs.	H2302
	H2 168" Cargo System	65"	Aluminum	B / W / S	900 lbs.	H2303 (

## H2 Accessories



Part #

A20

### Adjustable Guide

- › Height: 5" tall
- › Fitment: Cross bars with channels
- › Material: Galvanized steel rubber dipped

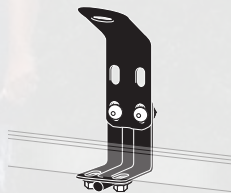

Part #

A57

### Ladder Stopper

- › Height: 5-7" tall
- › Material: Galvanized steel rubber dipped
- › Color: Black

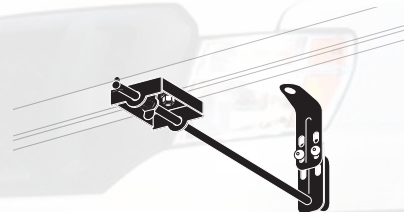

Part #

A64

### Push 2 Secure

- › Secure and lock ladder
- › Material: Galvanized steel rubber dipped
- › Color: Black

## H2 Accessories



**Part #**

A69

**EZ Hook and loop fastener Strap**

- ▶ Strap loops onto cross bar
- ▶ Capacity: 75 lbs.
- ▶ Fitment: All Vantech cross bars
- ▶ Material: Nylon
- ▶ Color: Black & red

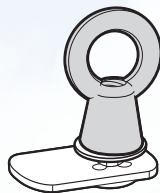

**Part #**

**Size**

A24

1"

A59

1.25"

**Eye hook**

- ▶ Fitment: Slides into aluminum channels
- ▶ Material: Stainless steel
- ▶ Color: Silver

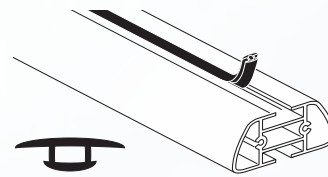

**Part #**

**Length**

BG-564

64"

**Rubber Bar Guard**

- ▶ Non-slip rubber surface
- ▶ Press-In installation method
- ▶ Fitment: A285 cross bars
- ▶ Material: Rubber
- ▶ Color: Black

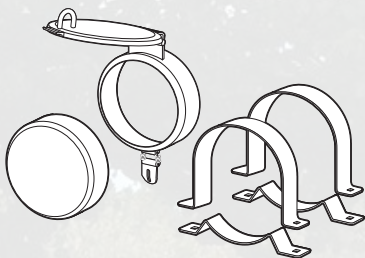

**PART #**

A34

**6" Conduit Carrier Hatch & Cap**

- ▶ No drilling required
- ▶ Secures to bars with sliders.
- ▶ Material: Aluminum
- ▶ Color: Anodized black  
Anodized silver  
Powder coated white

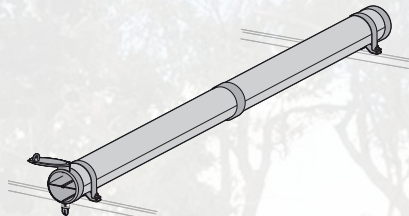

**Part #**

**Description**

CC-101

2 Compartment

**6" x 128" Conduit Carrier Kit**

- ▶ 3 or 4 compartments available (see page 110)
- ▶ Material: Aluminum
- ▶ Color: Anodized black  
Anodized silver  
Powder coated white
- ▶ Tube only available in silver

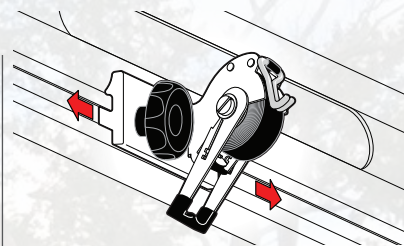

**Part #**

RTD10-H2

- ▶ **Ratchet Tie-Down**
- ▶ Bolt-on system (no drilling required)
- ▶ Self contained strap
- ▶ Strap: 1.5" x 120"
- ▶ Material: Stainless steel/Aluminum

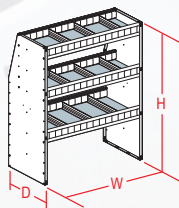
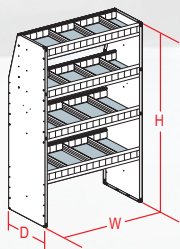

**Aluminum Interior Shelving**

- ▶ Fitment: Nissan NV Cargo 2012-On
- ▶ Material: Aluminum
- ▶ Color: Silver

Height	Depth	Levels	Width 42"	Width 48"	Width 60"
48" Standard Roof	13"	3	SA4842-3	SA4848-3	SA4860-3
60" High Roof	13"	4	SA6042-4	SA6048-4	SA6060-4

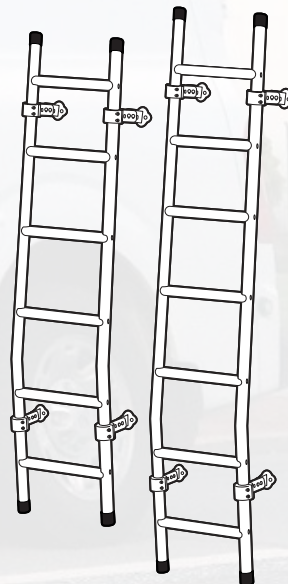

**Rear Access Ladder**

- ▶ Fitment: Nissan NV Cargo Van 2012-On
- ▶ Material: Aluminum
- ▶ Color: Anodized black  
Anodized silver  
Powder coated white

Height	Vehicles	
68"	Standard Roof	L003
83"	High Roof	L004

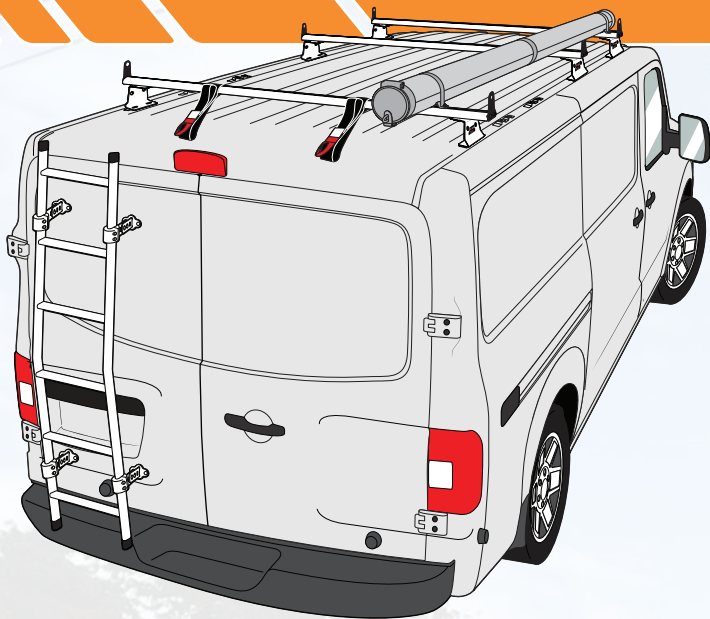

### H3 RACK SYSTEM

- › Fastens onto existing factory mounting points
- › Fits standard and high roof
- › All aluminum design
- › 6" wide mounting bases
- › Heavy duty 1/8" thick mounting bases
- › 3" x 1.5" x 65" cross bars
- › Built-in channels on the cross bars for additional accessories
- › 2 x .75" eyehooks per mounting base for easy tie down
- › Colors available: black, white or silver

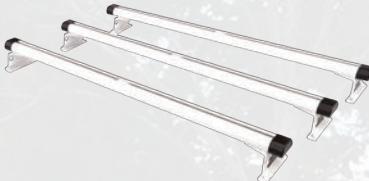
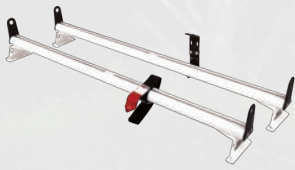
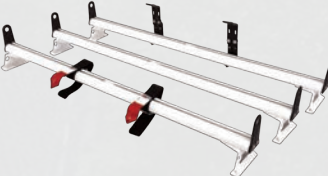
H3 Rack System	Description	Material	Color	Capacity	
	2 Bar System	Aluminum	B / W / S	500 lbs.	H3325
	3 Bar System	Aluminum	B / W / S	750 lbs.	H3326
	2 Bar System Included acc. 4 x Side Support 1 x Ladder Stopper 1 x Hook and loop fastener Strap	Aluminum	B / W / S	500 lbs.	H3321
	3 Bar System Included acc. 6 x Side Support 2 x Ladder Stopper 2 x Hook and loop fastener Strap	Aluminum	B / W / S	750 lbs.	H3322

### H3 Accessories

			
<b>Part #</b> A03	<b>Part #</b> A20	<b>Part #</b> A57	<b>Part #</b> A64
<b>Side Support</b> › Height : 4" tall from top of cross bar › Fitment: A286 cross bars › Material: Galvanized steel rubber dipped	<b>Adjustable Guide</b> › Height: 5" tall › Fitment: Cross bars with channels › Material: Galvanized steel rubber dipped	<b>Ladder Stopper</b> › Height: 5-7" tall › Material: Galvanized steel rubber dipped › Color: Black	<b>Push 2 Secure</b> › Secure and lock ladder › Material: Galvanized steel rubber dipped › Color: Black

## H3 Accessories

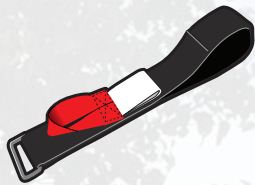

**Part #**

A69

**EZ Hook and loop fastener Strap**

- › Strap loops onto cross bar
- › Capacity: 75 lbs.
- › Fitment: All Vantech cross bars
- › Material: Nylon
- › Color: Black & red

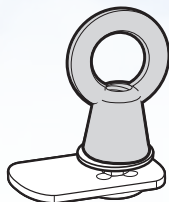

**Part # Size**

A24 1"

**1" Eye hook**

- › Fitment: Slides into aluminum channels
- › Material: Stainless steel
- › Color: Silver

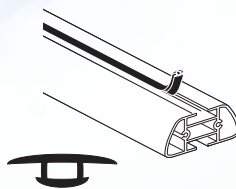

**Part # Length**

BG-565 65"

**Rubber Bar Guard**

- › Non-slip rubber surface
- › Press-In installation method
- › Fitment: A286 cross bars
- › Material: Rubber
- › Color: Black

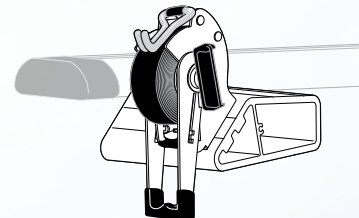

**Part #**

RTD10-H3

**› Ratchet Tie-Down**

- › Bolt-on system (no drilling required)
- › Self contained strap
- › Strap: 1.5" x 120"
- › Material: Stainless steel/Aluminum

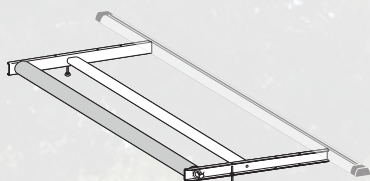

**PART # Fitment**

ROH322-50 Standard Roof

ROH334-50 High Roof

**Roller Extension**

- › Fitment: A286 cross bars
- › Material: Aluminum
- › Color: Anodized black  
Anodized silver  
Powder coated white
- › Roller only available in silver  
(See page 107 for dimensions)

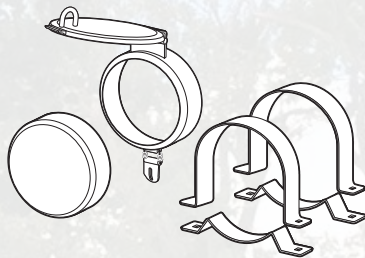

**PART #**

A34

**6" Conduit Hatch & Cap**

- › No drilling required
- › Secures to bars with sliders
- › Material: Aluminum
- › Color: Anodized black  
Anodized silver  
Powder coated white

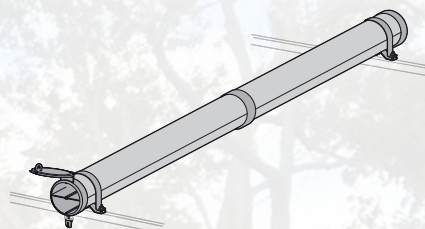

**Part # Description**

CC-101 2 Compartment

**6" x 128" Conduit Carrier Kit**

- › 3 or 4 compartments available (see page 110)
- › Material: Aluminum
- › Color: Anodized black  
Anodized silver  
Powder coated white
- › Tube only available in silver

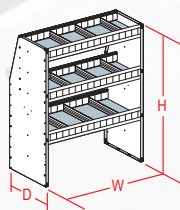
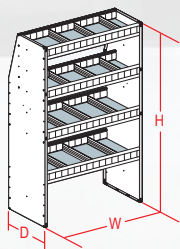

**Aluminum Interior Shelving**

- › Fitment: Nissan NV Cargo 2012-On
- › Material: Aluminum
- › Color: Silver

Height	Depth	Levels	Width 42"	Width 48"	Width 60"
48" Standard Roof	13"	3	SA4842-3	SA4848-3	SA4860-3
60" High Roof	13"	4	SA6042-4	SA6048-4	SA6060-4

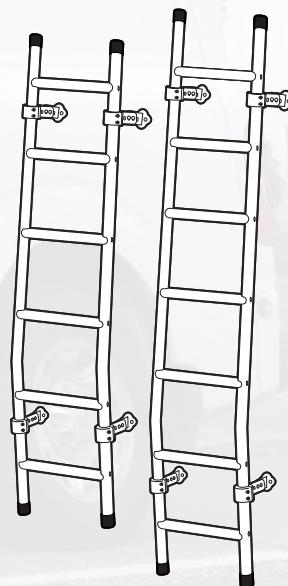

**Rear Access Ladder**

- › Fitment: Nissan NV Cargo Van 2012-On
- › Material: Aluminum
- › Color: Anodized black  
Anodized silver  
Powder coated white

Height	Vehicles	
68"	Standard Roof	L003
83"	High Roof	L004

## H1 RACK SYSTEM

- › Fastens onto existing factory tracks (if provided)  
Tracks available below part # R20 / R21
- › Fits low and high roof (all wheelbases)
- › 57" wide loading area (low roof)
- › 50" wide loading area (high roof)
- › 10" low profile mounting bases
- › 4 x .75" eyehooks per mounting base for easy tie down
- › Materials available: steel, aluminum or stainless steel
- › Colors available: black, white or silver

### STEEL SYSTEM

- › Heavy duty grade
- › Economical
- › Rust free
- › Stainless steel hardware
- › Lightweight



### STAINLESS STEEL SYSTEM

- › Rust free
- › Stainless steel hardware
- › Longer lasting durability

### ALUMINUM SYSTEM

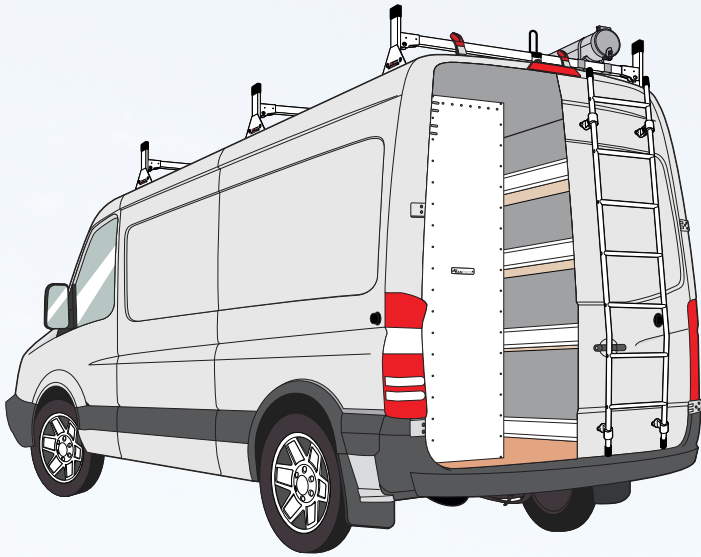
(more info see page 3)



H1 Rack System	Description	Material	Color	Capacity	Low Roof	High Roof
	2 Bar System	ST	B / W	500 lbs.	H2651	H2667
	Includes: 1 x Ladder Stopper 1 x Ladder Guide 1 x Hook and loop fastener Strap	AL	B / W / S	500 lbs.	H2641	H2665
		SS	SS	600 lbs.	H2637	H2647
	3 Bar System	ST	B / W	750 lbs.	H2652	H2668
	Includes: 2 x Ladder Stopper 2 x Ladder Guide 2 x Hook and loop fastener Strap	AL	B / W / S	750 lbs.	H2642	H2666
		SS	SS	900 lbs.	H2638	H2648

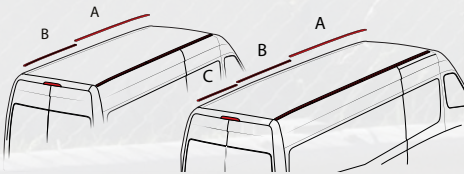

### Sprinter Track Kit

- › Fitment: Low roof sprinter  
High roof sprinter  
(see wheelbase)

Description	Length	Color
2 Piece Track (A,B)	144 Models	S R20
3 Piece Track (A,B,C)	170 Models	S R21

## H1 Accessories



- Part #**  
A69
- EZ Hook and loop fastener Strap**
- › Strap loops onto cross bar
  - › Capacity: 75 lbs.
  - › Fitment: All Vantech cross bars
  - › Material: Nylon
  - › Color: Black & red



- Part #**  
A02
- Ladder Guide**
- › Height: 5.5" tall
  - › Fitment: H series (1" x 2")
  - › Material: Galvanized steel
  - › Finish: Black rubber



- Part #**  
A06
- Ladder Stopper**
- › Height: 5" tall
  - › Fitment: H series (1" x 2")
  - › Material: Galvanized steel
  - › Finish: Black rubber

## H1 Accessories

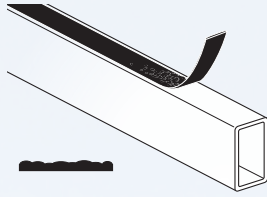

Part #	Length
BG-050	50"
BG-057	57"

### Plastic Bar Guard

- Textured plastic surface
- Adhesive backing
- Fitment: ST or SS cross bars
- Material: Plastic
- Color: Black

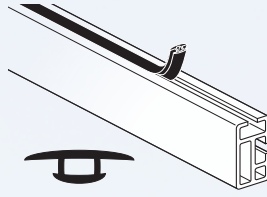

Part #	Length
BG-542	42"
BG-549	49"

### Rubber Bar Guard

- Non-slip rubber surface
- Press-In installation method
- Fitment: A613 cross bars
- Material: Rubber
- Color: Black

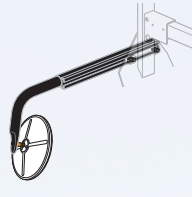

Part #	Adjustment
A81	25"-32"

### Back-Up 8" Convex Mirror

- Installs onto eye hooks
- Material: Aluminum
- Color: Anodized black

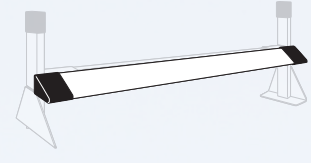

Part #	Fitment
WF-59	Low Roof
WF-52	High Roof

### Wind Foil

- Decreases wind noise and vibrations
- Does not interfere with accessories
- Material: Aluminum
- Color: Anodized black  
Powder coated white

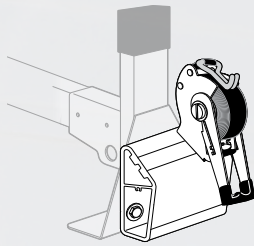

### Part #

RTD10-H1

- **Ratchet Tie-Down**
- Bolt-on system (no drilling required)
- Self contained strap
- Strap: 1.5" x 120"
- Material: Stainless steel

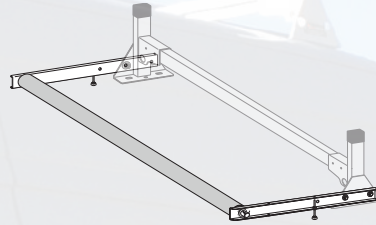

### PART # Roof

ROH124-58	Low Roof
ROH124-54	High Roof
ROH136-54	High Roof Ext.

### 24" Extension Roller

- Includes: Adjustable riser
- Material: Aluminum
- Color: Anodized black  
Anodized silver  
Powder coated white

- Roller only available in silver

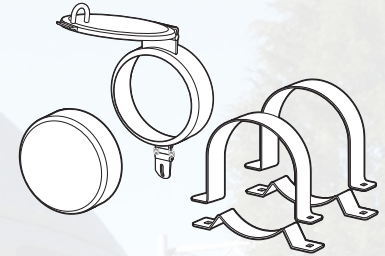

### PART #

A40

- **6" Conduit Hatch & Cap**
- No drilling required.
- Includes: Cross bar clamps
- Material: Aluminum
- Color: Anodized black  
Anodized silver  
Powder coated white

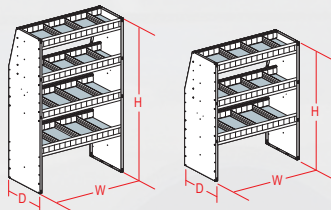

Height	Depth	Levels	Width 42"	Width 48"	Width 60"
48" Low Roof	13"	3	SA4842-3	SA4848-3	SA4860-3
60" High Roof	13"	4	SA6042-4	SA6048-4	SA6060-4

### Aluminum Interior Shelving

- Material: Aluminum
- Color: Silver

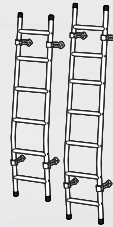

Height	Vehicles	Part #
68"	Low Roof	L003
83"	High Roof	L004

### Rear Access Ladder

- Fitment: Sprinter 2007-On
- Material: Aluminum
- Color: Anodized black  
Anodized silver  
Powder coated white

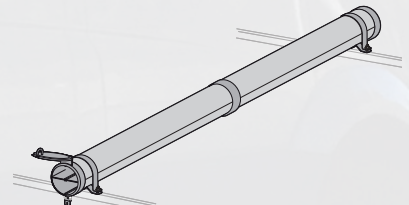

### Part # Description

CC-104 2 Compartment

### 6" x 128" Conduit Carrier Kit



- 3 or 4 compartments available (see page 110)
- Material: Aluminum
- Color: Anodized black  
Anodized silver  
Powder coated white
- Tube only available in silver

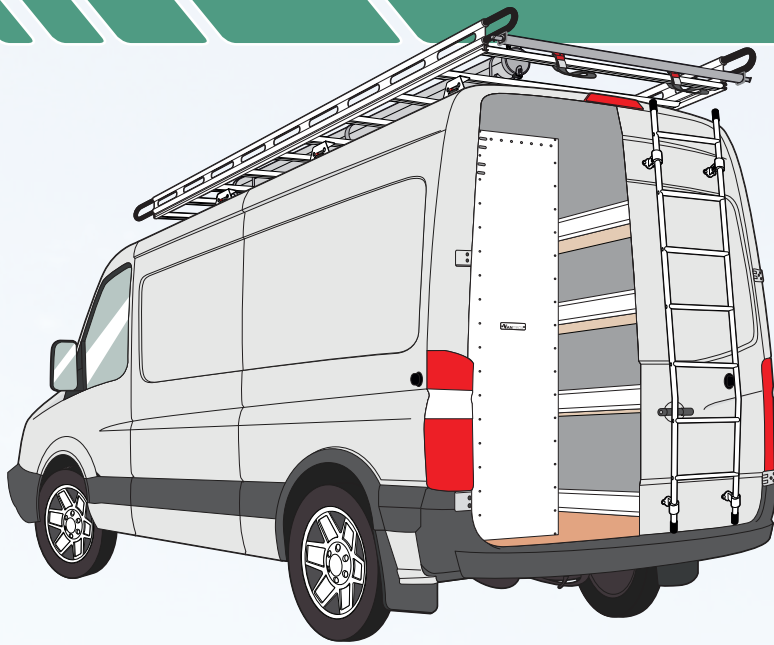



## H2 RACK SYSTEM

- › Fastens onto existing factory tracks (if provided)  
Tracks available below part # R20 / R21
- › Fits low and high roof (all wheelbases)
- › All aluminum design
- › Multiple cross bars at 16" apart
- › 2.25" x 1" x 65" cross bars
- › Built-in channels on the cargo rails and cross bars for additional accessories
- › Cargo rail lengths available in 120", 144" and 168"
- › Rear adjustable roller allows for easy loading and unloading
- › Roller can extend beyond the edge of the roof
- › Colors available: black, white or silver

H2 Rack System	Description	Cross bar	Fitment	Material	Color	Capacity	
	H2 120" Cargo System	65"	Low Roof	Aluminum	B / W / S	900 lbs.	H2461
		60"	High Roof	Aluminum	B / W / S	900 lbs.	H2456
	H2 144" Cargo System	65"	Low Roof	Aluminum	B / W / S	900 lbs.	H2462
		60"	High Roof	Aluminum	B / W / S	900 lbs.	H2457
	H2 168" Cargo System	65"	Low Roof	Aluminum	B / W / S	900 lbs.	H2463
		60"	High Roof	Aluminum	B / W / S	900 lbs.	H2458

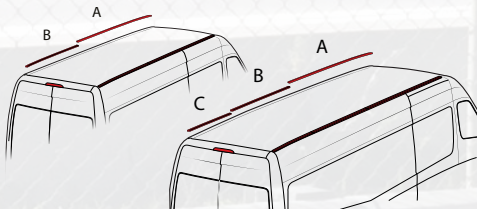

### Sprinter Track Kit

- › Fitment: Low roof sprinter  
High roof sprinter  
(see wheelbase)

Description	Length	Color	
2 Piece Track (A,B)	144 Models	S	R20
3 Piece Track (A,B,C)	170 Models	S	R21

## H2 Accessories

**Part #**  
A69

**EZ Hook and loop fastener Strap**

- › Strap loops onto cross bar
- › Capacity: 75 lbs.
- › Fitment: All Vantech cross bars
- › Material: Nylon
- › Color: Black & red



**Part #**  
A57

**Ladder Stopper**

- › Height: 5-7" tall
- › Material: Galvanized steel  
rubber dipped
- › Color: Black



**Part #**    **Size**

A24    1"

A59    1.25"

**1" Eye hook**

- › Fitment: Slides into aluminum channels
- › Material: Stainless steel
- › Color: Silver



## H2 Accessories

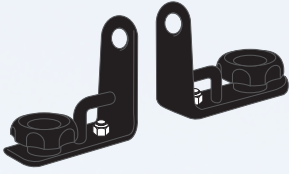

**Part #**

A20

**Adjustable Guide**

- › Height: 5" tall
- › Fitment: cross bars with channels
- › Material: Galvanized steel rubber dipped

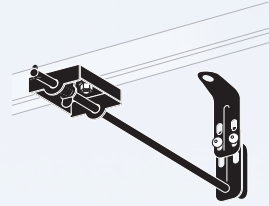

**Part #**

A64

**Push 2 Secure**

- › Secure & Lock Ladder
- › Material: Galvanized steel rubber dipped
- › Color: Black

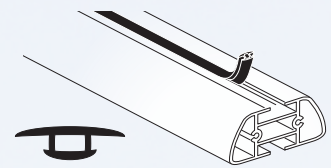

**Part # Length**

BG-554	54"
BG-564	64"

**Rubber Bar Guard**

- › Non-slip rubber surface
- › Press-In installation method
- › Fitment: A285 cross bars
- › Material: Rubber
- › Color: Black

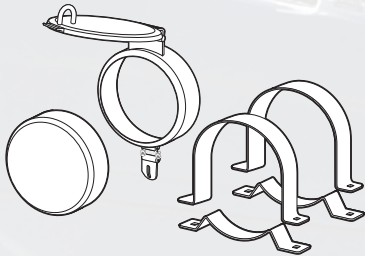

**PART #**

A34

**6" Conduit Carrier Hatch & Cap**

- › No drilling required
- › Secures to bars with sliders.
- › Material: Aluminum
- › Color: Anodized black  
Anodized silver  
Powder coated white

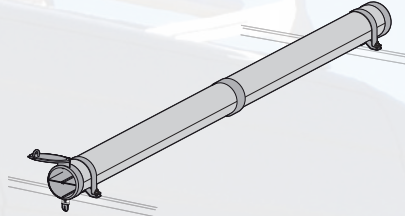

**Part # Description**

CC-101 2 Compartment

**6" x 128" Conduit Carrier Kit**

- › 3 or 4 compartments available (see page 110)
- › Material: Aluminum
- › Color: Anodized black  
Anodized silver  
Powder coated white
- › Tube only available in silver

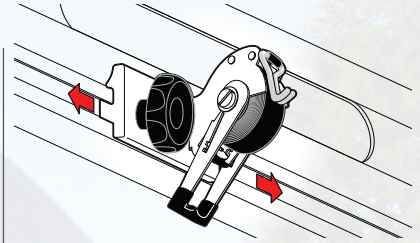

**Part #**

RTD10-H2

- › Ratchet Tie-Down
- › Bolt-on system (no drilling required)
- › Self contained strap
- › Strap: 1.5" x 120"
- › Material: Stainless steel/Aluminum

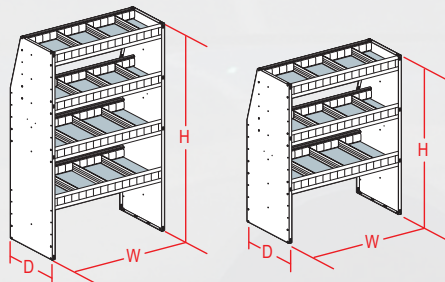

**Aluminum Interior Shelving**

- › Material: Aluminum
- › Color: Silver

Height	Depth	Levels	Width 42"	Width 48"	Width 60"
48" Low Roof	13"	3	SA4842-3	SA4848-3	SA4860-3
60" High Roof	13"	4	SA6042-4	SA6048-4	SA6060-4

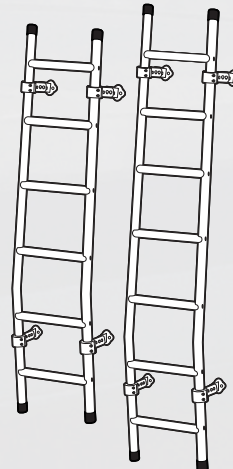

**Rear Access Ladder**



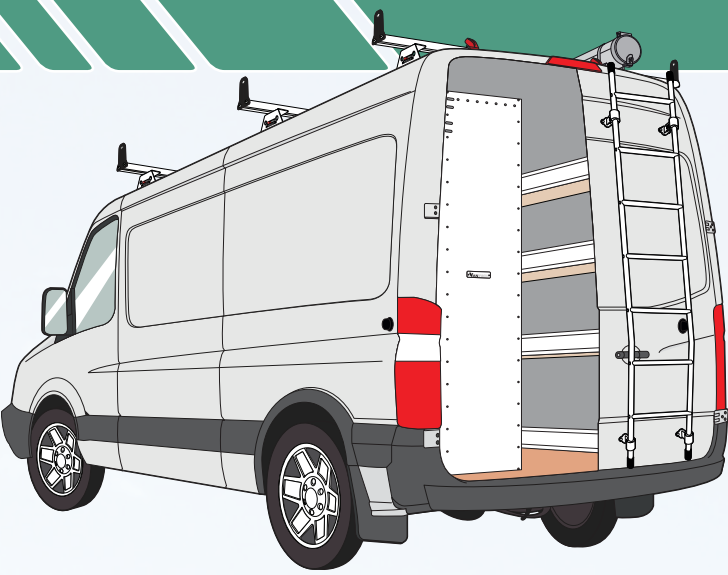

- › Fitment: Sprinter 2007-On
- › Material: Aluminum
- › Color: Anodized black  
Anodized silver  
Powder coated white

Height	Vehicles	
68"	Low Roof	L003
83"	High Roof	L004



### H3 RACK SYSTEM

- › Fastens onto existing factory tracks (if provided)  
Tracks available below part # R20 / R21
- › Fits low and high roof (all wheelbases)
- › All aluminum design
- › 6" wide mounting bases
- › Heavy duty 1/8" thick mounting bases
- › 3" x 1.5" x 65" cross bars
- › Built-in channels on the cross bars for additional accessories
- › 2 x .75" eyehooks per mounting base for easy tie down
- › Colors available: black, white or silver

H3 Rack System	Description	Material	Color	Weight Capacity
	2 Bar System	Aluminum	B / W / S	500 lbs.
	3 Bar System	Aluminum	B / W / S	750 lbs.
	2 Bar System Included acc. 4 x Side Support 1 x Ladder Stopper 1 x Hook and loop fastener Strap	Aluminum	B / W / S	500 lbs.
	3 Bar System Included acc. 6 x Side Support 2 x Ladder Stopper 2 x Hook and loop fastener Strap	Aluminum	B / W / S	750 lbs.

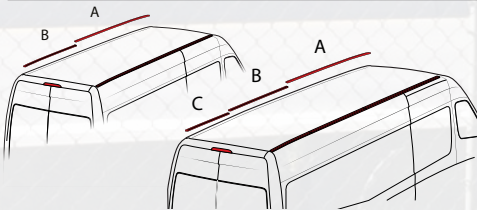

### Sprinter Track Kit

- › Fitment: Low roof sprinter  
High roof sprinter  
(see wheelbase)

Description	Length	Color
2 Piece Track (A,B)	144 Models	S
3 Piece Track (A,B,C)	170 Models	S

### H3 Accessories



Part #

A03

#### Side Support

- › Height: 4" tall from top of cross bar
- › Fitment: A286 cross bars
- › Material: Galvanized steel rubber dipped



Part #

A20

#### Adjustable Guide

- › Height: 5" tall
- › Fitment: Cross bars with channels
- › Material: Galvanized steel rubber dipped

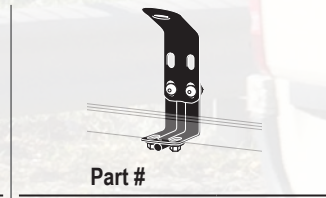

Part #

A57

#### Ladder Stopper

- › Height: 5-7" tall
- › Material: Galvanized steel rubber dipped
- › Color: Black

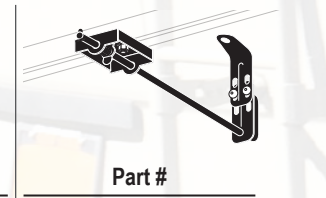

Part #

A64

#### Push 2 Secure

- › Secure and lock ladder
- › Material: Galvanized steel rubber dipped
- › Color: Black

## H3 Accessories

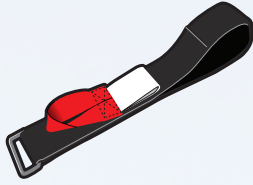

**Part #**

A69

**EZ Hook and loop fastener Strap**

- › Strap loops onto cross bar
- › Capacity: 75 lbs.
- › Fitment: All Vantech cross bars
- › Material: Nylon
- › Color: Black & red

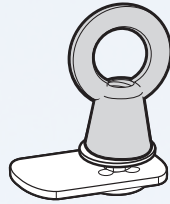

**Part # Size**

A24 1"  
A59 1.25"

**1" Eye hook**

- › Fitment: Slides into aluminum channels
- › Material: Stainless steel
- › Color: Silver

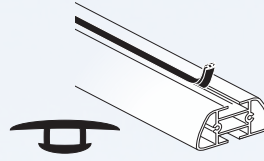

**Part # Length**

BG-565 65"

**Rubber Bar Guard**

- › Non-slip rubber surface
- › Press-In installation method
- › Fitment: A286 cross bars
- › Material: Rubber
- › Color: Black

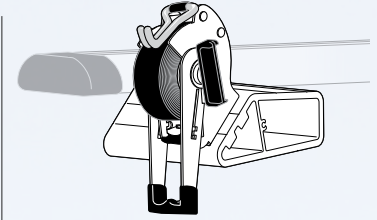

**Part #**

RTD10-H3

**› Ratchet Tie-Down**

- › Bolt-on system (no drilling required)
- › Self contained strap
- › Strap: 1.5" x 120"
- › Material: Stainless steel/Aluminum

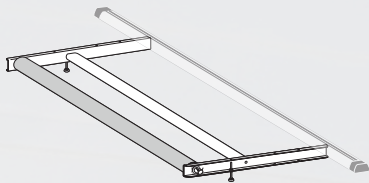

**PART # Fitment**

ROH324-50 Low / High Roof  
ROH336-50 Low / High Roof EXT

**Roller Extension**

- › Fitment: A286 cross bars
- › Material: Aluminum
- › Color: Anodized black  
Anodized silver  
Powder coated white
- › Roller only available in silver

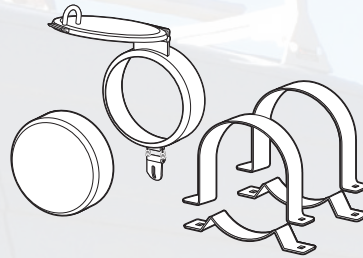

**PART #**

A34

**6" Conduit Hatch & Cap**

- › No drilling required
- › Secures to bars with sliders
- › Material: Aluminum
- › Color: Anodized black  
Anodized silver  
Powder coated white

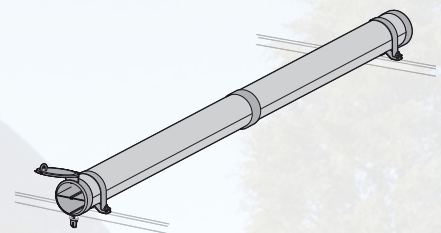

**Part # Description**

CC-101 2 Compartment

**6" x 128" Conduit Carrier Kit**

- › 3 or 4 compartments available (see page 110)
- › Material: Aluminum
- › Color: Anodized black  
Anodized silver  
Powder coated white
- › Tube only available in silver

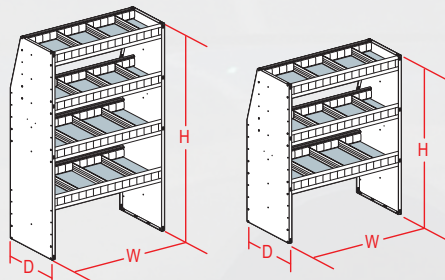

**Aluminum Interior Shelving**

- › Material: Aluminum
- › Color: Silver

Height	Depth	Levels	Width 42"	Width 48"	Width 60"
48" Low Roof	13"	3	SA4842-3	SA4848-3	SA4860-3
60" High Roof	13"	4	SA6042-4	SA6048-4	SA6060-4

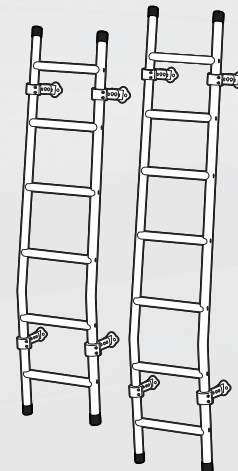

**Rear Access Ladder**

- › Fitment: Sprinter 2007-On
- › Material: Aluminum
- › Color: Anodized black  
Anodized silver  
Powder coated white

**Height Vehicles**

68" Low Roof  
83" High Roof

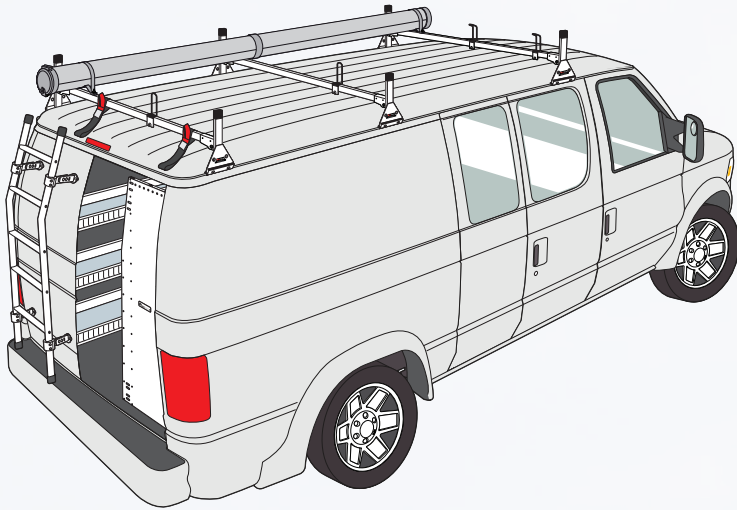

## H1 RACK SYSTEM

- › Clamps onto factory drip rails
- › Vehicle specific fitment
- › No drilling necessary
- › 16" standard mounting bases
- › 4 x .75" eyehooks per mounting base for easy tie down
- › Materials available: steel, aluminum or stainless steel
- › Colors available: black, white or silver

### STEEL SYSTEM

- › Heavy duty grade
- › Economical



### STAINLESS STEEL SYSTEM

- › Rust free
- › Stainless steel hardware
- › Longer lasting durability

### ALUMINUM SYSTEM

- › Rust free
- › Stainless steel hardware
- › Lightweight

(more info see page 3)

H1 Rack System	Description	Fitment	ST	AL	SS	
	2 Bar System	Chevy Express 1996-On	H1022	H3022	H4015	
	Includes: 1 x Ladder Stopper 1 x Ladder Guide 1 x Hook and loop fastener Strap	GMC Savana 1996-On	H1052	H3052	H4030	
		Dodge Ram 1981-07	H1062	H3062	H4035	
		Ford Econoline 1992-13	H1082	H3082	H4045	
		Chevy Express 1996-On	H1023	H3023	H4160	
	3 Bar System	GMC Savana 1996-On	H1053	H3053	H4175	
	Includes: 2 x Ladder Stopper 2 x Ladder Guide 2 x Hook and loop fastener Strap	Dodge Ram 1981-07	H1063	H3063	H4180	
		Ford Econoline 1992-13	H1083	H3083	H4190	
		Chevy Express 1996-On	H1024	H3024	H4161	
		GMC Savana 1996-On	H1054	H3054	H4176	
	4 Bar System	Dodge Ram 1981-07	H1064	H3064	H4181	
	Includes: 2 x Ladder Stopper 2 x Ladder Guide 2 x Hook and loop fastener Strap	Ford Econoline 1992-13	H1084	H3084	H4191	
		› Dodge Sprinter 2002-06 available online				

## H1 Accessories

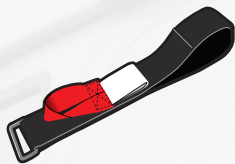

Part #

A69

### EZ Hook and loop fastener Strap

- › Strap loops onto cross bar
- › Capacity: 75 lbs.
- › Fitment: All Vantech cross bars
- › Material: Nylon
- › Color: Black & red



Part #

A02

### Ladder Guide

- › Height: 5.5" tall
- › Fitment: H series (1" x 2")
- › Material: Galvanized steel
- › Finish: Black rubber



Part #

A06

### Ladder Stopper

- › Height: 5" tall
- › Fitment: H series (1" x 2")
- › Material: Galvanized steel
- › Finish: Black rubber

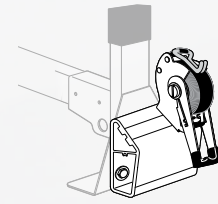

Part #

RTD10-H1

### › Ratchet Tie-Down

- › Bolt-on system (no drilling required)
- › Self contained strap
- › Strap: 1.5" x 120"
- › Material: Stainless steel/Aluminum

## H1 Accessories

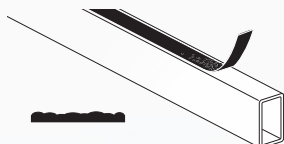

Part #	Length
BG-056	56"
BG-057	57"
BG-062	62"
BG-063	63"

### Plastic Bar Guard

- Textured plastic surface
- Adhesive backing
- Fitment: ST or SS cross bars
- Material: Plastic
- Color: Black



Part #	Length
BG-548	48"
BG-549	49"
BG-554	54"
BG-555	55"

### Rubber Bar Guard

- Non-slip rubber surface
- Press-In installation method
- Fitment: A613 cross bars
- Material: Rubber
- Color: Black

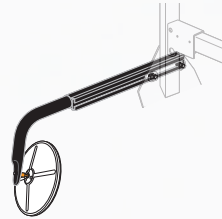

Part #	Adjustment
A81	25"-32"

### Back-Up 8" Convex

- Installs onto eye hooks
- Material: Aluminum
- Color: Anodized black  
Powder coated white

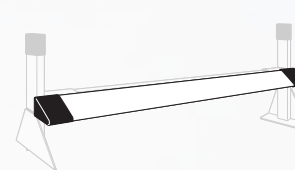

Part #	Fitment
WF-59	Chevy / GMC
WF-65	Dodge / Ford

### Wind Foil

- Decreases wind noise and vibrations
- Does not interfere with accessories
- Material: Aluminum
- Color: Anodized black  
Powder coated white

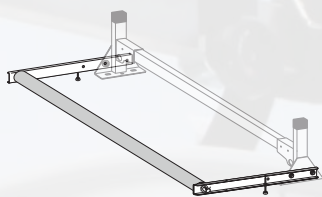

PART #	Fitment
ROH124-57	Chevy / GMC
ROH124-63	Dodge / Ford

### 24" Extension Roller

- Adjustable riser for added support
- Material: Aluminum
- Color: Anodized black  
Anodized silver  
Powder coated white
- Roller only available in silver

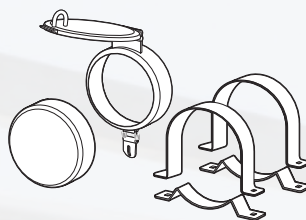

PART #
A40

- 6" Conduit Hatch & Cap
- No drilling required.
- Includes: Cross bar clamps
- Material: Aluminum
- Color: Anodized black  
Anodized silver  
Powder coated white

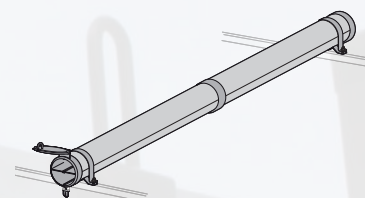

Part #	Description
CC-104	2 Compartment

### 6" x 128" long Conduit Carrier Kit

- 3 or 4 compartments available (see page 110)
- Material: Aluminum
- Color: Anodized black  
Anodized silver  
Powder coated white
- Tube only available in silver

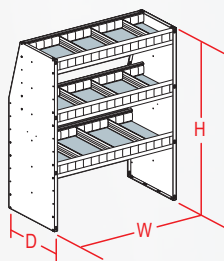

### Aluminum Interior Shelving

- Fitment: Fullsize vans
- Material: Aluminum
- Color: Silver

Height	Depth	Levels	Width 42"	Width 48"	Width 60"	Width 72"	Width 84"	Width 96"
48" Standard Roof	13"	3	SA4842-3	SA4848-3	SA4860-3	SA4872-3	SA4884-3	SA4896-3

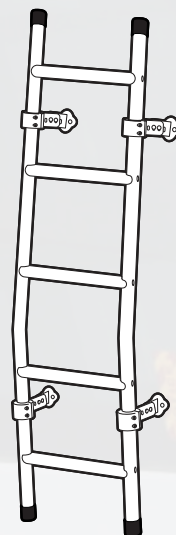

### Height

56"

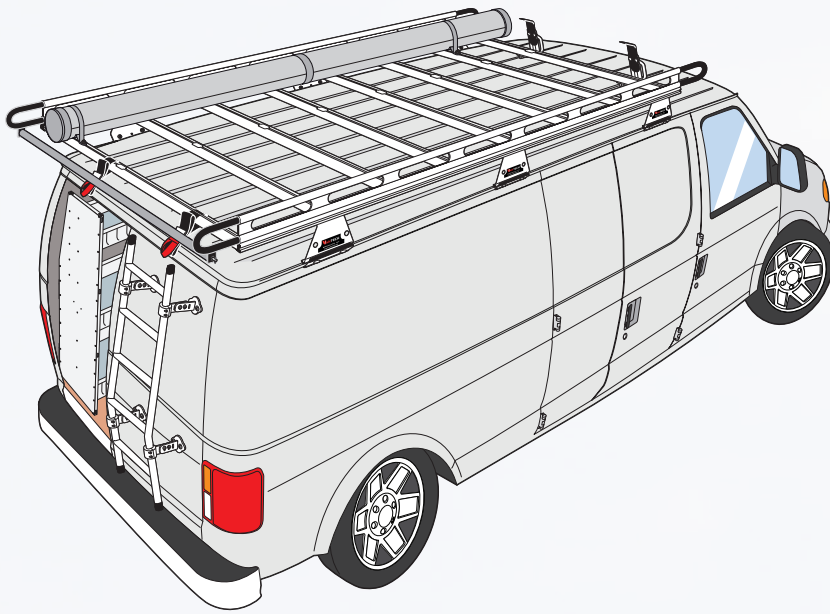

### Rear Access Ladder

- Fitment: Dodge van all years,  
Ford Econoline all years,  
Chevy/GMC 96 and up  
w/o rear windows
- Material: Aluminum
- Color: Anodized black  
Anodized silver  
Powder coated white



## H2 RACK SYSTEM

- › Clamps onto factory drip rails
- › Vehicle specific fitment
- › All aluminum design
- › Multiple cross bars at 16" apart
- › 2.25" x 1" cross bars
- › Built-in channels on the cargo rails and cross bars for additional accessories
- › Cargo rail lengths available in 120", 144" and 168"
- › Rear adjustable roller allows for easy loading and unloading
- › Roller can extend beyond the edge of the roof
- › Colors available: black, white or silver

H2 Rack System	Description	Cross Bar	Fitment	Color	Capacity
	H2 120" Cargo System	65"	Chevy Express 1996-On	B / W / S	900 lbs.
			GMC Savana 1996-On	B / W / S	900 lbs.
			Dodge Ram 1981-07	B / W / S	900 lbs.
			Ford Econoline 1992-13	B / W / S	900 lbs.
	H2 144" Cargo System	65"	Chevy Express 1996-On	B / W / S	900 lbs.
			GMC Savana 1996-On	B / W / S	900 lbs.
			Dodge Ram 1981-07	B / W / S	900 lbs.
			Ford Econoline 1992-13	B / W / S	900 lbs.
	H2 168" Cargo System	65"	Chevy Express 1996-On	B / W / S	900 lbs.
			GMC Savana 1996-On	B / W / S	900 lbs.
			Dodge Ram 1981-07	B / W / S	900 lbs.
			Ford Econoline 1992-13	B / W / S	900 lbs.

## H2 Accessories



**Part #**

A20

### Adjustable Guide

- › Height: 5" tall
- › Fitment: Cross bars with channels
- › Material: Galvanized steel rubber dipped

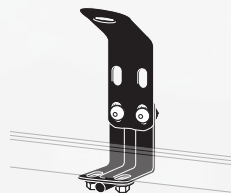

**Part #**

A57

### Ladder Stopper

- › Height: 5-7" tall
- › Material: Galvanized steel rubber dipped
- › Color: Black

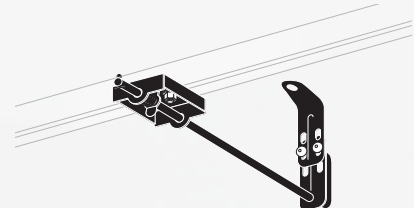

**Part #**

A64

### Push 2 Secure

- › Secure and lock ladder
- › Material: Galvanized steel rubber dipped
- › Color: Black

## H2 Accessories

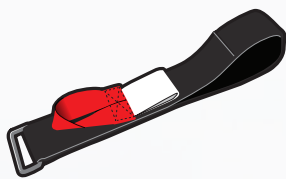

Part #
A69

### EZ Hook and loop fastener Strap

- › Strap loops onto cross bar
- › Capacity: 75 lbs.
- › Fitment: All Vantech cross bars
- › Material: Nylon
- › Color: Black & red

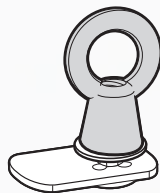

Part #	Size
A24	1"
A59	1.25"

### Eye hook

- › Fitment: Slides into aluminum channels
- › Material: Stainless steel
- › Color: Silver



Part #	Length
BG-564	64"

### Rubber Bar Guard

- › Non-slip rubber surface
- › Press-In installation method
- › Fitment: A285 cross bars
- › Material: Rubber
- › Color: Black

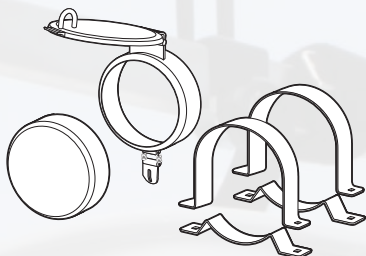

PART #
A34

### 6" Conduit Carrier Hatch & Cap

- › No drilling required
- › Secures to bars with sliders.
- › Material: Aluminum
- › Color: Anodized black  
Anodized silver  
Powder coated white

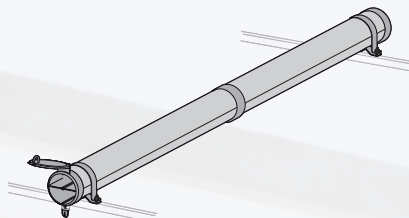

Part #	Description
CC-101	2 Compartment

### 6" x 128" Conduit Carrier Kit

- › 3 or 4 compartments available (see page 110)
- › Material: Aluminum
- › Color: Anodized black  
Anodized silver  
Powder coated white
- › Tube only available in silver

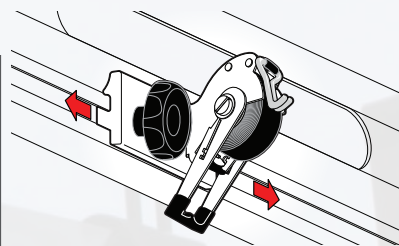

Part #
RTD10-H2

- › Ratchet Tie-Down
- › Bolt-on system (no drilling required)
- › Self contained strap
- › Strap: 1.5" x 120"
- › Material: Stainless steel/Aluminum

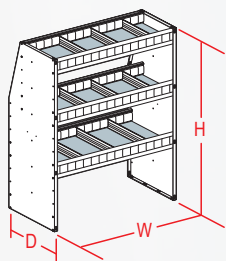

### Aluminum Interior Shelving

- › Fitment: Fullsize vans
- › Material: Aluminum
- › Color: Silver

Height	Depth	Levels	Width 42"	Width 48"	Width 60"	Width 72"	Width 84"	Width 96"
48" Standard Roof	13"	3	SA4842-3	SA4848-3	SA4860-3	SA4872-3	SA4884-3	SA4896-3

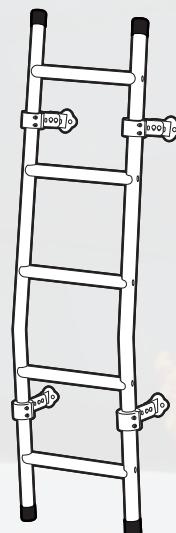

Height
56"

### Rear Access Ladder



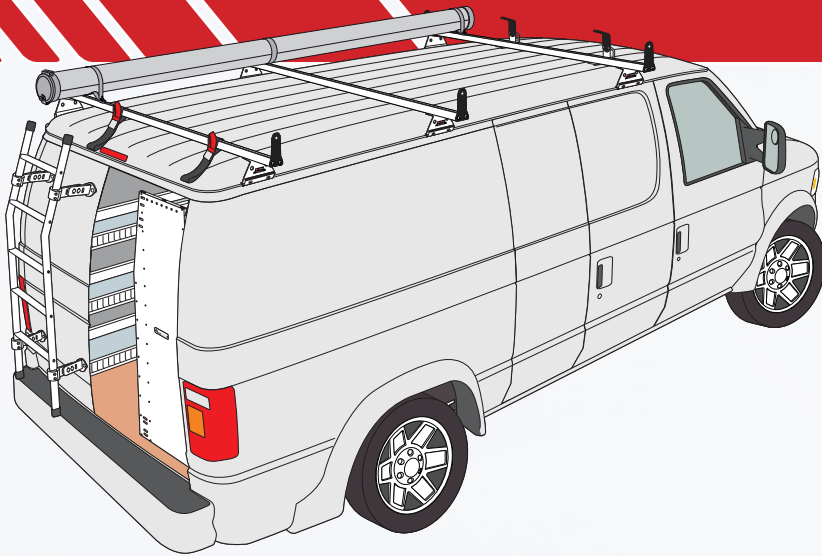

- › Fitment: Dodge van all years, Ford Econoline all years, Chevy/GMC 96 and up w/o rear windows
- › Material: Aluminum
- › Color: Anodized black  
Anodized silver  
Powder coated white



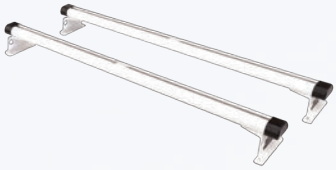

### H3 RACK SYSTEM

- › Clamps onto factory drip rails
- › Vehicle specific fitment
- › All aluminum design
- › 8" wide mounting bases
- › Heavy duty 1/8" thick mounting bases
- › 3" x 1.5" cross bars
- › Built-in channels on the cross bars for additional accessories
- › 2 x .75" eyehooks per mounting base for easy tie down
- › Colors available: black, white or silver

H3 Rack System	Description	Fitment	Cross Bar	Color	Capacity
	2 Bar System	Chevy Express 1996-On	65"	B / W / S	500 lbs.
		GMC Savana 1996-On	65"	B / W / S	500 lbs.
		Dodge Ram 1981-07	72"	B / W / S	500 lbs.
		Ford Econoline 1992-13	72"	B / W / S	500 lbs.
	3 Bar System	Chevy Express 1996-On	65"	B / W / S	750 lbs.
		GMC Savana 1996-On	65"	B / W / S	750 lbs.
		Dodge Ram 1981-07	72"	B / W / S	750 lbs.
		Ford Econoline 1992-13	72"	B / W / S	750 lbs.
	2 Bar System Included acc. 4 x Side Supports 1 x Ladder Stopper 1 x Hook and loop fastener Strap	Chevy Express 1996-On	65"	B / W / S	500 lbs.
		GMC Savana 1996-On	65"	B / W / S	500 lbs.
		Dodge Ram 1981-07	72"	B / W / S	500 lbs.
		Ford Econoline 1992-13	72"	B / W / S	500 lbs.
	3 Bar System Included acc. 6 x Side Supports 2 x Ladder Stopper 2 x Hook and loop fastener Strap	Chevy Express 1996-On	65"	B / W / S	750 lbs.
		GMC Savana 1996-On	65"	B / W / S	750 lbs.
		Dodge Ram 1981-07	72"	B / W / S	750 lbs.
		Ford Econoline 1992-13	72"	B / W / S	750 lbs.

### H3 Accessories

			
<b>Part #</b>	<b>Part #</b>	<b>Part #</b>	<b>Part #</b>
A03	A20	A57	A64
<b>Side Support</b>	<b>Adjustable Guide</b>	<b>Ladder Stopper</b>	<b>Push 2 Secure</b>
› Height : 4" tall from top of cross bar	› Height: 5" tall	› Height: 5-7" tall	› Secure and lock ladder
› Fitment: A286 cross bars	› Fitment: Cross bars with channels	› Material: Galvanized steel rubber dipped	› Material: Galvanized steel rubber dipped
› Material: Galvanized steel rubber dipped	› Material: Galvanized steel rubber dipped	› Color: Black	› Color: Black

## H3 Accessories

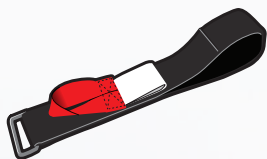

**Part #**

A69

**EZ Hook and loop fastener Strap**

- › Strap loops onto cross bar
- › Capacity: 75 lbs.
- › Fitment: All Vantech cross bars
- › Material: Nylon
- › Color: Black & red

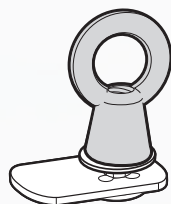

**Part # Size**

A24 1"

A59 1.25"

**1" Eye hook**

- › Fitment: Slides into aluminum channels
- › Material: Stainless steel
- › Color: Silver

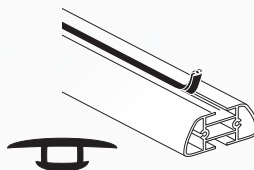

**Part # Length**

BG-565 65"

BG-572 72"

**Rubber Bar Guard**

- › Non-slip rubber surface
- › Press-In installation method
- › Fitment: A286 cross bars
- › Material: Rubber
- › Color: Black

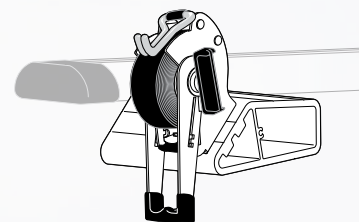

**Part #**

RTD10-H3

**Ratchet Tie-Down**

- › Bolt-on system (no drilling required)
- › Self contained strap
- › Strap: 1.5" x 120"
- › Material: Stainless steel/Aluminum

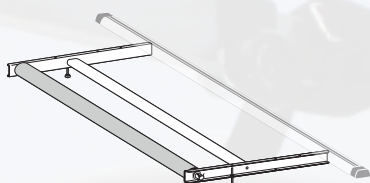

**PART #**

ROH324-50

**Roller Extension**

- › Adjustable 10" or 20"
- › Fitment: A286 cross bars
- › Material: Aluminum
- › Color: Anodized black  
Anodized silver  
Powder coated white
- › Roller only available in silver

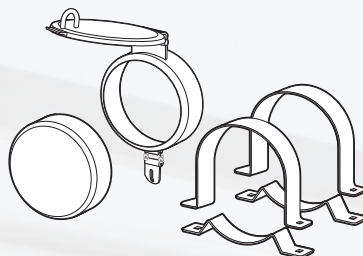

**PART #**

A34

**6" Conduit Hatch & Cap**

- › No drilling required
- › Secures to bars with sliders
- › Material: Aluminum
- › Color: Anodized black  
Anodized silver  
Powder coated white

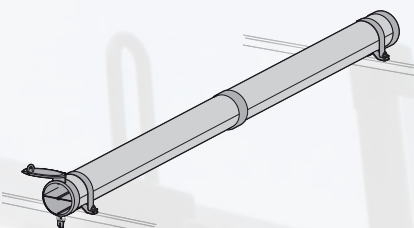

**Part # Description**

CC-101 2 Compartment

**6" x 128" Conduit Carrier Kit**

- › 3 or 4 compartments available (see page 110)
- › Material: Aluminum
- › Color: Anodized black  
Anodized silver  
Powder coated white
- › Tube only available in silver

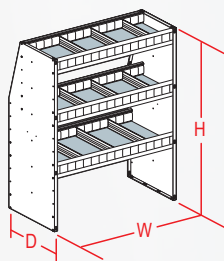

**Aluminum Interior Shelving**

- › Fitment: Fullsize vans
- › Material: Aluminum
- › Color: Silver

Height	Depth	Levels	Width 42"	Width 48"	Width 60"	Width 72"	Width 84"	Width 96"
48" Standard Roof	13"	3	SA4842-3	SA4848-3	SA4860-3	SA4872-3	SA4884-3	SA4896-3

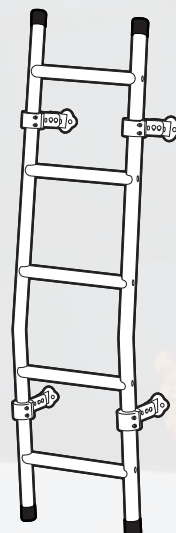

**Height**

56"

**Rear Access Ladder**

- › Fitment: Dodge van all years, Ford Econoline all years, Chevy/GMC 96 and up w/o rear windows
- › Material: Aluminum
- › Color: Anodized black  
Anodized silver  
Powder coated white



## H1 CUSTOM RACK SYSTEM

- › Clamps onto factory drip rails
- › Customized upright height clearance (drilling required)
- › Addition of cross bars can increase load bearing capacity
- › 28.5" total post height mounting base
- › 4 x .75" eyehooks per mounting base for easy tie down
- › Colors available: black or white
- › 2 bar roof top clearance 3" - 10" max load capacity 450lbs
- › 2 bar roof top clearance 11" - 14" max load capacity 400lbs
- › 2 bar roof top clearance 15" - 18" max load capacity 350lbs
- › 2 bar roof top clearance 19" - 22" max load capacity 300lbs
- › 2 bar roof top clearance 23" - 23.5" max load capacity 250lbs
- › Materials available: steel or aluminum

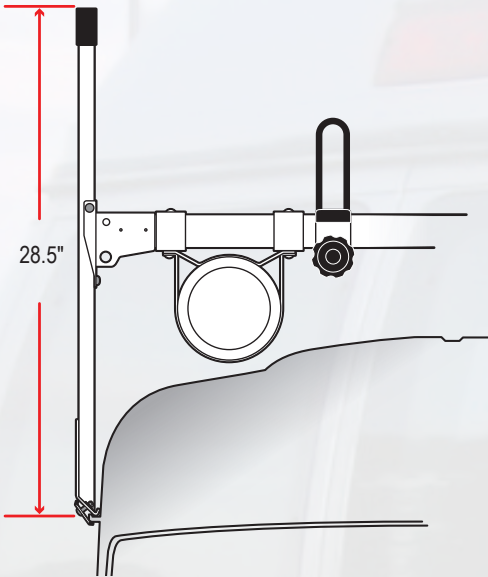

### STEEL SYSTEM

- › Heavy duty grade
- › Economical

### ALUMINUM SYSTEM

- › Rust free
- › Stainless steel hardware
- › Lightweight

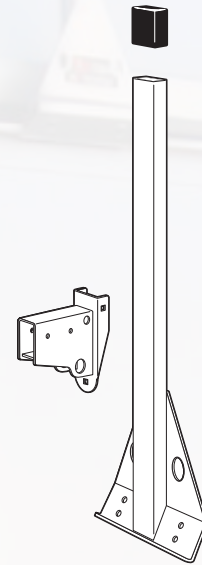

(more info see page 3)

H1 Rack System

Description

Bar Length

Height

ST

AL

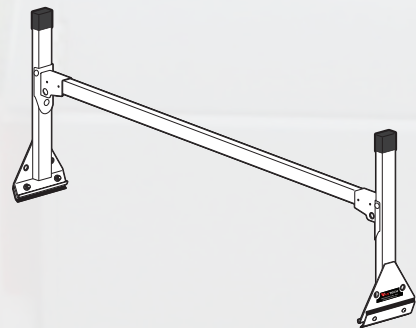

1 Bar system custom  
(Unassembled)  
Accessories not included

57" Cross Bar

3"-23.5"

H1802

H1808

63" Cross Bar

3"-23.5"

H1803 (

H1809

72" Cross Bar

3"-23.5"

H1804

H1810

## H1 Accessories°



### Part #

A02

#### Ladder Guide

- › Height: 5.5" tall
- › Fitment: H series (1" x 2")
- › Material: Galvanized steel
- › Finish: Black rubber



### Part #

A06

#### Ladder Stopper

- › Height: 5" tall
- › Fitment: H series (1" x 2")
- › Material: Galvanized steel
- › Finish: Black rubber



### Part #

A69

#### EZ Hook and loop fastener Strap

- › Strap loops onto cross bar
- › Capacity: 75 lbs.
- › Fitment: All Vantech cross bars
- › Material: Nylon
- › Color: Black & red

## H1 Accessories

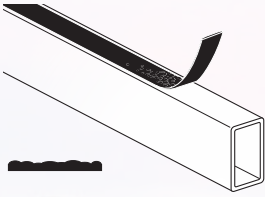

Part #	Length
BG-057	57"
BG-063	63"
BG-072	72"

### Plastic Bar Guard

- ▶ Textured plastic surface
- ▶ Adhesive backing
- ▶ Fitment: ST cross bars
- ▶ Material: Plastic
- ▶ Color: Black

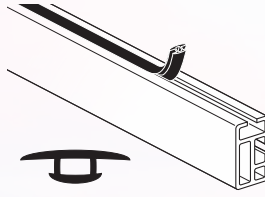

Part #	Length
BG-557	57"
BG-563	63"
BG-572	72"

### Rubber Bar Guard

- ▶ Non-slip rubber surface
- ▶ Press-In installation method
- ▶ Fitment: A613 cross bars
- ▶ Material: Rubber
- ▶ Color: Black

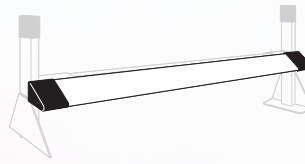

Part #	Size
WF-59	59"
WF-65	65"

### Wind Foil

- ▶ Decreases wind noise and vibrations
- ▶ Does not interfere with accessories
- ▶ Material: Aluminum
- ▶ Color: Anodized black  
Powder coated white

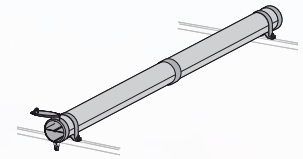

Part #	Description
CC-104	2 Compartment

### 6" x 128" Conduit Carrier Kit

- ▶ 3 or 4 compartments available (see page 110)
- ▶ Material: Aluminum
- ▶ Color: Anodized black  
Anodized silver  
Powder coated white
- ▶ Tube only available in silver

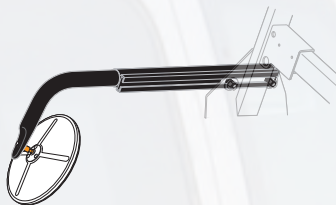

Part #	Adjustment
A81	25"-32"

### Back-Up 8" Convex

- ▶ Installs onto eye hooks
- ▶ Material: Aluminum
- ▶ Color: Anodized black  
Powder coated white

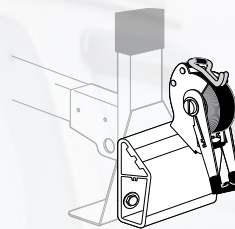

Part #
RTD10-H1

- ▶ Ratchet Tie-Down
- ▶ Bolt-on system (no drilling required)
- ▶ Self contained strap
- ▶ Strap: 1.5" x 120"
- ▶ Material: Stainless steel

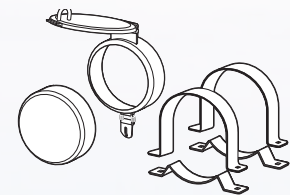

PART #
A40

- ▶ 6" Conduit Hatch & Cap
- ▶ No drilling required.
- ▶ Includes: Cross bar clamps
- ▶ Material: Aluminum
- ▶ Color: Anodized black  
Anodized silver  
Powder coated white

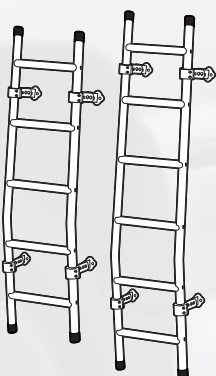

Height
56"
68"

### Rear Access Ladder

- ▶ Fitment: Conversion vans
- ▶ Material: Aluminum
- ▶ Color: Anodized black  
Anodized silver  
Powder coated white

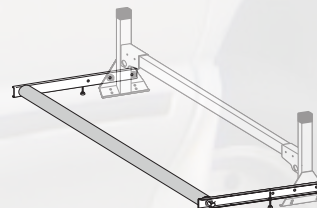

PART #	Width
ROH124-57	57"
ROH124-63	63"
ROH124-72	72"

### 24" Extension Roller

- ▶ Fitment: H series
- ▶ Material: Aluminum
- ▶ Color: Anodized black  
Anodized silver  
Powder coated white
- ▶ Roller only available in silver



## H1 Box Truck Rack System

- › Universal system
- › Bolts onto aluminum or fiberglass body
- › Drilling required
- › System can be side or top mounted
- › Cross bar lengths available in 63" - 96"
- › Low, standard and high profile mounting bases available
- › 4 x .75" eyehooks per mounting base for easy tie down
- › Materials available: steel, aluminum or stainless steel
- › Colors available: black, white or silver

### STEEL SYSTEM

- › Heavy duty grade
- › Economical

### ALUMINUM SYSTEM

- › Rust free
- › Stainless steel hardware
- › Lightweight

\*Accessories Not Included

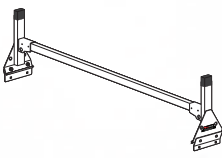
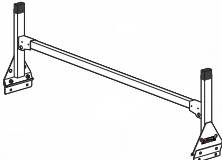
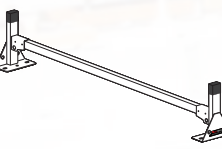
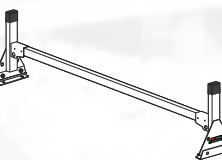
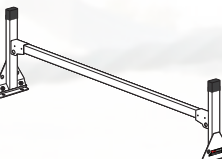
H1 Rack System	Description	Bar Length	Clearance	Color	ST	AL
	1 Bar System Standard Height Side Mount	63"	8.5"	B / W	H2191	H2224
		72"	8.5"	B / W	H2192	H2225
		84"	8.5"	B / W	H2193	H2226
		96"	8.5"	B / W	H2194	H2227
	1 Bar System High Profile Side Mount	63"	16.5"	B / W	H2197	H2230
		72"	16.5"	B / W	H2198	H2231
		84"	16.5"	B / W	H2199	H2232
		96"	16.5"	B / W	H2200	H2233
	1 Bar System Low Profile Top Mount	63"	5 5/8"	B / W	H2243	H2236
		72"	5 5/8"	B / W	H2244	H2237
		84"	5 5/8"	B / W	H2245	H2238
		96"	5 5/8"	B / W	H2246	H2239
	1 Bar System Standard Height Top Mount	63"	9"	B / W	H2179	H2212
		72"	9"	B / W	H2180	H2213
		84"	9"	B / W	H2181	H2214
		96"	9"	B / W	H2182	H2215
	1 Bar System High Profile Top Mount	63"	16"	B / W	H2185	H2218
		72"	16"	B / W	H2186	H2219
		84"	16"	B / W	H2187	H222
		96"	16"	B / W	H2188	H2221

## H1 Accessories



### Part #

A02

#### Ladder Guide

- › Height: 5.5" tall
- › Fitment: H series (1" x 2")
- › Material: Galvanized steel
- › Finish: Black rubber



### Part #

A06

#### Ladder Stopper

- › Height: 5" tall
- › Fitment: H series (1" x 2")
- › Material: Galvanized steel
- › Finish: Black rubber



### Part #

A69

#### EZ Hook and loop fastener Strap

- › Strap loops onto cross bar.
- › Strap loops onto cross bar
- › Capacity: 75 lbs.
- › Fitment: All Vantech cross bars
- › Material: Nylon
- › Color: Black & red

## H1 Accessories



Part #	Length
BG-063	63"
BG-072	72"
BG-084	84"
BG-096	96"

### Plastic Bar Guard

- › Textured plastic surface
- › Adhesive backing
- › Fitment: ST cross bars
- › Material: Plastic
- › Color: Black

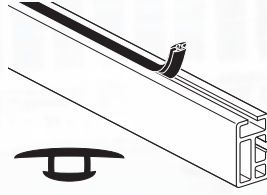

Part #	Length
BG-563	63"
BG-572	72"
BG-584	84"
BG-596	96"

### Rubber Bar Guard

- › Non-slip rubber surface
- › Press-In installation method
- › Fitment: A613 cross bars
- › Material: Rubber
- › Color: Black

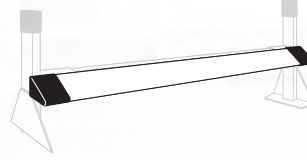

Part #	Size
WF-59	59"
WF-65	65"

### Wind Foil

- › Decreases wind noise and vibrations
- › Does not interfere with accessories
- › Material: Aluminum
- › Color: Anodized black  
Powder coated white

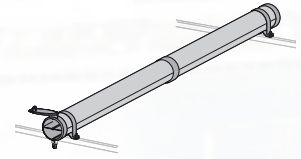

Part #	Description
CC-104	2 Compartment

### 6" x 128" Conduit Carrier Kit

- › 3 or 4 compartments available (see page 110)
- › Material: Aluminum
- › Color: Anodized black  
Anodized silver  
Powder coated white
- › Tube only available in silver

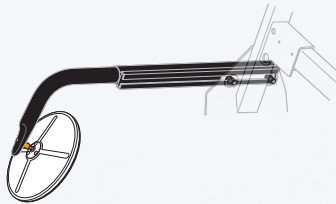

Part #	Adjustment
A81	25"-32"

### Back-Up 8" Convex

- › Installs onto eye hooks
- › Adjusts: 25" - 32"
- › Material: Aluminum
- › Color: Anodized black

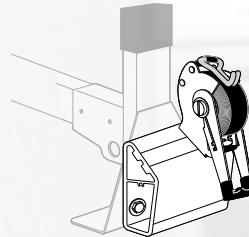

Part #
RTD10-H1

- › Ratchet Tie-Down
- › Bolt-on system (no drilling required)
- › Self contained strap
- › Strap: 1.5" x 120"
- › Material: Stainless steel

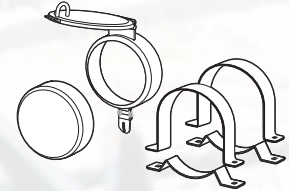

PART #
A40

- › 6" Conduit Hatch & Cap
- › No drilling required.
- › Includes: Cross bar clamps
- › Material: Aluminum
- › Color: Anodized black  
Anodized silver  
Powder coated white

Height	Depth	42"	48"	60"
48"	13"	SS4842-3	SS4848-3	SS4860-3
60"	13"	SS6042-4	SS6048-4	SS6060-4

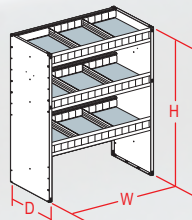
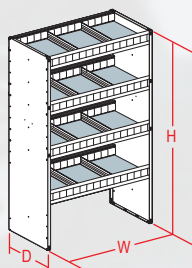

### Aluminum Interior Shelving

- › Fitment: Box trucks
- › Material: Aluminum
- › Color: Silver

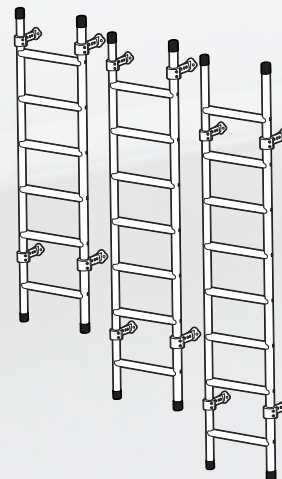

Part #	Height
L005	72"
L006	84"
L007	96"

### Rear Access Ladder

- › Fitment: Box trucks
- › Material: Aluminum
- › Color: Anodized black  
Anodized silver  
Powder coated white

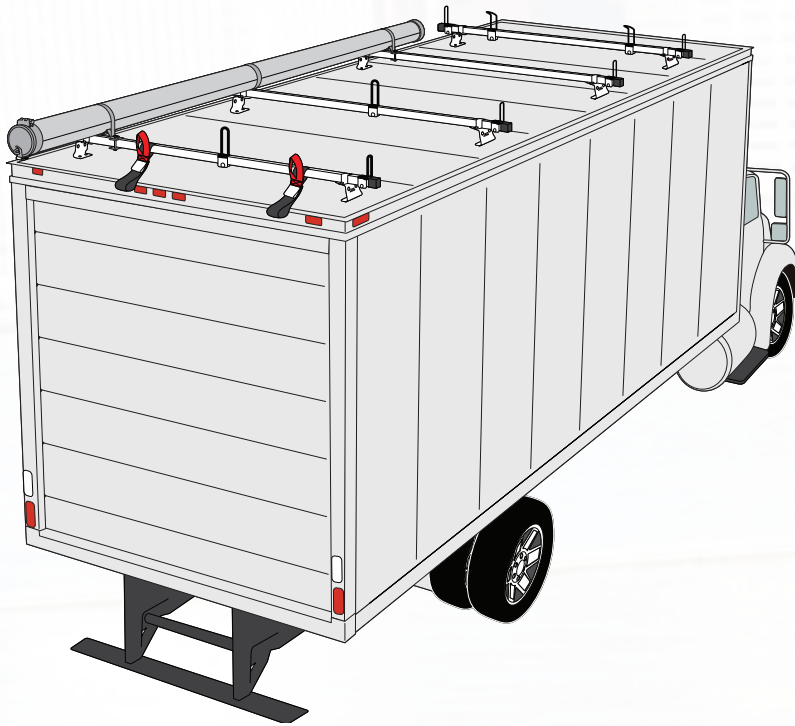

## M SERIES RACK SYSTEM

- › Universal system
- › Bolts onto aluminum or fiberglass body
- › Drilling required
- › Cross bar lengths available 60" - 84"
- › 10.75" total height with support
- › 6" extra wide mounting bases
- › Polyfoam gaskets for tight seal
- › 2 x .75" eyehooks per mounting base for easy tie down
- › Color available: black or white

## STEEL SYSTEM

- › Heavy duty grade
- › Economical

## ALUMINUM SYSTEM

- › Rust free
- › Stainless steel hardware
- › Lightweight

(more info see page 9)

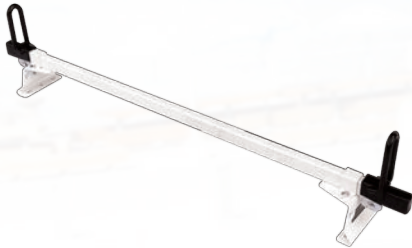
M series Rack System	Description	Bar Length	Material	Color	Weight
	Single Bar Included acc. As Shown	60"	ST	B / W	250 lbs.
		60"	AL	B / W	250 lbs.
		72"	ST	B / W	250 lbs.
		72"	AL	B / W	250 lbs.
		84"	ST	B / W	250 lbs.

## M series Accessories



Part #

A01

### Ladder Guide

- › Height: 5.5" tall
- › Fitment: M series (1" x 1.5")
- › Material: Galvanized steel
- › Finish: Black rubber



Part #

A05

### Ladder Stopper

- › Height: 5" tall
- › Fitment: M series (1" x 1.5")
- › Material: Galvanized steel
- › Finish: Black rubber



Part #

A09

### Side Support

- › Height: 5.5" tall
- › Fitment: M series (1" x 1.5")
- › Material: Galvanized steel
- › Finish: Black rubber

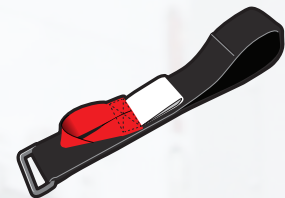

Part #

A69

### EZ Hook and loop fastener Strap

- › Strap loops onto cross bar
- › Capacity: 75 lbs.
- › Fitment: All Vantech cross bars
- › Material: Nylon
- › Color: Black & red

## M series Accessories

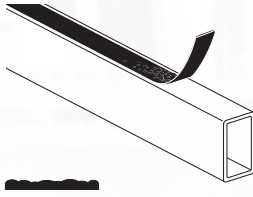

Part #	Length
BG-060	60"
BG-072	72"
BG-084	84"

### Plastic Bar Guard

- Textured plastic surface
- Adhesive backing
- Material: Plastic
- Color: Black



Part #	Length
BG-552	52"
BG-564	64"
BG-576	76"

### Rubber Bar Guard

- Non-slip rubber surface
- Press-In installation method
- Material: Rubber
- Color: Black

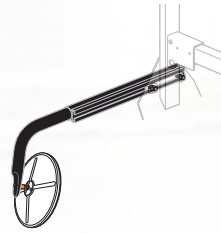

Part #	Adjustment
A82	25"-32"

### Back-Up 8" Convex Mirror

- Installs onto eye hooks
- Material: Aluminum
- Color: Anodized black



Part #	Size
WF-62	62"

### Wind Foil

- Decreases wind noise and vibrations
- Material: Aluminum
- Color: Anodized black  
Anodized silver  
Powder coated white

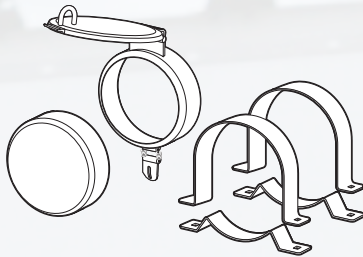

PART #
A37

### 6" Conduit Hatch & Cap

- No Drilling required
- Includes: Cross bar clamps
- Material: Aluminum
- Color: Anodized black  
Anodized silver  
Powder coated white

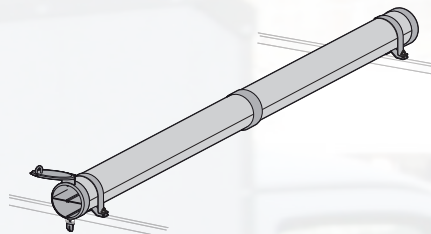

Part #	Description
CC-103	2 Compartment

### 6" x 128" long Conduit Carrier Kit

- 3 or 4 compartments available (see page 110)
- Material: Aluminum
- Color: Anodized black  
Anodized silver  
Powder coated white
- Tube only available in silver

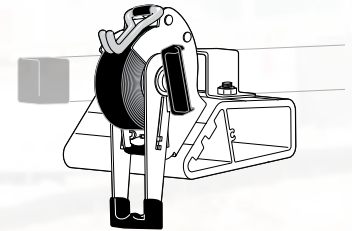

Part #
RTD10-M

### Ratchet Tie-Down

- Bolt-on system (no drilling required)
- Self contained strap
- Strap: 1.5" x 120"
- Material: Stainless steel

Height	Depth	42"	48"	60"
48"	13"	SS4842-3	SS4848-3	SS4860-3
60"	13"	SS6042-4	SS6048-4	SS6060-4

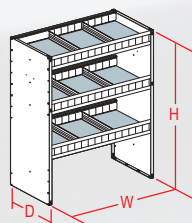
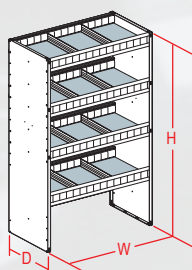

### Aluminum Interior Shelving

- Fitment: Box Trucks
- Material: Aluminum
- Color: Silver

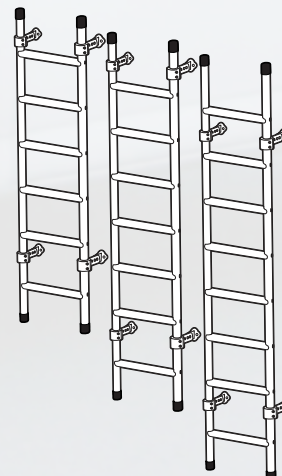

Part #	Height
L005	72"
L006	84"
L007	96"

### Rear Access Ladder

- Fitment: Box Trucks
- Material: Aluminum
- Color: Anodized black  
Anodized silver  
Powder coated white



## H1 RACK SYSTEM

- › Fastens onto vehicle using R16 tracks (optional)
- › Drilling required
- › Low profile 10.5" total clearance
- › 4 x .75" eyehooks per mounting base for easy tie down
- › Materials available: steel, aluminum or stainless steel
- › Colors available: black, white or silver

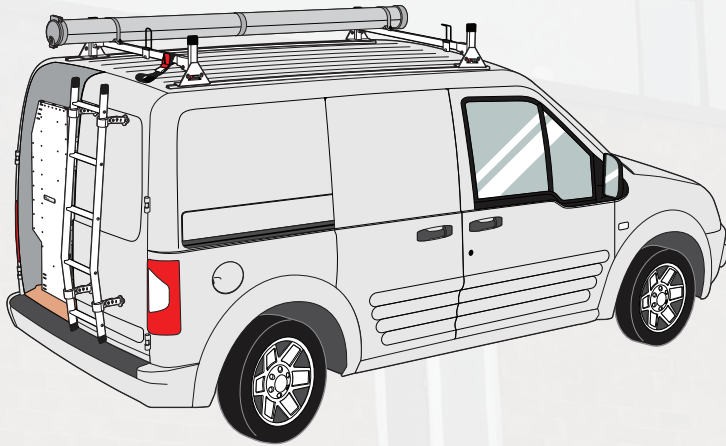

### STEEL SYSTEM

- › Heavy duty grade
  - › Economical
- ### ALUMINUM SYSTEM
- › Rust free
  - › Stainless steel hardware
  - › Lightweight

### STAINLESS STEEL SYSTEM

- › Rust free
- › Stainless steel hardware
- › Longer lasting durability

(more info see page 3)

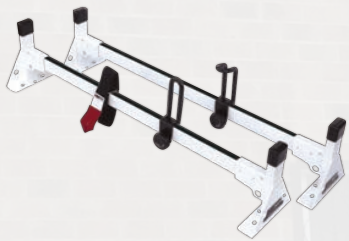
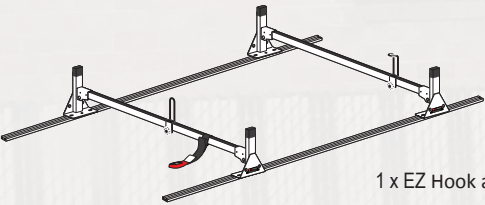
H1 Rack System	Description	Material	Color	Weight Capacity
	2 Bar System (Bolt-On)	ST	B / W	500 lbs.
	Included acc. 1 x Ladder Stopper 1 x Ladder Guide 1 x EZ Hook and loop fastener Strap	AL	B / W / S	500 lbs.
		SS	SS	600 lbs.
	2 Bar System with R16 Tracks	ST	B / W	500 lbs.
	Included acc. 1 x Ladder Stopper 1 x Ladder Guide 1 x EZ Hook and loop fastener Strap	AL	B / W / S	500 lbs.
	2 x R16 Track	SS	SS	600 lbs.

## H1 Accessories

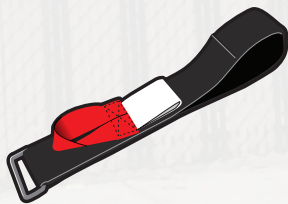

Part #

A69

### EZ Hook and loop fastener Strap

- › Strap loops onto cross bar
- › Capacity: 75 lbs.
- › Fitment: All Vantech cross bars
- › Material: Nylon
- › Color: Black & red



Part #

A02

### Ladder Guide

- › Height: 5.5" tall
- › Fitment: H series (1" x 2")
- › Material: Galvanized steel
- › Finish: Black rubber



Part #

A06

### Ladder Stopper

- › Height: 5" tall
- › Fitment: H series (1" x 2")
- › Material: Galvanized steel
- › Finish: Black rubber

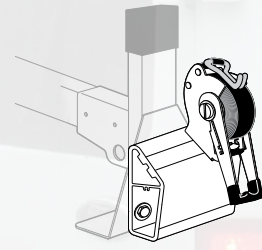

Part #

RTD10-H1

### Ratchet Tie-Down

- › Bolt-on system (no drilling required)
- › Self contained strap
- › Strap: 1.5" x 120"
- › Material: Stainless steel/Aluminum

## H1 Accessories

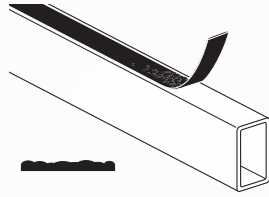

Part #	Length
BG-042	42"

### Plastic Bar Guard

- › Textured plastic surface
- › Adhesive backing
- › Fitment: ST or SS cross bars
- › Material: Plastic
- › Color: Black

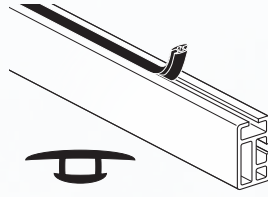

Part #	Length
BG-534	34"

### Rubber Bar Guard

- › Non-slip rubber surface
- › Press-In installation method
- › Fitment: A613 cross bars
- › Material: Rubber
- › Color: Black

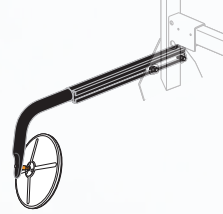

Part #	Adjustment
A81	25"-32"

### Back-Up 8" Convex Mirror

- › Installs onto eye hooks
- › Material: Aluminum
- › Color: Anodized black

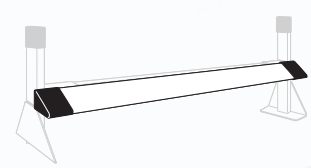

Part #	Length
WF-41	41"

### Wind Foil

- › Decreases wind noise and vibrations
- › Does not interfere with accessories
- › Material: Aluminum
- › Color: Anodized black  
Powder coated white

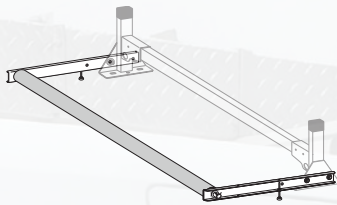

PART #
ROH124-42

### Roller Extension

- › Adjustable 16" or 20"
- › Adjustable riser for added support
- › Material: Aluminum
- › Color: Anodized black  
Anodized silver  
Powder coated white
- › Roller only available in silver

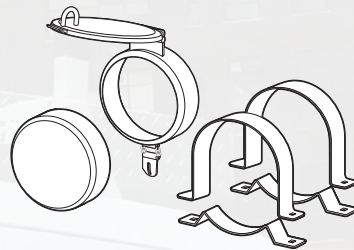

PART #
A40

- › 6" Conduit Hatch & Cap
- › No drilling required.
- › Includes: Cross bar clamps
- › Material: Aluminum
- › Color: Anodized black  
Anodized silver  
Powder coated white

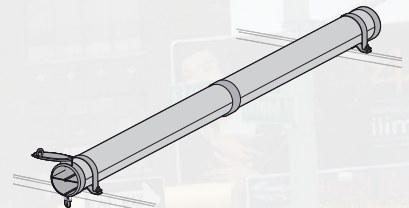

Part #	Description
CC-104	2 Compartment

### 6" x 128" Conduit Carrier Kit

- › 3 or 4 compartments available (see page 110)
- › Material: Aluminum
- › Color: Anodized black  
Anodized silver  
Powder coated white
- › Tube only available in silver

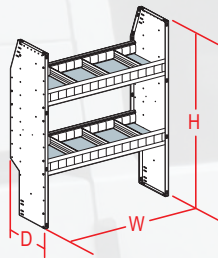

Depth	Height	36"	42"	48"	60"
11"	46"	SA4636-2	SA4642-2	SA4648-2	SA4660-2

### Aluminum Interior Shelving

- › Fitment: Transit Connect 2008-13
- › Material: Aluminum
- › Levels: 2
- › Color: Silver



Part #	Height
L001	56"

### Rear Access Ladder

- › Fitment: Ford Transit Connect
- › Material: Aluminum
- › Color: Anodized black  
Anodized silver  
Powder coated white

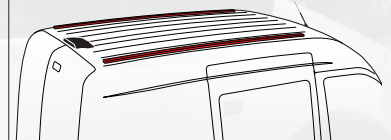

Part #
R16

### R16 Tracks

- › Drilling required (Includes anchor kit)
- › Fitment: Transit Connect 2008-13
- › Material: Aluminum
- › Color: Anodized silver

## H2 RACK SYSTEM

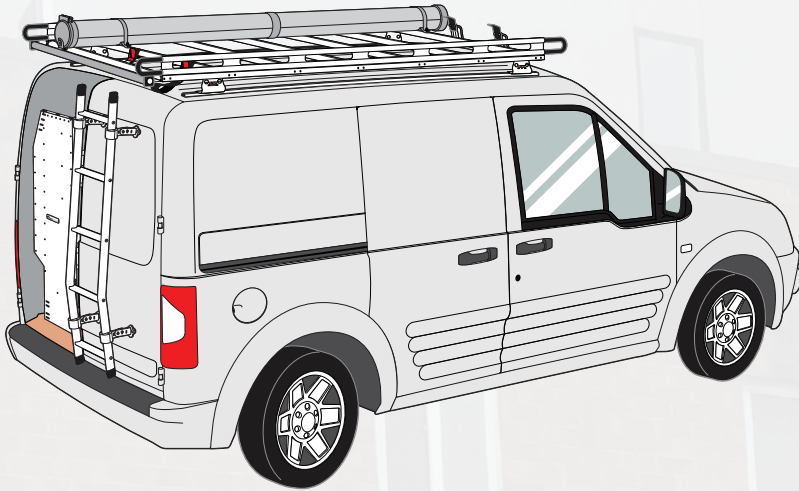

- › Fastens onto vehicle using R16 tracks (included)
- › Drilling required
- › All aluminum design
- › Multiple cross bars at 16" apart
- › 2.25" x 1" x 50" cross bars
- › Built-in channels on the cargo rails and cross bars for additional accessories
- › Cargo rail length 96"
- › Rear adjustable roller allows for easy loading and unloading
- › Roller can extend beyond the edge of the roof
- › Colors available: black, white or silver

H2 Rack System	Description	Cross Bar	Color	Capacity
	H2 96" Cargo System	50"	B / W / S	600 lbs.

## H2 Accessories



Part #

A20

### Adjustable Guide

- › Height: 5" tall
- › Fitment: Cross bars with channels
- › Material: Galvanized steel rubber dipped

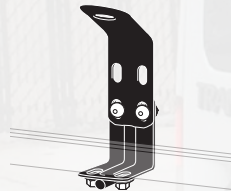

Part #

A57

### Ladder Stopper

- › Height: 5-7" tall
- › Material: Galvanized steel rubber dipped
- › Color: Black

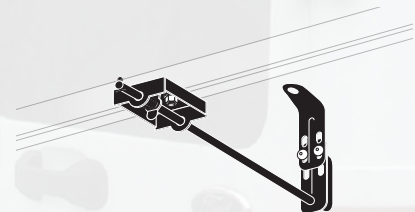

Part #

A64

### Push 2 Secure

- › Secure and lock ladder
- › Material: Galvanized steel rubber dipped
- › Color: Black

## H2 Accessories

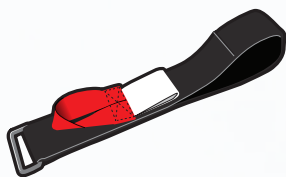

Part #
A69

### EZ Hook and loop fastener Strap

- › Strap loops onto cross bar
- › Capacity: 75 lbs.
- › Fitment: All Vantech cross bars
- › Material: Nylon
- › Color: Black & red

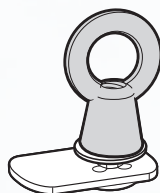

Part #	Size
A24	1"
A59	1.25"

### Eye hook

- › Fitment: Slides into aluminum channels
- › Material: Stainless steel
- › Color: Silver

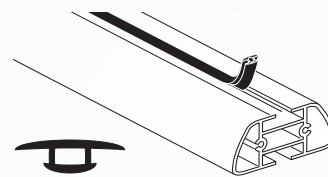

Part #	Length
BG-549	49"

### Rubber Bar Guard

- › Non-slip rubber surface
- › Press-In installation method
- › Fitment: A285 cross bars
- › Material: Rubber
- › Color: Black

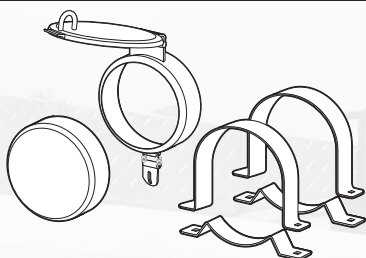

PART #
A34

### 6" Conduit Carrier Hatch & Cap

- › No drilling required
- › Secures to bars with sliders.
- › Material: Aluminum
- › Color: Anodized black  
Anodized silver  
Powder coated white

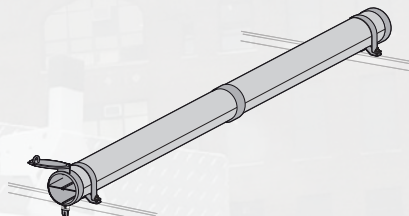

Part #	Description
CC-101	2 Compartment

### 6" x 128" Conduit Carrier Kit

- › 3 or 4 compartments available (see page 110)
- › Material: Aluminum
- › Color: Anodized black  
Anodized silver  
Powder coated white
- › Tube only available in silver

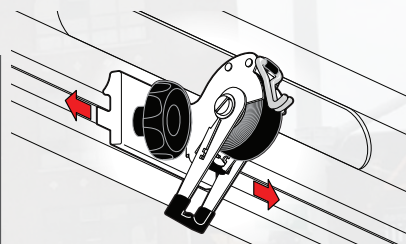

Part #
RTD10-H2

### Ratchet Tie-Down

- › Bolt-on system (no drilling required)
- › Self contained strap
- › Strap: 1.5" x 120"
- › Material: Stainless steel/Aluminum

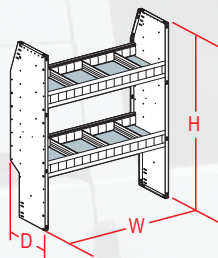

Depth	Height	36"	42"	48"	60"
11"	46"	SA4636-2	SA4642-2	SA4648-2	SA4660-2

### Aluminum Interior Shelving

- › Fitment: Transit Connect 2008-13
- › Material: Aluminum
- › Levels: 2
- › Color: Silver



Part #	Height
L001	56"

### Rear Access Ladder

- › Fitment: Ford Transit Connect
- › Material: Aluminum
- › Color: Anodized black  
Anodized silver  
Powder coated white

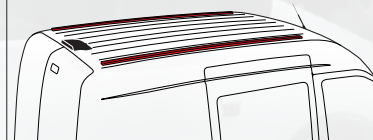

Part #
R16

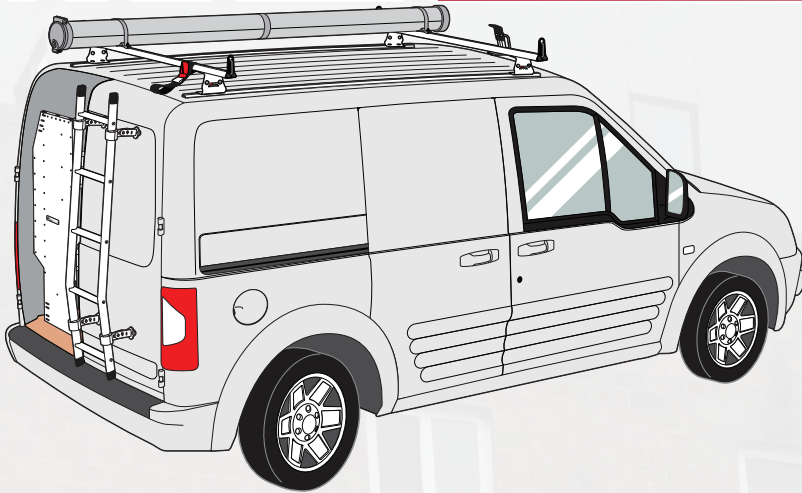

### R16 Tracks

- › Drilling required (Includes anchor kit)
- › Fitment: Transit Connect 2008-13
- › Material: Aluminum
- › Color: Anodized silver



## J SERIES RACK SYSTEM

- › 2 installation methods available:
  - › (a) Direct bolt-on to existing factory mounting points
  - › (b) Installing R16 tracks (fastens to existing mounting points additional drilling required)
- › 2.25" x 1" or 3" x 1.5" cross bars available
- › All aluminum design
- › 4" wide mounting bases
- › Heavy duty 1/8" thick mounting bases
- › Built-in channels on the cross bars for additional accessories
- › 2 x .75" eyehooks per mounting base for easy tie down
- › Colors available: black, white or silver

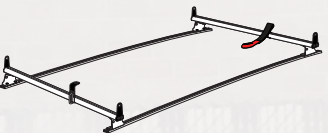
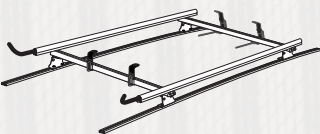
J series Rack System	Description	Cross Bar	Material	Bar Type	Color	Capacity
	J1000 2 Bar System (Bolt-On)	50"	Aluminum	A285	B / W / S	400 lbs.
		55"	Aluminum	A286	B / W / S	500 lbs.
	J1000 2 Bar System with R16 Tracks	50"	Aluminum	A285	B / W / S	500 lbs.
		55"	Aluminum	A286	B / W / S	600 lbs.
	J2000 2 Bar System (Bolt-On)  Included acc. 1 x Ladder Stopper 1 x Hook and loop fastener Strap 4 x Side Supports	50"	Aluminum	A285	B / W / S	400 lbs.
		55"	Aluminum	A286	B / W / S	500 lbs.
	J2000 2 Bar System with R16 Tracks  Included acc. 1 x Ladder Stopper 1 x Hook and loop fastener Strap 4 x Side Supports 2 x R16 Tracks	50"	Aluminum	A285	B / W / S	500 lbs.
		55"	Aluminum	A286	B / W / S	600 lbs.
	J4000 2 Bar System with R16 Tracks  Included acc. 2 x Ladder Stopper 2 x Push2Secure 2 x Side Rails 2 x R16 Tracks	50"	Aluminum	A285	B / W / S	500 lbs.

## J series Accessories



Part #

A03 / A04

### Side Support

- › Height : 4" tall from top of cross bar
- › Fitment: A03 fits A286 cross bars  
A04 fits A285 cross bars
- › Material: Galvanized steel rubber dipped



Part #

A20

### Adjustable Guide

- › Height: 5" tall
- › Fitment: Cross bars with channels
- › Material: Galvanized steel rubber dipped

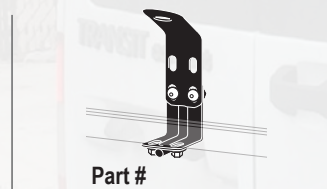

Part #

A57

### Ladder Stopper

- › Height: 5-7" tall
- › Material: Galvanized steel rubber dipped
- › Color: Black

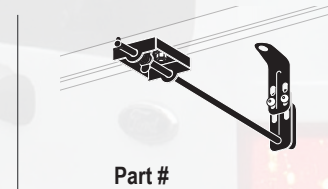

Part #

A64

### Push 2 Secure

- › Secure and lock ladder
- › Material: Galvanized steel rubber dipped
- › Color: Black

## J series Accessories



Part #
A69

**EZ Hook and loop fastener Strap**

- › Strap loops onto cross bar
- › Capacity: 75 lbs.
- › Fitment: All Vantech cross bars
- › Material: Nylon
- › Color: Black & red

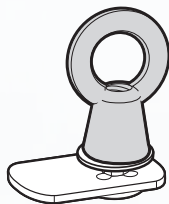

Part #	Size
A24	1"
A59	1.25"

**1" Eye hook**

- › Fitment: Slides into aluminum channels
- › Material: Stainless steel
- › Color: Silver

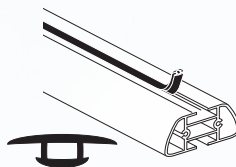

Part #	Length
BG-050	50"
BG-055	55"

**Rubber Bar Guard**

- › Non-slip rubber surface
- › Press-In installation method
- › Fitment: A285 / A286 cross bars
- › Material: Rubber
- › Color: Black

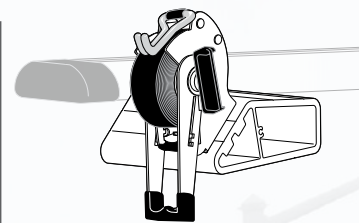

Part #
RTD10-H3

**Ratchet Tie-Down**

- › Bolt-on system (no drilling required)
- › Self contained strap
- › Strap: 1.5" x 120"
- › Material: Stainless steel

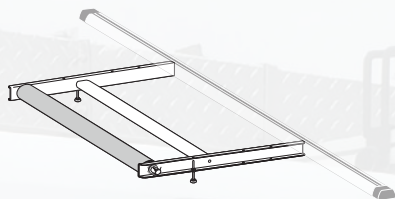

PART #
ROH324-36

**Roller Extension**

- › Adjustable 10" - 20"
- › Fitment: A285/A286 cross bars
- › Material: Aluminum
- › Color: Anodized black  
Anodized silver  
Powder coated white
- › Roller only available in silver

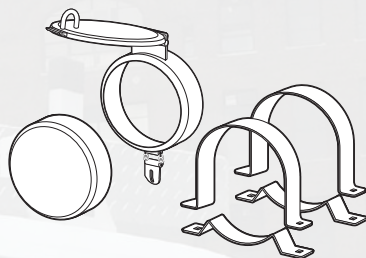

PART #
A34

**6" Conduit Hatch & Cap**

- › No drilling required
- › Secures to bars with sliders
- › Material: Aluminum
- › Color: Anodized black  
Anodized silver  
Powder coated white

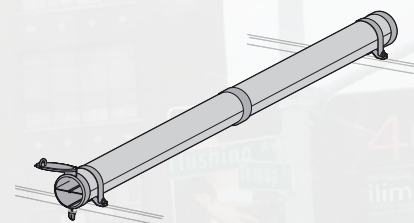

Part #	Description
CC-101	2 Compartment

**6" x 128" Conduit Carrier Kit**

- › 3 or 4 compartments available (see page 110)
- › Material: Aluminum
- › Color: Anodized black  
Anodized silver  
Powder coated white
- › Tube only available in silver

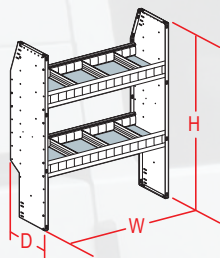

Depth	Height	36"	42"	48"	60"
11"	46"	SA4636-2	SA4642-2	SA4648-2	SA4660-2

**Aluminum Interior Shelving**

- › Fitment: Transit Connect 2008-13
- › Material: Aluminum
- › Levels: 2
- › Color: Silver



Part #	Height
L001	56"

**Rear Access Ladder**

- › Fitment: Ford Transit Connect
- › Material: Aluminum
- › Color: Anodized black  
Anodized silver  
Powder coated white

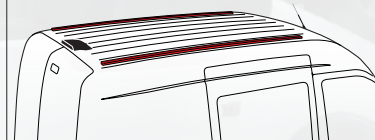

Part #
R16

**R16 Tracks**

- › Drilling required (Includes anchor kit)
- › Fitment: Transit Connect 2008-13
- › Material: Aluminum
- › Color: Anodized silver

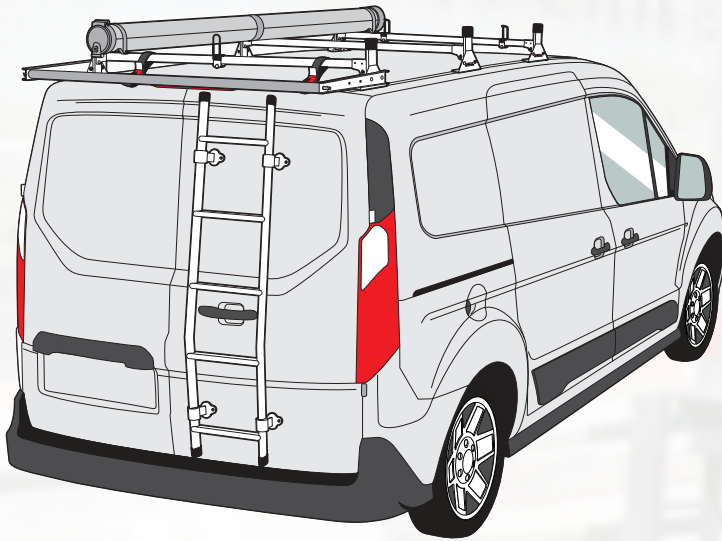

## H1 RACK SYSTEM

- › Fastens onto existing factory mounting points
- › Fits XL and XLT models
- › 45" wide loading area
- › Low profile 10.5" total clearance
- › 4 x .75" eyehooks per mounting base for easy tie down
- › Materials available: steel, aluminum or stainless steel
- › Colors available: black, white or silver

### STEEL SYSTEM

- › Heavy duty grade
- › Economical

### STAINLESS STEEL SYSTEM

- › Rust free
- › Stainless steel hardware
- › Longer lasting durability

### ALUMINUM SYSTEM

- › Rust free
- › Stainless steel hardware
- › Lightweight

(more info see page 3)

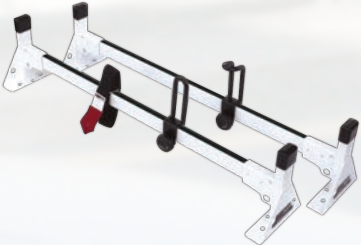
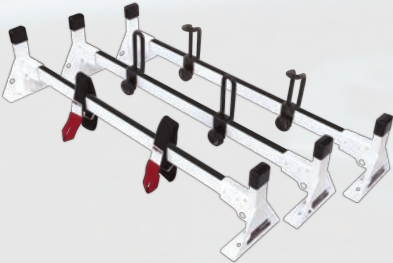
H1 Rack System	Description	Material	Color	Capacity
	2 Bar System (Bolt-On)	ST	B / W	500 lbs.
	Included acc. 1 x Ladder Stopper 1 x Ladder Guide	AL	B / W / S	500 lbs.
	1 x EZ Hook and loop fastener Strap	SS	SS	600 lbs.
	3 Bar System (Bolt-On)	ST	B / W	750 lbs.
	Included acc. 2 x Ladder Stopper 2 x Ladder Guide	AL	B / W / S	750 lbs.
	2 x EZ Hook and loop fastener Strap	SS	SS	900 lbs.

## H1 Accessories

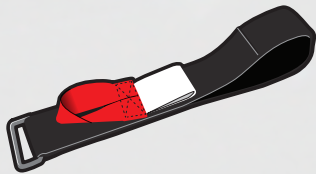

Part #

A69

### EZ Hook and loop fastener Strap

- › Strap loops onto cross bar
- › Capacity: 75 lbs.
- › Fitment: All Vantech cross bars
- › Material: Nylon
- › Color: Black & red



Part #

A02

### Ladder Guide

- › Height: 5.5" tall
- › Fitment: H series (1" x 2")
- › Material: Galvanized steel
- › Finish: Black rubber



Part #

A06

### Ladder Stopper

- › Height: 5" tall
- › Fitment: H series (1" x 2")
- › Material: Galvanized steel
- › Finish: Black rubber

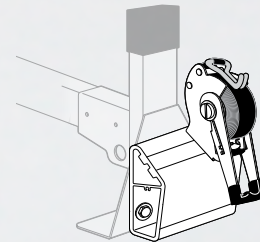

Part #

RTD10-H1

### Ratchet Tie-Down

- › Bolt-on system (no drilling required)
- › Self contained strap
- › Strap: 1.5" x 120"
- › Material: Stainless steel/Aluminum

## H1 Accessories

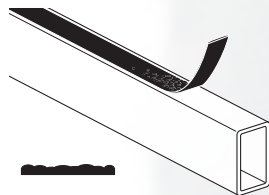

**Part # Length**

BG-046 46"

### Plastic Bar Guard

- Textured plastic surface
- Adhesive backing
- Fitment: ST or SS cross bars
- Material: Plastic
- Color: Black



**Part # Length**

BG-538 38"

### Rubber Bar Guard

- Non-slip rubber surface
- Press-In installation method
- Fitment: A613 cross bars
- Material: Rubber
- Color: Black

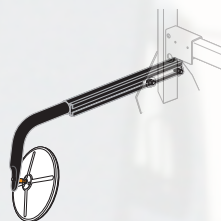

**Part # Adjustment**

A81 25"-32"

### Back-Up 8" Convex Mirror

- Installs onto eye hooks
- Material: Aluminum
- Color: Anodized black

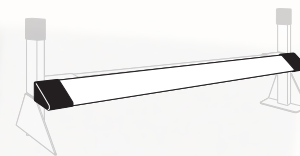

**Part # Length**

WF-48 48"

### Wind Foil

- Decreases wind noise and vibrations
- Does not interfere with accessories
- Material: Aluminum
- Color: Anodized black  
Powder coated white

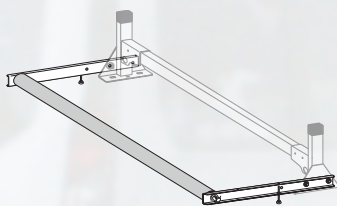

**PART #**

ROH124-47

### Roller Extension

- Adjustable 16" or 20"
- Adjustable riser for added support
- Material: Aluminum
- Color: Anodized black  
Anodized silver  
Powder coated white
- Roller only available in silver

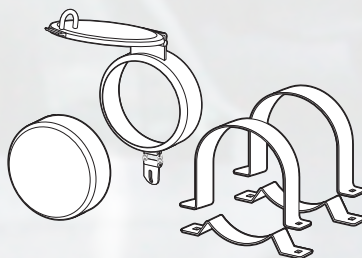

**PART #**

A40

- 6" Conduit Hatch & Cap
- No drilling required.
- Includes: Cross bar clamps
- Material: Aluminum
- Color: Anodized black  
Anodized silver  
Powder coated white

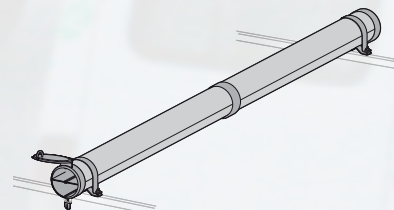

**Part # Description**

CC-104 2 Compartment

### 6" x 128" Conduit Carrier Kit

- 3 or 4 compartments available (see page 110)
- Material: Aluminum
- Color: Anodized black  
Anodized silver  
Powder coated white
- Tube only available in silver

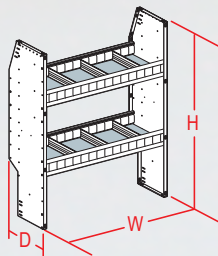

Depth	Height	36"	42"	48"	60"
11"	46"	SA4636-2	SA4642-2	SA4648-2	SA4660-2

### Aluminum Interior Shelving

- Fitment: Transit Connect 2014-On
- Material: Aluminum
- Levels: 2
- Color: Silver



**Part # Height**

L001 56"

### Rear Access Ladder

- Fitment: Ford Transit Connect
- Material: Aluminum
- Color: Anodized black  
Anodized silver  
Powder coated white

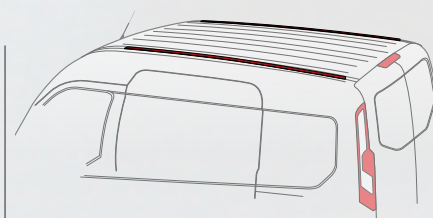

**Part # Fitment**

R17 XL

R18 XLT

D059 2 Bar Hardware kit

D060 3 Bar Hardware kit

### Optional Track Kit

- Fitment: Transit Connect 2014-On
- Material: Aluminum
- Color: Anodized silver



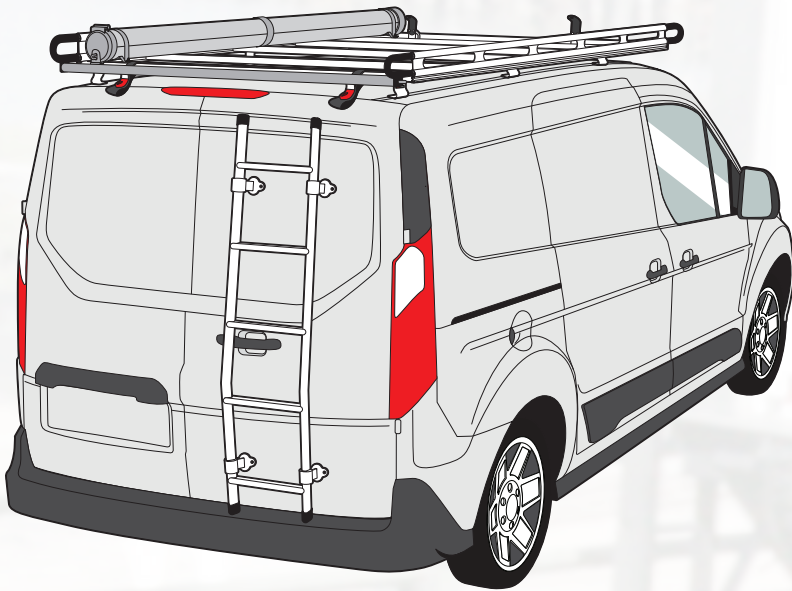

## H2 RACK SYSTEM

- › Fastens onto existing factory mounting points
- › Fits XL and XLT models
- › All aluminum design
- › Multiple cross bars at 16" apart
- › 2.25" x 1" x 50" cross bars
- › Built-in channels on the cargo rails and cross bars for additional accessories
- › Cargo rail length 96"
- › Rear adjustable roller allows for easy loading and unloading
- › Roller can extend beyond the edge of the roof
- › Colors available: black, white or silver

### H2 Rack System

### Description

### Cross Bar

### Color

### Capacity



H2 96" Cargo System

50"

B / W / S

600 lbs.

## H2 Accessories



### Part #

A20

#### Adjustable Guide

- › Height: 5" tall
- › Fitment: Cross bars with channels
- › Material: Galvanized steel rubber dipped

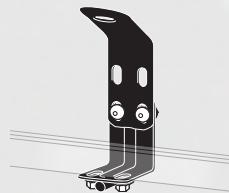

### Part #

A57

#### Ladder Stopper

- › Height: 5-7" tall
- › Material: Galvanized steel rubber dipped
- › Color: Black

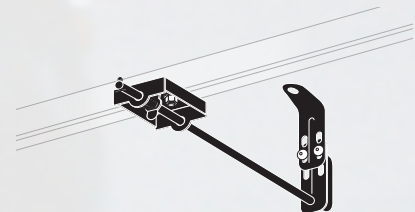

### Part #

A64

#### Push 2 Secure

- › Secure and lock ladder
- › Material: Galvanized steel rubber dipped
- › Color: Black

## H2 Accessories

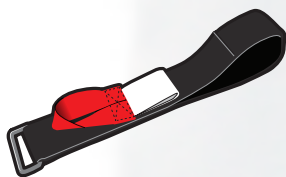

**Part #**

A69

**EZ Hook and loop fastener Strap**

- › Strap loops onto cross bar
- › Capacity: 75 lbs.
- › Fitment: All Vantech cross bars
- › Material: Nylon
- › Color: Black & red

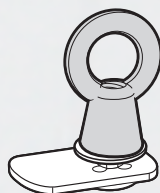

**Part #      Size**

A24      1"

A59      1.25"

**Eye hook**

- › Fitment: Slides into aluminum channels
- › Material: Stainless steel
- › Color: Silver

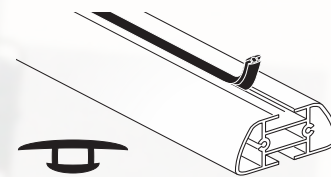

**Part #**

BG-549

**Rubber Bar Guard**

- › Non-slip rubber surface
- › Press-In installation method
- › Fitment: A285 cross bars
- › Material: Rubber
- › Color: Black

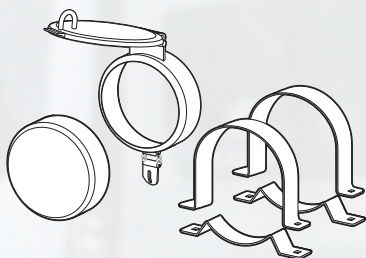

**PART #**

A34

**6" Conduit Carrier Hatch & Cap**

- › No drilling required
- › Secures to bars with sliders.
- › Material: Aluminum
- › Color: Anodized black  
Anodized silver  
Powder coated white

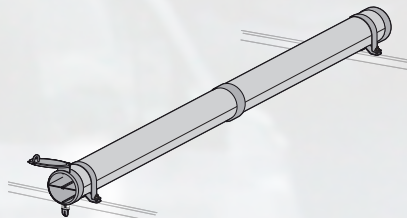

**Part #      Description**

CC-101      2 Compartment

**6" x 128" Conduit Carrier Kit**

- › 3 or 4 compartments available (see page 110)
- › Material: Aluminum
- › Color: Anodized black  
Anodized silver  
Powder coated white
- › Tube only available in silver

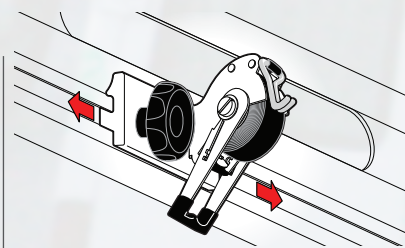

**Part #**

RTD10-H2

**Ratchet Tie-Down**

- › Bolt-on system (no drilling required)
- › Self contained strap
- › Strap: 1.5" x 120"
- › Material: Stainless steel/Aluminum

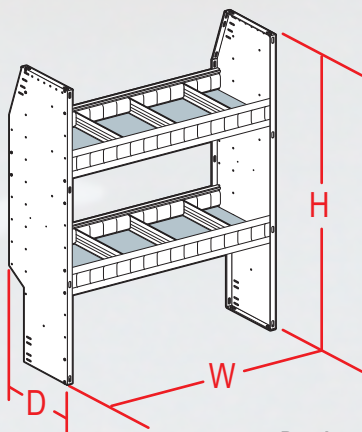

**Aluminum Interior Shelving**

- › Fitment: Transit Connect 2014-On
- › Material: Aluminum
- › Levels: 2
- › Color: Silver

Depth	Height	36"	42"	48"	60"
11"	46"	SA4636-2	SA4642-2	SA4648-2	SA4660-2

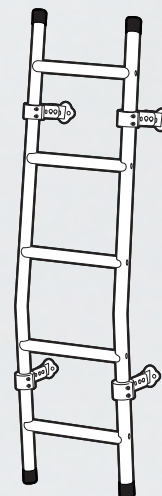

**Part #      Height**

L001      56"

**Rear Access Ladder**

- › Fitment: Ford Transit Connect
- › Material: Aluminum
- › Color: Anodized black  
Anodized silver  
Powder coated white

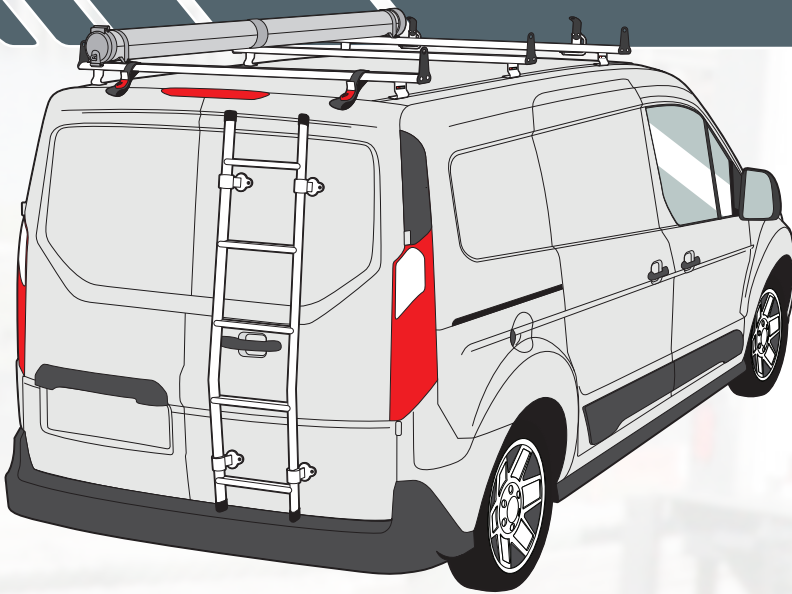

## J SERIES RACK SYSTEM

- › Fastens onto existing factory mounting points
- › Fits XL and XLT models
- › 2.25" x 1" or 3" x 1.5" cross bars available
- › All aluminum design
- › 2.75" wide mounting bases
- › Heavy duty 1/8" thick mounting bases
- › Built-in channels on the cross bars for additional accessories
- › Colors available: black, white or silver

J series Rack System	Description	Cross Bar	Material	Bar Type	Color	Capacity
	J1000 2 Bar System (Bolt-On)	50"	Aluminum	A285	B / W / S	400 lbs.
		55"	Aluminum	A286	B / W / S	500 lbs.
	J1000 3 Bar System (Bolt-On)	50"	Aluminum	A285	B / W / S	600 lbs.
		55"	Aluminum	A286	B / W / S	750 lbs.
	J2000 2 Bar System (Bolt-On)	50"	Aluminum	A285	B / W / S	400 lbs.
		55"	Aluminum	A286	B / W / S	500 lbs.
	J2000 3 Bar System (Bolt-On)	50"	Aluminum	A285	B / W / S	600 lbs.
		55"	Aluminum	A286	B / W / S	750 lbs.

## J series Accessories

<p><b>Part #</b> A03 / A04</p> <p><b>Side Support</b></p> <ul style="list-style-type: none"> <li>› Height : 4" tall from top of cross bar</li> <li>› Fitment: A03 fits A286 cross bars A04 fits A285 cross bars</li> <li>› Material: Galvanized steel rubber dipped</li> </ul>	<p><b>Part #</b> A20</p> <p><b>Adjustable Guide</b></p> <ul style="list-style-type: none"> <li>› Height: 5" tall</li> <li>› Fitment: Cross bars with channels</li> <li>› Material: Galvanized steel rubber dipped</li> </ul>	<p><b>Part #</b> A57</p> <p><b>Ladder Stopper</b></p> <ul style="list-style-type: none"> <li>› Height: 5-7" tall</li> <li>› Material: Galvanized steel rubber dipped</li> <li>› Color: Black</li> </ul>	<p><b>Part #</b> A64</p> <p><b>Push 2 Secure</b></p> <ul style="list-style-type: none"> <li>› Secure and lock ladder</li> <li>› Material: Galvanized steel rubber dipped</li> <li>› Color: Black</li> </ul>
--	--	---	---

## J series Accessories

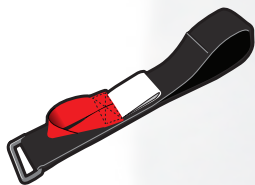

**Part #**

A69

**EZ Hook and loop fastener Strap**

- › Strap loops onto cross bar
- › Capacity: 75 lbs.
- › Fitment: All Vantech cross bars
- › Material: Nylon
- › Color: Black & red

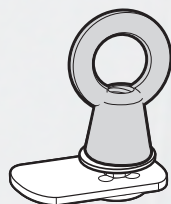

**Part # Size**

A24 1"

**1" Eye hook**

- › Fitment: Slides into aluminum channels
- › Material: Stainless steel
- › Color: Silver



**Part # Length**

BG-050 50"

BG-055 55"

**Rubber Bar Guard**

- › Non-slip rubber surface
- › Press-In installation method
- › Fitment: A285 / A286 cross bars
- › Material: Rubber
- › Color: Black

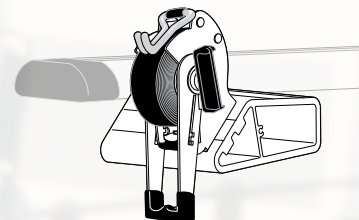

**Part #**

RTD10-H3

**Ratchet Tie-Down**

- › Bolt-on system (no drilling required)
- › Self contained strap
- › Strap: 1.5" x 120"
- › Material: Stainless steel/Aluminum

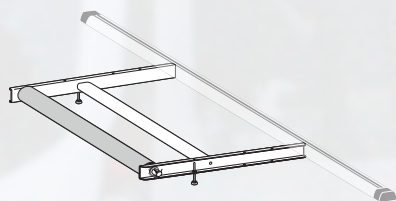

**PART #**

ROH324-36

**Roller Extension**

- › Adjustable 10" - 20"
- › Fitment: A285/A286 cross bars
- › Material: Aluminum
- › Color: Anodized black  
Anodized silver  
Powder coated white
- › Roller only available in silver

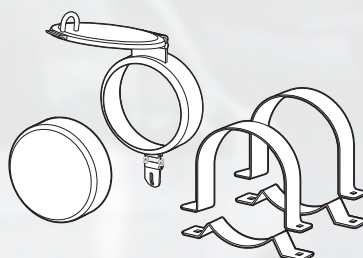

**PART #**

A34

**6" Conduit Hatch & Cap**

- › No drilling required
- › Secures to bars with sliders
- › Material: Aluminum
- › Color: Anodized black  
Anodized silver  
Powder coated white

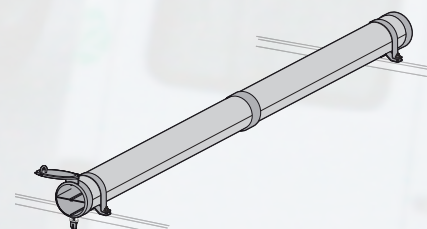

**Part # Description**

CC-101 2 Compartment

**6" x 128" Conduit Carrier Kit**

- › 3 or 4 compartments available (see page 110)
- › Material: Aluminum
- › Color: Anodized black  
Anodized silver  
Powder coated white
- › Tube only available in silver

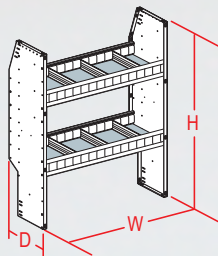

Depth	Height	36"	42"	48"	60"
11"	46"	SA4636-2	SA4642-2	SA4648-2	SA4660-2

**Aluminum Interior Shelving**

- › Fitment: Transit Connect 2014-On
- › Material: Aluminum
- › Levels: 2
- › Color: Silver

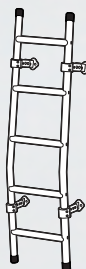

**Part # Height**

L001 56"

**Rear Access Ladder**

- › Fitment: Ford Transit Connect
- › Material: Aluminum
- › Color: Anodized black  
Anodized silver  
Powder coated white

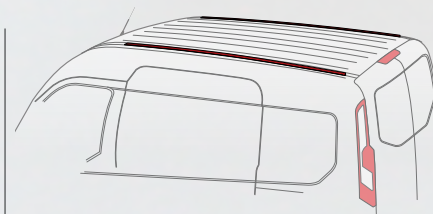

**Part # Fitment**

R17 XL

R18 XLT

D053 2 Bar Hardware kit

D054 3 Bar Hardware kit

**Optional Track Kit**

- › Fitment: Transit Connect 2014-On
- › Material: Aluminum
- › Color: Anodized silver

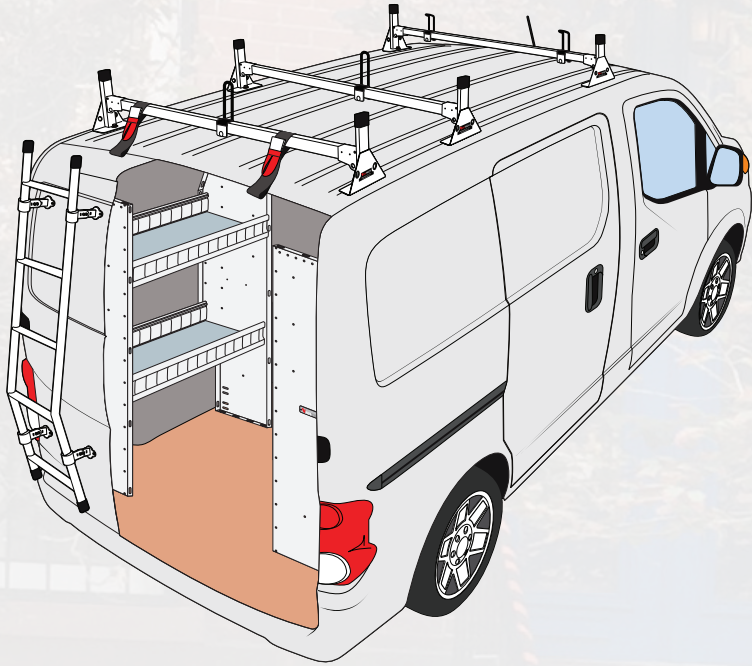

## H1 RACK SYSTEM

- › Fastens onto existing factory mounting points
- › Fits all models
- › 45" wide loading area
- › Low profile 10.5" total clearance
- › 4 x .75" eyehooks per mounting base for easy tie down
- › Materials available: steel, aluminum or stainless steel
- › Colors available: black, white or silver

### STEEL SYSTEM

- › Heavy duty grade
  - › Economical
- ### ALUMINUM SYSTEM
- › Rust free
  - › Stainless steel hardware
  - › Lightweight

### STAINLESS STEEL SYSTEM

- › Rust free
- › Stainless steel hardware
- › Longer lasting durability

(more info see page 3)

H1 Rack System	Description	Material	Color	Capacity	NV200	City Express
	2 Bar System (Bolt-On)	ST	B / W	500 lbs.	H1602	H1606
	Included acc. 1 x Ladder Stopper 1 x Ladder Guide	AL	B / W / S	500 lbs.	H1612	H1616
	1 x EZ Hook and loop fastener Strap	SS	SS	600 lbs.	H1622	H1626
	3 Bar System (Bolt-On)	ST	B / W	750 lbs.	H1603	H1607
	Included acc. 2 x Ladder Stopper 2 x Ladder Guide	AL	B / W / S	750 lbs.	H1613	H1617
	2 x EZ Hook and loop fastener Strap	SS	SS	900 lbs.	H1623	H1627

## H1 Accessories



Part #

A69

### EZ Hook and loop fastener Strap

- › Strap loops onto cross bar
- › Capacity: 75 lbs.
- › Fitment: All Vantech cross bars
- › Material: Nylon
- › Color: Black & red



Part #

A02

### Ladder Guide

- › Height: 5.5" tall
- › Fitment: H series (1" x 2")
- › Material: Galvanized steel
- › Finish: Black rubber



Part #

A06

### Ladder Stopper

- › Height: 5" tall
- › Fitment: H series (1" x 2")
- › Material: Galvanized steel
- › Finish: Black rubber

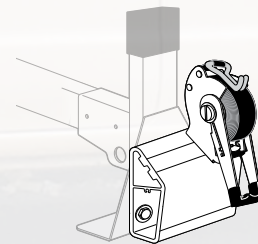

Part #

RTD10-H1

### Ratchet Tie-Down

- › Bolt-on system (no drilling required)
- › Self contained strap
- › Strap: 1.5" x 120"
- › Material: Stainless steel/Aluminum

## H1 Accessories

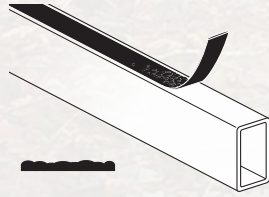

**Part # Length**

BG-045 45"

### Plastic Bar Guard

- › Textured plastic surface
- › Adhesive backing
- › Fitment: ST or SS cross bars
- › Material: Plastic
- › Color: Black

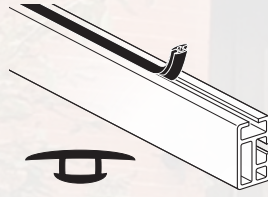

**Part # Length**

BG-537 37"

### Rubber Bar Guard

- › Non-slip rubber surface
- › Press-In installation method
- › Fitment: A613 cross bars
- › Material: Rubber
- › Color: Black

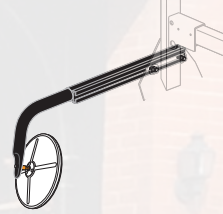

**Part # Adjustment**

A81 25"-32"

### Back-Up 8" Convex Mirror

- › Installs onto eye hooks
- › Material: Aluminum
- › Color: Anodized black



**Part # Length**

WF-47 47"

### Wind Foil

- › Decreases wind noise and vibrations
- › Does not interfere with accessories
- › Material: Aluminum
- › Color: Anodized black  
Powder coated white

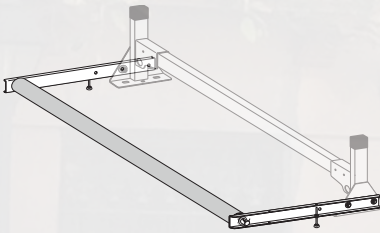

**PART #**

ROH124-47

### Roller Extension

- › Adjustable 16" or 20"
- › Adjustable riser for added support
- › Material: Aluminum
- › Color: Anodized black  
Anodized silver  
Powder coated white
- › Roller only available in silver

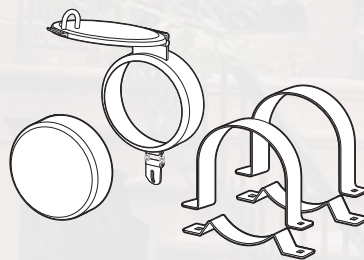

**PART #**

A40

- › 6" Conduit Hatch & Cap
- › No drilling required.
- › Includes: Cross bar clamps
- › Material: Aluminum
- › Color: Anodized black  
Anodized silver  
Powder coated white

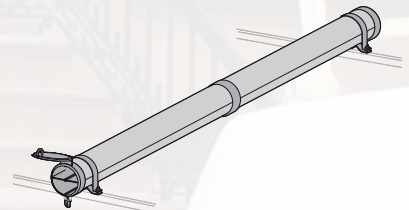

**Part # Description**

CC-104 2 Compartment

### 6" x 128" Conduit Carrier Kit

- › 3 or 4 compartments available (see page 110)
- › Material: Aluminum
- › Color: Anodized black  
Anodized silver  
Powder coated white
- › Tube only available in silver

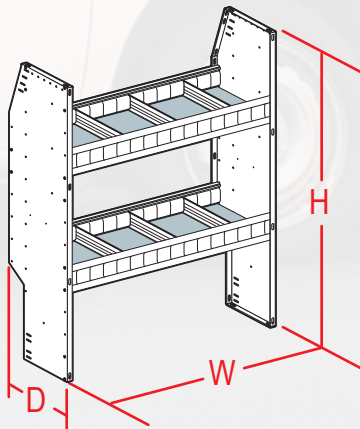

### Aluminum Interior Shelving

- › Fitment: Nissan NV200  
Chevy City Express
- › Material: Aluminum
- › Levels: 2
- › Color: Silver

Depth	Height	36"	42"	48"	60"
11"	46"	SA4636-2	SA4642-2	SA4648-2	SA4660-2

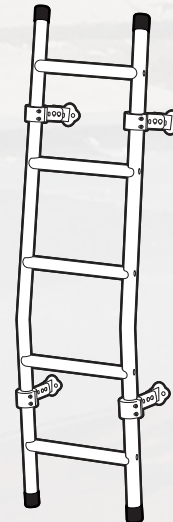

### Rear Access Ladder

- › Fitment: Nissan NV200  
Chevy Express City
- › Material: Aluminum
- › Color: Anodized black  
Anodized silver  
Powder coated white

**Part # Height**

L001 56"

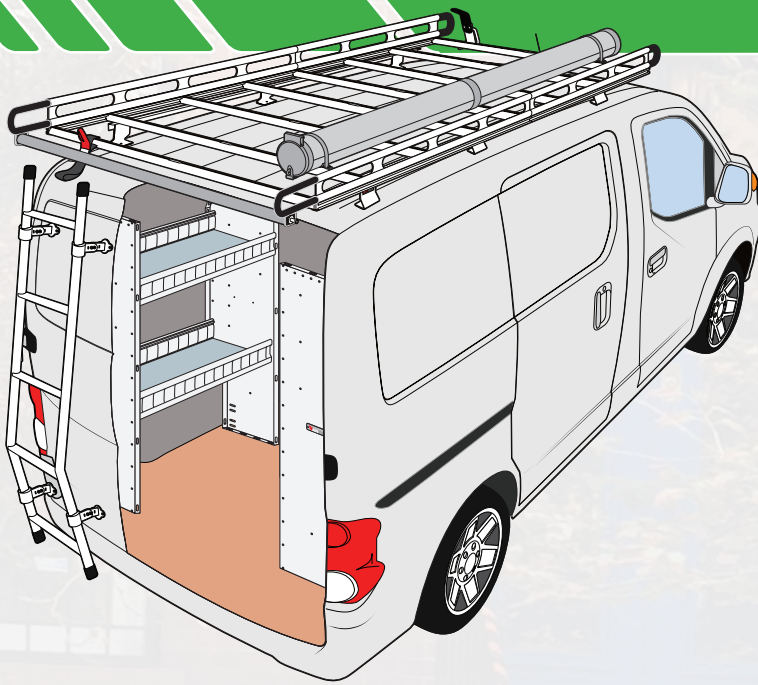

## H2 RACK SYSTEM

- › Fastens onto existing factory mounting points
- › Fits all models
- › All aluminum design
- › Multiple cross bars at 16" apart
- › 2.25" x 1" x 50" cross bars
- › Built-in channels on the cargo rails and cross bars for additional accessories
- › Cargo rail length 96"
- › Rear adjustable roller allows for easy loading and unloading
- › Roller can extend beyond the edge of the roof
- › Colors available: black, white or silver

### H2 Rack System

### Description

### Cross Bar

### Color

### Capacity



H2 96" Cargo System

50"

B / W / S

600 lbs.

## H2 Accessories



### Part #

A20

#### Adjustable Guide

- › Height: 5" tall
- › Fitment: Cross bars with channels
- › Material: Galvanized steel rubber dipped

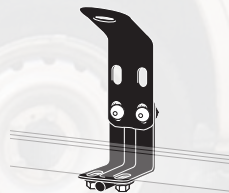

### Part #

A57

#### Ladder Stopper

- › Height: 5-7" tall
- › Material: Galvanized steel rubber dipped
- › Color: Black

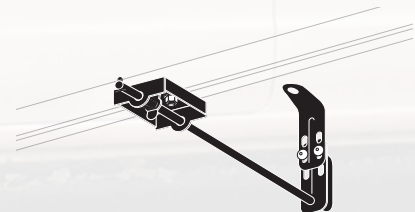

### Part #

A64

#### Push 2 Secure

- › Secure and lock ladder
- › Material: Galvanized steel rubber dipped
- › Color: Black

## H2 Accessories

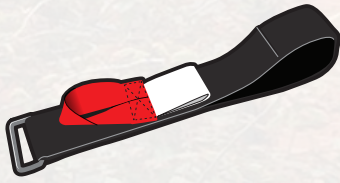

Part #
A69

### EZ Hook and loop fastener Strap

- › Strap loops onto cross bar
- › Capacity: 75 lbs.
- › Fitment: All Vantech cross bars
- › Material: Nylon
- › Color: Black & red



Part #	Size
A24	1"
A59	1.25"

### Eye hook

- › Fitment: Slides into aluminum channels
- › Material: Stainless steel
- › Color: Silver

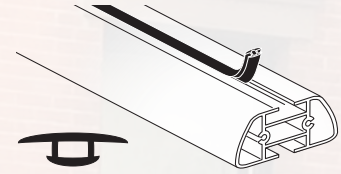

Part #	Length
BG-559	59"

### Rubber Bar Guard

- › Non-slip rubber surface
- › Press-In installation method
- › Fitment: A285 cross bars
- › Material: Rubber
- › Color: Black

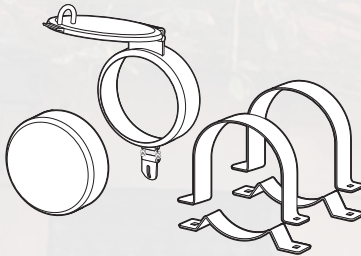

PART #
A34

### 6" Conduit Carrier Hatch & Cap

- › No drilling required
- › Secures to bars with sliders.
- › Material: Aluminum
- › Color: Anodized black  
Anodized silver  
Powder coated white

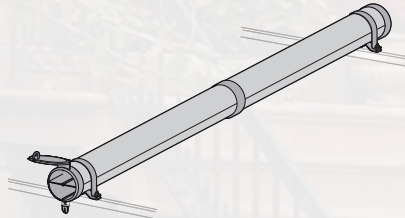

Part #	Description
CC-101	2 Compartment

### 6" x 128" Conduit Carrier Kit

- › 3 or 4 compartments available (see page 110)
- › Material: Aluminum
- › Color: Anodized black  
Anodized silver  
Powder coated white
- › Tube only available in silver

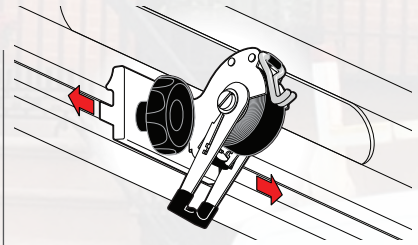

Part #
RTD10-H2

- › Ratchet Tie-Down
- › Bolt-on system (no drilling required)
- › Self contained strap
- › Strap: 1.5" x 120"
- › Material: Stainless steel/Aluminum

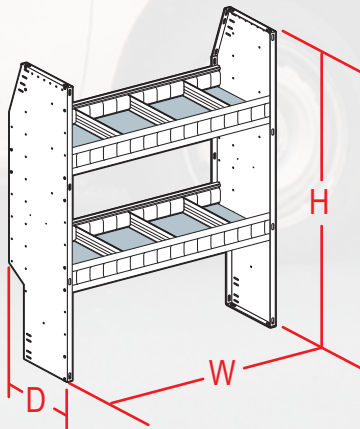

### Aluminum Interior Shelving

- › Fitment: Nissan NV200  
Chevy City Express
- › Material: Aluminum
- › Levels: 2
- › Color: Silver

Depth	Height	36"	42"	48"	60"
11"	46"	SA4636-2	SA4642-2	SA4648-2	SA4660-2

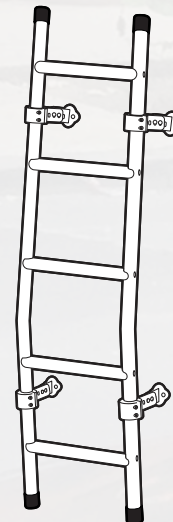

### Rear Access Ladder

- › Fitment: Nissan NV200  
Chevy Express City
- › Material: Aluminum
- › Color: Anodized black  
Anodized silver  
Powder coated white

Part #	Height
L001	56"



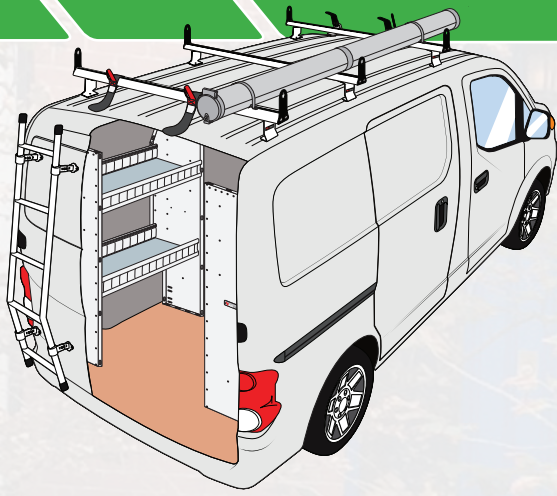

## J SERIES RACK SYSTEM

- › Fasten onto existing factory mounting points
- › Fits all models
- › 2.25" x 1" or 3" x 1.5" cross bars available
- › All aluminum design
- › 2.75" wide mounting bases
- › Heavy duty 1/8" thick mounting bases
- › Built-in channels on the cross bars for additional accessories
- › Colors available: black, white or silver

J series Rack System	Description	Vehicle	Cross Bar	Bar Type	Color	Capacity
	J1000 2 Bar System (Bolt-On)	Nissan NV200	50"	A285	B / W / S	400 lbs.
		Chevy Express City	50"	A285	B / W / S	400 lbs.
		Nissan NV200	55"	A286	B / W / S	500 lbs.
		Chevy Express City	55"	A286	B / W / S	500 lbs.
	J1000 3 Bar System (Bolt-On)	Nissan NV200	50"	A285	B / W / S	600 lbs.
		Chevy Express City	50"	A285	B / W / S	600 lbs.
		Nissan NV200	55"	A286	B / W / S	750 lbs.
		Chevy Express City	55"	A286	B / W / S	750 lbs.
	J2000 2 Bar System (Bolt-On) Included acc. 4 x Side Support 1 x Ladder Stopper 1 x EZ Hook and loop fastener Strap	Nissan NV200	50"	A285	B / W / S	400 lbs.
		Chevy Express City	50"	A285	B / W / S	400 lbs.
		Nissan NV200	55"	A286	B / W / S	500 lbs.
		Chevy Express City	55"	A286	B / W / S	500 lbs.
	J2000 3 Bar System (Bolt-On) Included acc. 6 x Side Support 2 x Ladder Stopper 2 x EZ Hook and loop fastener Strap	Nissan NV200	50"	A285	B / W / S	600 lbs.
		Chevy Express City	50"	A285	B / W / S	600 lbs.
		Nissan NV200	55"	A286	B / W / S	750 lbs.
		Chevy Express City	55"	A286	B / W / S	750 lbs.

## J series Accessories

<b>Part #</b>	<b>Part #</b>	<b>Part #</b>	<b>Part #</b>
A03 / A04	A20	A57	A64
<b>Side Support</b>	<b>Adjustable Guide</b>	<b>Ladder Stopper</b>	<b>Push 2 Secure</b>
› Height : 4" tall from top of cross bar	› Height: 5" tall	› Height: 5-7" tall	› Secure and lock ladder
› Fitment: A03 fits A286 cross bars A04 fits A285 cross bars	› Fitment: Cross bars with channels	› Material: Galvanized steel rubber dipped	› Material: Galvanized steel rubber dipped
› Material: Galvanized steel rubber dipped	› Material: Galvanized steel rubber dipped	› Color: Black	› Color: Black

## J series Accessories

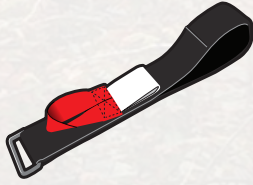

**Part #**

A69

**EZ Hook and loop fastener Strap**

- › Strap loops onto cross bar
- › Capacity: 75 lbs.
- › Fitment: All Vantech cross bars
- › Material: Nylon
- › Color: Black & red

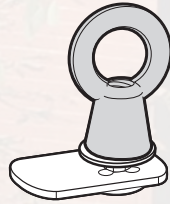

**Part # Size**

A24 1"  
A59 1.25"

**1" Eye hook**

- › Fitment: Slides into aluminum channels
- › Material: Stainless steel
- › Color: Silver

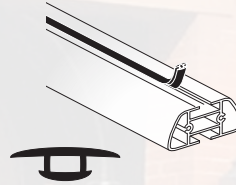

**Part # Length**

BG-550 50"  
BG-555 55"

**Rubber Bar Guard**

- › Non-slip rubber surface
- › Press-In installation method
- › Fitment: A285 / A286 cross bars
- › Material: Rubber
- › Color: Black

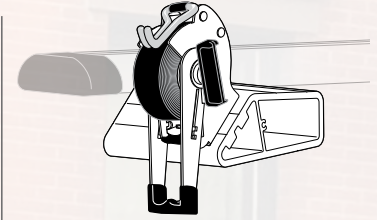

**Part #**

RTD10-H3

**› Ratchet Tie-Down**

- › Bolt-on system (no drilling required)
- › Self contained strap
- › Strap: 1.5" x 120"
- › Material: Stainless steel/Aluminum

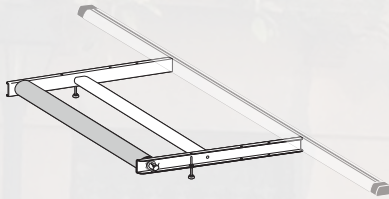

**PART #**

ROH324-36

**Roller Extension**

- › Adjustable 10" - 20"
- › Fitment: A285/A286 cross bars
- › Material: Aluminum
- › Color: Anodized black  
Anodized silver  
Powder coated white
- › Roller only available in silver

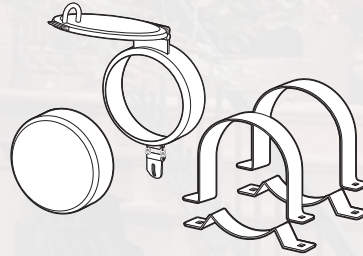

**PART #**

A34

**6" Conduit Hatch & Cap**

- › No drilling required
- › Secures to bars with sliders
- › Material: Aluminum
- › Color: Anodized black  
Anodized silver  
Powder coated white

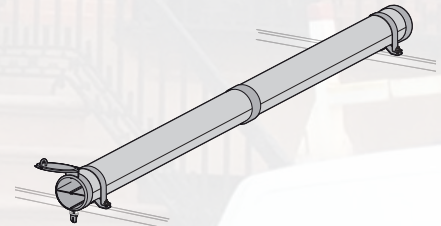

**Part # Description**

CC-101 2 Compartment

**6" x 128" Conduit Carrier Kit**

- › 3 or 4 compartments available (see page 110)
- › Material: Aluminum
- › Color: Anodized black  
Anodized silver  
Powder coated white
- › Tube only available in silver

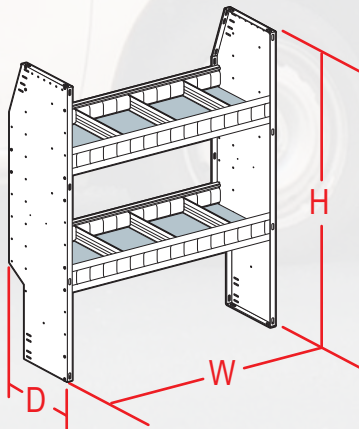

**Aluminum Interior Shelving**

- › Fitment: Nissan NV200  
Chevy City Express
- › Material: Aluminum
- › Levels: 2
- › Color: Silver

Depth	Height	36"	42"	48"	60"
11"	46"	SA4636-2	SA4642-2	SA4648-2	SA4660-2

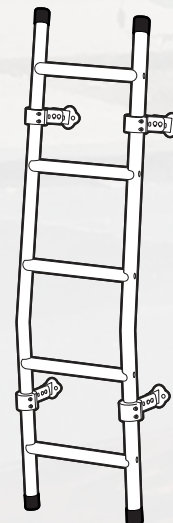

**Rear Access Ladder**

- › Fitment: Nissan NV200  
Chevy Express City
- › Material: Aluminum
- › Color: Anodized black  
Anodized silver  
Powder coated white

**Part # Height**

L001 56"

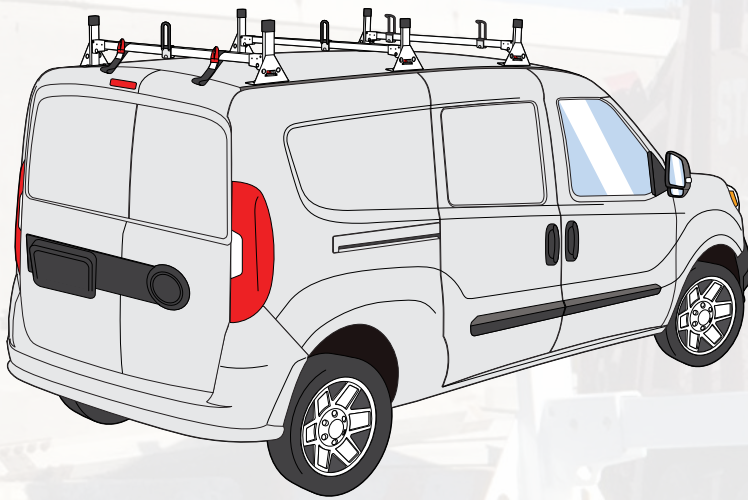

## H1 RACK SYSTEM

- › Fastens onto existing factory mounting points
- › Fits all models
- › 45" wide loading area
- › Low profile 10.5" total clearance
- › 4 x .75" eyehooks per mounting base for easy tie down
- › Materials available: steel, aluminum or stainless steel
- › Colors available: black, white or silver

### STEEL SYSTEM

- › Heavy duty grade
- › Economical
- › Rust free
- › Stainless steel hardware
- › Lightweight

### STAINLESS STEEL SYSTEM

- › Rust free
- › Stainless steel hardware
- › Longer lasting durability

### ALUMINUM SYSTEM

(more info see page 3)

H1 Rack System	Description	Material	Color	Capacity
	2 Bar System (Bolt-On)	ST	B / W	500 lbs.
	Included acc. 1 x Ladder Stopper 1 x Ladder Guide	AL	B / W / S	500 lbs.
		SS	SS	600 lbs.
	3 Bar System (Bolt-On)	ST	B / W	750 lbs.
	Included acc. 2 x Ladder Stopper 2 x Ladder Guide	AL	B / W / S	750 lbs.
	Hook and loop fastener Strap	SS	SS	900 lbs.

## H1 Accessories



Part #

A69

### EZ Hook and loop fastener Strap

- › Strap loops onto cross bar
- › Capacity: 75 lbs.
- › Fitment: All Vantech cross bars
- › Material: Nylon
- › Color: Black & red



Part #

A02

### Ladder Guide

- › Height: 5.5" tall
- › Fitment: H series (1" x 2")
- › Material: Galvanized steel
- › Finish: Black rubber



Part #

A06

### Ladder Stopper

- › Height: 5" tall
- › Fitment: H series (1" x 2")
- › Material: Galvanized steel
- › Finish: Black rubber

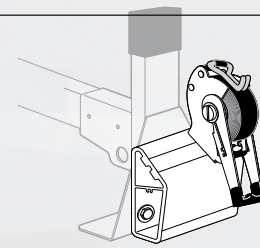

Part #

RTD10-H1

### Ratchet Tie-Down

- › Bolt-on system (no drilling required)
- › Self contained strap
- › Strap: 1.5" x 120"
- › Material: Stainless steel/Aluminum

## H1 Accessories

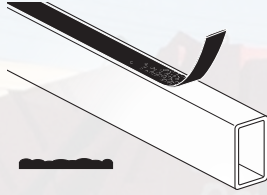

Part #	Length
BG-045	45"

### Plastic Bar Guard

- Textured plastic surface
- Adhesive backing
- Fitment: ST or SS cross bars
- Material: Plastic
- Color: Black

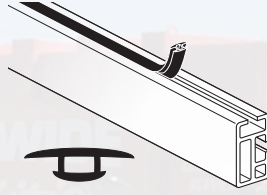

Part #	Length
BG-537	37"

### Rubber Bar Guard

- Non-slip rubber surface
- Press-In installation method
- Fitment: A613 cross bars
- Material: Rubber
- Color: Black

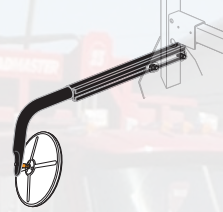

Part #	Adjustment
A81	25"-32"

### Back-Up 8" Convex Mirror

- Installs onto eye hooks
- Material: Aluminum
- Color: Anodized black



Part #	Length
WF-47	47"

### Wind Foil

- Decreases wind noise and vibrations
- Does not interfere with accessories
- Material: Aluminum
- Color: Anodized black  
Powder coated white

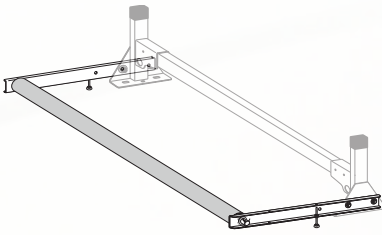

### PART #

ROH124-47

### Roller Extension

- Adjustable 16" or 20"
- Adjustable riser for added support
- Material: Aluminum
- Color: Anodized black  
Anodized silver  
Powder coated white
- Roller only available in silver

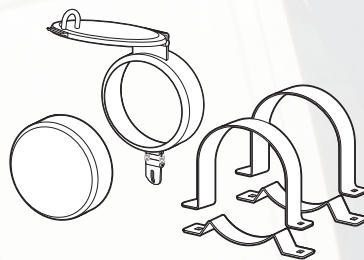

### PART #

A40

- 6" Conduit Hatch & Cap
- No drilling required.
- Includes: Cross bar clamps
- Material: Aluminum
- Color: Anodized black  
Anodized silver  
Powder coated white

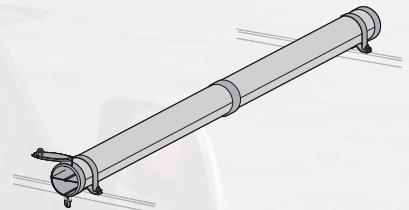

### Part # Description

CC-104 2 Compartment

### 6" x 128" Conduit Carrier Kit

- 3 or 4 compartments available (see page 110)
- Material: Aluminum
- Color: Anodized black  
Anodized silver  
Powder coated white
- Tube only available in silver

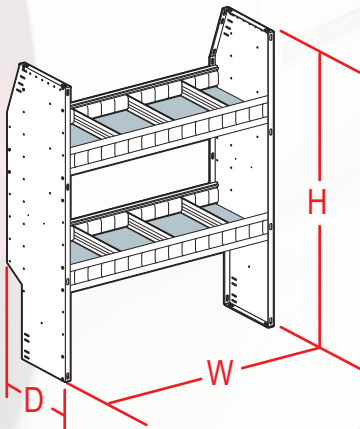

### Aluminum Interior Shelving

- Fitment: RAM ProMaster City
- Material: Aluminum
- Levels: 2
- Color: Silver

Depth	Height	36"	42"	48"	60"
11"	46"	SA4636-2	SA4642-2	SA4648-2	SA4660-2

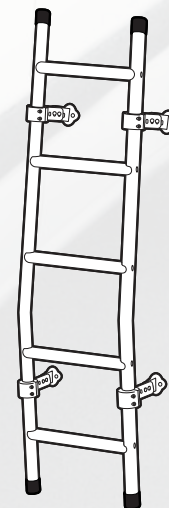

### Rear Access Ladder

- Fitment: RAM ProMaster City
- Material: Aluminum
- Color: Anodized black  
Anodized silver  
Powder coated white

### Part # Height

L001 56"

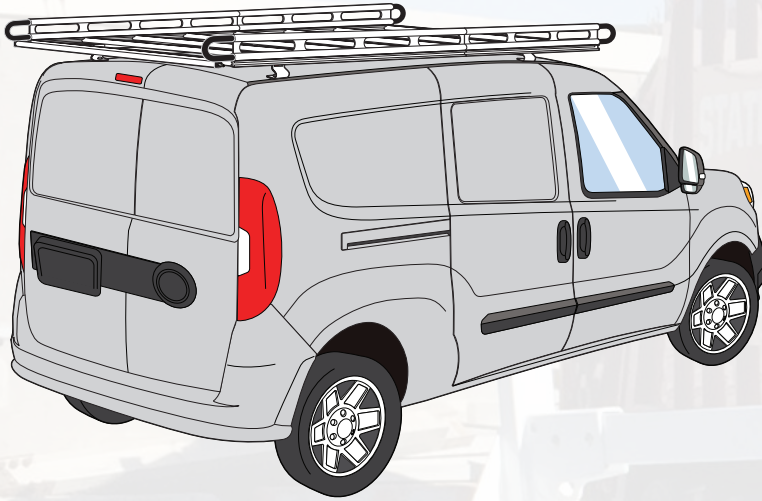

## H2 RACK SYSTEM

- › Fastens onto existing factory mounting points
- › Fits all models
- › All aluminum design
- › Multiple cross bars at 16" apart
- › 2.25" x 1" x 50" cross bars
- › Built-in channels on the cargo rails and cross bars for additional accessories
- › Cargo rail length 96"
- › Rear adjustable roller allows for easy loading and unloading
- › Roller can extend beyond the edge of the roof
- › Colors available: black, white or silver

### H2 Rack System

### Description

### Cross Bar

### Color

### Capacity



H2 96" Cargo System

50"

B / W / S

600 lbs.

## H2 Accessories



### Part #

A20

#### Adjustable Guide

- › Height: 5" tall
- › Fitment: Cross bars with channels
- › Material: Galvanized steel rubber dipped

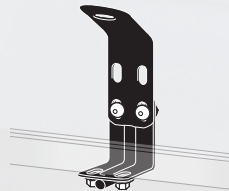

### Part #

A57

#### Ladder Stopper

- › Height: 5-7" tall
- › Material: Galvanized steel rubber dipped
- › Color: Black

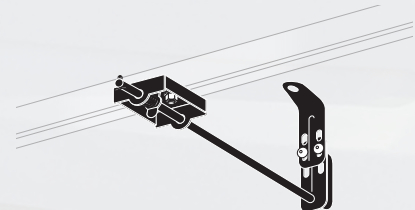

### Part #

A64

#### Push 2 Secure

- › Secure and lock ladder
- › Material: Galvanized steel rubber dipped
- › Color: Black

## H2 Accessories



Part #
A69

### EZ Hook and loop fastener Strap

- › Strap loops onto cross bar
- › Capacity: 75 lbs.
- › Fitment: All Vantech cross bars
- › Material: Nylon
- › Color: Black & red



Part #	Size
A24	1"
A59	1.25"

### Eye hook

- › Fitment: Slides into aluminum channels
- › Material: Stainless steel
- › Color: Silver



Part #	Length
BG-559	59"

### Rubber Bar Guard

- › Non-slip rubber surface
- › Press-In installation method
- › Fitment: A285 cross bars
- › Material: Rubber
- › Color: Black

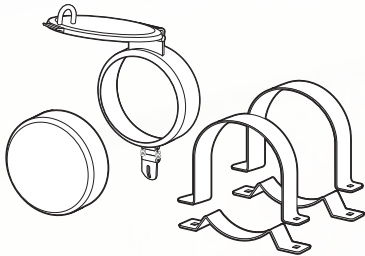

PART #
A34

### 6" Conduit Carrier Hatch & Cap

- › No drilling required
- › Secures to bars with sliders.
- › Material: Aluminum
- › Color: Anodized black  
Anodized silver  
Powder coated white

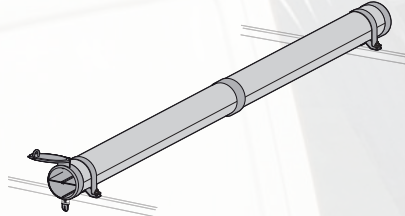

Part #	Description
CC-101	2 Compartment

### 6" x 128" Conduit Carrier Kit

- › 3 or 4 compartments available (see page 110)
- › Material: Aluminum
- › Color: Anodized black  
Anodized silver  
Powder coated white
- › Tube only available in silver

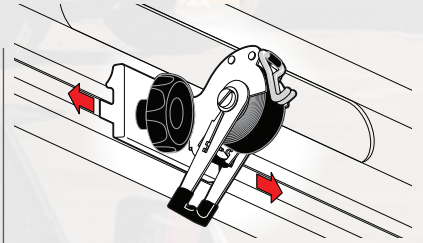

Part #
RTD10-H2

- › Ratchet Tie-Down
- › Bolt-on system (no drilling required)
- › Self contained strap
- › Strap: 1.5" x 120"
- › Material: Stainless steel/Aluminum

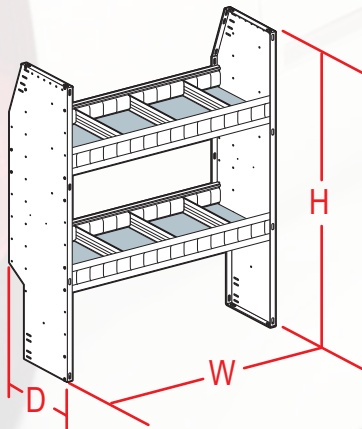

### Aluminum Interior Shelving

- › Fitment: RAM ProMaster City
- › Material: Aluminum
- › Levels: 2
- › Color: Silver

Depth	Height	36"	42"	48"	60"
11"	46"	SA4636-2	SA4642-2	SA4648-2	SA4660-2

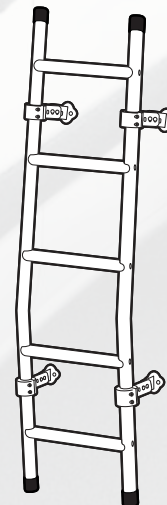

### Rear Access Ladder

- › Fitment: RAM ProMaster City
- › Material: Aluminum
- › Color: Anodized black  
Anodized silver  
Powder coated white

Part #	Height
L001	56"

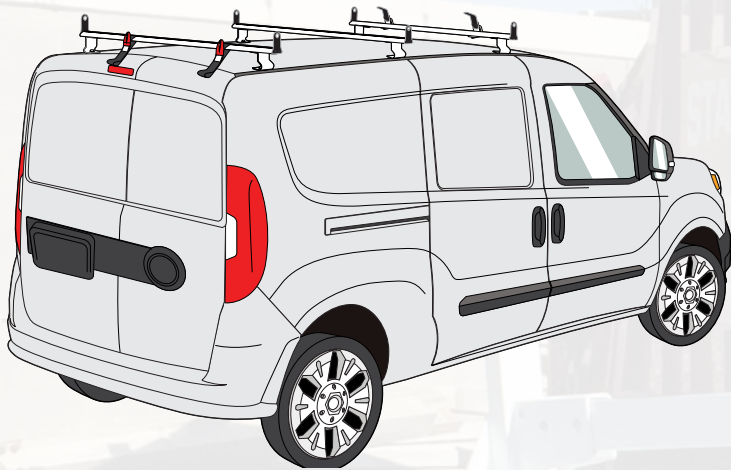

## J SERIES RACK SYSTEM

- › Fastens onto existing factory mounting points
- › Fits all models
- › 2.25" x 1" or 3" x 1.5" cross bars available
- › All aluminum design
- › 2.75" - 4" wide mounting bases
- › Heavy duty 1/8" thick mounting bases
- › Built-in channels on the cross bars for additional accessories
- › Colors available: black, white or silver

J series Rack System	Description	Cross Bar	Material	Bar Type	Color	Capacity
	J1000 2 Bar System (Bolt-On)	50"	Aluminum	A285	B / W / S	400 lbs.
		55"	Aluminum	A286	B / W / S	500 lbs.
	J1000 3 Bar System (Bolt-On)	50"	Aluminum	A285	B / W / S	600 lbs.
		55"	Aluminum	A286	B / W / S	750 lbs.
	J2000 2 Bar System (Bolt-On)	50"	Aluminum	A285	B / W / S	400 lbs.
		55"	Aluminum	A286	B / W / S	500 lbs.
	J2000 3 Bar System (Bolt-On)	50"	Aluminum	A285	B / W / S	600 lbs.
		55"	Aluminum	A286	B / W / S	750 lbs.

Includes:  
4 x Side Support  
1 x Ladder Stopper  
1 x EZ Ladder Stopper

Includes:  
6 x Side Support  
2 x Ladder Stopper  
2 x EZ Ladder Stopper

## J series Accessories

<b>Part #</b>	<b>Part #</b>	<b>Part #</b>	<b>Part #</b>
A03 / A04	A20	A57	A64
<b>Side Support</b>	<b>Adjustable Guide</b>	<b>Ladder Stopper</b>	<b>Push 2 Secure</b>
› Height : 4" tall from top of cross bar	› Height: 5" tall	› Height: 5-7" tall	› Secure and lock ladder
› Fitment: A03 fits A286 cross bars A04 fits A285 cross bars	› Fitment: Cross bars with channels	› Material: Galvanized steel rubber dipped	› Material: Galvanized steel rubber dipped
› Material: Galvanized steel rubber dipped	› Material: Galvanized steel rubber dipped	› Color: Black	› Color: Black

## J series Accessories

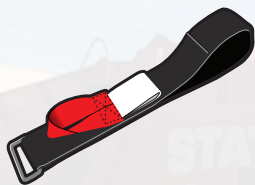

Part #
A69

### EZ Hook and loop fastener Strap

- › Strap loops onto cross bar
- › Capacity: 75 lbs.
- › Fitment: All Vantech cross bars
- › Material: Nylon
- › Color: Black & red

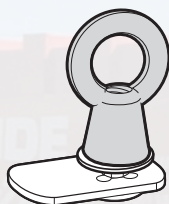

Part #	Size
A24	1"
A59	1.25"

### 1" Eye hook

- › Fitment: Slides into aluminum channels
- › Material: Stainless steel
- › Color: Silver

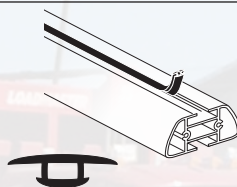

Part #	Length
BG-550	50"
BG-555	55"

### Rubber Bar Guard

- › Non-slip rubber surface
- › Press-In installation method
- › Fitment: A285 / A286 cross bars
- › Material: Rubber
- › Color: Black

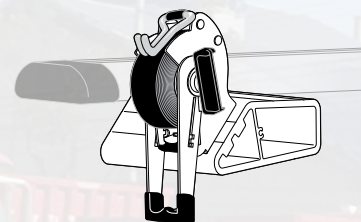

Part #
RTD10-H3

### Ratchet Tie-Down

- › Bolt-on system (no drilling required)
- › Self contained strap
- › Strap: 1.5" x 120"
- › Material: Stainless steel/Aluminum

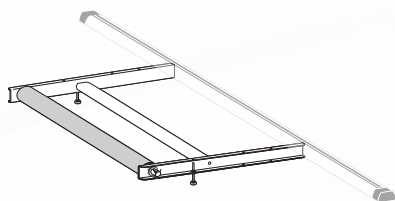

PART #
ROH324-36

### Roller Extension

- › Adjustable 10" - 20"
- › Fitment: A285/A286 cross bars
- › Material: Aluminum
- › Color: Anodized black  
Anodized silver  
Powder coated white
- › Roller only available in silver

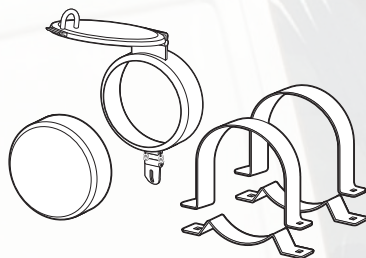

PART #
A34

### 6" Conduit Hatch & Cap

- › No drilling required
- › Secures to bars with sliders
- › Material: Aluminum
- › Color: Anodized black  
Anodized silver  
Powder coated white

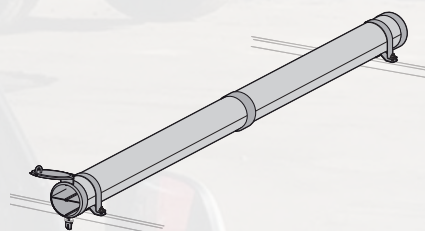

Part #	Description
CC-101	2 Compartment

### 6" x 128" Conduit Carrier Kit

- › 3 or 4 compartments available (see page 110)
- › Material: Aluminum
- › Color: Anodized black  
Anodized silver  
Powder coated white
- › Tube only available in silver

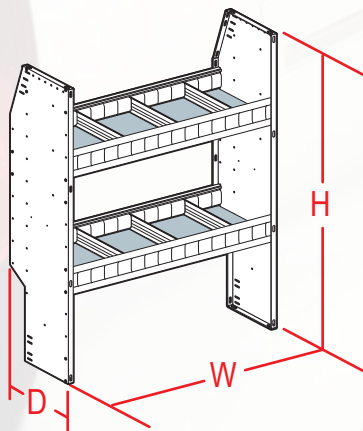

Depth	Height	36"	42"	48"	60"
11"	46"	SA4636-2	SA4642-2	SA4648-2	SA4660-2

### Aluminum Interior Shelving

- › Fitment: RAM ProMaster City
- › Material: Aluminum
- › Levels: 2
- › Color: Silver

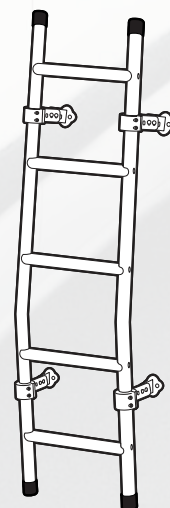

### Rear Access Ladder

- › Fitment: RAM ProMaster City
- › Material: Aluminum
- › Color: Anodized black  
Anodized silver  
Powder coated white

Part #	Height
L001	56"



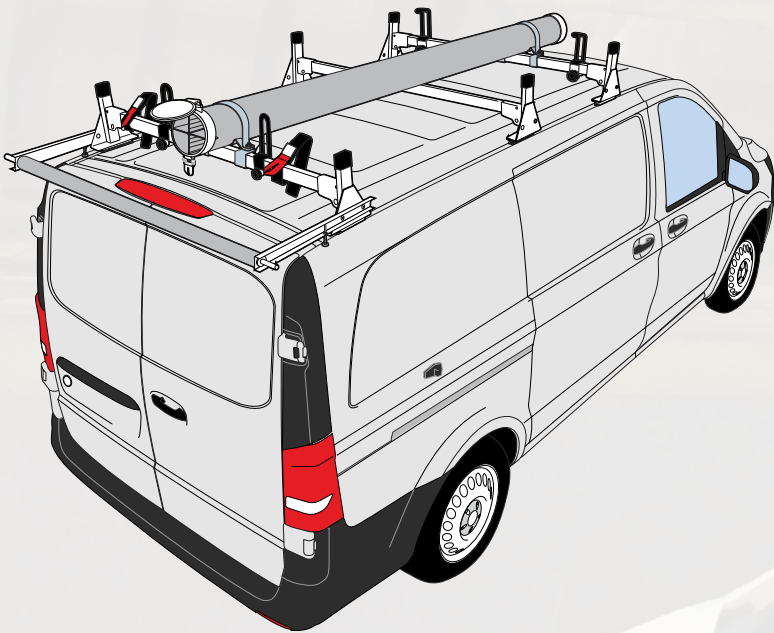

## H1 RACK SYSTEM

- › Fastens onto existing factory mounting points
- › Fits all models
- › 45" wide loading area
- › Low profile 10.5" total clearance
- › 4 x .75" eyehooks per mounting base for easy tie down
- › Materials available: steel, aluminum or stainless steel
- › Colors available: black, white or silver

### STEEL SYSTEM

- › Heavy duty grade
- › Economical



### ALUMINUM SYSTEM

- › Rust free
- › Stainless steel hardware
- › Lightweight

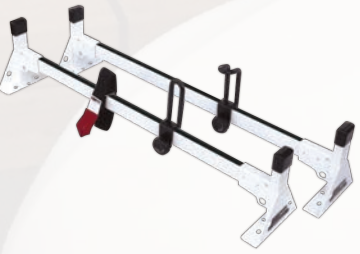

### STAINLESS STEEL SYSTEM

- › Rust free
- › Stainless steel hardware
- › Longer lasting durability

(more info see page 3)

H1 Rack System	Description	Material	Color	Capacity
	2 Bar System (Bolt-On)	ST	B / W	500 lbs.
	Included acc. 1 x Ladder Stopper 1 x Ladder Guide 1 x EZ Hook and loop fastener Strap	AL	B / W / S	500 lbs.
		SS	SS	600 lbs.
	3 Bar System (Bolt-On)	ST	B / W	750 lbs.
	Included acc. 2 x Ladder Stopper 2 x Ladder Guide 2 x EZ Hook and loop fastener Strap	AL	B / W / S	750 lbs.
		SS	SS	900 lbs.

## H1 Accessories

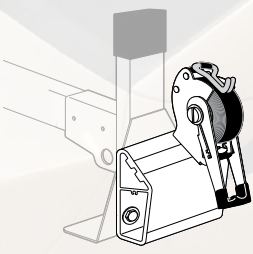
			
<b>Part #</b>	<b>Part #</b>	<b>Part #</b>	<b>Part #</b>
A69	A02	A06	RTD10-H1
<b>EZ Hook and loop fastener Strap</b>	<b>Ladder Guide</b>	<b>Ladder Stopper</b>	<b>Ratchet Tie-Down</b>
› Strap loops onto cross bar	› Height: 5.5" tall	› Height: 5" tall	› Bolt-on system (no drilling required)
› Capacity: 75 lbs.	› Fitment: H series (1" x 2")	› Fitment: H series (1" x 2")	› Self contained strap
› Fitment: All Vantech cross bars	› Material: Galvanized steel	› Material: Galvanized steel	› Strap: 1.5" x 120"
› Material: Nylon	› Finish: Black rubber	› Finish: Black rubber	› Material: Stainless steel/Aluminum
› Color: Black & red			

## H1 Accessories



**Part #**

BG-0\_\_

**Plastic Bar Guard**

- › Textured plastic surface
- › Adhesive backing
- › Fitment: ST or SS cross bars
- › Material: Plastic
- › Color: Black



**Part #**

BG-5\_\_

**Rubber Bar Guard**

- › Non-slip rubber surface
- › Press-In installation method
- › Fitment: A613 cross bars
- › Material: Rubber
- › Color: Black



**Part # Adjustment**

A81 25"-32"

**Back-Up 8" Convex Mirror**

- › Installs onto eye hooks
- › Material: Aluminum
- › Color: Anodized black



**Part # Length**

WF-47 47"

**Wind Foil**

- › Decreases wind noise and vibrations
- › Does not interfere with accessories
- › Material: Aluminum
- › Color: Anodized black  
Powder coated white

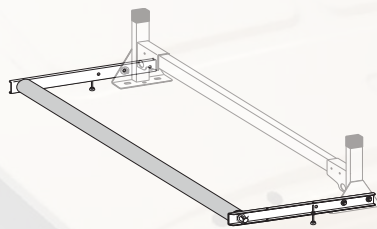

**PART #**

ROH124-53

**Roller Extension**

- › Adjustable 16" or 20"
- › Adjustable riser for added support
- › Material: Aluminum
- › Color: Anodized black  
Anodized silver  
Powder coated white
- › Roller only available in silver

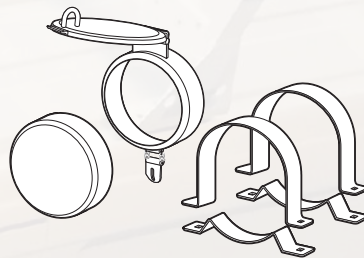

**PART #**

A40

- › **6" Conduit Hatch & Cap**
- › No drilling required.
- › Includes: Cross bar clamps
- › Material: Aluminum
- › Color: Anodized black  
Anodized silver  
Powder coated white

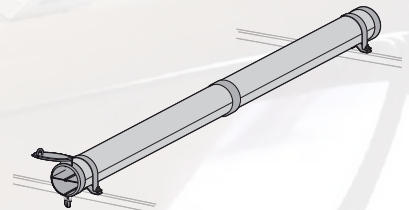

**Part # Description**

CC-104 2 Compartment

**6" x 128" Conduit Carrier Kit**

- › 3 or 4 compartments available (see page 110)
- › Material: Aluminum
- › Color: Anodized black  
Anodized silver  
Powder coated white
- › Tube only available in silver

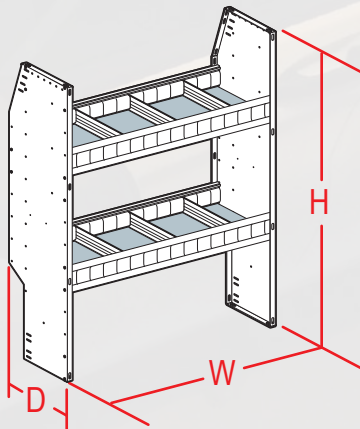

**Aluminum Interior Shelving**

- › Fitment: Mercedes Benz Metris
- › Material: Aluminum
- › Levels: 2
- › Color: Silver

Depth	Height	36"	42"	48"	60"
11"	46"	SA4636-2	SA4642-2	SA4648-2	SA4660-2

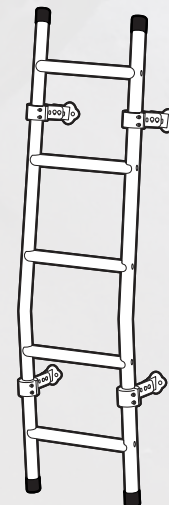

**Rear Access Ladder**

- › Fitment: Mercedes Benz Metris
- › Material: Aluminum
- › Color: Anodized black  
Anodized silver  
Powder coated white

**Part # Height**

L001 56"

## H2 RACK SYSTEM

- › Fastens onto existing factory mounting points
- › Fits all models
- › All aluminum design
- › Multiple cross bars at 16" apart
- › 2.25" x 1" x 50" cross bars
- › Built-in channels on the cargo rails and cross bars for additional accessories
- › Cargo rail length 96"
- › Rear adjustable roller allows for easy loading and unloading
- › Roller can extend beyond the edge of the roof
- › Colors available: black, white or silver



H2 Rack System

Description

Cross Bar

Color

Capacity



H2 96" Cargo System

50"

B / W / S

600 lbs.

## H2 Accessories



Part #

A20

### Adjustable Guide

- › Height: 5" tall
- › Fitment: Cross bars with channels
- › Material: Galvanized steel rubber dipped

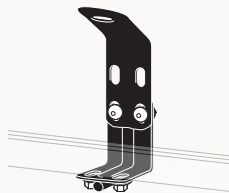

Part #

A57

### Ladder Stopper

- › Height: 5-7" tall
- › Material: Galvanized steel rubber dipped
- › Color: Black

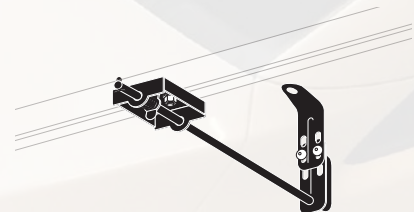

Part #

A64

### Push 2 Secure

- › Secure and lock ladder
- › Material: Galvanized steel rubber dipped
- › Color: Black

## H2 Accessories



**Part #**

A69

**EZ Hook and loop fastener Strap**

- › Strap loops onto cross bar
- › Capacity: 75 lbs.
- › Fitment: All Vantech cross bars
- › Material: Nylon
- › Color: Black & red



**Part #      Size**

A24      1"  
A59      1.25"

**Eye hook**

- › Fitment: Slides into aluminum channels
- › Material: Stainless steel
- › Color: Silver

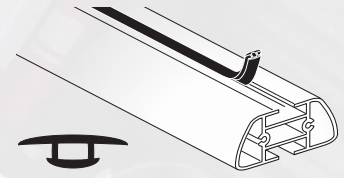

**Part #**

BG-5

**Rubber Bar Guard**

- › Non-slip rubber surface
- › Press-In installation method
- › Fitment: A285 cross bars
- › Material: Rubber
- › Color: Black

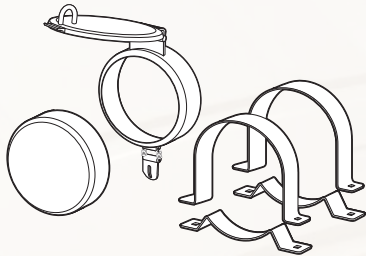

**PART #**

A34

**6" Conduit Carrier Hatch & Cap**

- › No drilling required
- › Secures to bars with sliders.
- › Material: Aluminum
- › Color: Anodized black  
Anodized silver  
Powder coated white

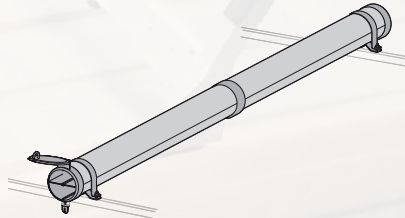

**Part #      Description**

CC-101      2 Compartment

**6" x 128" Conduit Carrier Kit**

- › 3 or 4 compartments available (see page 110)
- › Material: Aluminum
- › Color: Anodized black  
Anodized silver  
Powder coated white
- › Tube only available in silver

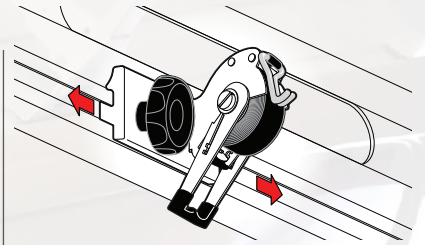

**Part #**

RTD10-H2

- › **Ratchet Tie-Down**
- › Bolt-on system (no drilling required)
- › Self contained strap
- › Strap: 1.5" x 120"
- › Material: Stainless steel/Aluminum

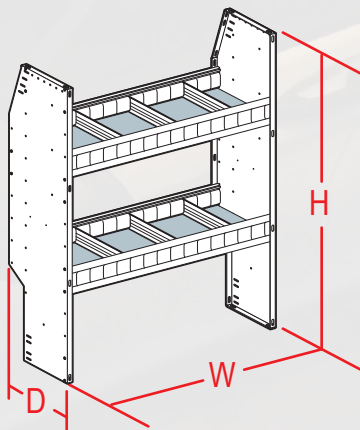

**Aluminum Interior Shelving**

- › Fitment: Mercedes Benz Metris
- › Material: Aluminum
- › Levels: 2
- › Color: Silver

Depth	Height	36"	42"	48"	60"
11"	46"	SA4636-2	SA4642-2	SA4648-2	SA4660-2

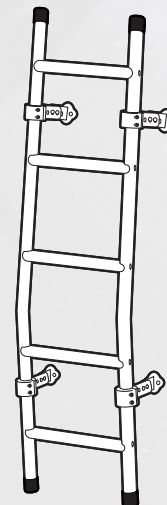

**Rear Access Ladder**

- › Fitment: Mercedes Benz Metris
- › Material: Aluminum
- › Color: Anodized black  
Anodized silver  
Powder coated white



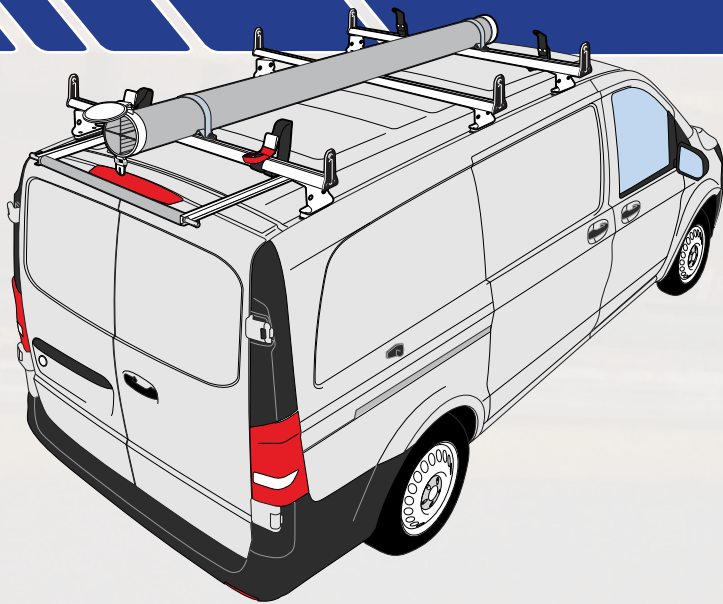

**Part #      Height**

L001      56"

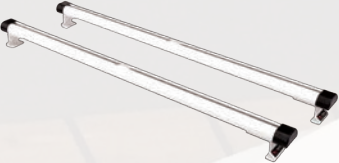

## J SERIES RACK SYSTEM

- › Fastens onto existing factory mounting points
- › Fits all models
- › 3" x 1.5" cross bars available
- › All aluminum design
- › 2.75" - 4" wide mounting bases
- › Heavy duty 1/8" thick mounting bases
- › Built-in channels on the cross bars for additional accessories
- › Colors available: black, white or silver

J series Rack System	Description	Cross Bar	Material	Color	Capacity
	J1000 2 Bar System	55"	Aluminum	B / W / S	500 lbs.
	J1000 3 Bar System	55"	Aluminum	B / W / S	750 lbs.
	J2000 2 Bar System Includes: 4 x Side Support 1 x Ladder Stopper 1 x EZ Ladder Stopper	55"	Aluminum	B / W / S	500 lbs.
	J2000 3 Bar System Includes: 6 x Side Support 2 x Ladder Stopper 2 x EZ Ladder Stopper	55"	Aluminum	B / W / S	750 lbs.

## H3 Accessories

			
<b>Part #</b> A03	<b>Part #</b> A20	<b>Part #</b> A57	<b>Part #</b> A64
<b>Side Support</b> › Height : 4" tall from top of cross bar › Fitment: A03 fits A286 cross bars › Material: Galvanized steel rubber dipped	<b>Adjustable Guide</b> › Height: 5" tall › Fitment: Cross bars with channels › Material: Galvanized steel rubber dipped	<b>Ladder Stopper</b> › Height: 5-7" tall › Material: Galvanized steel rubber dipped › Color: Black	<b>Push 2 Secure</b> › Secure and lock ladder › Material: Galvanized steel rubber dipped › Color: Black

## H3 Accessories

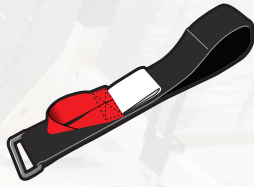

**Part #**

A69

**EZ Hook and loop fastener Strap**

- › Strap loops onto cross bar
- › Capacity: 75 lbs.
- › Fitment: All Vantech cross bars
- › Material: Nylon
- › Color: Black & red



**Part # Size**

A24

1"

A59

1.25"

**1" Eye hook**

- › Fitment: Slides into aluminum channels
- › Material: Stainless steel
- › Color: Silver

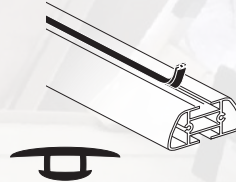

**Part #**

BG-555

**Rubber Bar Guard**

- › Non-slip rubber surface
- › Press-In installation method
- › Fitment: A286 cross bars
- › Material: Rubber
- › Color: Black

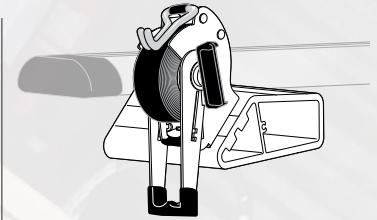

**Part #**

RTD10-H3

**› Ratchet Tie-Down**

- › Bolt-on system (no drilling required)
- › Self contained strap
- › Strap: 1.5" x 120"
- › Material: Stainless steel/Aluminum

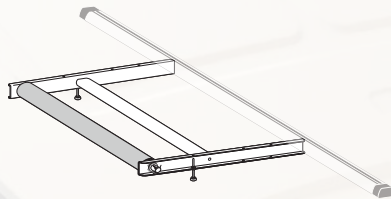

**PART #**

ROH324-36

**Roller Extension**

- › Adjustable 10" - 20"
- › Fitment: A285/A286 cross bars
- › Material: Aluminum
- › Color: Anodized black  
Anodized silver  
Powder coated white
- › Roller only available in silver

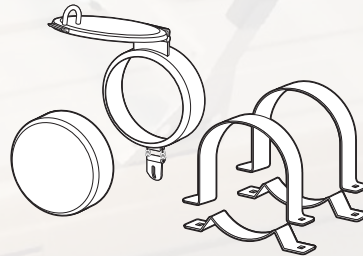

**PART #**

A34

**6" Conduit Hatch & Cap**

- › No drilling required
- › Secures to bars with sliders
- › Material: Aluminum
- › Color: Anodized black  
Anodized silver  
Powder coated white

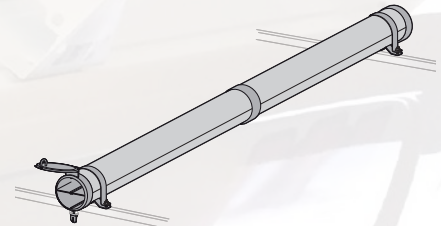

**Part # Description**

CC-101 2 Compartment

**6" x 128" Conduit Carrier Kit**

- › 3 or 4 compartments available (see page 110)
- › Material: Aluminum
- › Color: Anodized black  
Anodized silver  
Powder coated white
- › Tube only available in silver

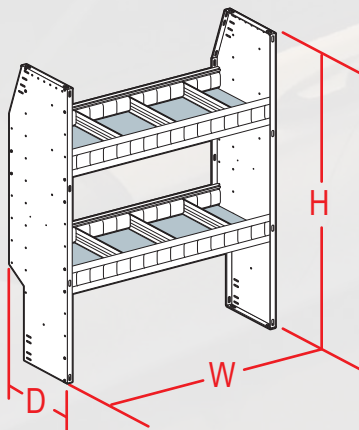

**Aluminum Interior Shelving**

- › Fitment: Mercedes Benz Metris
- › Material: Aluminum
- › Levels: 2
- › Color: Silver

Depth	Height	36"	42"	48"	60"
11"	46"	SA4636-2	SA4642-2	SA4648-2	SA4660-2

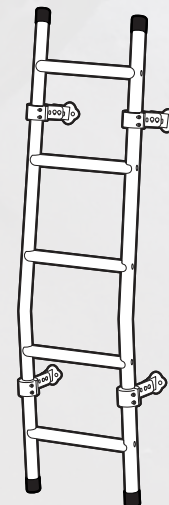

**Rear Access Ladder**

- › Fitment: Mercedes Benz Metris
- › Material: Aluminum
- › Color: Anodized black  
Anodized silver  
Powder coated white

Part #	Height	MSRP
L001	56"	

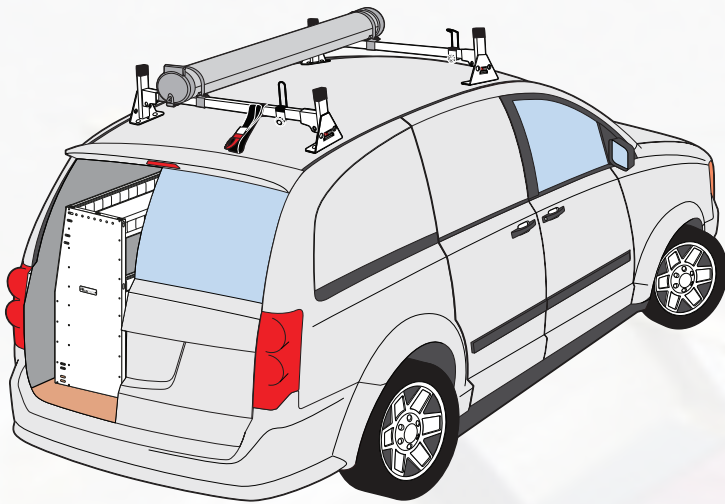

## H1 RACK SYSTEM

- › Bolts onto aluminum or steel body
- › Drilling required
- › All hardware and interior plates included
- › Cross bars from 42" - 56" length
- › Low profile 10.5" total clearance
- › 4 x .75" eyehooks per mounting base for easy tie down
- › Materials available: steel, aluminum or stainless steel
- › Colors available: black, white or silver

### STEEL SYSTEM

- › Heavy duty grade
- › Economical
- › Rust free
- › Stainless steel hardware
- › Lightweight

### STAINLESS STEEL SYSTEM

- › Rust free
- › Stainless steel hardware
- › Longer lasting durability

### ALUMINUM SYSTEM

(more info see page 3)

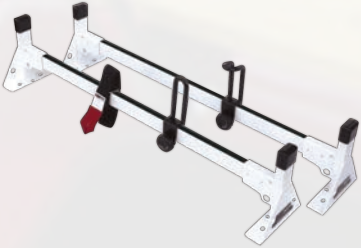
H1 Rack System	Description	Bar Length	Material	Color	Capacity
	2 Bar System  Included acc. 1 x Ladder Stopper 1 x Ladder Guide 1 x EZ Hook and loop fastener Strap	42"	ST	B / W	500 lbs.
			AL	B / W / S	500 lbs.
		SS	SS	600 lbs.	
		ST	B / W	500 lbs.	
		56"	AL	B / W / S	500 lbs.
			SS	SS	600 lbs.

## H1 Accessories

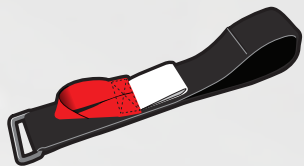

Part #

A69

### EZ Hook and loop fastener Strap

- › Strap loops onto cross bar
- › Capacity: 75 lbs.
- › Fitment: All Vantech cross bars
- › Material: Nylon
- › Color: Black & red



Part #

A02

### Ladder Guide

- › Height: 5.5" tall
- › Fitment: H series (1" x 2")
- › Material: Galvanized steel
- › Finish: Black rubber



Part #

A06

### Ladder Stopper

- › Height: 5" tall
- › Fitment: H series (1" x 2")
- › Material: Galvanized steel
- › Finish: Black rubber

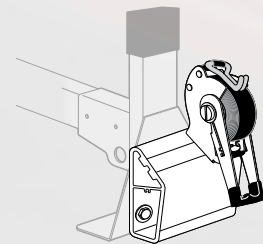

Part #

RTD10-H1

### Ratchet Tie-Down

- › Bolt-on system (no drilling required)
- › Self contained strap
- › Strap: 1.5" x 120"
- › Material: Stainless steel/Aluminum

## H1 Accessories

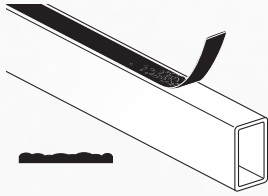

Part #	Length
BG-042	42"
BG-056	56"

### Plastic Bar Guard

- › Textured plastic surface
- › Adhesive backing
- › Fitment: ST or SS cross bars
- › Material: Plastic
- › Color: Black

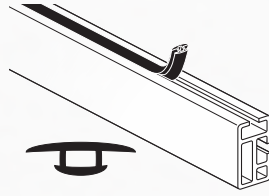

Part #	Length
BG-534	34"
BG-548	48"

### Rubber Bar Guard

- › Non-slip rubber surface
- › Press-In installation method
- › Fitment: A613 cross bars
- › Material: Rubber
- › Color: Black

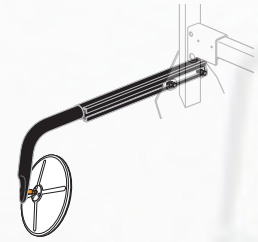

Part #	Adjustment
A81	25"-32"

### Back-Up 8" Convex Mirror

- › Installs onto eye hooks
- › Material: Aluminum
- › Color: Anodized black

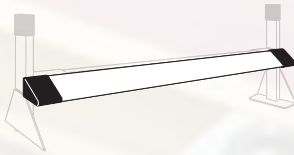

Part #	Length
WF-42	42"
WF-56	56"

### Wind Foil

- › Decreases wind noise and vibrations
- › Does not interfere with accessories
- › Material: Aluminum
- › Color: Anodized black  
Powder coated white

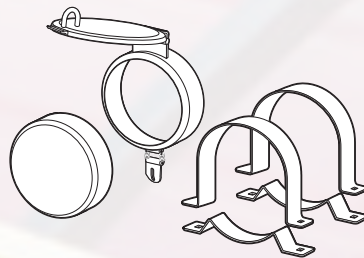

PART #
A40

- › **6" Conduit Hatch & Cap**
- › No drilling required.
- › Includes: Cross bar clamps
- › Material: Aluminum
- › Color: Anodized black  
Anodized silver  
Powder coated white

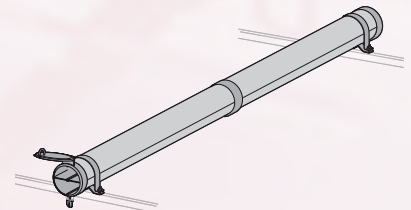

Part #	Description
CC-104	2 Compartment

### 6" x 128" Conduit Carrier Kit

- › 3 or 4 compartments available (see page 110)
- › Material: Aluminum
- › Color: Anodized black  
Anodized silver  
Powder coated white
- › Tube only available in silver

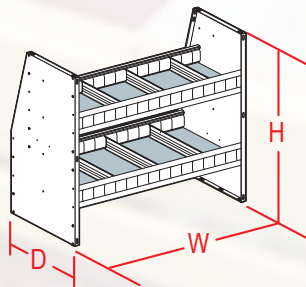

Height	Depth	36"	42"	48"
36"	11"	SA3636-2	SA3642-2	SA3648-2 (

### (Aluminum Interior Shelving

- › Fitment: Mini vans/ hatchback with 36" clearance
- › Material: Aluminum
- › Color: Silver

Vehicle's roof top

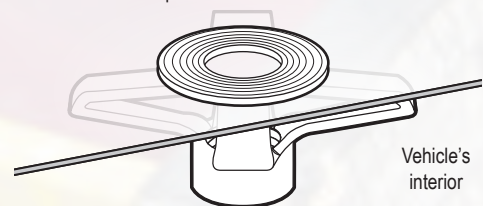

Vehicle's interior

Part #
K059

### Anchor kit (Plus nut)



- › Install without removing upholstery
- › Qty: Pack of 8
- › Material: Zinc plated steel
- › More options on pg. 107

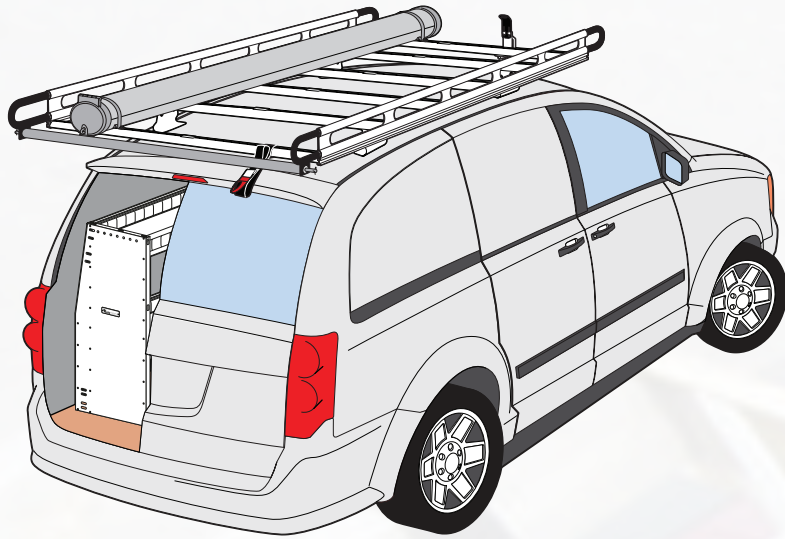



## H2 RACK SYSTEM

- › Bolts onto aluminum or steel body
- › Drilling required
- › All hardware and interior plates included
- › All aluminum design
- › Multiple cross bars at 16" apart
- › 2.25" x 1" cross bars
- › Built-in channels on the cargo rails and cross bars for additional accessories
- › Cargo rail lengths available in 84" or 96"
- › Rear adjustable roller allows for easy loading and unloading
- › Roller can extend beyond the edge of the roof
- › Colors available: black, white or silver

H2 Rack System	Description	Cross Bar	Color	Capacity
	H2 84" Cargo System	50"	B / W / S	600 lbs.
	H2 96" Cargo System	50"	B / W / S	600 lbs.
		60"	B / W / S	600 Lbs.

## H2 Accessories

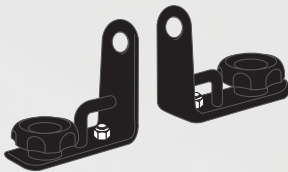

### Part #

A20

#### Adjustable Guide

- › Height: 5" tall
- › Fitment: Cross bars with channels
- › Material: Galvanized steel rubber dipped

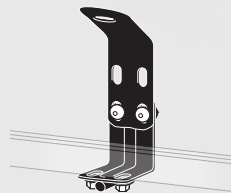

### Part #

A57

#### Ladder Stopper

- › Height: 5-7" tall
- › Material: Galvanized steel rubber dipped
- › Color: Black

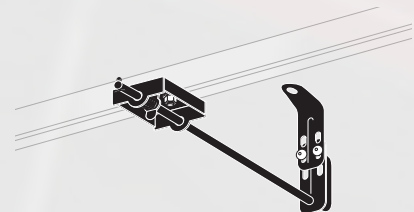

### Part #

A64

#### Push 2 Secure

- › Secure and lock ladder
- › Material: Galvanized steel rubber dipped
- › Color: Black

## H2 Accessories

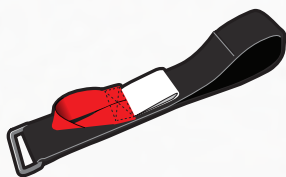

Part #
A69

### EZ Hook and loop fastener Strap

- › Strap loops onto cross bar
- › Capacity: 75 lbs.
- › Fitment: All Vantech cross bars
- › Material: Nylon
- › Color: Black & red

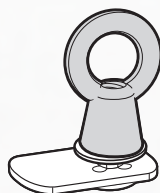

Part #	Size
A24	1"
A59	1.25"

### Eye hook

- › Fitment: Slides into aluminum channels
- › Material: Stainless steel
- › Color: Silver



Part #	Length
BG-550	50"
BG-560	60"

### Rubber Bar Guard

- › Non-slip rubber surface
- › Press-In installation method
- › Fitment: A285 cross bars
- › Material: Rubber
- › Color: Black

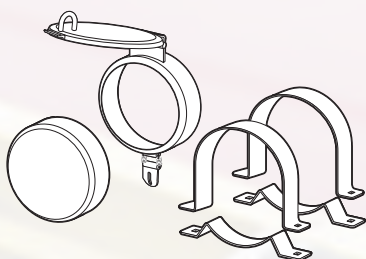

PART #
A34

### 6" Conduit Carrier Hatch & Cap

- › Fitment: A285 cross bars
- › Material: Aluminum
- › Color: Anodized black  
Anodized silver  
Powder coated white

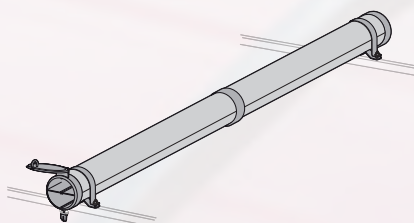

Part #	Description
CC-101	2 Compartment

### 6" x 128" long Conduit Carrier Kit

- › Material: Aluminum
- › Color: Anodized black  
Anodized silver  
Powder coated white
- › Tube only available in silver

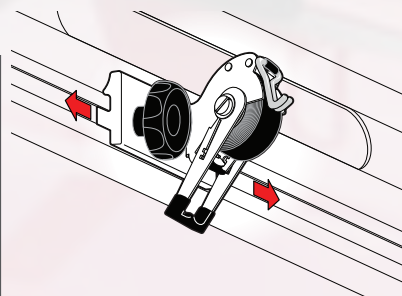

Part #
RTD10-H2

### Ratchet Tie-Down

- › Bolt-on system (no drilling required)
- › Self contained strap
- › Strap: 1.5" x 120"
- › Material: Stainless steel

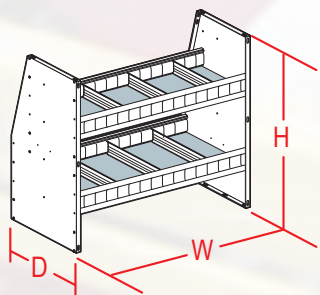

Height	Depth	36"	42"	48"
36"	11"	SA3636-2	SA3642-2	SA3648-2

### Aluminum Interior Shelving

- › Fitment: Mini vans / hatchback / pickup toppers with 36" clearance
- › Material: Aluminum
- › Levels: 2
- › Color: Silver

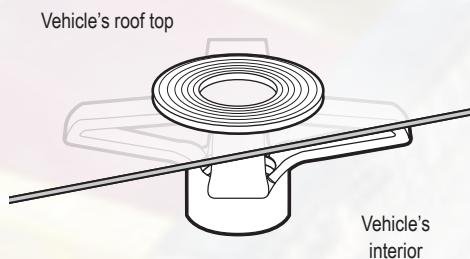

Part #
K059

### Anchor kit (Plus nut)

- › Install without removing upholstery
- › Qty: Pack of 8
- › Material: Zinc plated steel
- › More options on pg. 107

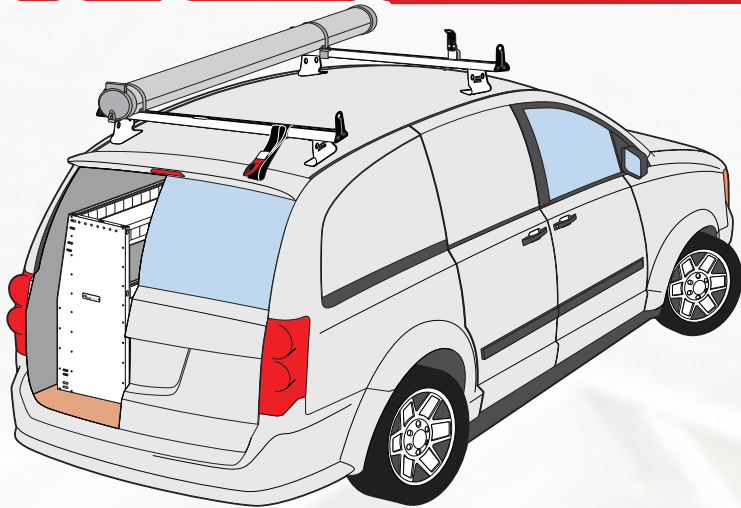

## J SERIES RACK SYSTEM

- › Bolts onto aluminum or steel body
- › Drilling required
- › All hardware and interior plates included
- › 2.25" x 1" or 3" x 1.5" cross bars available
- › All aluminum design
- › 4" wide mounting bases
- › Heavy duty 1/8" thick mounting bases
- › Built-in channels on the cross bars for additional accessories
- › 2 x .75" eyehooks per mounting base for easy tie down
- › Colors available: black, white or silver

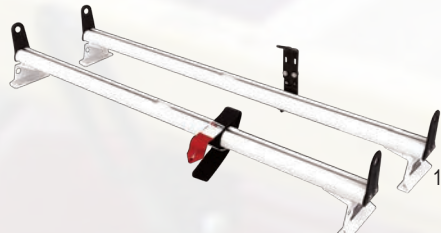
J series Rack System	Description	Width	Bar Type	Color	Capacity
	J1000 2 Bar System	50"	A285	B / W / S	500 lbs.
		60"	A285	B / W / S	500 lbs.
		55"	A286	B / W / S	600 lbs.
		65"	A286	B / W / S	600 lbs.
		72"	A286	B / W / S	600 lbs.
	J2000 2 Bar System  Included acc. 4 x Side Supports 1 x Ladder Stopper 1 x Hook and loop fastener Strap	50"	A285	B / W / S	500 lbs.
		60"	A285	B / W / S	500 lbs.
		55"	A286	B / W / S	600 lbs.
		65"	A286	B / W / S	600 lbs.
		72"	A286	B / W / S	600 lbs.

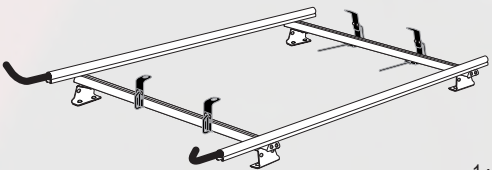
System	Description	Width	Bar Type	Color	Capacity	72" Side Rail
	J4000 2 Bar System  Included acc. 2 x Side Rails 1 x Ladder Stopper 1 x Push 2 Secure 1 x Hook and loop fastener Strap	50"	A285	B / W / S	500 lbs.	J4002
		60"	A285	B / W / S	500 lbs.	J4015

## J series Accessories

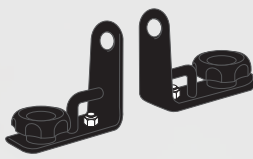
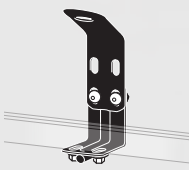
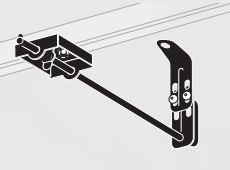
			
<b>Part #</b> A03 / A04	<b>Part #</b> A20	<b>Part #</b> A57	<b>Part #</b> A64
<b>Side Support</b> › Height : 4" tall from top of cross bar › Fitment: A03 fits A286 cross bars A04 fits A285 cross bars › Material: Galvanized steel rubber dipped	<b>Adjustable Guide</b> › Height: 5" tall › Fitment: Cross bars with channels › Material: Galvanized steel rubber dipped	<b>Ladder Stopper</b> › Height: 5-7" tall › Material: Galvanized steel rubber dipped › Color: Black	<b>Push 2 Secure</b> › Secure and lock ladder › Material: Galvanized steel rubber dipped › Color: Black

## J series Accessories

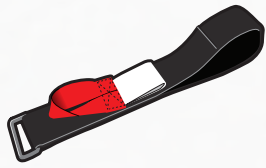

**Part #**

A69

**EZ Hook and loop fastener Strap**

- › Strap loops onto cross bar
- › Capacity: 75 lbs.
- › Fitment: All Vantech cross bars
- › Material: Nylon
- › Color: Black & red

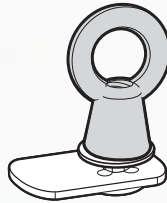

**Part #**

**Size**

A24

1"

A59

1.25"

**1" Eye hook**

- › Fitment: Slides into aluminum channels
- › Material: Stainless steel
- › Color: Silver

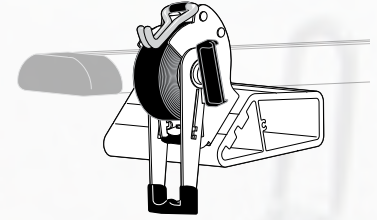

**Part #**

RTD10-H3

**Ratchet Tie-Down**

- › Bolt-on system (no drilling required)
- › Self contained strap
- › Strap: 1.5" x 120"
- › Material: Stainless steel

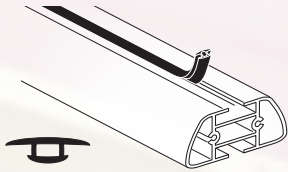

**Part # Length**

BG-550 50"

BG-560 60"

BG-555 55"

BG-565 65"

BG-572 72"

**Rubber Bar Guard**

- › Non-slip rubber surface
- › Press-In installation method
- › Fitment: A285/A286 cross bars
- › Material: Rubber
- › Color: Black

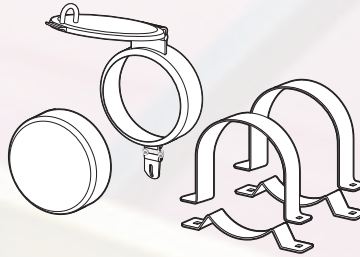

**PART #**

A34

**6" Conduit Hatch & Cap**

- › No drilling required
- › Secures to bars with sliders
- › Material: Aluminum
- › Color: Anodized black  
Anodized silver  
Powder coated white

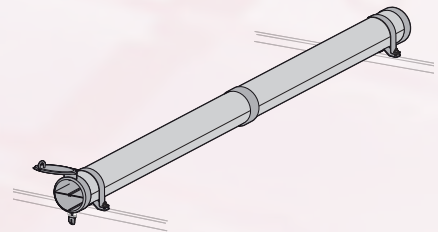

**Part # Description**

CC-101 2 Compartment

**6", 128" long Conduit Carrier Kit**

- › 3 or 4 compartments available (see page 110)
- › Material: Aluminum
- › Color: Anodized black  
Anodized silver  
Powder coated white
- › Tube only available in silver

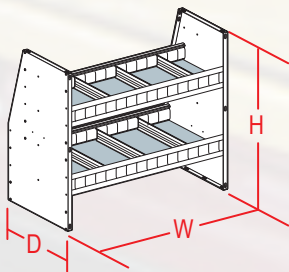

**Aluminum Interior Shelving**

- › Fitment: Mini vans / hatchback / pickup toppers with 36" clearance
- › Material: Aluminum
- › Levels: 2
- › Color: Silver

Height	Depth	36"	42"	48"
36"	11"	SA3636-2	SA3642-2	SA3648-2

Vehicle's roof top

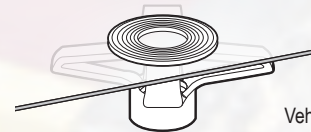

Vehicle's Interior

**Part #**

K059

**Anchor kit (Plus nut)**

- › Install without removing upholstery
- › Qty: Pack of 8
- › Material: Zinc plated steel
- › More options on pg. 107

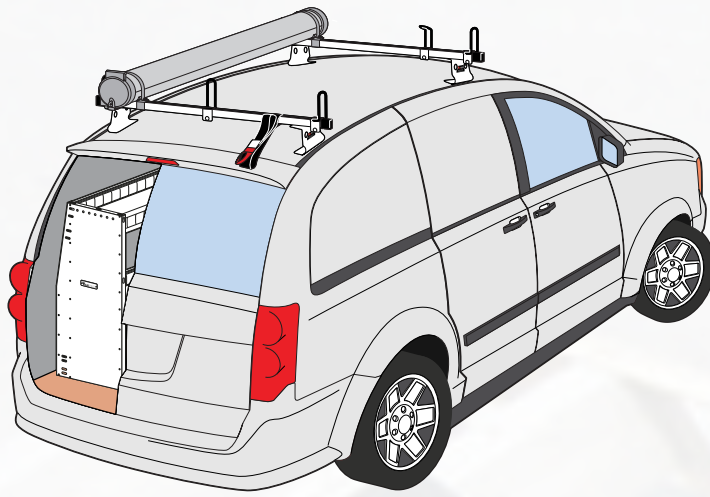

## M SERIES RACK SYSTEM

- › Bolts onto aluminum or fiberglass body
- › Drilling required
- › Cross bars from 50" - 84" length
- › 10.75" total height
- › 6" extra wide mounting bases
- › Polyfoam gaskets for tight seal
- › 2 x .75" eyehooks per mounting base for easy tie down
- › Colors available: black or white

### STEEL SYSTEM

- › Heavy duty grade
- › Economical

### ALUMINUM SYSTEM

- › Rust free
- › Stainless steel hardware
- › Lightweight

(more info see page 9)

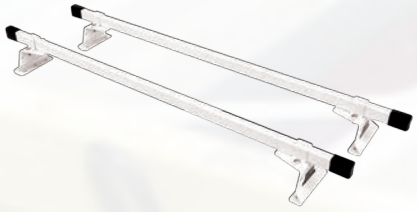
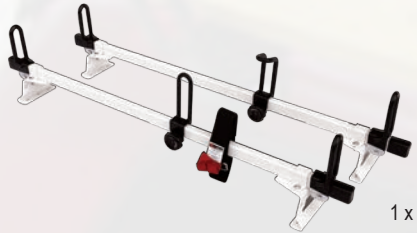
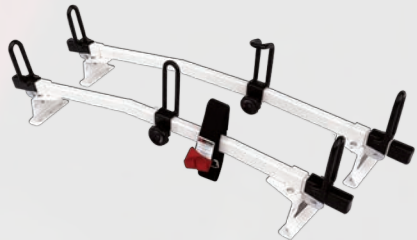
M series Rack System	Description	Width	Color	ST	AL
	M1000 2 Bar System	50"	B / W	M1005	M1105
		60"	B / W	M1000	M1100
		72"	B / W	M1050	M1150
		84"	B / W	M1075	n/a
	M2000 2 Bar System  Included acc. 4 x Side Supports 4 x Endcaps 1 x Ladder Stopper 1 x Ladder Guide 1 x Hook and loop fastener Strap	50"	B / W	M2005	M2105
		60"	B / W	M2000	M2100
		72"	B / W	M2050	M2150
		84"	B / W	M2075	n/a
	M3000 2 Angled Bar System  Included acc. 4 x Side Supports 4 x Endcaps 1 x Ladder Stopper 1 x Ladder Guide 1 x Hook and loop fastener Strap	59"	B / W	M3000	M3100

## M-Series Accessories



### Part #

A01

#### Ladder Guide

- › Height: 5.5" tall
- › Fitment: M series (1" x 2")
- › Material: Galvanized Steel
- › Finish: Black Rubber



### Part #

A05

#### Ladder Stopper

- › Height: 5" tall
- › Fitment: M series (1" x 2")
- › Material: Galvanized Steel
- › Finish: Black Rubber



### Part #

A09

#### Side Support

- › Height: 5.5" tall
- › Fitment: M series (1" x 1.5")
- › Material: Galvanized steel
- › Finish: Black rubber

## M series Accessories

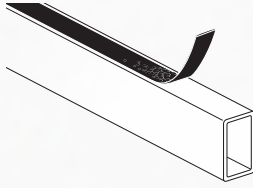

Part #	Length
BG-050	50"
BG-060	60"
BG-072	72"
BG-084	84"

### Plastic Bar Guard

- › Textured plastic surface
- › Adhesive backing
- › Material: Plastic
- › Color: Black

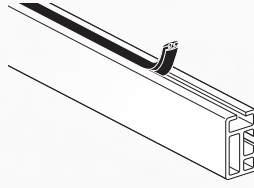

Part #	Length
BG-542	42"
BG-552	52"
BG-564	64"
BG-576	76"

### Rubber Bar Guard

- › Non-slip rubber surface
- › Press-In installation method
- › Material: Rubber
- › Color: Black

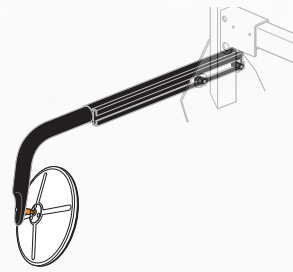

Part #	Adjustment
A82	25"-32"

### Back-Up 8" Convex Mirror

- › Installs onto eye hooks
- › Material: Aluminum
- › Color: Anodized black

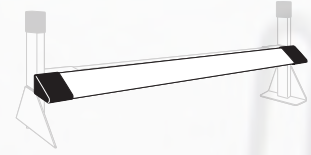

Part #	Length
WF-50	50"
WF-60	60"

### Wind Foil

- › Decreases wind noise and vibrations
- › Material: Aluminum
- › Color: Anodized black  
Anodized silver  
Powder coated white

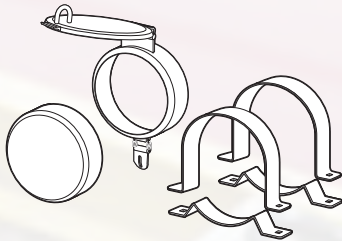

### PART #

A37

- › **6" Conduit Hatch & Cap**
- › No drilling required.
- › Includes: Cross bar clamps
- › Material: Aluminum
- › Color: Anodized black  
Anodized silver  
Powder coated white

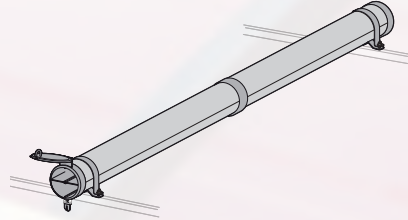

### Part # Description

CC-103 2 Compartment

- › **6" x 128" Conduit Carrier Kit**
- › 3 or 4 compartments available (see page 110)
- › Material: Aluminum
- › Color: Anodized black  
Anodized silver  
Powder coated white
- › Tube only available in silver

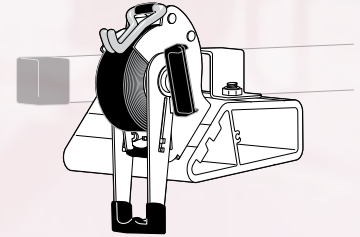

### Part #

RTD10-M

- › **Ratchet Tie-Down**
- › Bolt-on system (no drilling required)
- › Self contained strap
- › Strap: 1.5" x 120"
- › Material: Stainless steel/Aluminum

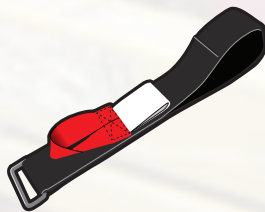

### Part #

A69

### EZ Hook and loop fastener Strap

- › Strap loops onto cross bar
- › Capacity: 75 lbs.
- › Fitment: All Vantech cross bars
- › Material: Nylon
- › Color: Black & red

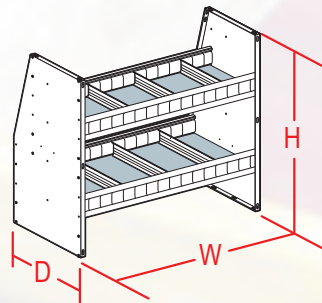

Height	Depth	36"	42"	48"
36"	11"	SA3636-2	SA3642-2	SA3648-2

### Aluminum Interior Shelving

- › Fitment: Mini vans/ hatchback with 36" clearance
- › Material: Aluminum
- › Levels: 2
- › Color: Silver

Vehicle's roof top

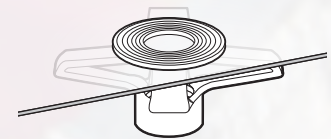

Vehicle's interior

### Part #

K059

### Anchor kit (Plus nut)

- › Install without removing upholstery
- › Qty: Pack of 8
- › Material: Zinc plated steel
- › More options on pg 107

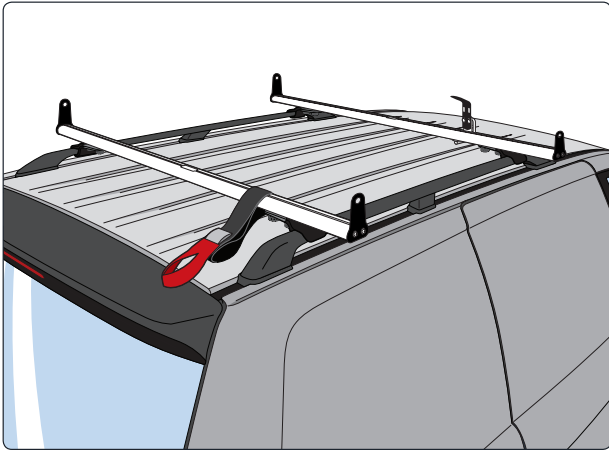

## OE SERIES RACK SYSTEM

- › Clamps onto factory side rails
- › Fits factory rails from .5" - 1.5"
- › Easy off twist knob
- › 2.25" x 1" cross bars
- › All aluminum design
- › 1/8" thick mounting clamps dipped in rubber
- › Built-in channels on the cross bars for additional accessories
- › \*Load capacity (Read factory manual for weight load specifications)
- › Colors available: black, white or silver

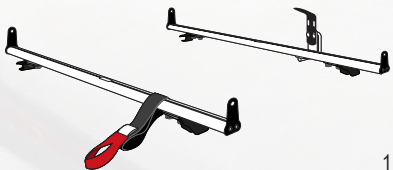
OE Rack System	Description	Cross Bar	Material	Color
	OE1000 2 Bar Clamp-On System	50"	Aluminum	B / W / S
		60"	Aluminum	B / W / S
	OE2000 2 Bar Clamp-On System	50"	Aluminum	B / W / S
	Included acc. 4 x Side Supports 1 x Ladder Stopper 1 x EZ Hook and loop fastener Strap	60"	Aluminum	B / W / S

## OE series Accessories

			
<b>Part #</b> A04	<b>Part #</b> A20	<b>Part #</b> A57	<b>Part #</b> A64
<b>Side Support</b>	<b>Adjustable Guide</b>	<b>Ladder Stopper</b>	<b>Push 2 Secure</b>
› Height : 4" tall from top of cross bar	› Height: 5" tall	› Height: 5-7" tall	› Secure and lock ladder
› Fitment: A285 cross bars	› Fitment: Cross bars with channels	› Material: Galvanized steel rubber dipped	› Material: Galvanized steel rubber dipped
› Material: Galvanized steel rubber dipped	› Material: Galvanized steel rubber dipped	› Color: Black	› Color: Black

## OE series Accessories

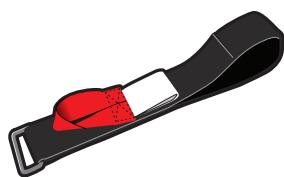

**Part #**

A69

**EZ Hook and loop fastener Strap**

- › Strap loops onto cross bar
- › Capacity: 75 lbs.
- › Fitment: All Vantech cross bars
- › Material: Nylon
- › Color: Black & red



**Part #      Size**

A24	1"
A59	1.25"

**Eye hook**

- › Fitment: Slides into aluminum channels
- › Material: Stainless steel
- › Color: Silver

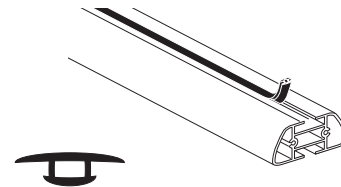

**Part #      Length**

BG-550	50"
BG-560	60"

**Rubber Bar Guard**

- › Non-slip rubber surface
- › Press-In installation method
- › Fitment: A285 cross bars
- › Material: Rubber
- › Color: Black

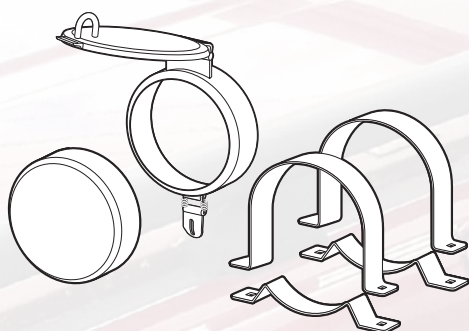

**PART #**

A34

**6" Conduit Hatch & Cap**

- › No drilling required
- › Secures to bars with sliders
- › Material: Aluminum
- › Color: Anodized black  
Anodized silver  
Powder coated white

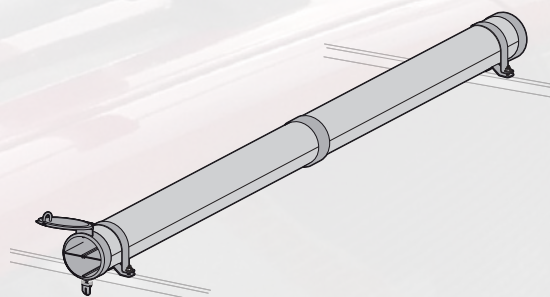

**Part #**

CC-101

**Description**

2 Compartment

**6" x 128" Conduit Carrier Kit**

- › 3 or 4 compartments available (see page 110)
- › Material: Aluminum
- › Color: Anodized black  
Anodized silver  
Powder coated white
- › Tube only available in silver

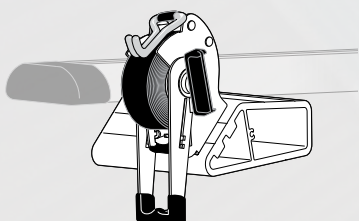

**Part #**

RTD10-H3

**Ratchet Tie-Down**

- › Bolt-on system (no drilling required)
- › Self contained strap
- › Strap: 1.5" x 120"
- › Material: Stainless steel

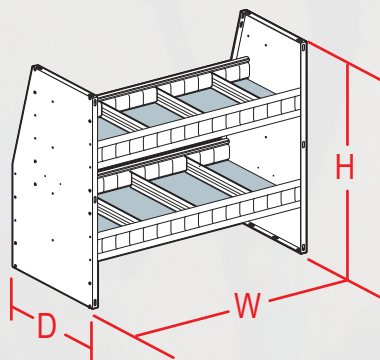

**Aluminum Interior Shelving**

- › Fitment: Mini Vans/ Hatchback with 36" clearance
- › Material: Aluminum
- › Levels: 2
- › Color: Silver

Height	Depth	Levels	36"	42"	48"
36"	11"	2	SA3636-2	SA3642-2	SA3648-2



## P3000 RamBox Edition

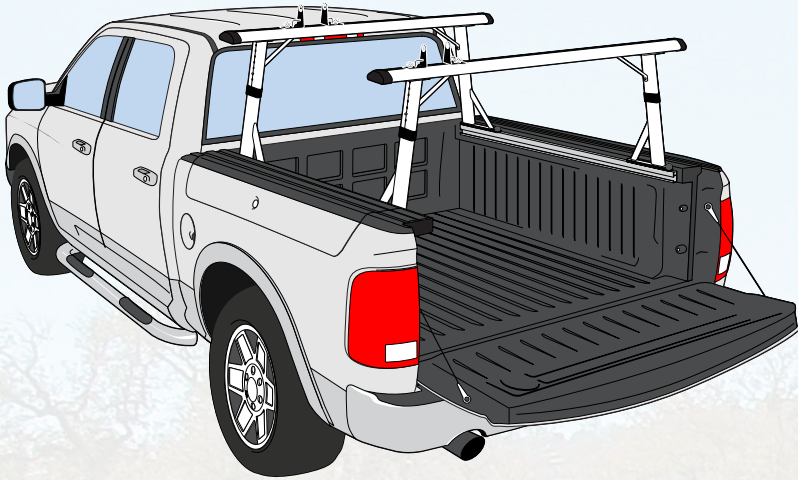

- › Slides into factory RamBox tracks
- › Twist knob to secure
- › Adjustable uprights from 21.25" - 28.25"
- › 55" wide loading area
- › Heavy duty 3" x 1.5" cross bars
- › Built-in channels on the cross bars for additional accessories
- › All aluminum design
- › Anodized finish
- › Colors available: black or silver

### P3000 Rack System

Description Cross Bar Material Color Capacity



P3000 System with  
RamBox Adaptor

Included acc.  
2 x Adjustable Guide  
4 x RamBox Adaptor

55" Aluminum B/S 450 lbs.

### P3000 Accessories



Part #

A03

#### Side Support

- › Height: 4" tall from top of cross bar.
- › Material: Galvanized steel
- › Finish: Rubber coated



Part #

A20

#### Adjustable Guide

- › Height: 5" tall
- › Material: Galvanized steel
- › Finish: Rubber coated



Part #

A57

#### Ladder Stopper

- › Height: 5-7" tall
- › Material: Galvanized steel rubber dipped
- › Color: Black

## P3000 Accessories

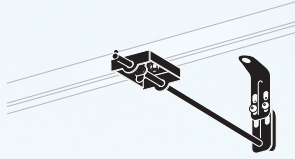

**Part #**

A64

**Push 2 Secure**

- ▶ Secure and lock ladder
- ▶ Material: Galvanized steel
- ▶ Color: Black

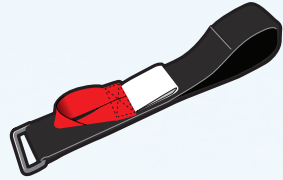

**Part #**

A69

**EZ Hook and loop fastener Strap**

- ▶ Strap loops onto cross bar
- ▶ Capacity: 75 lbs.
- ▶ Fitment: All Vantech cross bars
- ▶ Material: Nylon
- ▶ Color: Black & red

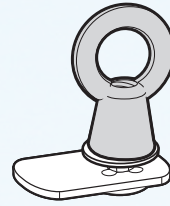

**Part #**

A24

**Size**

1"

**A59**

1.25"

**Eye hook**

- ▶ Fitment: Slides into aluminum channels
- ▶ Material: Stainless steel
- ▶ Color: Silver

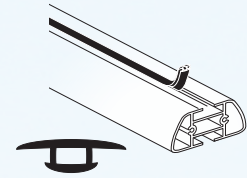

**Part #**

BG-555

**Length**

55"

**Rubber Bar Guard**

- ▶ Non-slip rubber surface
- ▶ Press-In installation method
- ▶ Fitment: A286 cross bars
- ▶ Material: Rubber
- ▶ Color: Black

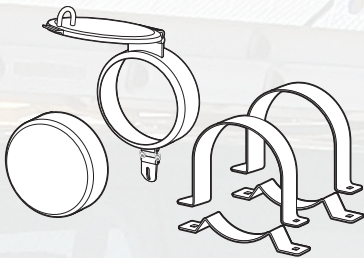

**PART #**

A34

**6" Conduit Hatch & Cap**

- ▶ No drilling required
- ▶ Secures to bars with sliders
- ▶ Material: Aluminum
- ▶ Color: Anodized black  
Anodized silver  
Powder coated white

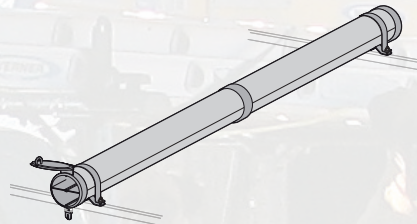

**Part #**

CC-101

**Description**

2 Compartment

**6" x 128" Conduit Carrier Kit**

- ▶ 3 or 4 compartments available (see page 110)
- ▶ Material: Aluminum
- ▶ Color: Anodized black  
Anodized silver  
Powder coated white
- ▶ Tube only available in silver

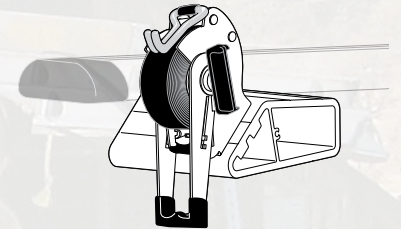

**Part #**

RTD10-H3

**Ratchet Tie-Down**

- ▶ Bolt-on system (no drilling required)
- ▶ Self contained strap
- ▶ Strap: 1.5" x 120"
- ▶ Material: Stainless steel/Aluminum

## P3000 Cantilever Upgrade System

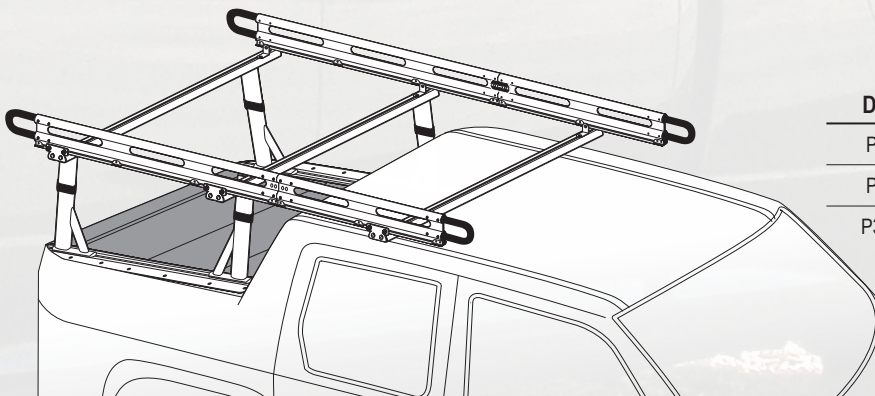

**P3000 with cargo rail conversion kit**

- ▶ 3rd bar maximum weight 100 lbs (84"), 75 lbs (96"), 50 lbs (120")

Description	Cross Bar	Cargo Rail
P3000-55-84	55"	84"
P3000-55-96	55"	96"
P3000-55-120	55"	120"

## P3000 AVALANCHE EDITION

- › Replacement grab handles with built-in mounts
- › Combine system with factory or aftermarket roof rack to transport extended load
- › Adjustable uprights from 21.25" - 28.25" (no drilling required)
- › Does not interfere with factory tonneau cover
- › All aluminum design
- › Max load capacity 150lbs (evenly distributed)
- › 55" wide loading area
- › Heavy duty 3" x 1.5" cross bars
- › Built-in channels on the cross bars for additional accessories
- › Anodized finish
- › Colors available: black or silver

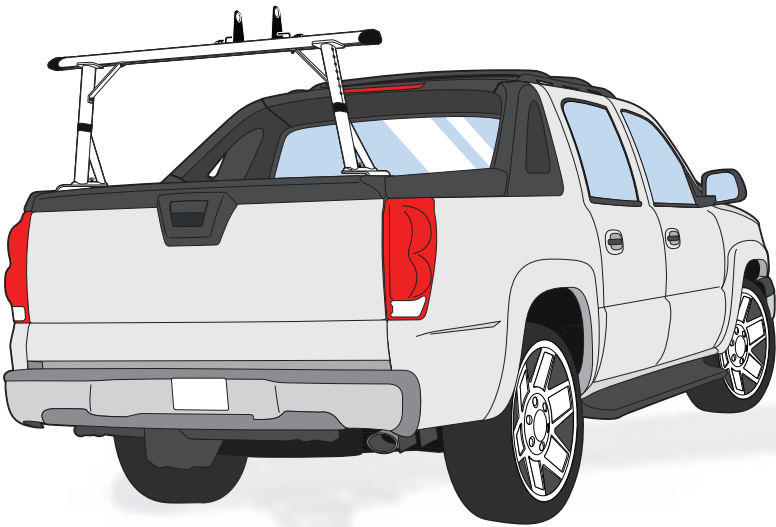

### P3000 Rack System

### Description

### Cross Bar

### Bar Type

### Material

### Color

### Capacity



P3000 System with  
Grab Handle Adaptor  
Single Bar

55"

A286

Aluminum

B / S

150 lbs.

Included acc.  
1 x Adjustable Guide

### OE Rack System

### Description

### Cross Bar

### Bar Type

### Material

### Color

### Capacity

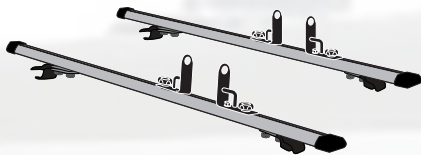

OE 1000 2 Bar  
Clamp-On System  
(Factory Rail)

55"

A286

Aluminum

B / S

150 lbs.

Included acc.  
2 x Adjustable Guide

## P3000 Accessories



### Part #

A03

### Side Support

- › Height: 4" tall from top of cross bar.
- › Material: Galvanized steel
- › Finish: Rubber coated



### Part #

A20

### Adjustable Guide

- › Height: 5" tall
- › Material: Galvanized steel
- › Finish: Rubber coated

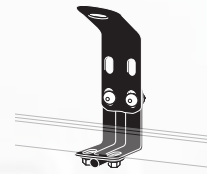

### Part #

A57

### Ladder Stopper

- › Height: 5-7" tall
- › Material: Galvanized steel rubber dipped
- › Color: Black

## P3000 Accessories

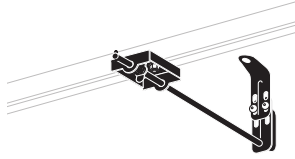

**Part #**

A64

**Push 2 Secure**

- › Secure and lock ladder
- › Material: Galvanized steel
- › Color: Black

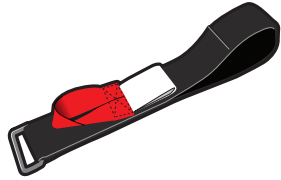

**Part #      MRP**

A69

**EZ Hook and loop fastener Strap**

- › Strap loops onto cross bar
- › Capacity: 75 lbs.
- › Fitment: All Vantech cross bars
- › Material: Nylon
- › Color: Black & red



**Part #      Size**

A24      1"

A59      1.25"

**Eye hook**

- › Fitment: Slides into aluminum channels
- › Material: Stainless steel
- › Color: Silver

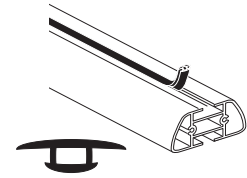

**Part #      Length**

BG-555      55"

**Rubber Bar Guard**

- › Non-slip rubber surface
- › Press-In installation method
- › Fitment: A286 cross bars
- › Material: Rubber
- › Color: Black

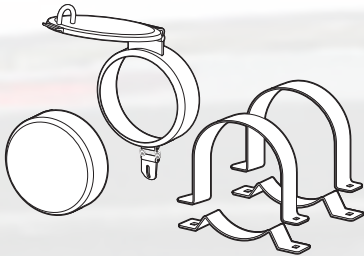

**PART #**

A34

**6" Conduit Hatch & Cap**

- › No drilling required
- › Secures to bars with sliders
- › Material: Aluminum
- › Color: Anodized black  
Anodized silver  
Powder coated white

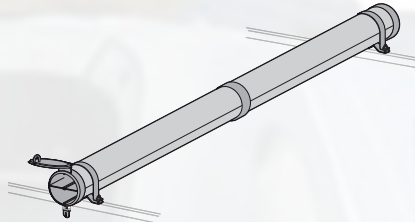

**Part #      Description**

CC-101      2 Compartment

**6" x 128" Conduit Carrier Kit**

- › 3 or 4 compartments available (see page 110)
- › Material: Aluminum
- › Color: Anodized black  
Anodized silver  
Powder coated white
- › Tube only available in silver
- › Use in combination with OE1302

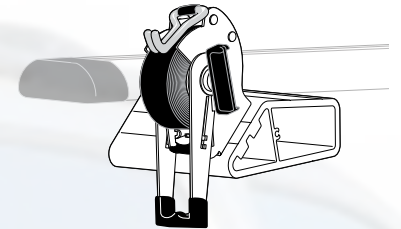

**Part #**

RTD10-H3

**› Ratchet Tie-Down**

- › Bolt-on system (no drilling required)
- › Self contained strap
- › Strap: 1.5" x 120"
- › Material: Stainless steel/Aluminum

## P3000 Cantilever Upgrade System

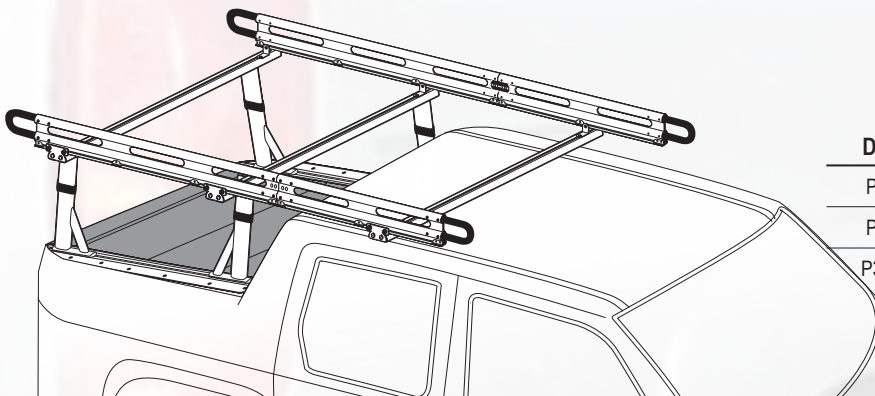

Description	Cross Bar	Cargo Rail
P3000-55-84	55"	84"
P3000-55-96	55"	96"
P3000-55-120	55"	120"

**P3000 with cargo rail conversion kit**

- › 4rd bar maximum weight 100 lbs (84"), 75 lbs (96"), 50 lbs (120")
- › Use in combination with OE1302

## P3000 RIDGELINE EDITION

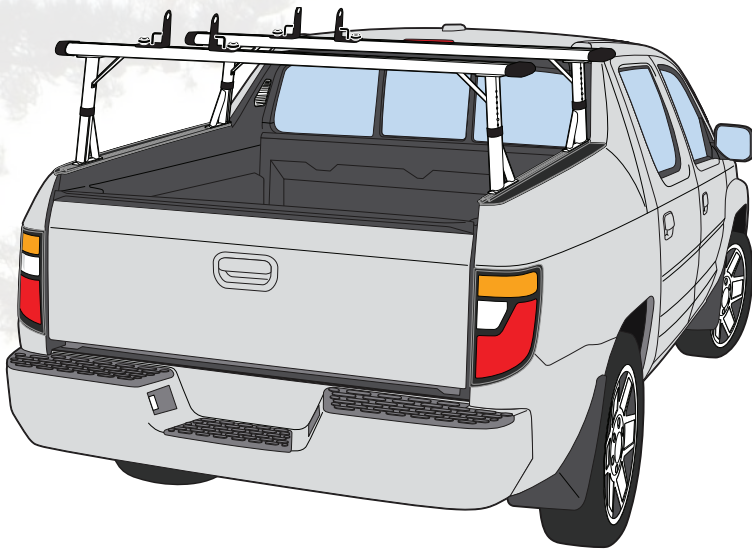

- › Integrated bedrail adaptor to securely mount system onto factory slots or over plastic cover (drilling may be required)
- › Combine system with factory or aftermarket roof rack to transport extended load (see page 86)
- › Adjustable uprights (no drilling required)
- › Angled uprights to adapt to the tilted bedrails
- › Heavy duty 3" x 1.5" cross bars
- › Built-in channels on the cross bars for additional accessories
- › All aluminum design
- › Anodized finish
- › Colors available: black or silver
- › Max load capacity 600lbs (evenly distributed)

### P3000 Rack System

### Description

### Fitment

### Cross Bar

### Material

### Color

### Capacity



P3000 System with  
Bedrail Adaptor

Included acc.  
2 x Adjustable Guide  
(pair)

2005-16

65"

Aluminum

B / S

600 lbs.



**NEW Product  
2017**

P3000 System with  
Bedrail Adaptor

Included acc.  
2 x Adjustable Guide  
(pair)

2017-On

65"

Aluminum

B / S

600 lbs.

## P3000 Accessories



**Part #**

A03

### Side Support

- › Height: 4" tall from top of cross bar.
- › Material: Galvanized steel
- › Finish: Rubber coated



**Part #**

A20

### Adjustable Guide

- › Height: 5" tall
- › Material: Galvanized steel
- › Finish: Rubber coated

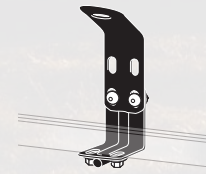

**Part #**

A57

### Ladder Stopper

- › Height: 5-7" tall
- › Material: Galvanized steel rubber dipped
- › Color: Black

## P3000 Accessories

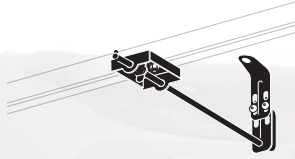

**Part #**

A64

**Push 2 Secure**

- › Secure and lock ladder
- › Material: Galvanized steel
- › Color: Black



**Part #      MRP**

A69

**EZ Hook and loop fastener Strap**

- › Strap loops onto cross bar
- › Capacity: 75 lbs.
- › Fitment: All Vantech cross bars
- › Material: Nylon
- › Color: Black & red



**Part #      Size**

A24      1"  
A59      1.25"

**Eye hook**

- › Fitment: Slides into aluminum channels
- › Material: Stainless steel
- › Color: Silver

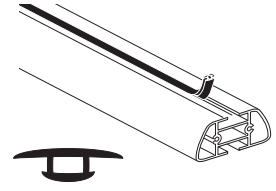

**Part #      Length**

BG-565      65"  
BG-572      72"

**Rubber Bar Guard**

- › Non-slip rubber surface
- › Press-In installation method
- › Fitment: A286 cross bars
- › Material: Rubber
- › Color: Black

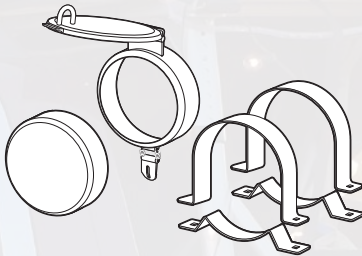

**PART #**

A34

**6" Conduit Hatch & Cap**

- › No drilling required
- › Secures to bars with sliders
- › Material: Aluminum
- › Color: Anodized black  
Anodized silver  
Powder coated white

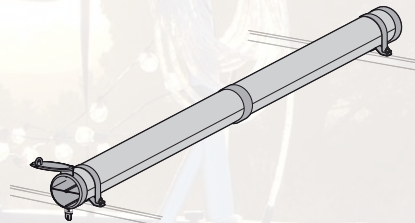

**Part #      Description**

CC-101      2 Compartment

**6" x 128" Conduit Carrier Kit**

- › 3 or 4 compartments available (see page 110)
- › Material: Aluminum
- › Color: Anodized black  
Anodized silver  
Powder coated white
- › Tube only available in silver

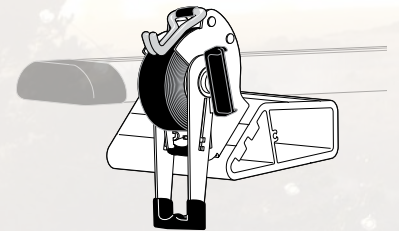

**Part #**

RTD10-H3

**› Ratchet Tie-Down**

- › Bolt-on system (no drilling required)
- › Self contained strap
- › Strap: 1.5" x 120"
- › Material: Stainless steel

## P3000 Cantilever Upgrade System

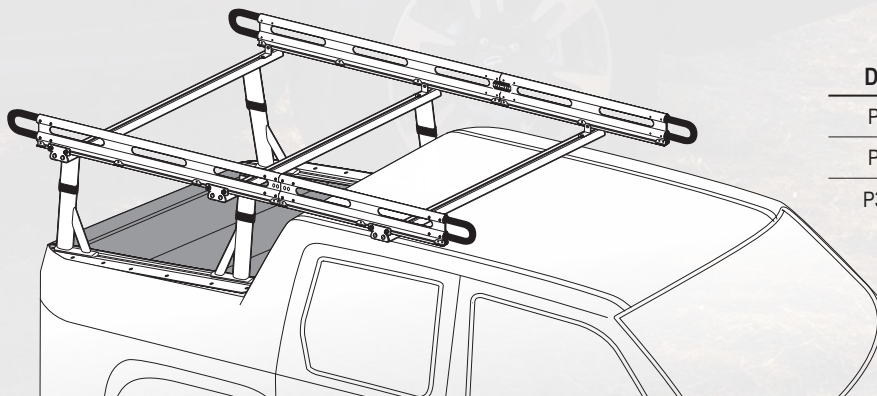

**P3000 with cargo rail conversion kit**

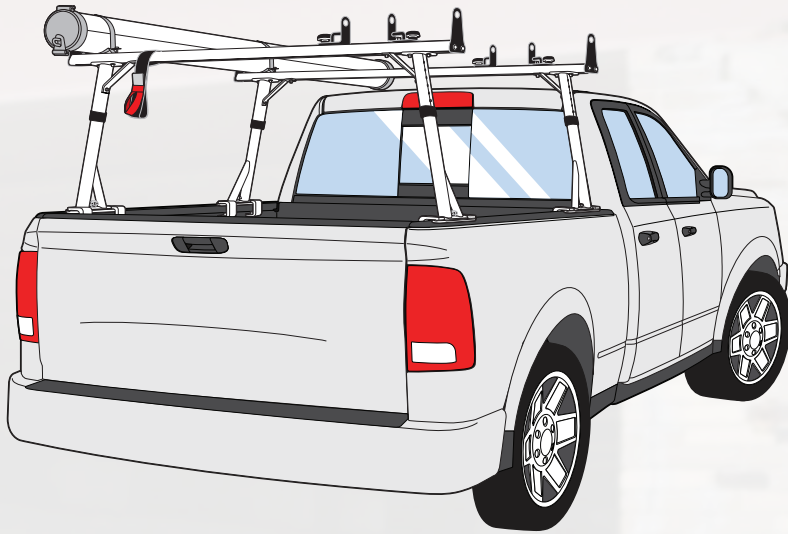

- › 3rd bar maximum weight 100 lbs (84"), 75 lbs (96"), 50 lbs (120")

Description	Cross Bar	Cargo Rail
P3000-65-84	65"	84"
P3000-65-96	65"	96"
P3000-65-120	65"	120"



## P3000 Rack System

- › 2 installation methods available:
  - (a) Clamp-on to factory bedrails (no drilling required)
  - (b) Bolt-on (drilling required to mount to adaptor plate)
- › All aluminum design
- › Max load capacity 800lbs (evenly distributed)
- › Adjustable uprights from 21.25" - 28.25"
- › Heavy duty 3" x 1.5" cross bars
- › Cross bar length available from 65", 72" or 84"
- › Built-in channels on the cross bars for additional accessories
- › Anodized finish
- › Color available: black or silver

P3000 Rack System	Description	Cross Bar	Material	Color	Capacity
<b>Bolt-On</b> 	P3000 Bolt-On System (Drilling Required)  Included acc. 2 x Adjustable Guide	65"	Aluminum	B / S	800 lbs.
		72"	Aluminum	B / S	800 lbs.
		84"	Aluminum	B / S	800 lbs.
<b>Clamp-On</b> 	P3000 Clamp-On System (No Drilling Required)  Included acc. 2 x Adjustable Guide	65"	Aluminum	B / S	800 lbs.
		72"	Aluminum	B / S	800 lbs.
		84"	Aluminum	B / S	800 lbs.

## P3000 Accessories



Part #

A03

### Side Support

- › Height: 4" tall from top of cross bar.
- › Material: Galvanized steel
- › Finish: Rubber coated



Part #

A20

### Adjustable Guide

- › Height: 5" tall
- › Material: Galvanized steel
- › Finish: Rubber coated

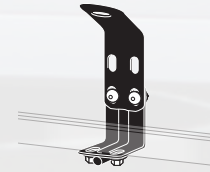

Part #

A57

### Ladder Stopper

- › Height: 5-7" tall
- › Material: Galvanized steel rubber dipped
- › Color: Black

## P3000 Accessories

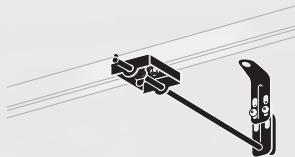

**Part #**

A64

**Push 2 Secure**

- › Secure and lock ladder
- › Material: Galvanized steel
- › Color: Black

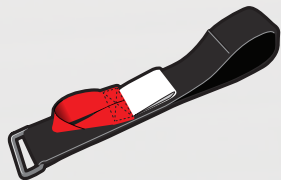

**Part #**

A69

**EZ Hook and loop fastener Strap**

- › Strap loops onto cross bar
- › Capacity: 75 lbs.
- › Fitment: All Vantech cross bars
- › Material: Nylon
- › Color: Black & red



**Part #**

A24

**Size**

1"

A59

1.25"

**Eye hook**

- › Fitment: Slides into aluminum channels
- › Material: Stainless steel
- › Color: Silver

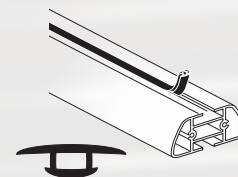

**Part # Length**

BG-565 65"

BG-572 72"

BG-584 84"

**Rubber Bar Guard**

- › Non-slip rubber surface
- › Press-In installation method
- › Fitment: A286 cross bars
- › Material: Rubber
- › Color: Black

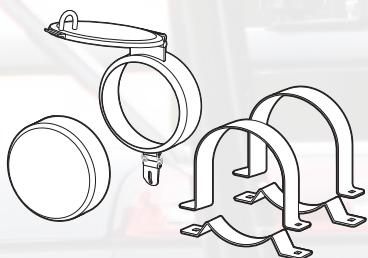

**PART #**

A34

**6" Conduit Hatch & Cap**

- › No drilling required
- › Secures to bars with sliders
- › Material: Aluminum
- › Color: Anodized black  
Anodized silver  
Powder coated white

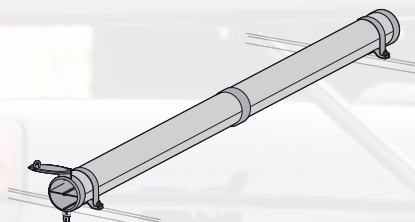

**Part # Description**

CC-101 2 Compartment

**6" x 128" Conduit Carrier Kit**

- › 3 or 4 compartments available (see page 110)
- › Material: Aluminum
- › Color: Anodized black  
Anodized silver  
Powder coated white
- › Tube only available in silver

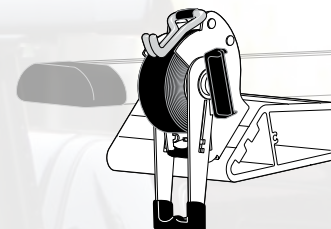

**Part #**

RTD10-H3

- › **Ratchet Tie-Down**
- › Bolt-on system (no drilling required)
- › Self contained strap
- › Strap: 1.5" x 120"
- › Material: Stainless steel

## P3000 Cantilever Upgrade System

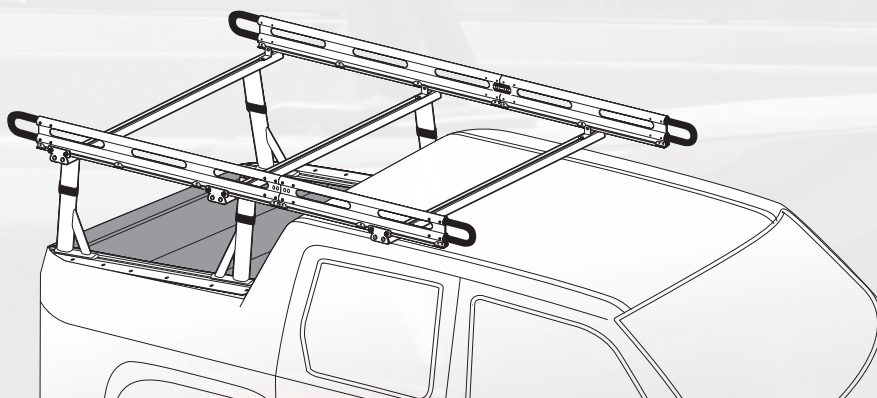

**P3000 with cargo rail conversion kit**

- › 3rd bar maximum weight 100 lbs (84"), 75 lbs (96"), 50 lbs (120")

Description	Cross Bar	Cargo Rail
P3000-65-84	65"	84"
P3000-65-96	65"	96"
P3000-65-120	65"	120"
P3000-72-84	72"	84"
P3000-72-96	72"	96"
P3000-72-120	72"	120"
P3000-84-84	84"	84"
P3000-84-96	84"	96"
P3000-84-120	84"	120"



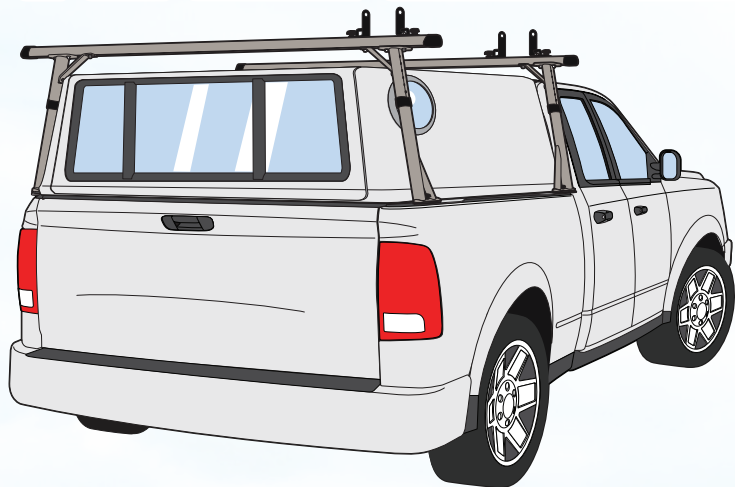

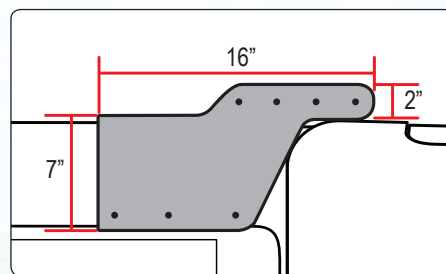
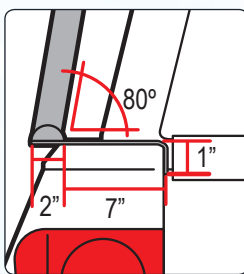
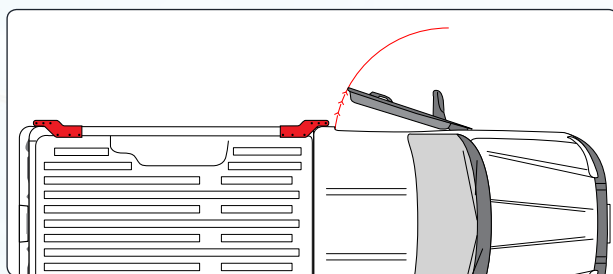

## P3000 Rack System

- › 2 height clearance available:
  - (a) 21.25" - 28.25"
  - (b) 31.75" - 34.75"
- › All aluminum lightweight design
- › Bolts onto bedrail with 9" extension plates (drilling required)
- › Maximum load capacity 600lbs (evenly distributed)
- › Heavy duty 3" x 1.5"
- › Cross bar length available from 72" - 84"
- › Built-in channels on the cross bars for additional accessories
- › Extension plates can integrate with aftermarket truck box
- › Anodized finish
- › Color available: black or silver



P3000 Rack System	Description	Topper / Cap Clearance	Cross Bar	Material	Color	Capacity
	P3000 (Standard) with Extension Plate  Included acc. 2 x Adjustable guide 4 x Ext Plate	21.25" - 28.25"	72"	Aluminum	B / S	450 lbs.
			84"	Aluminum	B / S	450 lbs.
	P3000 (Tall) with Extension Plate  Included acc. 2 x Adjustable guide 4 x Ext Plate	31.75" - 34.75"	72"	Aluminum	B / S	450 lbs.
			84"	Aluminum	B / S	450 lbs.

## P3000 Accessories



Part #

A03

### Side Support

- › Height: 4" tall from top of cross bar.
- › Material: Galvanized steel
- › Finish: Rubber coated



Part #

A20

### Adjustable Guide

- › Height: 5" tall
- › Material: Galvanized steel
- › Finish: Rubber coated

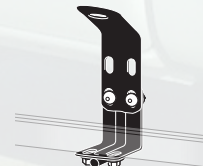

Part #

A57

### Ladder Stopper

- › Height: 5-7" tall
- › Material: Galvanized steel rubber dipped
- › Color: Black

## P3000 Accessories

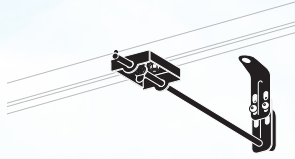

**Part #**

A64

**Push 2 Secure**

- › Secure and lock ladder
- › Material: Galvanized steel
- › Color: Black

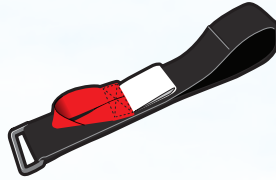

**Part #**

A69

**EZ Hook and loop fastener Strap**

- › Strap loops onto cross bar
- › Capacity: 75 lbs.
- › Fitment: All Vantech cross bars
- › Material: Nylon
- › Color: Black & red

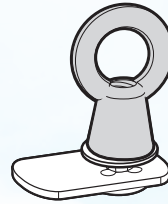

**Part #**

**Size**

A24	1"
A59	1.25"

**Eye hook**

- › Fitment: Slides into aluminum channels
- › Material: Stainless steel
- › Color: Silver

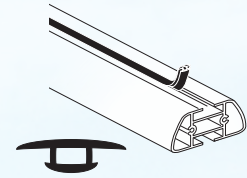

**Part # Length**

BG-565	65"
BG-572	72"
BG-584	84"

**Rubber Bar Guard**

- › Non-slip rubber surface
- › Press-In installation method
- › Fitment: A286 cross bars
- › Material: Rubber
- › Color: Black

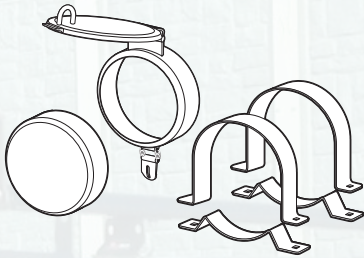

**PART #**

A34

**6" Conduit Hatch & Cap**

- › No drilling required
- › Secures to bars with sliders
- › Material: Aluminum
- › Color: Anodized black  
Anodized silver  
Powder coated white

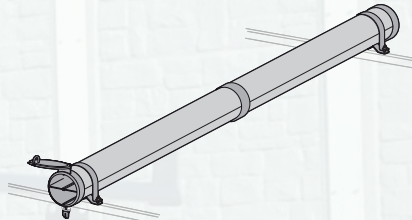

**Part # Description**

CC-101 2 Compartment

**6" x 128" Conduit Carrier Kit**

- › Material: Aluminum
- › Color: Anodized black  
Anodized silver  
Powder coated white
- › Tube only available in silver

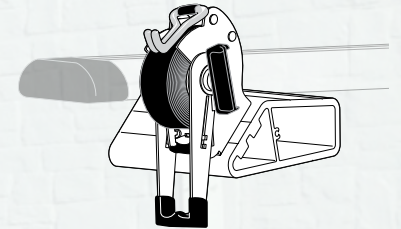

**Part #**

RTD10-H3

**› Ratchet Tie-Down**

- › Bolt-on system (no drilling required)
- › Self contained strap
- › Strap: 1.5" x 120"
- › Material: Stainless steel

## P3000 Cantilever Upgrade System

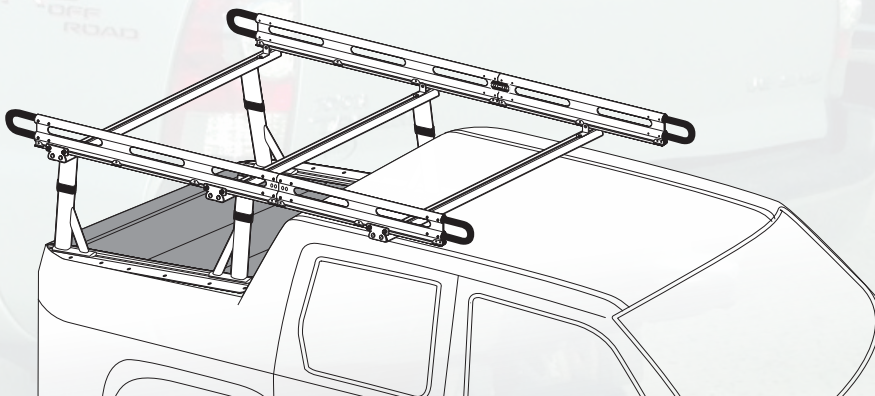

**P3000 with cargo rail conversion kit**

- › 3rd bar maximum weight 100 lbs (84"), 75 lbs (96"), 50 lbs (120")

Description	Cross Bar	Cargo Rail
P3000-72-84	72"	84"
P3000-72-96	72"	96"
P3000-72-120	72"	120"
P3000-84-84	84"	84"
P3000-84-96	84"	96"
P3000-84-120	84"	120"

## H1 RACK SYSTEM

- › Universal system
- › Bolts onto aluminum, steel or fiberglass body
- › Drilling required
- › All hardware and interior plates included
- › Cross bar length available from 42" - 63"
- › Low profile 10.5" total clearance
- › 4 x .75" eyehooks per mounting base for easy tie down
- › Materials available: steel, aluminum or stainless steel
- › Colors available: black, white or silver

### STEEL SYSTEM

- › Heavy duty grade
- › Economical

### STAINLESS STEEL SYSTEM

- › Rust free
- › Stainless steel hardware
- › Longer lasting durability

### ALUMINUM SYSTEM

- › Rust free
- › Stainless steel hardware
- › Lightweight

(more info see page 3)

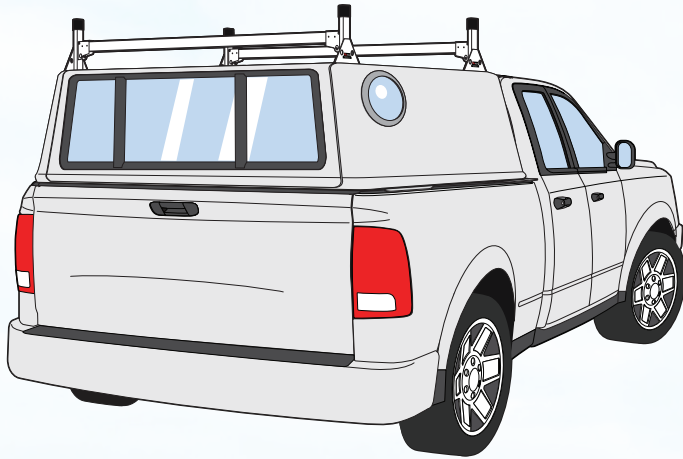

### H1 Rack System

### Description

### Bar Length

### Material

### Color

### Capacity

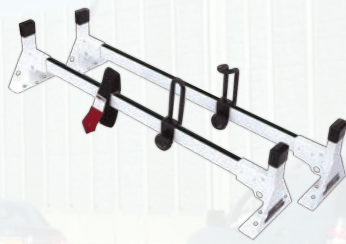

2 Bar System

Included acc.  
1 x Ladder Stopper  
1 x Ladder Guide  
1 x EZ Hook and loop fastener Strap

ST B / W 500 lbs.

42" AL B / W / S 500 lbs.

SS SS 600 lbs.

57" ST B / W 500 lbs.

AL B / W / S 500 lbs.

SS SS 600 lbs.

63" ST B / W 500 lbs.

AL B / W / S 500 lbs.

SS SS 600 lbs.

## H1 Accessories

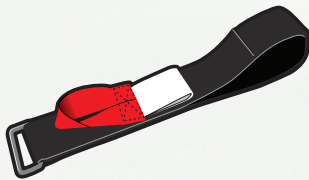

### Part #

A69

### EZ Hook and loop fastener Strap

- › Strap loops onto cross bar
- › Capacity: 75 lbs.
- › Fitment: All Vantech cross bars
- › Material: Nylon
- › Color: Black & red



### Part #

A02

### Ladder Guide

- › Height: 5.5" tall
- › Fitment: H series (1" x 2")
- › Material: Galvanized steel
- › Finish: Black rubber



### Part #

A06

### Ladder Stopper

- › Height: 5" tall
- › Fitment: H series (1" x 2")
- › Material: Galvanized steel
- › Finish: Black rubber

## H1 Accessories

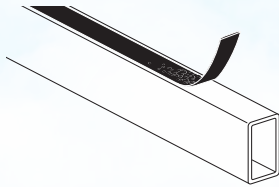

Part #	Length
BG-042	42"
BG-057	57"
BG-063	63"

### Plastic Bar Guard

- Textured plastic surface
- Adhesive backing
- Material: Plastic
- Color: Black

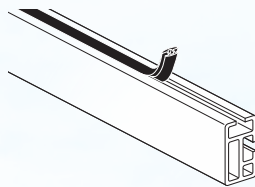

Part #	Length
BG-534	34"
BG-549	49"
BG-555	55"

### Rubber Bar Guard

- Non-slip rubber surface
- Press-In installation method
- Material: Rubber
- Color: Black

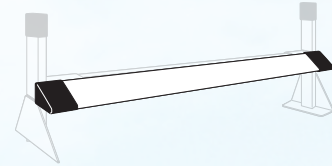

Part #	Length
WF-44	44"
WF-59	59"
WF-65	65"

### Wind Foil

- Decreases wind noise and vibrations
- Material: Aluminum
- Color: Anodized black  
Anodized silver  
Powder coated white

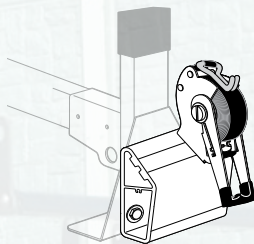

Part #
RTD10-H1

- Ratchet Tie-Down
- Bolt-on system (no drilling required)
- Self contained strap
- Strap: 1.5" x 120"
- Material: Stainless steel

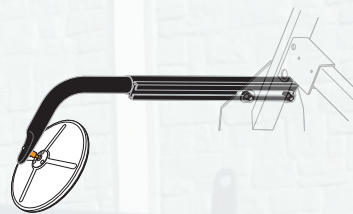

Part #	Adjustment
A81	25"-32"

### Back-Up 8" Convex Mirror

- Installs onto eye hooks
- Material: Aluminum
- Color: Anodized black

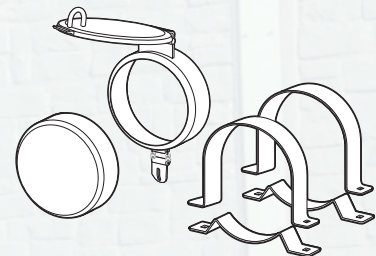

PART #
A40

- 6" Conduit Hatch & Cap
- No drilling required.
- Includes: Cross bar clamps
- Material: Aluminum
- Color: Anodized black  
Anodized silver  
Powder coated white

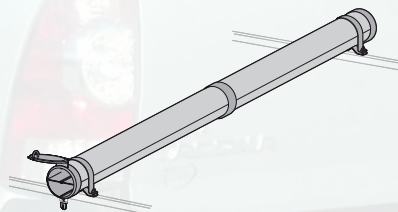

Part #	Description
CC-104	2 Compartment

### 6" x 128" Conduit Carrier Kit

- 3 or 4 compartments available (see page 110)
- Material: Aluminum
- Color: Anodized black  
Anodized silver  
Powder coated white
- Tube only available in silver

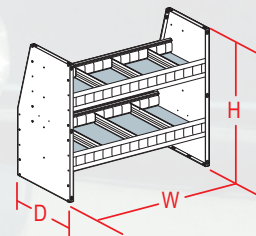

Height	Depth	36"	42"	48"
36"	11"	SA3636-2	SA3642-2	SA3648-2

### Aluminum Interior Shelving

- Material: Aluminum
- Levels: 2
- Color: Silver

## J SERIES RACK SYSTEM

- ▶ Universal system
- ▶ Bolts onto aluminum, steel or fiberglass body
- ▶ Drilling required
- ▶ 2.25" x 1" or 3" x 1.5" cross bars available
- ▶ Cross bar length available from 50" - 72"
- ▶ 4" wide mounting bases
- ▶ Heavy duty 1/8" thick mounting bases
- ▶ Built-in channels on the cross bars for additional accessories
- ▶ 2 x .75" eyehooks per mounting base for easy tie down
- ▶ All aluminum design
- ▶ Colors available: black, white or silver

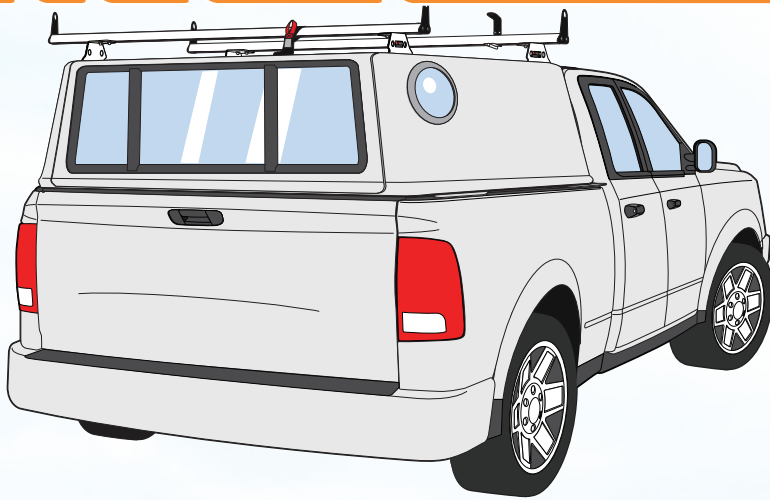

J series Rack System	Description	Cross Bar	Bar Type	Material	Color	Capacity
		50"	A285	Aluminum	B / W / S	400 lbs.
		60"	A285	Aluminum	B / W / S	400 lbs.
	J1000 2 Bar System	55"	A286	Aluminum	B / W / S	500 lbs.
		65"	A286	Aluminum	B / W / S	500 lbs.
		72"	A286	Aluminum	B / W / S	500 lbs.
		50"	A285	Aluminum	B / W / S	400 lbs.
	J2000 2 Bar System	60"	A285	Aluminum	B / W / S	400 lbs.
	Includes: 4 x Side Support 1 x Ladder Stopper 1 x EZ Ladder Stopper	55"	A286	Aluminum	B / W / S	500 lbs.
		65"	A286	Aluminum	B / W / S	500 lbs.
		72"	A286	Aluminum	B / W / S	500 lbs.

## J series Accessories



Part #

A03 / A04

### Side Support

- ▶ Height: 4" tall from top of cross bar
- ▶ Fitment: A03 fits A286 cross bars  
A04 fits A285 cross bars
- ▶ Material: Galvanized steel  
rubber dipped



Part #

A20

### Adjustable Guide

- ▶ Height: 5" tall
- ▶ Fitment: Cross bars with channels
- ▶ Material: Galvanized steel  
rubber dipped

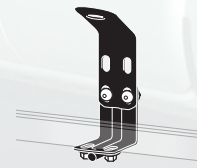

Part #

A57

### Ladder Stopper

- ▶ Height: 5-7" tall
- ▶ Material: Galvanized steel  
rubber dipped
- ▶ Color: Black

## J series Accessories

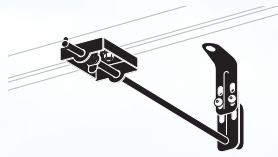

**Part #**

A64

**Push 2 Secure**

- › Secure and lock ladder
- › Material: Galvanized steel rubber dipped
- › Color: Black

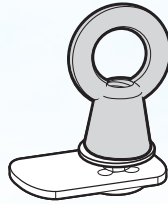

**Part #      Size**

A24      1"  
A59      1.25"

**1" Eye hook**

- › Fitment: Slides into aluminum channels
- › Material: Stainless steel
- › Color: Silver

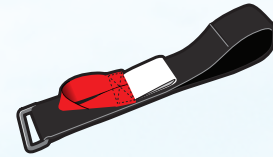

**Part #**

A69

**EZ Hook and loop fastener Strap**

- › Strap loops onto cross bar
- › Capacity: 75 lbs.
- › Fitment: All Vantech cross bars
- › Material: Nylon
- › Color: Black & red

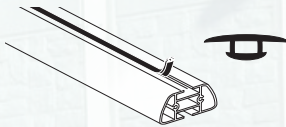

**Part #      Length**

BG-550      34"  
BG-555      49"  
BG-560      55"  
BG-565      65"  
BG-572      72"

**Rubber Bar Guard**

- › Non-slip rubber surface
- › Press-In installation method
- › Fitment: A286 cross bars
- › Material: Rubber
- › Color: Black

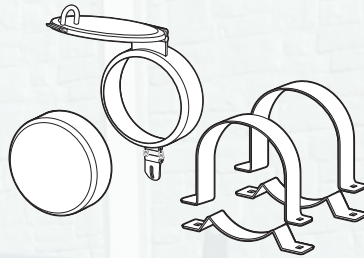

**PART #**

A34

**6" Conduit Hatch & Cap**

- › No drilling required
- › Secures to bars with sliders
- › Material: Aluminum
- › Color: Anodized black  
Anodized silver  
Powder coated white

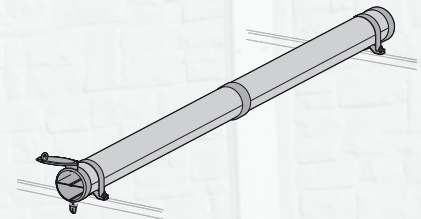

**Part #      Description**

CC-101      2 Compartment

**6" x 128" Conduit Carrier Kit**

- › 3 or 4 compartments available (see page 110)
- › Material: Aluminum
- › Color: Anodized black  
Anodized silver  
Powder coated white
- › Tube only available in silver

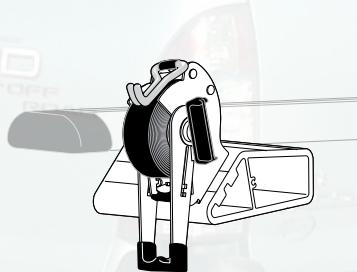

**Part #**

RTD10-H3

- › **Ratchet Tie-Down**
- › Bolt-on system (no drilling required)
- › Self contained strap
- › Strap: 1.5" x 120"
- › Material: Stainless steel

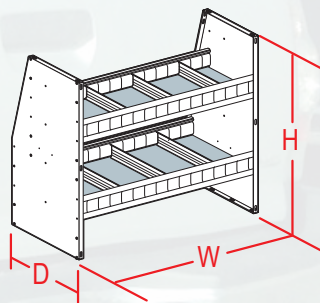

Height	Depth	36"	42"	48"
36"	11"	SA3636-2	SA3642-2	SA3648-2

**Aluminum Interior Shelving**

- › Fitment: Mini Vans/ Hatchback with 36" clearance
- › Material: Aluminum
- › Levels: 2
- › Color: Silver

Vehicle's Roof top

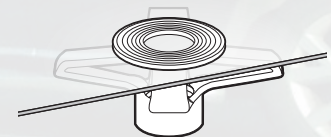

Vehicle's Interior

**Part #**

K059

**Anchor kit (Plus nut)**

- › Install without removing upholstery
- › Qty: Pack of 8
- › Material: Zinc plated steel
- › More options on pg 107

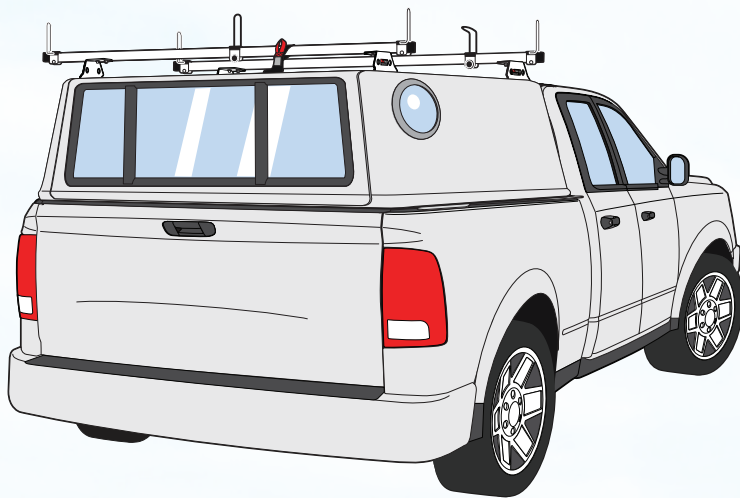

## M SERIES RACK SYSTEM

- › Universal system
- › Bolts onto aluminum, steel or fiberglass body
- › Drilling required
- › Cross bar lengths available 60" - 84"
- › 10.75" total height with support
- › 6" extra wide mounting bases
- › Polyfoam gaskets for tight seal
- › 2 x .75" eyehooks per mounting base for easy tie down
- › Color available: black or white

### STEEL SYSTEM

- › Heavy duty grade
- › Economical

### ALUMINUM SYSTEM

- › Rust free
- › Stainless steel hardware
- › Lightweight

(more info see page 9)

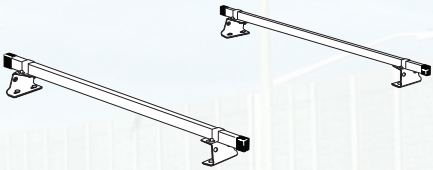
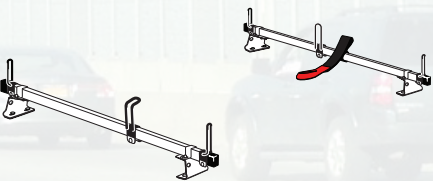
M series Rack System	Description	Width	Color	ST	AL
		60"	B / W	M1010	M1009
	2 Bar M1000 Rack	72"	B / W	M1020	M1019
		84"	B / W	M1030	n/a
	2 Bar M2000 Rack	60"	B / W	M2010	M2009
	Included acc. 4 x Side Support 1 x Ladder Stopper 1 x Ladder Guide				
	1 x EZ Hook and loop fastener Strap	72"	B / W	M2020	M2019

## M series Accessories



Part #

A01

### Ladder Guide

- › Height: 5.5" tall
- › Fitment: M series (1" x 1.5")
- › Material: Galvanized steel
- › Finish: Black rubber



Part #

A05

### Ladder Stopper

- › Height: 5" tall
- › Fitment: M series (1" x 1.5")
- › Material: Galvanized steel
- › Finish: Black rubber



Part #

A09

### Side Support

- › Height: 5.5" tall
- › Fitment: M series (1" x 1.5")
- › Material: Galvanized steel
- › Finish: Black rubber

## M series Accessories



Part #	Length
BG-060	60"
BG-072	72"
BG-084	84"

### Plastic Bar Guard

- › Textured plastic surface
- › Adhesive backing
- › Material: Plastic
- › Color: Black

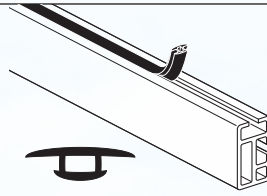

Part #	Length
BG-552	52"
BG-564	72"
BG-576	84"

### Rubber Bar Guard

- › Non-slip rubber surface
- › Press-In installation method
- › Material: Rubber
- › Color: Black

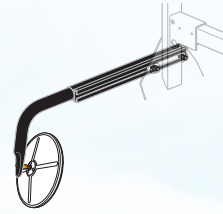

### Part#

A82

### Back-Up 8" Convex Mirror

- › Installs onto eye hooks
- › Material: Aluminum
- › Color: Anodized black

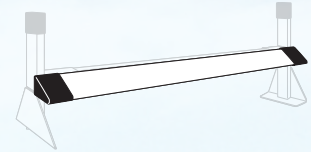

Part #	Length
BG-060	60"
BG-072	72"
BG-084	84"

### Wind Foil

- › Reduce wind noise and vibrations
- › Material: Aluminum
- › Color: Anodized black  
Anodized silver  
Powder coated white

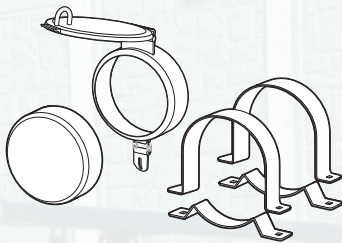

### PART #

A37

- › **6" Conduit Hatch & Cap**
- › No drilling required.
- › Includes: Cross bar clamps
- › Material: Aluminum
- › Color: Anodized black  
Anodized silver  
Powder coated white

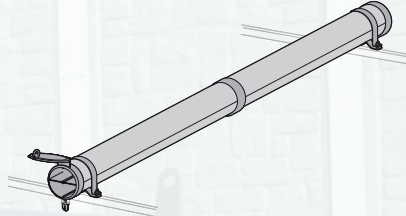

### Part # Description

CC-103 2 Compartment

- › **6" x 128" Conduit Carrier Kit**
- › 3 or 4 compartments available (see page 110)
- › Material: Aluminum
- › Color: Anodized black  
Anodized silver  
Powder coated white
- › Tube only available in silver

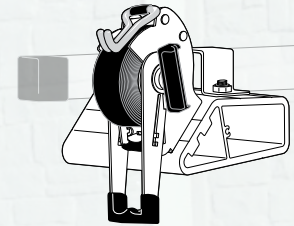

### Part #

RTD10-M

- › **Ratchet Tie-Down**
- › Bolt-on system (no drilling required)
- › Self contained strap
- › Strap: 1.5" x 120"
- › Material: Stainless steel/Aluminum

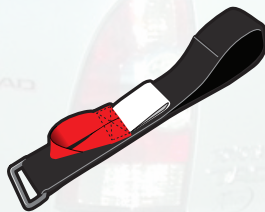

### Part #

A69

### EZ Hook and loop fastener Strap

- › Strap loops onto cross bar
- › Capacity: 75 lbs.
- › Fitment: All Vantech cross bars
- › Material: Nylon
- › Color: Black & red

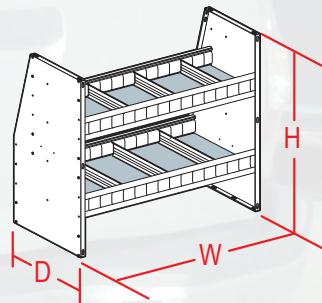

Height	Depth	36"	42"	48"
36"	11"	SA3636-2	SA3642-2	SA3648-2

### Aluminum Interior Shelving

- › Fitment: Mini vans/ hatchback with 36" clearance
- › Material: Aluminum
- › Levels: 2
- › Color: Silver

Vehicle's roof top

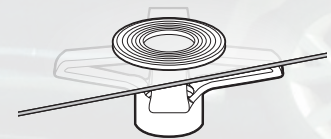

Vehicle's interior

### Part #

K059

### Anchor kit (Plus nut)

- › Install without removing upholstery
- › Qty: Pack of 8
- › Material: Zinc plated steel
- › More options on pg 107



### LADDER GUIDE (RECTANGULAR CROSS BARS)



- › Prevent ladder from shifting
- › Prevent side to side motion
- › Easily secure bungees and tie-downs
- › Easy turn knob allows for quick adjustment and removal
- › Galvanized and dipped in rubber for extra durability
- › 5.5" clearance from top of cross bar

Fitment	Bar Type
M Series	1" x 1.5"
H1 Series	1" x 2"

### LADDER STOPPER (RECTANGULAR CROSS BARS)



- › Prevent forward, up and down motion of ladders
- › Easily secure bungees and tie-downs
- › Easy turn knob allows for quick adjustment and removal
- › Galvanized and dipped in rubber for durability
- › 5" clearance from top of cross bar

Fitment	Bar Type
M Series	1" x 1.5"
H1 Series	1" x 2"

### SIDE SUPPORT (RECTANGULAR CROSS BARS)



- › Prevents objects from sliding off the ends of the cross bar
- › Easily secure bungees and tie-downs
- › Galvanized and dipped in rubber for durability
- › 5.5" clearance from top of cross bar

Fitment	Fitment
M Series	1" x 1.5"

### ADJUSTABLE GUIDE (ALUMINUM CHANNELS)



- › Secures objects from shifting side to side on top of the cross bar
- › The adjustable guide slides inside the channels of the cross bar and locks into place with a turn-knob
- › Eye hook located on top to secure tie-downs and bungees
- › Galvanized and dipped in rubber for durability
- › 5" clearance from top of cross bar

Fitment	Bar Type
J / H2 / H3 / P3000 Series	Aluminum channels

### LADDER STOPPER (ALUMINUM CHANNELS)



- › Prevent forward, up and down motion of ladders
- › The unit is bolted onto the bottom channels of the cross bar
- › Galvanized and dipped in rubber for durability
- › 5-7" clearance from top of cross bar

Fitment	Bar Type
J / H2 / H3 / P3000 Series	Aluminum channels

### SIDE SUPPORT (RECTANGULAR CROSS BARS)



- › Prevents objects from sliding off the ends of the cross bar
- › Easily secure bungee and tie-downs
- › Galvanized and dipped in rubber for durability
- › Includes stainless steel mounting hardware
- › Galvanized and dipped in rubber for durability
- › 4" clearance from top of cross bar

Fitment	Bar Type
J series	A285
J / H2 / H3 / P3000 Series	A286

## PUSH 2 SECURE (RECTANGULAR CROSS BARS)



- › Secure and lock ladder
- › Clamps onto cross bar with "C" clamps
- › Holds ladders 5 - 7" height
- › Galvanized and dipped in rubber for extra durability.

Fitment	Bar Type
M Series	1" x 1.5"
H1 Series	1" x 2"

## PUSH 2 SECURE (ALUMINUM CHANNELS)



- › Secure and lock ladder
- › Fits into extruded aluminum cross bars
- › Holds ladder 5 - 7" height
- › Galvanized and dipped in rubber for extra durability.

Fitment	Bar Type
J / H2 / H3 / P3000 Series	Aluminum Channels

## EYE HOOK (ALUMINUM CHANNELS)



- › Slides into aluminum channels
- › Easily tie down objects with bungees and tie-downs

Fitment	I.D.
J / H2 / H3 / P3000 Series	1"
J / H2 / H3 / P3000 Series	1.25"

## EZ-HOOK AND LOOP FASTENER STRAP (UNIVERSAL)

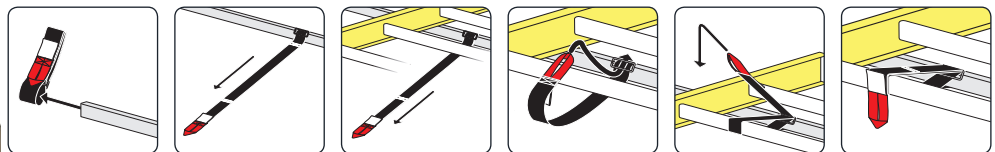
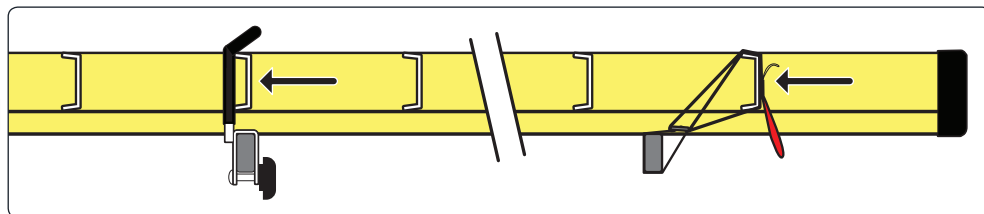

- › Maximum weight capacity of 75 lbs. when used in combination with ladder stopper or ladder guide (4" minimum contact surface required)
- › Strap loops onto cross bar
- › 31.5" long from end to end
- › Material: Nylon

Bar Type	Weight Limit
Fits all Vantech Cross Bars	75 lbs

### PLASTIC BAR GUARD (RECTANGULAR CROSS BARS)

- Fits Surfaces without Channel

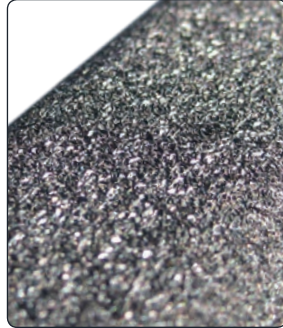

- .75" plastic bar guards
- Adhesive backing
- Extends life of cross bars
- Can be cut to specific sizes

Width	Length
.75"	39"
.75"	42"
.75"	56"
.75"	63"
.75"	72"
.75"	84"
.75"	96"

### RUBBER BAR GUARD (ALUMINUM CHANNELS)

- Surfaces with Channel



- Protects cross bars
- Fits into channels of extruded aluminum bars
- Easy press-on design
- Can be cut to specific sizes
- Minimizes rattling sound from equipment
- Prevents whistling and wind noise
- Prevents vibrations

Width	Length
.75"	31"
.75"	34"
.75"	48"
.75"	65"
.75"	72"
.75"	84"
.75"	96"

### BAR GUARD "CUSHION" (ALUMINUM CHANNELS)

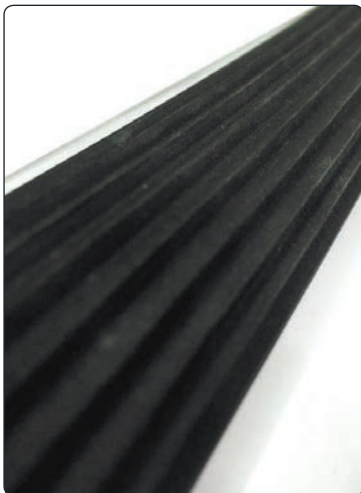

Width	Length
1"	48"
1"	65"
1"	72"
1"	84"
1"	96"

- Cushioned rubber bar guards
- Fits into channels of extruded aluminum bars
- Pocket design for extra cushion
- Great for kayaks, surfboards etc.
- Can be cut to specific size

## WIND FOILS (RECTANGULAR CROSS BARS)



- Reduces wind noise and vibration
- Designed to allow additional accessories to be used on the cross bar.
- Fits onto M series or H1 Rack Systems
- Available in black or white
- Material: Aluminum

### Width

---

36"

---

48"

---

60"

---

63"

## KAYAK HOLDER (ALUMINUM CHANNELS)



- Holds kayaks, surfboards and canoes
- Adjustable rubber padding conforms to the shape of the equipment
- Includes straps with rubber padding
- Capacity: 100 lbs.

### Description

---

4 pcs. holder  
with straps  
(Holds 1 equipment)

## PLUS NUT UPGRADE KIT



- Drilling required
- Install mounting bases onto the roof of vehicle without removal of the interior upholstery
- Kit includes plus nuts, hex bolts, washers and lock tool

### Thread

---

1/4"

---

1/4"

---

5/16"

---

5/16"

### Qty

---

Set of 8

---

Set of 12

---

Set of 8

---

Set of 12

- Insert plus nut into vehicle

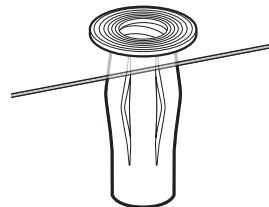

- Expands plus nut to anchor into vehicle

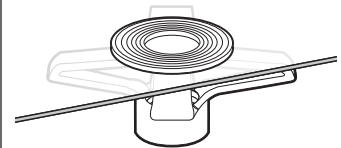

## MIRROR



- Installs onto eye hooks of mounting base
- Adjustable 8" wide convex mirror
- No drilling required
- Extendable arm 25"-32"
- Available in anodized black only

### Fitment

---

H1 Series

---

M Series

# Track System

## MERCEDES / DODGE SPRINTER 2007-ON

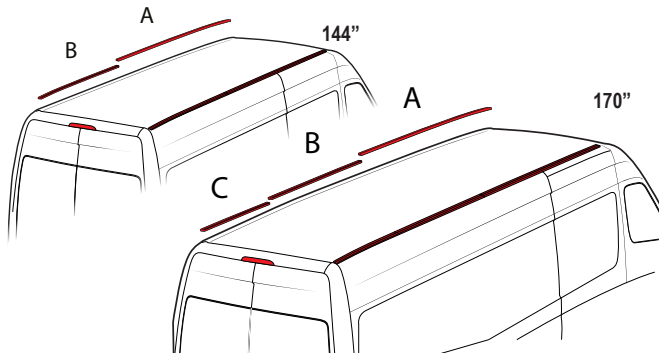

Description	Length	Quantity	Material
2 Piece Track (A,B)	144 Wheelbase	2 Pair	Aluminum
3 Piece Track (A,B,C)	170 Wheelbase	3 Pair	Aluminum
1 Piece Track (A)	72"	1 Pair	Aluminum
1 Piece Track (B)	51"	1 Pair	Aluminum
1 Piece Track (C)	40"	1 Pair	Aluminum

- › Bolts onto factory mounting points
- › No drilling required
- › Evenly distributes weight when used with rack system
- › Fit standard, high and super high roof sprinters

## FORD TRANSIT CONNECT 2008-13/2014-NEWER

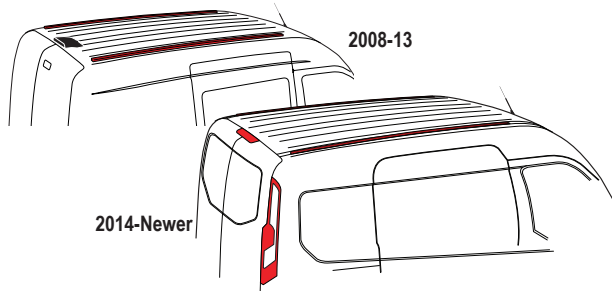

Description	Fitment	Quantity	Material
1 Piece Track	2008-13	1 Pair	Aluminum
1 Piece Track	2014-Newer XL	1 Pair	Aluminum
1 Piece Track	2014-Newer XLT	1 Pair	Aluminum

- › Bolts onto factory mounting points
- › 2 x additional holes to secure with plus nut (drilling required)
- › Position racks and accessories at desired points
- › Evenly distributes weight when used with rack system

## HONDA RIDGELINE

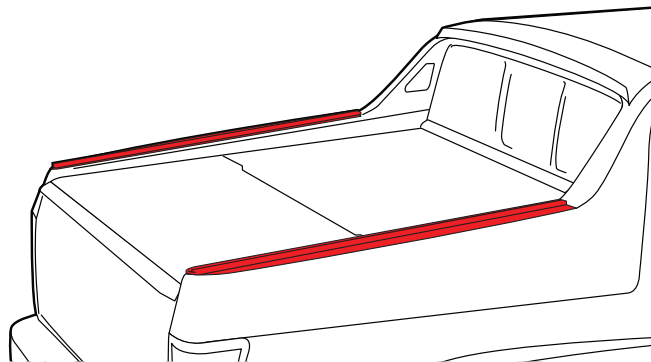

Description	Fitment	Quantity	Material
Passenger Bed rail adaptor	2005-16	1 Piece	Aluminum
Driver Bed rail adaptor	2005-16	1 Piece	Aluminum
Passenger Bed rail adaptor	2017-On	1 Piece	Aluminum
Driver Bed rail adaptor	2017-On	1 Piece	Aluminum

- › Bolts onto factory slots
- › Includes all hardware to secure bed rail adaptor onto vehicle
- › No drilling required
- › Modification required on factory plastic bed rail covers

## UNIVERSAL

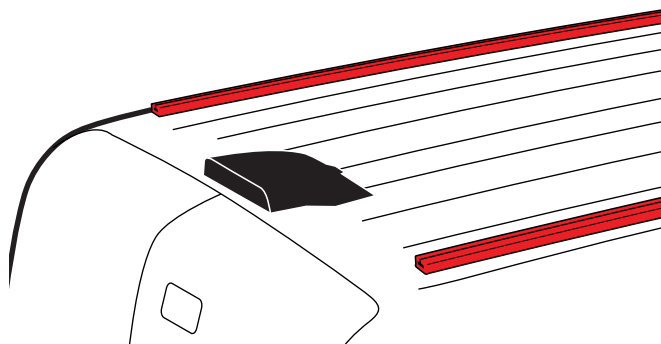

Description	Length	Quantity	Material
Track	48"	1 pair	Aluminum
	60"	1 pair	Aluminum
	72"	1 pair	Aluminum

- › Universal fitment (drilling required)
- › Allows rack systems to be placed at various distances
- › Evenly distributes weight when used with rack system
- › Gasket and hardware included

## Rear Access Ladder

- ▶ All aluminium design
- ▶ Available in black, white or silver
- ▶ Adjustable arms to fit curvature of surface
- ▶ Weight Capacity: 250 lbs.



- (a) Adjustable mounting points  
Angled to contour of surface
- (b) Depth adjustable up to 4-6"
- (c) 12" Ladder rung with ridges for better traction

Description	Fitment	Color
56" Angled ladder	Fullsize Vehicles Transit Connect All Years	B / W / S
68" Angled ladder	Low Roof Vehicles	B / W / S
83" Angled ladder	High Roof Vehicles	B / W / S
72" Straight Ladder	Box Trucks / Trailer / RV	B / W / S
84" Straight Ladder	Box Trucks / Trailer / RV	B / W / S
96" Straight Ladder	Box Trucks / Trailer / RV	B / W / S



# Conduit Carrier

## CONDUIT CARRIER CAP & HATCH



- › Conduit cap and hatch are made from 5052 Aluminum
- › Fits standard 6" PVC pipes
- › Hatch can be secured with lock (not included)
- › Hardware included

Description	Fitment	Color
Conduit Carrier Cap, Hatch & Mounts	H2 / H3 / J series / P series	B / W / S
	Universal Drill Thru	B / W / S
	M series 1" x 1.5"	B / W / S
	H series 1" x 2"	B / W / S

## CONDUIT CARRIER WITH COMPARTMENT TUBE

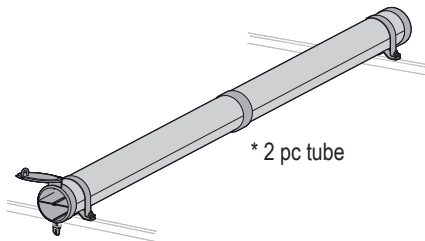

Dividers can be added for additional compartments

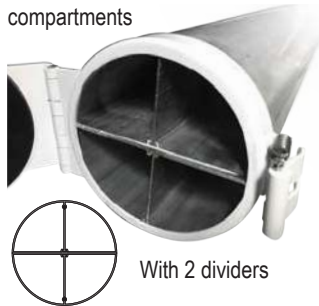

- › Conduit cap and hatch are made from 5052 Aluminum
- › Tube is made from 6061 aircraft grade aluminum
- › 2mm thick tube walls
- › 2 semi-circle compartments
- › Additional divider available to create 4 compartments
- › 6" diameter tube
- › 128" long tube

Description	Fitment	Color	2 Piece Tube	1Piece Tube
Conduit Carrier Cap, Hatch & Mounts with 128" Tube	H2 / H3 / J series / P series	B / W / S	CC-101	CC-201
	Universal Drill Thru	B / W / S	CC-102	CC-202
	M series	B / W / S	CC-103	CC-203
	H series	B / W / S	CC-104	CC-204
64" Divider (2 pieces)	n/a	S		

## Shelving

### MIDSIZE VANS

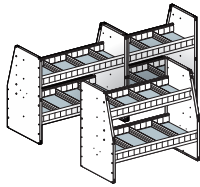

Description	Height	Depth	Levels	Width	Divider	
Angled Shelving Unit	36"	14"	2	42"	4	SA3642-2
				48"	6	SA3648-2
				60"	8	SA3660-2

### TRANSIT CONNECT 2008-ON

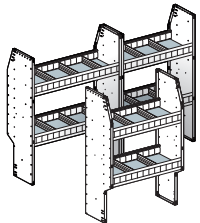

Description	Height	Depth	Levels	Width	Divider	
Angled Shelving Unit	46"	11"	2	36"	4	SA4642-2
				60"	8	SA4660-2

### LOW ROOF

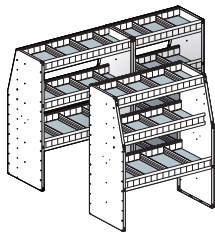

Description	Height	Depth	Levels	Width	Divider	
Angled Shelving Unit	48"	14"	3	42"	6	SA4842-3
				48"	9	SA4848-3
				60"	12	SA4860-3
				72"	15	SA4872-3
				84"	18	SA4884-3
				96"	21	SA4896-3

### HIGH ROOF

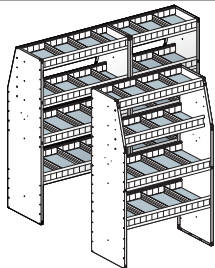

Description	Height	Depth	Levels	Width	Divider	
Angled Shelving Unit	60"	14"	4	42"	8	SA6042-4
				48"	12	SA6048-4
				60"	16	SA6060-4
				72"	20	SA6072-3
				84"	24	SA6084-3
				96"	28	SA6096-3

### BOX TRUCK

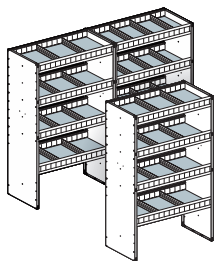

Description	Height	Depth	Levels	Width	Divider	
Straight Shelving Unit	60"	14"	4	42"	8	SS6042-4
				48"	12	SS6048-4
				60"	16	SS6060-4
				72"	20	SS6072-4
				84"	24	SS6084-3
				96"	28	SS6096-3

### PLATFORMS & DIVIDERS

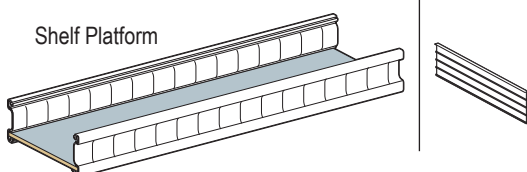

Part #	Width	9" Deep	11" Deep	14" Deep
Shelf Platform	42"	SHF09-42	SHF11-42	SHF14-42
	48"	SHF09-48	SHF11-48	SHF14-48
	60"	SHF09-60	SHF11-60	SHF14-60
	72"	SHF09-72	SHF11-72	SHF14-72
	84"	SHF09-84	SHF11-84	SHF14-84
	96"	SHF09-96	SHF11-96	SHF14-96
Divider	n/a	SDV09	SDV11	SDV14



# Roller System

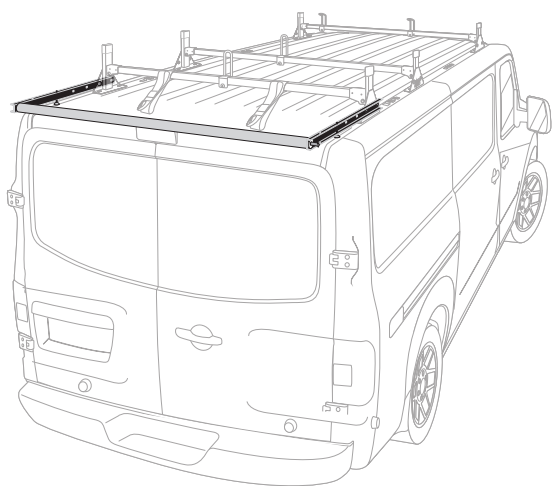
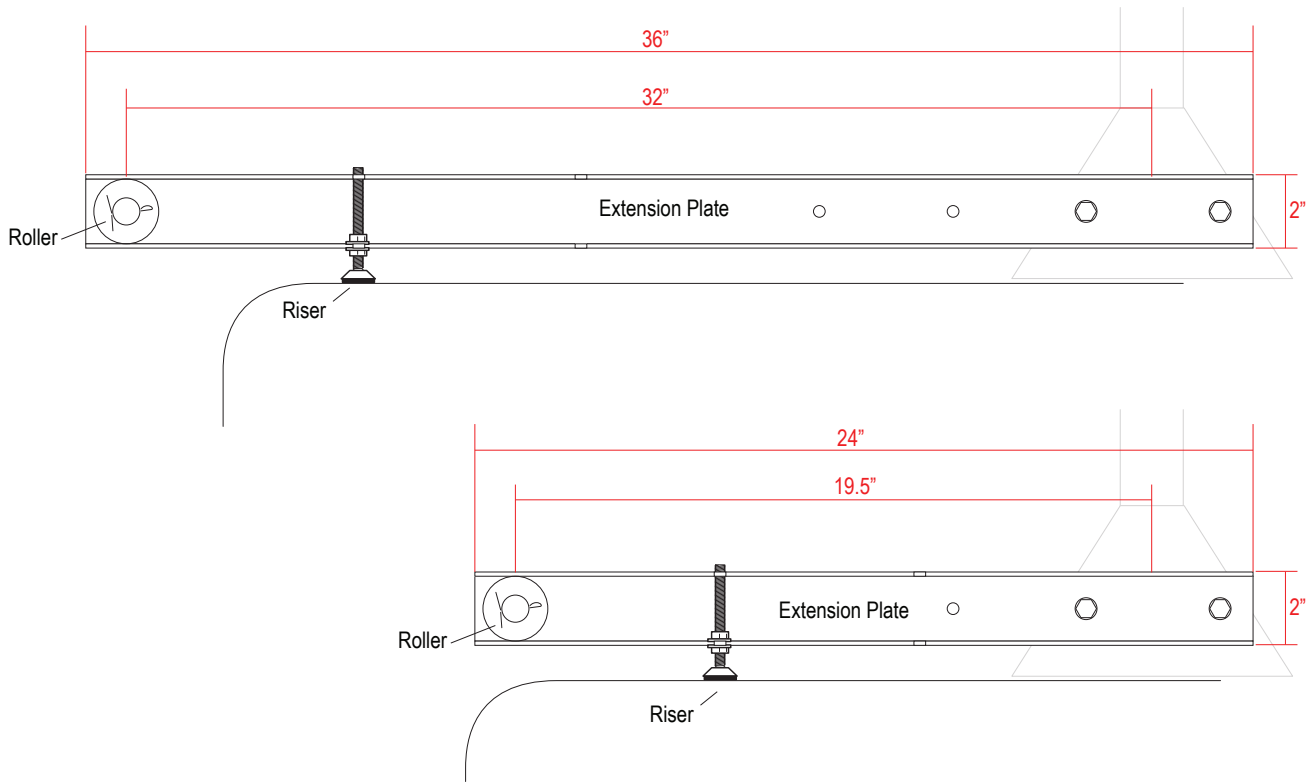

Fitment	Max Extension	Color	Roller	
H1	24"	B / W / S	45"	ROH124-45
H1	24"	B / W / S	47"	ROH124-47
H1	24"	B / W / S	54"	ROH124-54
H1	24"	B / W / S	57"	ROH124-57
H1	24"	B / W / S	60"	ROH124-60
H1	24"	B / W / S	63"	ROH124-63
H1	36"	B / W / S	47"	ROH136-47
H1	36"	B / W / S	60"	ROH136-60

- › Rear roller allows easy loading and unloading
- › Fits eye hooks on the H1 mounting bases
- › Reinforced extruded aluminum roller
- › Roller only available in silver
- › Includes adjustable riser
- › Color: Anodized Black  
Anodized Silver  
Powder coated white

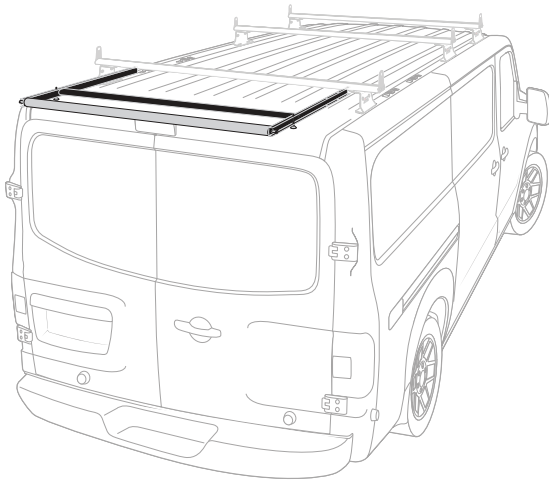
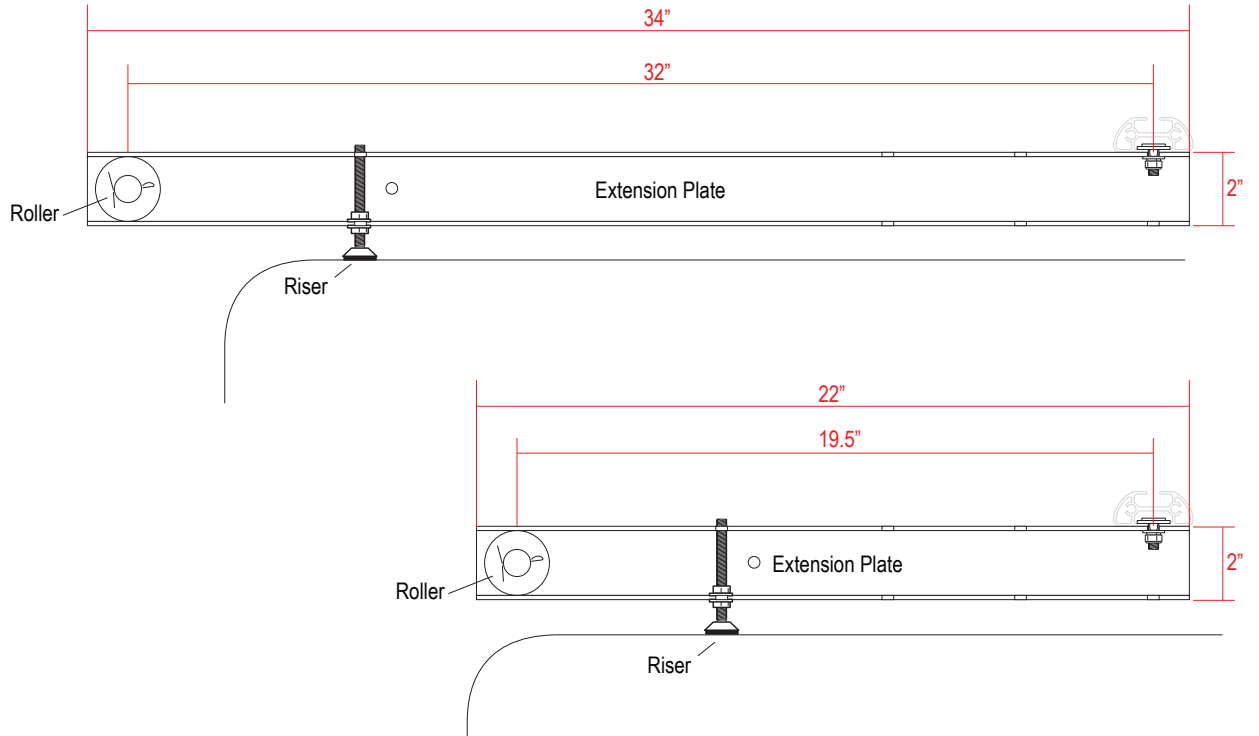

- › Rear roller allows easy loading and unloading
- › Fits A285 & A286 crossbars
- › Reinforced extruded aluminum roller
- › Roller only available in silver
- › Includes adjustable riser
- › Color: Anodized Black  
Anodized Silver  
Powder coated white

Fitment	Max Extension	Color	Roller
H3 / J Series	22"	B / W / S	36" ROH322-36
H3 / J Series	34"	B / W / S	36" ROH334-36
H3 / J Series	22"	B / W / S	50" ROH322-50
H3 / J Series	34"	B / W / S	50" ROH334-50

# Ratchet-Tie-Down

## H1 RATCHET TIE DOWN KIT

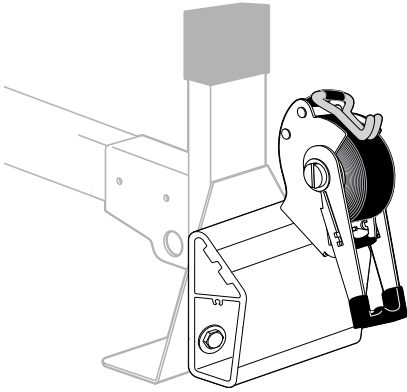

- › H1 Kit
- › Secures to H1 Mounting base eyehook
- › Strap: 1.5" X 120"
- › Material: Stainless Steel / Aluminum
- › Compatible with roller system
- › Self contained strap

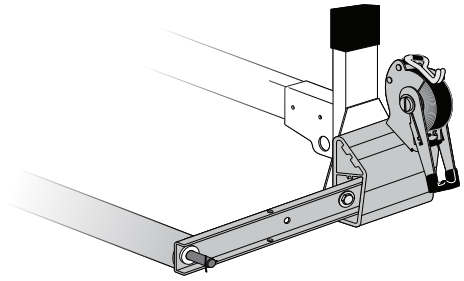

Part #	Description	Fitment
RTDH1K	Ratchet-Tie-Down Unit for Rack Systems with 1" X 2" Cross Bars	H1

## H2 RATCHET TIE DOWN KIT

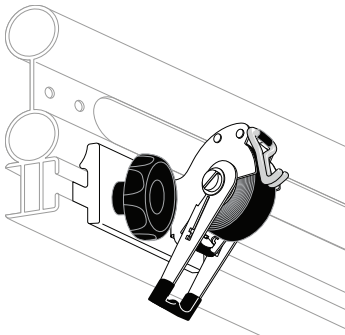

- › H2 Kit
- › Secures to cargo rail channels
- › Strap: 1.5" X 120"
- › Twist knob adjustable
- › Material: Stainless Steel / Aluminum
- › Self contained strap

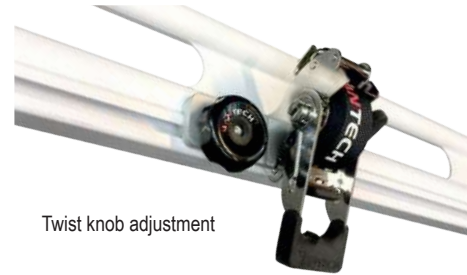

Part #	Description	Fitment
RTDH2K	Ratchet-Tie-Down Unit (Only fits H2 Cargo Rails)	H2

## H3 / J SERIES / P SERIES RATCHET TIE DOWN KIT

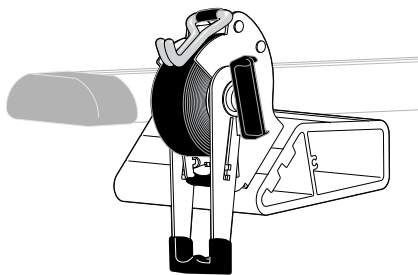

- › H3 Kit
- › Secures to cross bar channel
- › Strap: 1.5" X 120"
- › Fits A285 and A286 Cross Bars
- › Material: Stainless Steel / Aluminum
- › Self contained strap

Part #	Description	Fitment
RTDH3K	Ratchet-Tie-Down Unit for Rack Systems with A285 & A286 Cross Bars	J1000 / J2000 / J3000 / J4000 / H3 / P3000

## M SERIES RATCHET TIE DOWN KIT

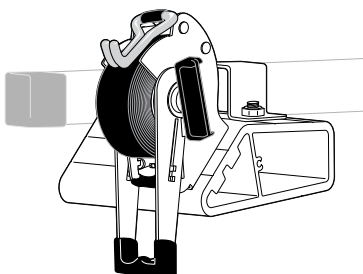

- › M Series Kit
- › Clamps onto cross bar
- › Strap: 1.5" X 120"
- › Fits 1" X 1.5" Cross Bars
- › Material: Stainless Steel / Aluminum
- › Self contained strap

Part #	Description	Fitment
RTDM1K	Ratchet-Tie-Down Unit for Rack Systems with 1" X 1.5" Cross Bars	M1000 / M2000 / M3000 / M4000

## Rectangular Cross Bars



A100  
A333

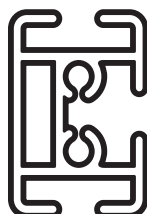

A374  
A350



A500  
A316



A613

Description	Length	Width	Height	Material	Color	
Cross Bar A100 (Straight)	50"	1"	1.5"	Steel	B / W	A100-50
Cross Bar A100 (Straight)	60"	1"	1.5"	Steel	B / W	A100-60
Cross Bar A100 (Straight)	72"	1"	1.5"	Steel	B / W	A100-72
Cross Bar A100 (Straight)	84"	1"	1.5"	Steel	B / W	A100-84
Cross Bar A374 (Straight)	50"	1"	1.5"	Aluminum	B / W / S	A374-50
Cross Bar A374 (Straight)	60"	1"	1.5"	Aluminum	B / W / S	A374-60
Cross Bar A374 (Straight)	72"	1"	1.5"	Aluminum	B / W / S	A374-72
Cross Bar A333 (Angled)	60"	1"	1.5"	Steel	B / W	A333-60
Cross Bar A350 (Angled)	60"	1"	1.5"	Aluminum	B / W	A350-60
Cross Bar A500	39"	1"	2"	Steel	B / W	A500-39
Cross Bar A500	45"	1"	2"	Steel	B / W	A500-45
Cross Bar A500	52"	1"	2"	Steel	B / W	A500-52
Cross Bar A500	53"	1"	2"	Steel	B / W	A500-53
Cross Bar A500	54"	1"	2"	Steel	B / W	A500-54
Cross Bar A500	56"	1"	2"	Steel	B / W	A500-56
Cross Bar A500	57"	1"	2"	Steel	B / W	A500-57
Cross Bar A500	62"	1"	2"	Steel	B / W	A500-62
Cross Bar A500	63"	1"	2"	Steel	B / W	A500-63
Cross Bar A500	72"	1"	2"	Steel	B / W	A500-72
Cross Bar A500	84"	1"	2"	Steel	B / W	A500-84
Cross Bar A500	96"	1"	2"	Steel	B / W	A500-96
Cross Bar A316	52"	1"	2"	Stainless	Polished	A316-52
Cross Bar A316	53"	1"	2"	Stainless	Polished	A316-53
Cross Bar A316	56"	1"	2"	Stainless	Polished	A316-56
Cross Bar A316	57"	1"	2"	Stainless	Polished	A316-57
Cross Bar A316	62"	1"	2"	Stainless	Polished	A316-62
Cross Bar A316	63"	1"	2"	Stainless	Polished	A316-63
Cross Bar A316	65"	1"	2"	Stainless	Polished	A316-65
Cross Bar A613	39"	1"	2"	Aluminum	B / W / S	A613-39
Cross Bar A613	45"	1"	2"	Aluminum	B / W / S	A613-45
Cross Bar A613	52"	1"	2"	Aluminum	B / W / S	A613-52
Cross Bar A613	53"	1"	2"	Aluminum	B / W / S	A613-53
Cross Bar A613	54"	1"	2"	Aluminum	B / W / S	A613-54
Cross Bar A613	56"	1"	2"	Aluminum	B / W / S	A613-56
Cross Bar A613	57"	1"	2"	Aluminum	B / W / S	A613-57
Cross Bar A613	62"	1"	2"	Aluminum	B / W / S	A613-62
Cross Bar A613	63"	1"	2"	Aluminum	B / W / S	A613-63
Cross Bar A613	72"	1"	2"	Aluminum	B / W / S	A613-72
Cross Bar A613	84"	1"	2"	Aluminum	B / W / S	A613-84
Cross Bar A613	96"	1"	2"	Aluminum	B / W / S	A613-96

## Extruded Aluminum Cross Bars (with channels)

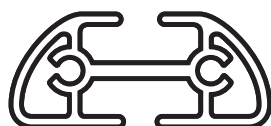

A285

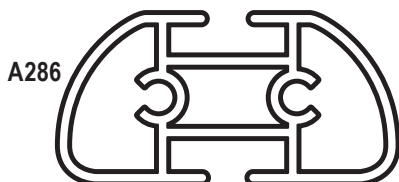

A286

Description	Length	Width	Height	Material	Color	
Cross Bar (A285)	50"	2.25"	1"	Aluminum	B / W / S	A285-50
Cross Bar (A285)	60"	2.25"	1"	Aluminum	B / W / S	A285-60
Cross Bar (A285)	65"	2.25"	1"	Aluminum	B / W / S	A285-65
Cross Bar (A286)	55"	3"	1.5"	Aluminum	B / W / S	A286-55
Cross Bar (A286)	65"	3"	1.5"	Aluminum	B / W / S	A286-65
Cross Bar (A286)	72"	3"	1.5"	Aluminum	B / W / S	A286-72
Cross Bar (A286)	84"	3"	1.5"	Aluminum	B / W / S	A286-84

## Mounts (Replacement Parts)

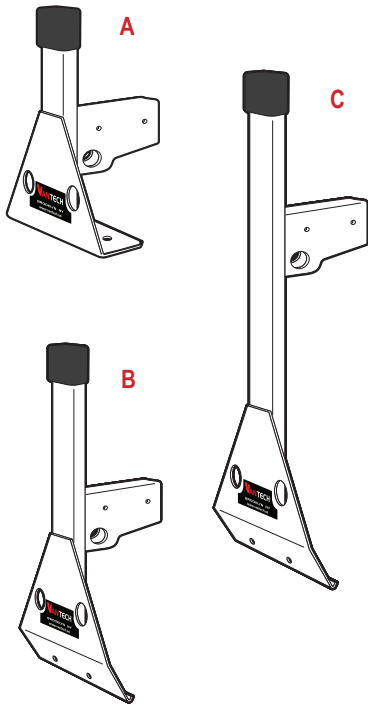

Description	Figure	Bar Height	Foot Print	Color	Material	
Low Profile H1 Mount (Low)	A	2 7/8"	8" x 2"	B / W	Steel	H31
Low Profile H1 Mount (High)	A	3.5"	8" x 2"	B / W	Steel	H33
Standard Height H1 Mount (Low)	B	6 3/8"	8"	B / W	Steel	H03
Standard Height H1 Mount (High)	B	7"	8"	B / W	Steel	H04
High Profile H1 Mount (High)	C	14"	8"	B / W	Steel	H05
Low Profile H1 Mount (Low)	A	2 7/8"	8" x 2"	B / W / S	Aluminum	H32
Low Profile H1 Mount (Low)	A	3.5"	8" x 2"	B / W / S	Aluminum	H34
Standard Height H1 Mount (Low)	B	6 3/8"	8"	B / W	Aluminum	H08
Standard Height H1 Mount (High)	B	7"	8"	B / W	Aluminum	H09
High Profile H1 Mount (High)	C	14"	8"	B / W	Aluminum	H10
Low Profile H1 Mount (Low)	A	2 7/8"	8" x 2"	SS	Stainless	H35
Low Profile H1 Mount (High)	A	3.5"	8" x 2"	SS	Stainless	H39
Standard Height H1 Mount (Low)	B	6 3/8"	8" x 2"	SS	Stainless	H36
Standard Height H1 Mount (High)	B	7"	8" x 2"	SS	Stainless	H37

• Note: Hardware not included

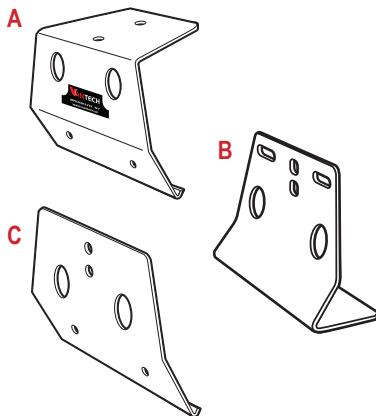

Description	Figure	Clearance	Foot Print	Color	Material	
H3 Upright Mount 5"	A	5"	8"	B / W	Aluminum	H16
H3 Upright Mount 5.5"	A	5.5"	8"	B / W	Aluminum	H17
H2 Universal Mount	B	5"	6" x 1.5"	B	Stainless	H25
H2 Upright Mount 5"	C	5.5"	8"	B / W	Stainless	H26

• Note: Hardware not included

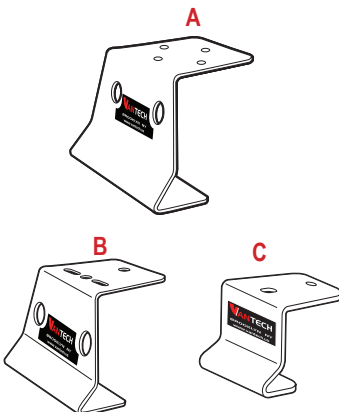
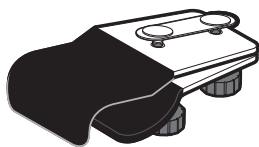

Figure	Description	Width	Height	Material	Color	
A	Mounting Base	6"	3.5"	Steel	B / W	M01
A	Mounting Base	6"	3.5"	Aluminum	B / W	M08
B	Mounting Base	4"	2.5"	Aluminum	B / W	M13
C	Mounting Base	2.75"	2.25"	Aluminum	B / W	M11-2
C	Mounting Base	2.75"	2.75"	Aluminum	B / W	M11

• Note: Gaskets included  
Hardware not included



Description	Material	Color
OE Mount Top & Bottom	Aluminum (rubber dipped)	B

› Note: Hardware not included

## Interior Plates (Replacement Parts)

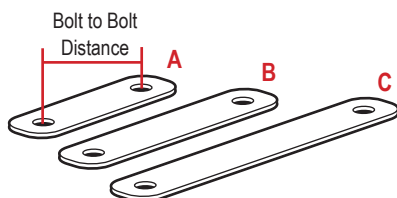

Description	Figure	Bolt to Bolt	Material	Finish
Interior Plate 1" wide	A	3"	Steel	Galvanized M07
Interior Plate 1" wide	B	4"	Steel	Galvanized M03
Interior Plate 1" wide	C	5"	Steel	Galvanized M04

› Note: Hardware not included

## Clamps (Replacement Parts)



Part #	Description	Bolt to Bolt	Bar Fitment	Material	Color
M05	C-Clamp Rectangular Bars	2.25"	1" x 1.5"	Steel	B / W M05
M09	C-Clamp Rectangular Bars	2.25"	1" x 1.5"	Aluminum	B / W M09
H15	C-Clamp Rectangular Bars	2.25"	1" x 2"	Steel	B H15

› Note: Hardware not included



Description	Size	Fitment	Color	Material
Drip Rail Clamps	8" x 2"	Gutter Rails	B / W	Steel H11
Drip Rail Clamps	8" x 2"	Gutter Rails	SS	Stainless H12

› Note: Hardware included

## Adaptors (Replacement Parts)

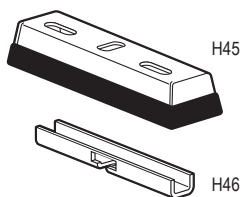

Description	Material
ProMaster Adaptor (Top)	Stainless H45
ProMaster Adaptor (Bottom)	Stainless H46
ProMaster Adaptor (Top & Bottom)	Stainless H45-46

› Note: Hardware included

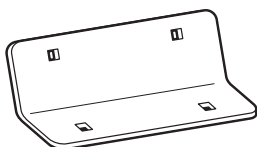

Description	Size	Fitment	Color	Material
43° Adaptor Plate for H1/H3	1.5" x 8"	H1/H3	B / W	Steel H13
43° Adaptor Plate for H1/H3	1.5" x 8"	H1/H3	B / W	Aluminum H14
53° Adaptor Plate for H1/H3 (KUV Body)	1.5" x 8"	H1/H3	B / W	Aluminum H41

› Note: Hardware not included

## P Series (Replacement Parts)

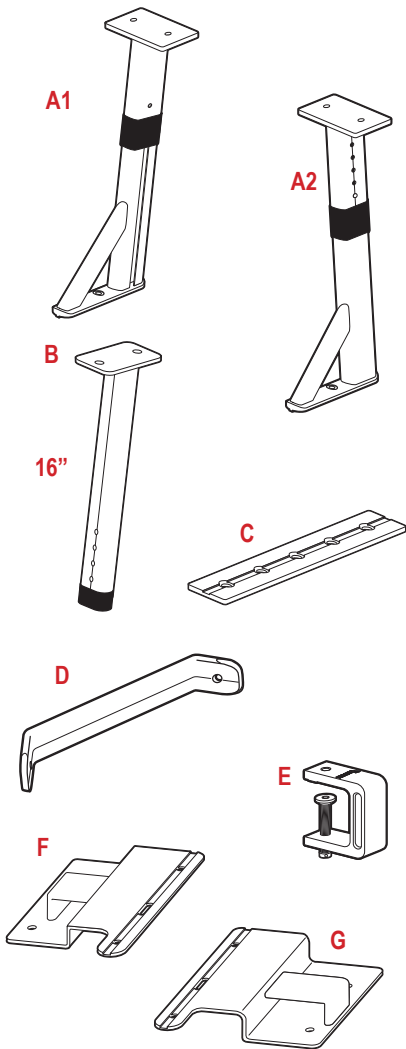

Description	Figure	Material	Color	
Adjustable P3000 Upright 21.25"-28.25" (Driver Side)	A1	Aluminum	B / S	P131
Adjustable P3000 Upright 21.25"-28.25" (Passenger Side)	A2	Aluminum	B / S	P132
P3000 Extension Top Piece	B	Aluminum	B / S	P141
P3000 Base Plate	C	Aluminum	B / S	P012
Pickup Angle Brace	D	Aluminum	B / S	P013
Heavy Duty Pickup Clamps for P3000 Systems	E	Aluminum	B	P031
Chevy Avalanche Grab Handle Replacement (Passenger Side)	F	Aluminum	B	P022
Chevy Avalanche Grab Handle Replacement (Driver Side)	G	Aluminum	B	P021

› Note: Hardware not included

## Endcaps (Replacement Parts)

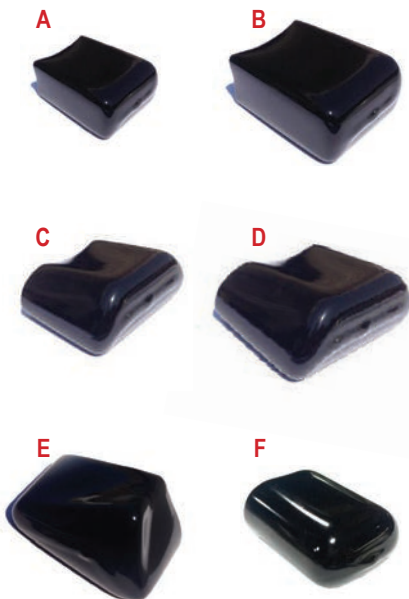

Fitment	Figure	Bar Type	Material	
1" x 1.5" Endcap (M series)	A	A100 A333 A350 A374	Black Rubber	Z100
1" x 2" Endcap (H1)	B	A500 A316 A613	Black Rubber	Z500
Aluminum Bar Endcap (1.25" x 1")	C	A285	Black Rubber	Z285
Aluminum Bar Endcap (3" x 1.5")	D	A286	Black Rubber	Z286
Windfoil Driver-side Endcap	E	A304	Black Rubber	Z304-L
Windfoil Pass-side Endcap	E	A304	Black Rubber	Z304-R
Ladder Side Rail Endcap	F	A279	Black Rubber	Z279

## **TERMS & CONDITIONS**

---

- › All products sold through Vantech USA Inc. should only be performed by licensed professionals experienced in installation and proper operations of the products. It is the responsibility of the installer to determine the suitability of the component for that application. It is both the buyer and installer's responsibility to know the weight capacity and limitations of the vehicle before installing. Check your local and state law regarding legal height, width, length, and weight restrictions prior to install or purchase.