

# Warehouse Use Only

---

Part #	QUANTITY
D101	1
P031-8	1
P131/P132B	2
A416B	4
P013B	4
A286-65B	2
G313	4
Z286	4
A20	4

Part #:	P3001B
Dimensions:	8" X 8" X 66" (Telescopic)
Weight:	???

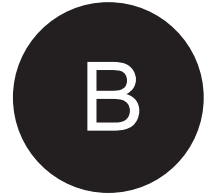

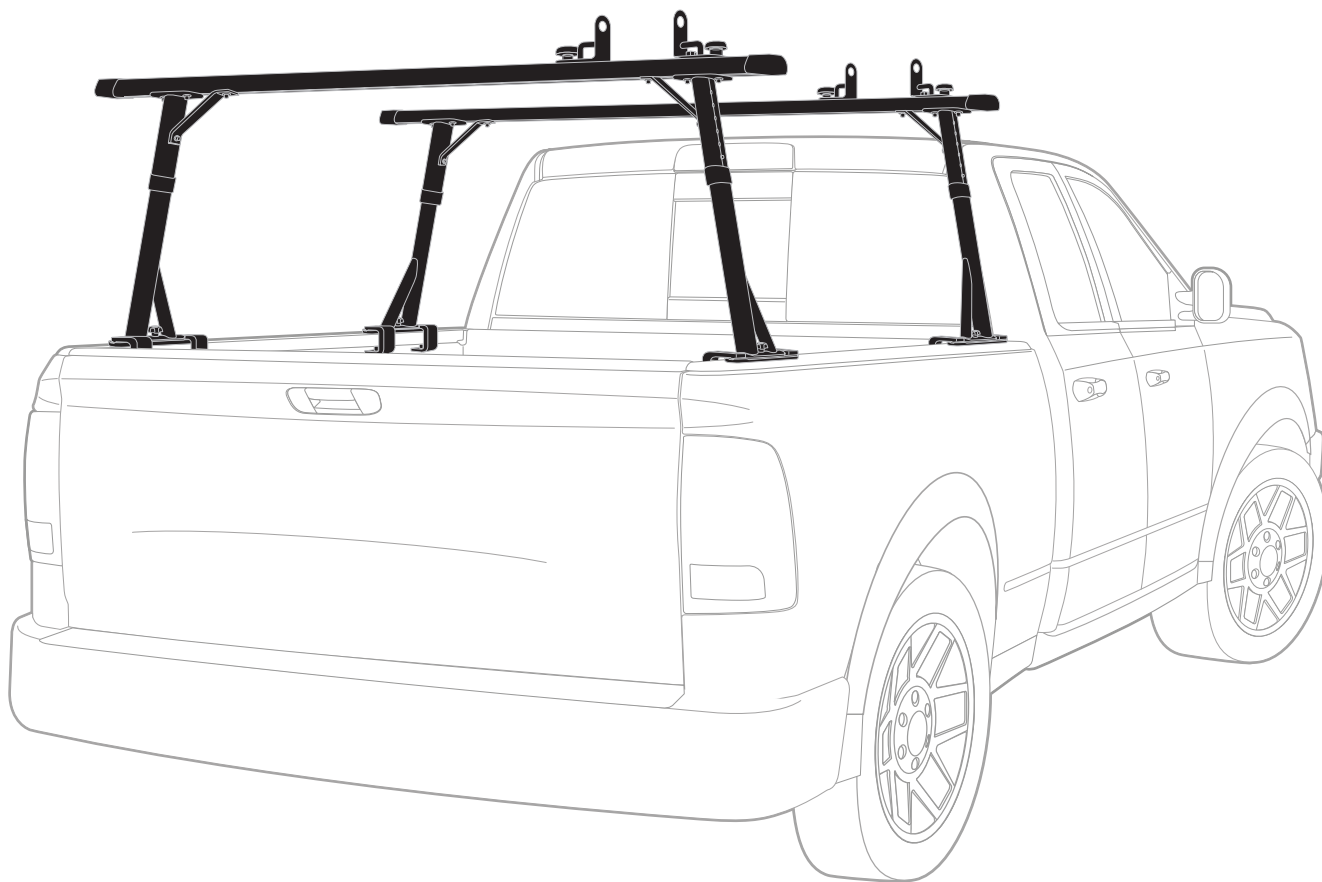

## PRODUCT INFO

---

Part #: P3001B  
System: P3000  
Material: Aluminum  
Fitment: Pickup (Clamp-On)  
Color: Black

## REQUIRED TOOLS

---

9/16" Wrench

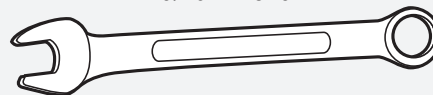



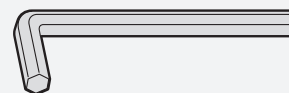



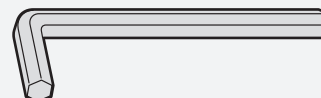



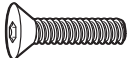



3/16" Allen Key Wrench

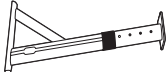
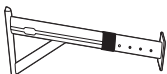
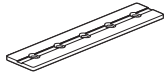

7/32" Allen Key Wrench



PART #	DESCRIPTION	QTY	ITEM ITEM NOT DRAWN TO SCALE
S101	3/8" SINGLE SLIDER (LENGTH 1")	4	
S103	3/8" DOUBLE SLIDER 3"	4	
B167	5/16" X 1 1/2" COUNTERSUNK BOLT	4	
B177	3/8" X 3/4" COUNTERSUNK BOLT	8	
N003	3/8" NUT	16	
N015	5/16" KNOB SMALL	4	
W008	5/16" X 3/4" WASHER	4	
W013	3/8" X 3/4" WASHER	16	
W023	3/8" LOCK WASHER	16	
P031	P3000 CLAMP	8	
P131	ADJUSTABLE" UPRIGHT L	2	
P132	ADJUSTABLE" UPRIGHT R	2	
P012	BASE PLATE	4	
P013	ANGLED BRACE	4	
A286-65	3" X 1.5" X 65" CROSS BAR	2	
G313	2" X 13" GASKET	4	
Z286	A286 ENDCAPS	4	
A20	ADJUSTABLE GUIDE	4	