



# Warehouse Use Only

---

Part #	QUANTITY
D252	1
D260	1
L100S	1 Box
A279-68S	2
L201S	6

Part #:	L003S
Dimensions:	4" X 4" X 69" (Telescopic)
Weight:	???

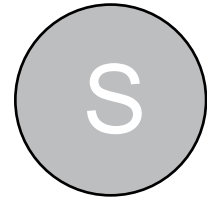

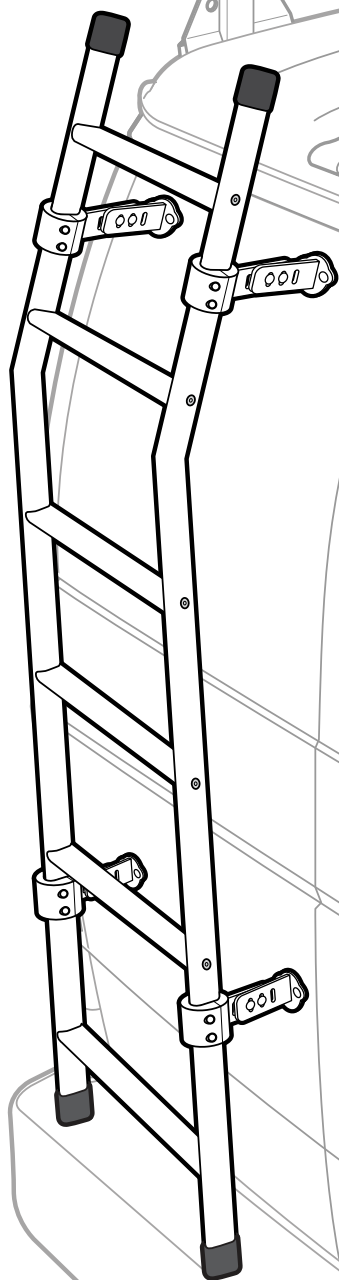

## PRODUCT INFO

Part #: L003S  
System: Rear Access Ladder  
Material: Aluminum  
Fitment: Low Roof Vehicles  
Color: Silver

## REQUIRED TOOLS

Marker



Power Tool with 5/16" Drill bit

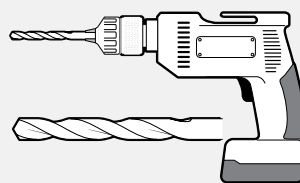



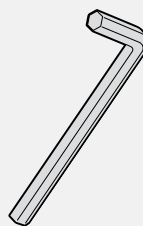



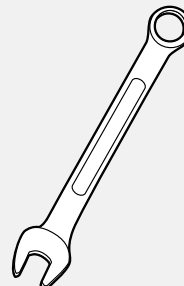

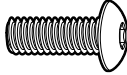

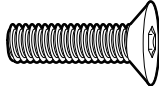



3/16" Allen Key Wrench

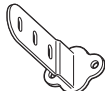

1/2" Wrench



PART #	DESCRIPTION	QTY	ITEM ITEM NOT DRAWN TO SCALE
SS-B117	5/16" X 1" BUTTON HEAD ALLEN BOLT	8	
SS-B119	5/16" X 1 1/2" BUTTON HEAD ALLEN BOLT	8	
SS-B167	5/16" X 1 1/2" ALLEN COUNTERSUNK BOLT	12	
SS-B251	1/4" X 1/2" CYLINDER HEAD ALLEN BOLT	16	
SS-N002	5/16" NUT	16	
SS-W008	5/16" X 3/4" WASHER	32	
SS-W022	5/16" LOCK WASHER	16	
Z279	ENDCAP	4	
GL001	GASKET	4	
M02	INTERIOR PLATE (2.25" BOLT TO BOLT)	4	
L001	LADDER ADAPTOR 1	4	
L002	LADDER ADAPTOR 2	4	
L003	LADDER ADAPTOR 3	4	
A279-68	LADDER SIDE RAIL 68" (ANGLED)	2	
L201	LADDER RUNG	6	

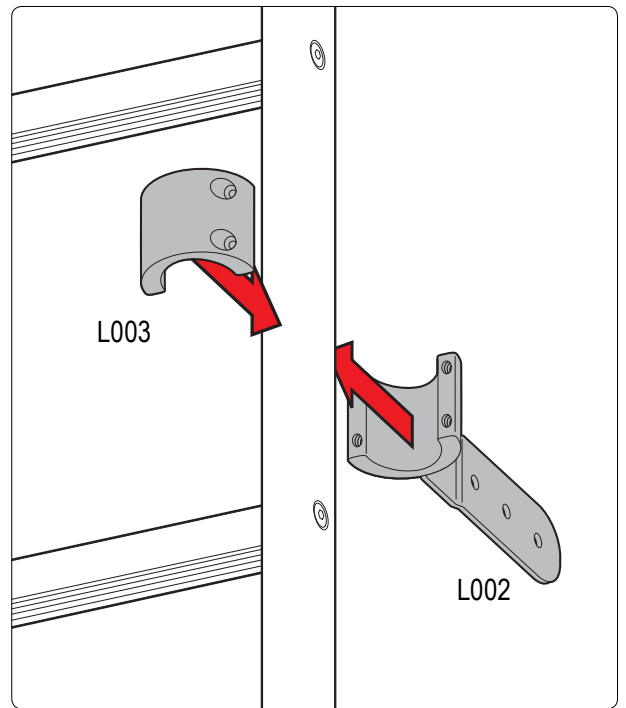
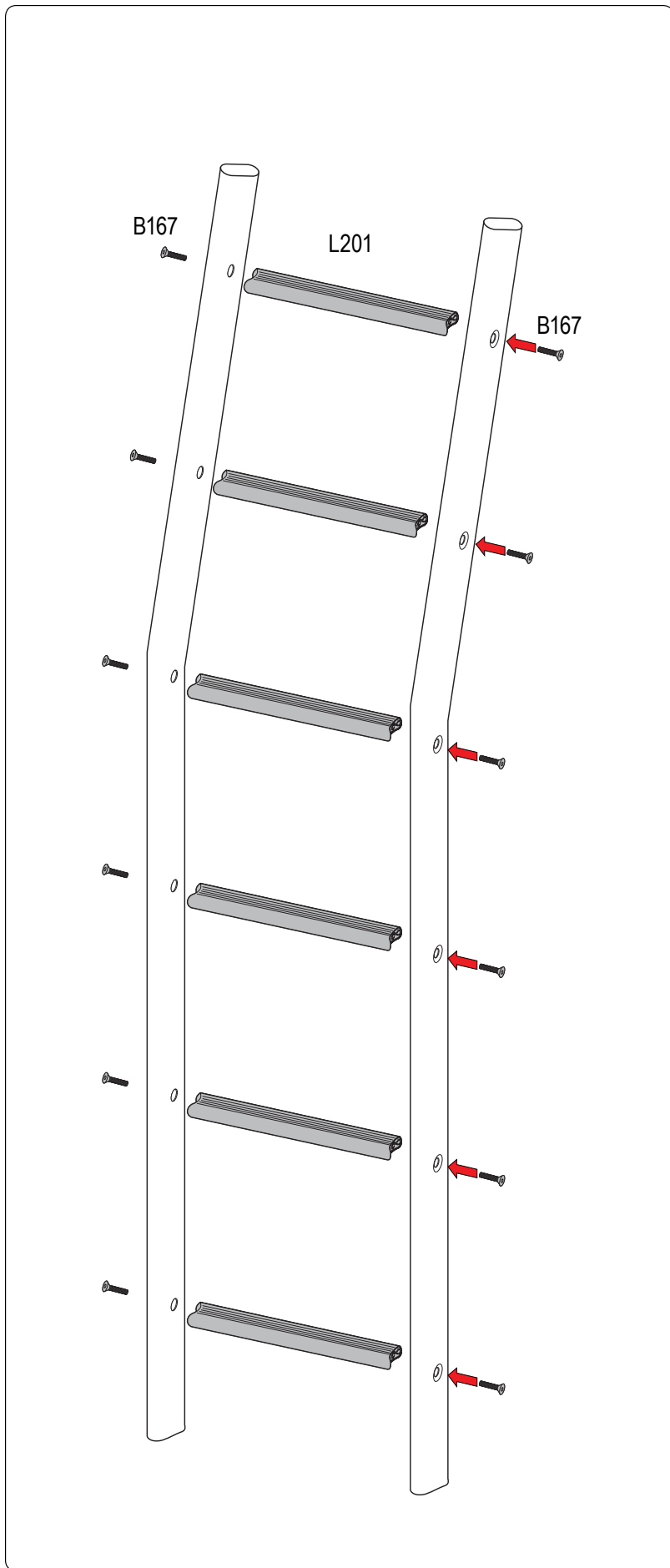

Repeat all steps 4 times for the 4 ladder mounts.

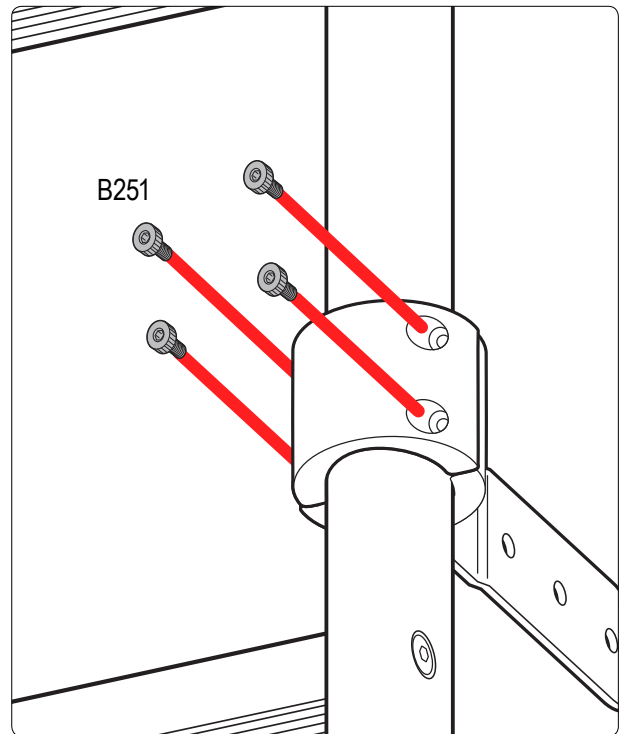

Do not completely tighten bolts so adjustments can be made later on.

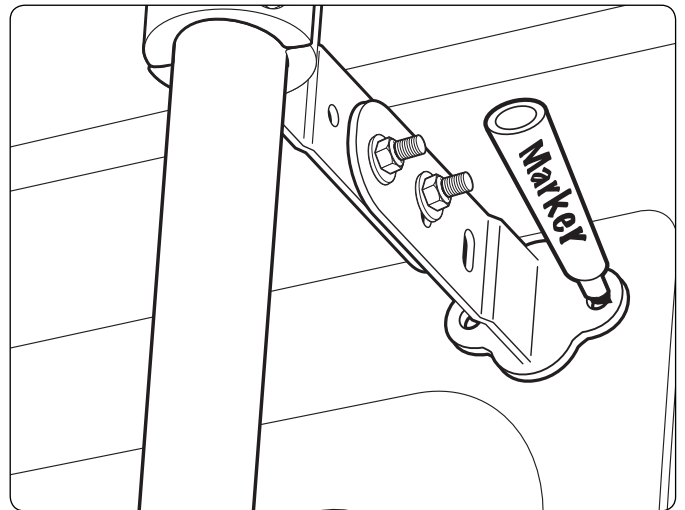
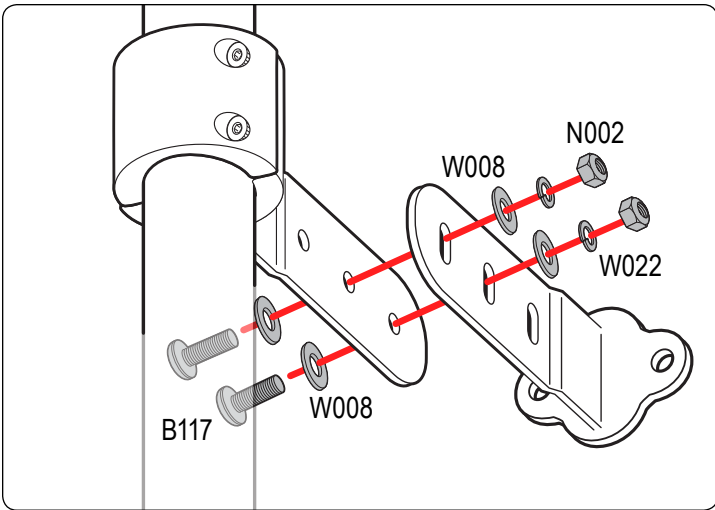

Depending on your curve of your vehicle you can use hole combinations to create different angles. Have 2 bolts per mount

Position the ladder mounts onto your vehicle's door.

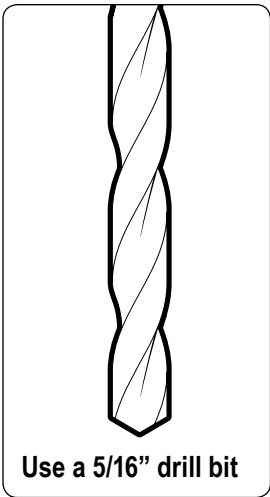

Use a 5/16" drill bit

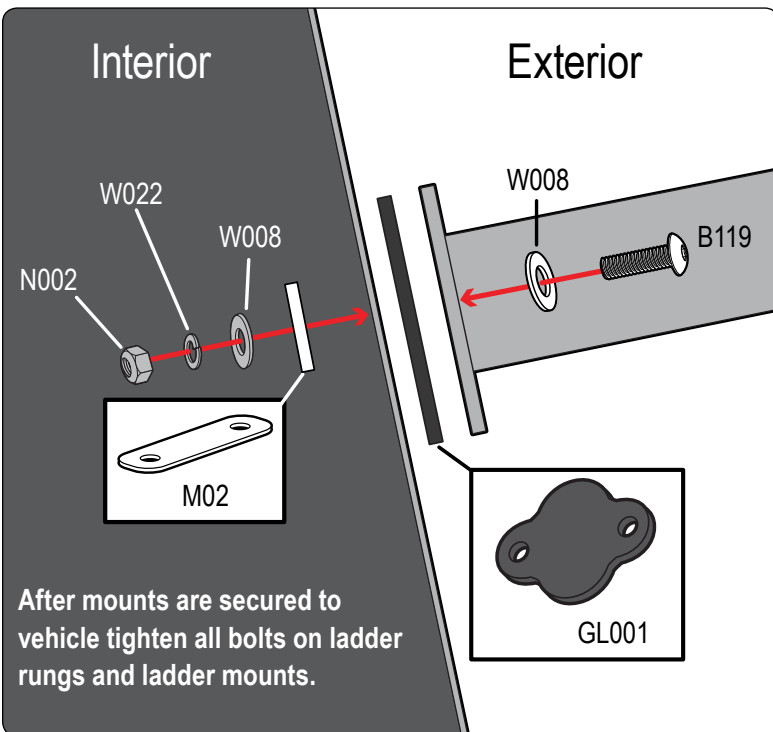
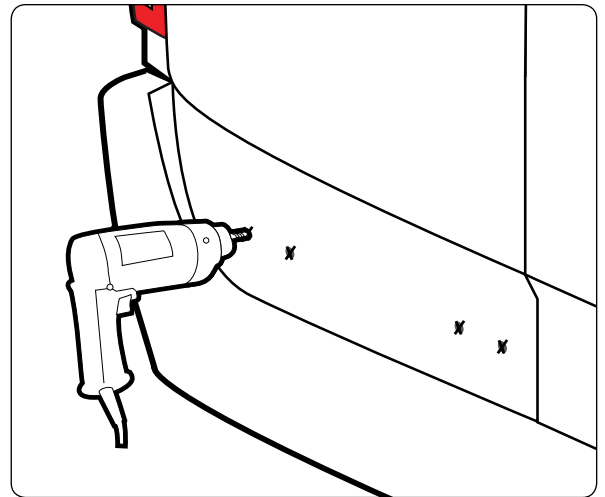
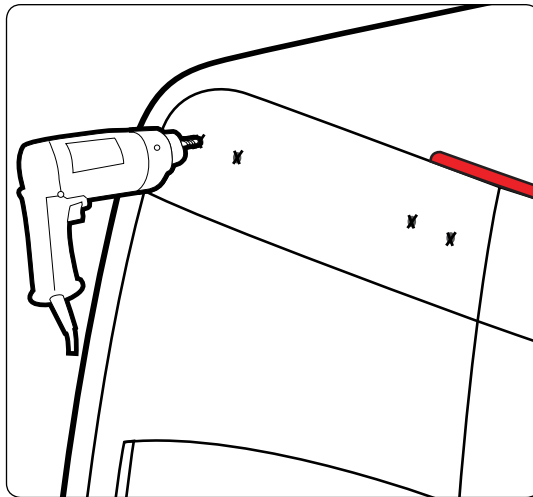

After mounts are secured to vehicle tighten all bolts on ladder rungs and ladder mounts.

