



# Warehouse Use Only

---

Part #	QUANTITY
D066	1
D116	1
D114	1
G203	6
M11-2B	2
M11B	4
A285-50S	3
BG550	3
A04	6
A11	2
A15	2
A69	2

Part #:	J2203S
Dimensions:	6" X 6" X 51" (Telescopic)
Weight:	???

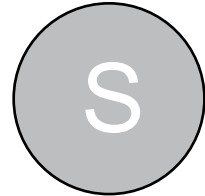

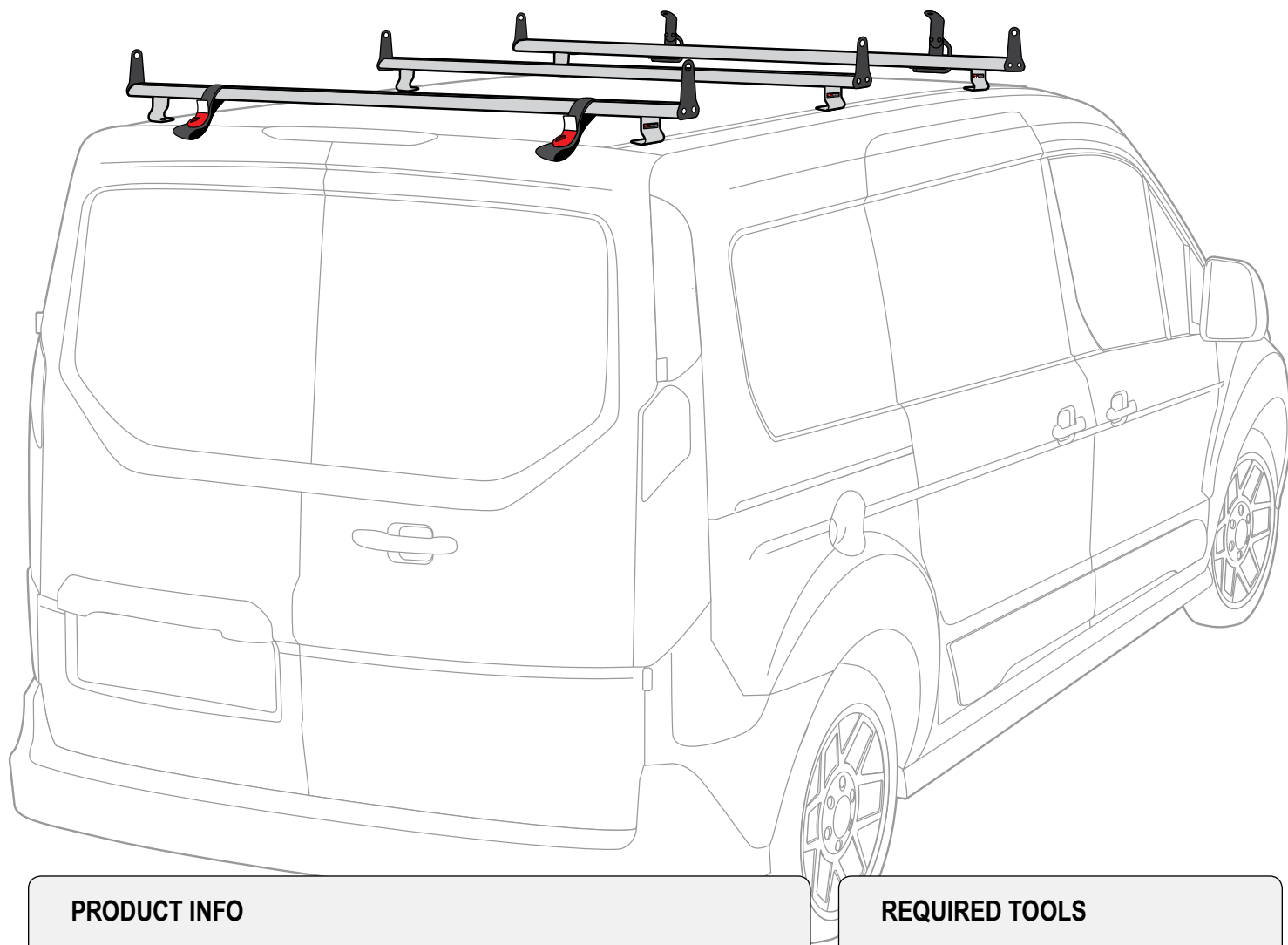

### PRODUCT INFO

---

Part #: J2203S  
System: J2000  
Material: Aluminum  
Fitment: Ford Transit Connect 2014-On  
Color: Silver

### REQUIRED TOOLS





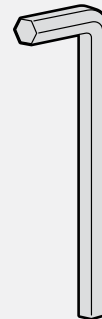



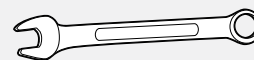

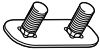



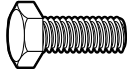
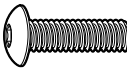

---

3/16" Allen Key Wrench



1/2" Wrench

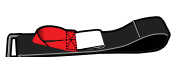

PART #	DESCRIPTION	QTY	ITEM ITEM NOT DRAWN TO SCALE
S052	DOUBLE SLIDER 2" BOLT TO BOLT	6	
S062	DOUBLE SLIDER 1 3/8" BOLT TO BOLT	2	
W001	1/4" X 3/4" WASHER	12	
W008	5/16" X 3/4" WASHER	36	
W022	5/16" LOCK WASHER	6	
B065	5/16" X 1" HEX BOLT	4	
B103	1/4" X 1" BUTTON HEAD ALLEN BOLT	12	
B068	5/16" X 1 3/4" HEX BOLT	6	
N002	5/16" NUT	6	
N005	5/16" NYLON NUT	20	
M11-2	MOUNTING BASE (LOW)	2	
M11	MOUNTING BASE (STANDARD)	4	
A285-50	2.25" X 1" X 50" CROSS BAR	3	
G203	RUBBER SEAT 2.75"	6	
BG550	RUBBER BAR GUARD 50"	3	
A04	SIDE SUPPORT	6	
A11	LADDER BASE	2	
A15	STOPPER	2	
A69	EZ-VELCRO STRAP	2	

### EZ-Velcro Strap

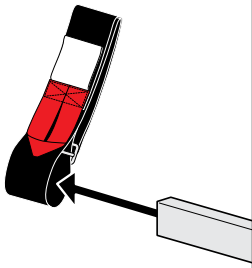

### Directions

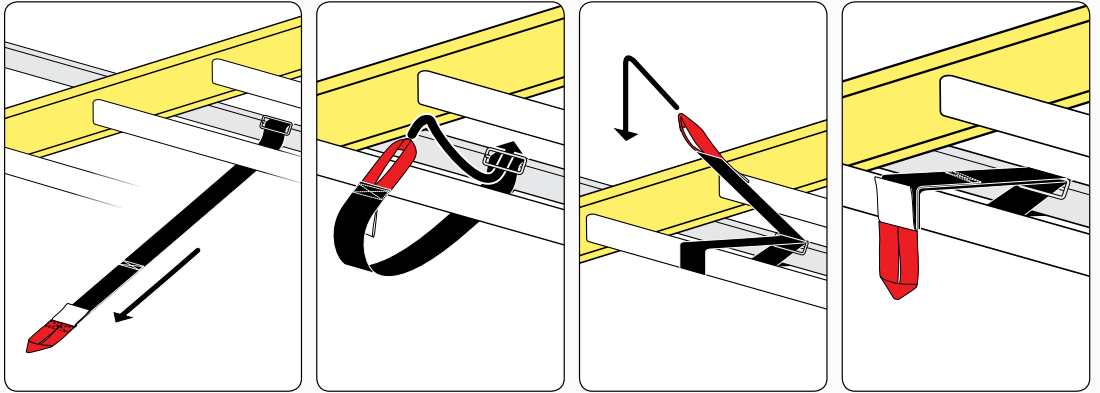

### RUBBER BAR GUARDS

- Press the rubber bar guard into the channels of cross bars

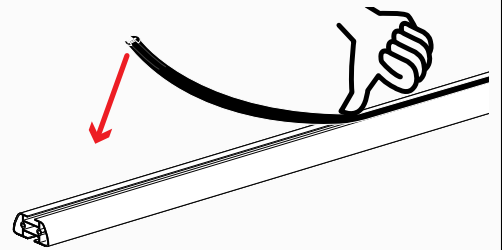
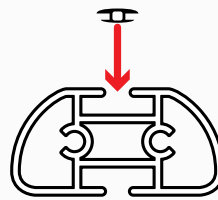

### SYSTEM PLACEMENT MUST BE PLACED IN THIS ORDER

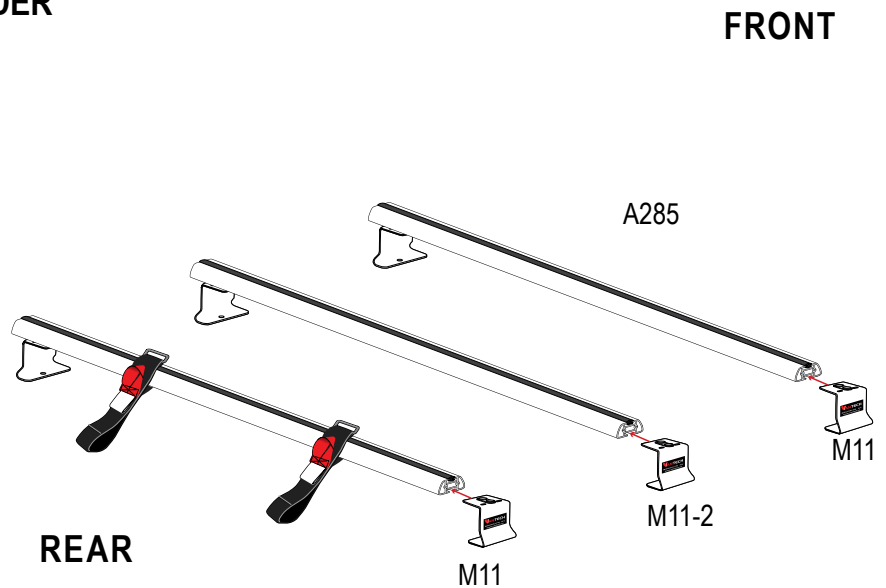
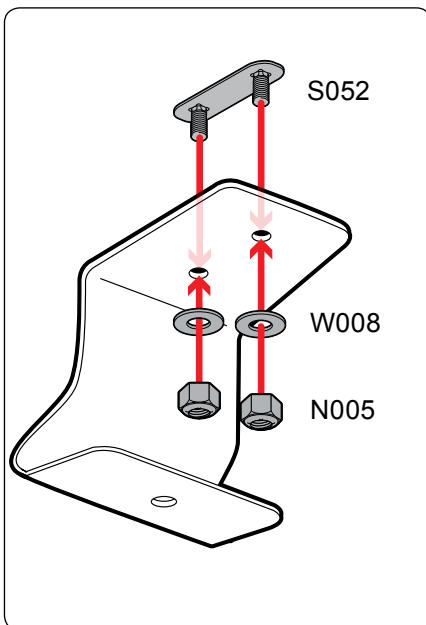

Do not tighten hardware

