



Warehouse Use Only

Part #	QUANTITY
D069	1
D115	1
D113	1
G004	4
M13B	4
A285-60B	2
BG560	2
A04	4
A11	1
A15	1
A69	1

Part #:	J2005B
Dimensions:	6" X 6" X 61" (Telescopic)
Weight:	???



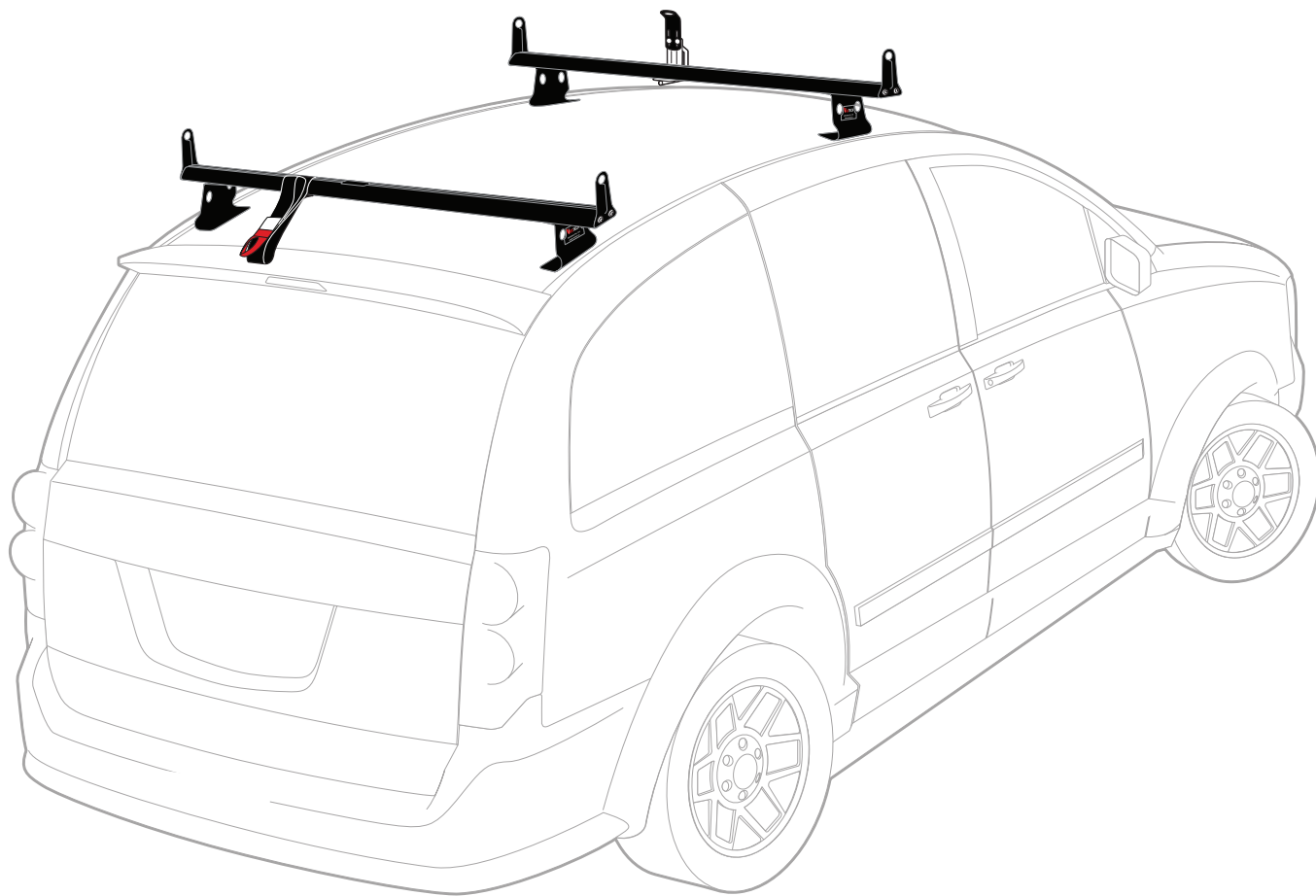

PRODUCT INFO

Part #: J2005B
System: J2000
Material: Aluminum
Fitment: Universal (Drilling Required)
Color: Black

REQUIRED TOOLS

Power Tool With 5/16" Drill Bit

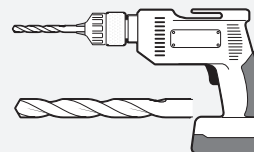

1/2" Wrench

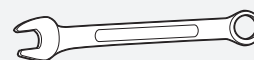













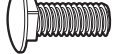
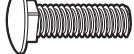



3/16" Allen Key Wrench



Marker



PART #	DESCRIPTION	QTY	ITEM ITEM NOT DRAWN TO SCALE
S052	DOUBLE SLIDER 2" BOLT TO BOLT	4	
S062	DOUBLE SLIDER 1 3/8" BOLT TO BOLT	1	
W001	1/4" X 1/2" WASHER	8	
W008	5/16" X 3/4" WASHER	20	
B015	5/16" X 1" CARRIAGE BOLT	2	
B016	5/16" X 1 1/4" CARRIAGE BOLT	8	
B103	1/4" X 1" BUTTON HEAD ALLEN BOLT	8	
N005	5/16" NYLON NUT	20	
M13	MOUNTING BASE	4	
M07	INTERIOR PLATE	4	
A285-60	2.25" X 1" X 60" CROSS BAR	2	
G004	POLYFOAM GASKET 1.5" X 4"	4	
BG560	RUBBER BAR GUARD 60"	2	
A04	SIDE SUPPORT	4	
A11	LADDER BASE	1	
A15	STOPPER	1	
A69	EZ-VELCRO STRAP	1	

RUBBER BAR GUARDS

- Press the rubber bar guard into the channels of cross bars

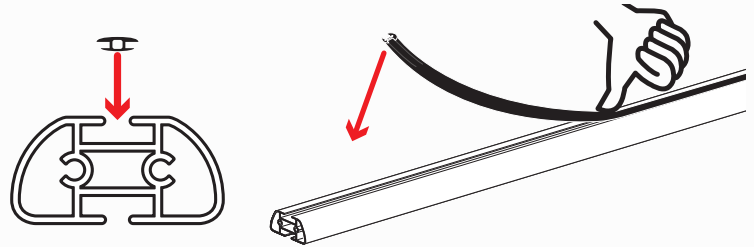

EZ-Velcro Strap

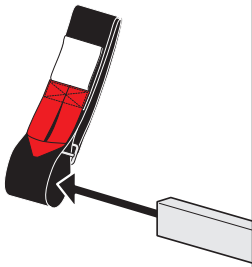

Directions

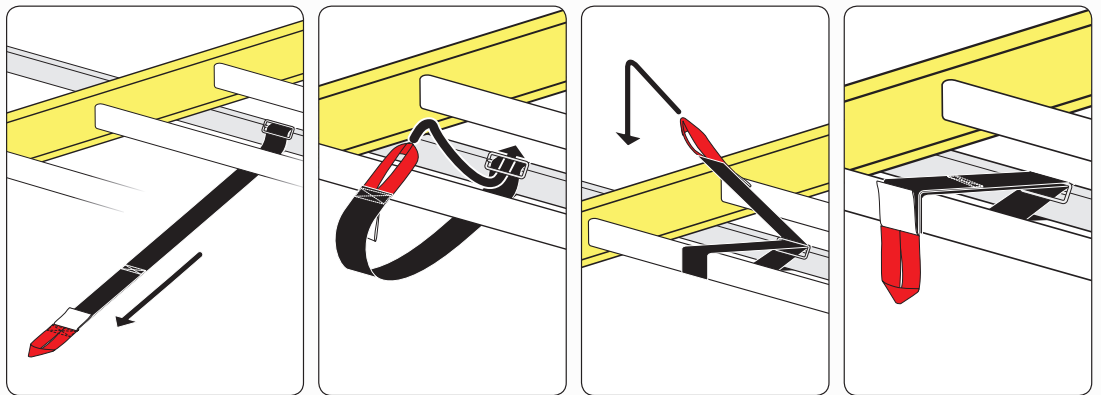

SYSTEM PLACEMENT MUST BE PLACED IN THIS ORDER

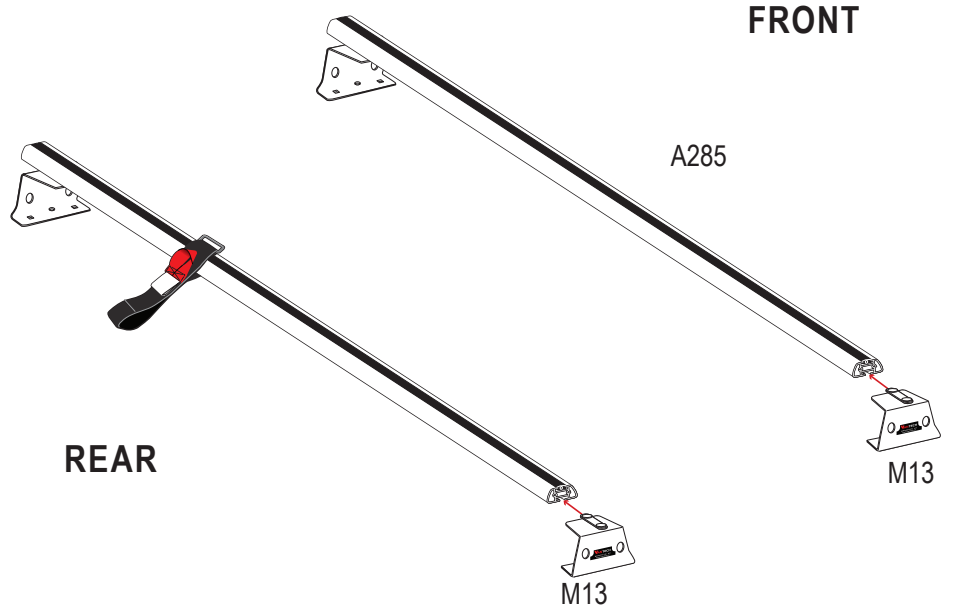
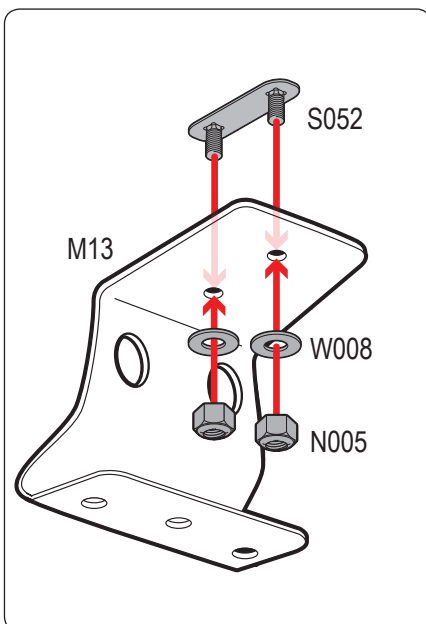

Do not tighten hardware

