

Warehouse Use Only

Part #	QUANTITY
D056	1
D116	1
G206	6
M08W	6
A286-65W	3
BG565	3
Z286	6

Part #:	H3703W
Dimensions:	6" X 6" X 66" (Telescopic)
Weight:	???

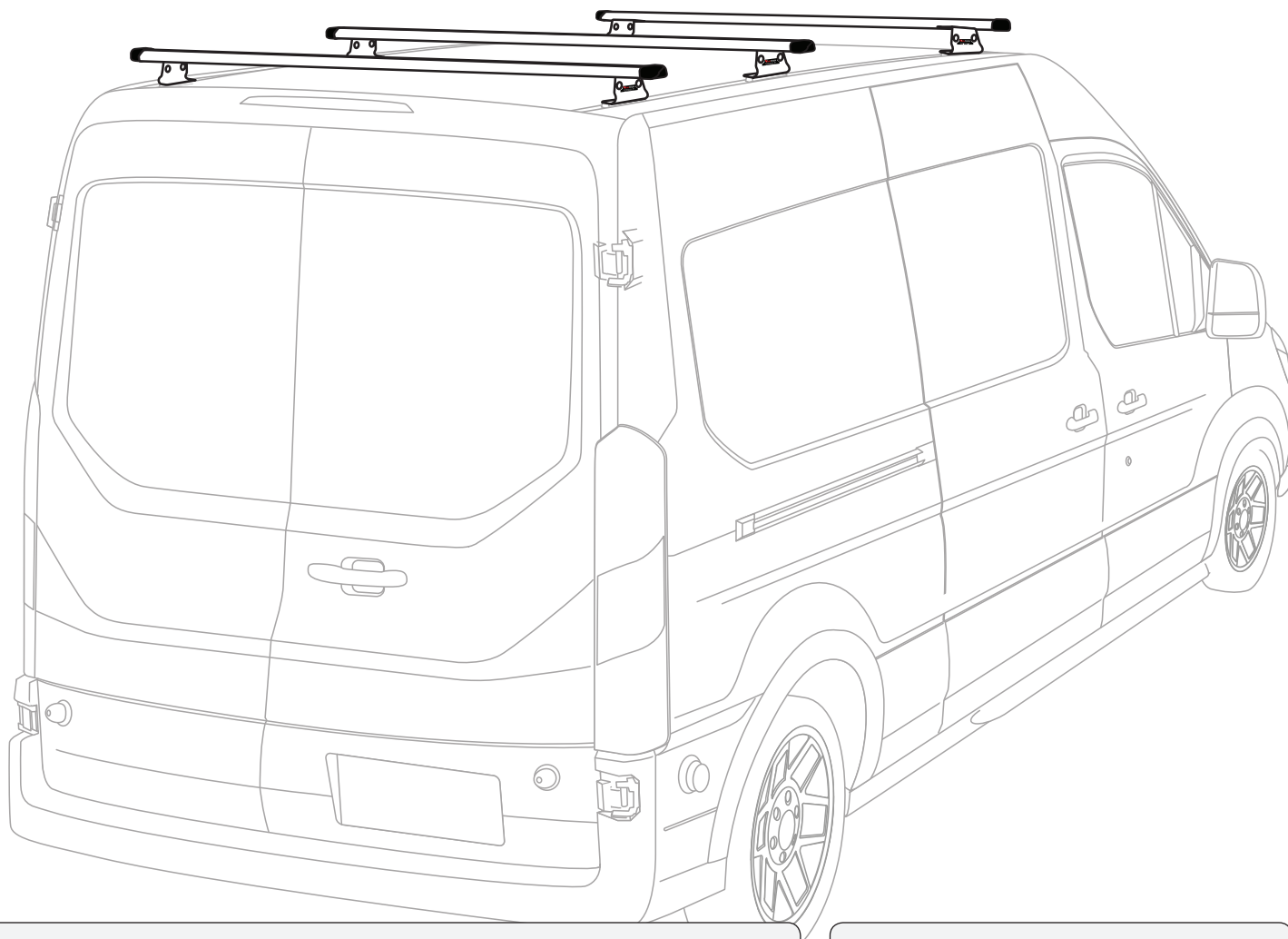









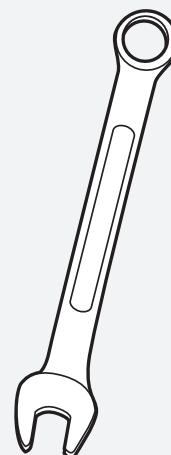

FOR WAREHOUSE USE

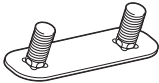
Part #: H3703W
System: H3 Series
Material: Aluminum
Fitment: Ford Transit Cargo Van 2015-On
Color: White

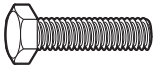
REQUIRED TOOLS

1/2" Wrench



PART #	DESCRIPTION	QTY	ITEM ITEM NOT DRAWN TO SCALE
S052	DOUBLE SLIDER 2" BOLT TO BOLT	6	
W008	5/16" X 3/4" WASHER	18	
W022	5/16" LOCK WASHER	6	
B246	M8-35 HEX BOLT	6	
N005	5/16" NYLON NUT	12	
G206	RUBBER SEAT 6"	6	
M08	MOUNTING BASE	6	
A286-65	3" X 1.5" X 65" CROSS BAR	3	
BG565	RUBBER BAR GUARD 65"	3	
Z286	ENDCAP	6	

RUBBER BAR GUARDS

- Press the rubber bar guard into the channels of cross bars

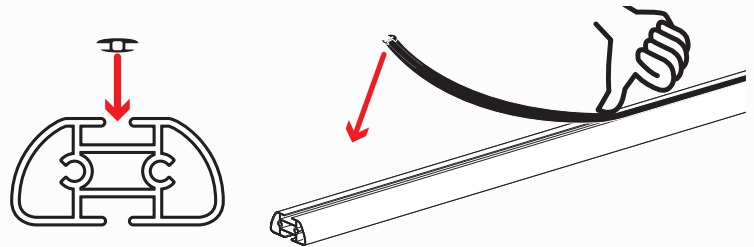

FRONT

A286

M08

M08

REAR

M08

Do not tighten hardware

