

Warehouse Use Only

Part #	QUANTITY
D062	1
D118	1
H11W	6
H16W	2
H17W	4
A286-72W	3
BG572	3
Z286	6
BG908	6

Part #:	H3230W
Dimensions:	8" X 8" X 73" (Telescopic)
Weight:	???

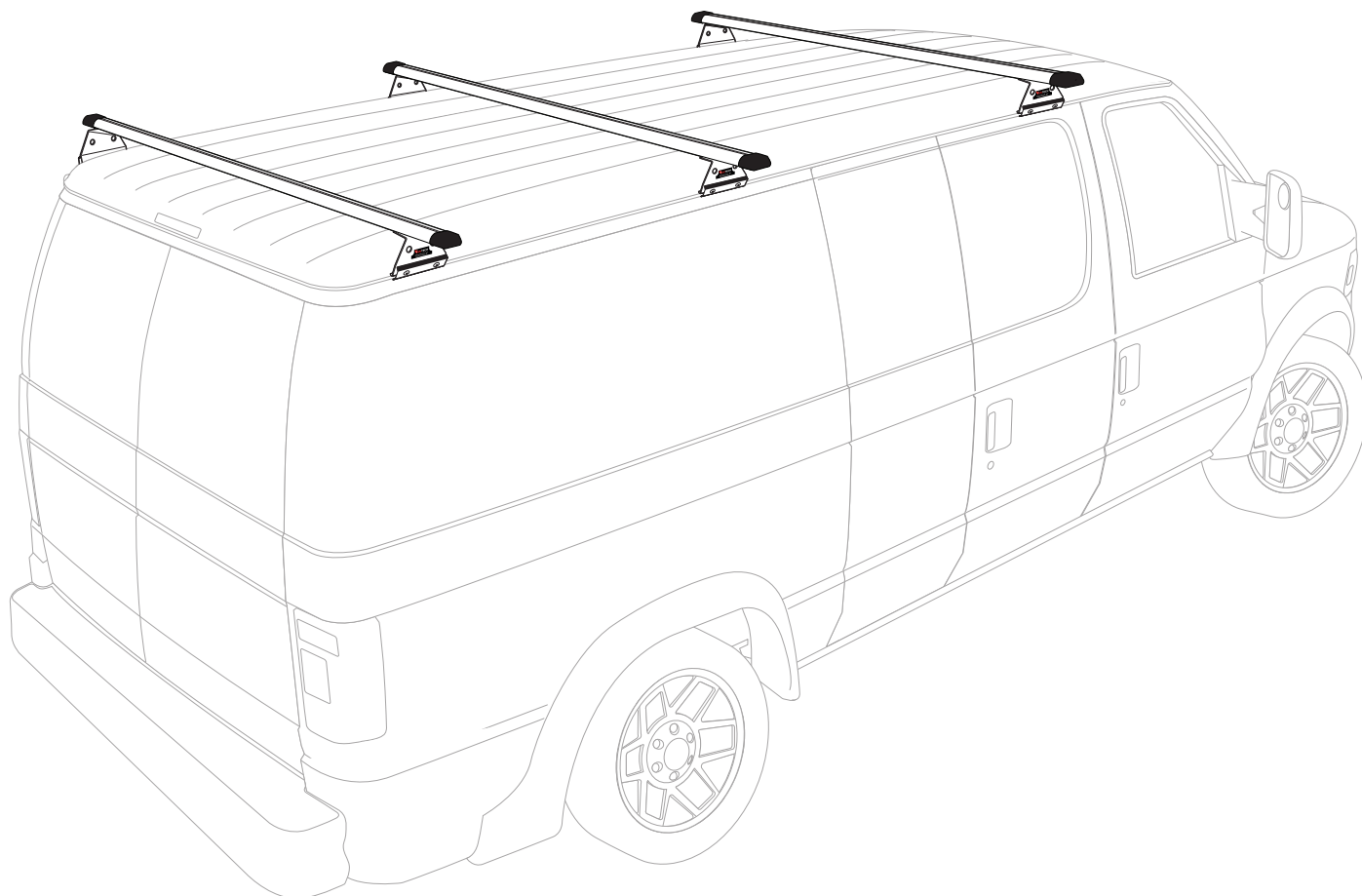



PRODUCT INFO

Part #: H3230W
System: H3 Series
Material: Aluminum
Fitment: Ford Econoline 1992-13
Color: White





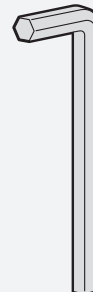



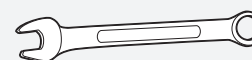

REQUIRED TOOLS

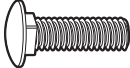
3/16" Allen Key Wrench



1/2" Wrench



PART #	DESCRIPTION	QTY	ITEM ITEM NOT DRAWN TO SCALE
S053	DOUBLE SLIDER 3" BOLT TO BOLT	6	
W008	5/16" X 3/4" WASHER	24	
B016	5/16" X 1 1/4" CARRIAGE BOLT	12	
N005	5/16" NYLON NUT	24	
H11	DRIP RAIL CLAMP	6	
H16	MOUNTING BASE (LOW)	2	
H17	MOUNTING BASE (STANDARD)	4	
A286-72	3" X 1.5" X 72" CROSS BAR	3	
BG572	RUBBER BAR GUARD 72"	3	
Z286	ENDCAP	6	
BG908	RUBBER SEAT	6	

RUBBER SEATS FOR UPRIGHT MOUNTS

- Slide the Rubber Seats onto the bottom of the Upright Mounts.
- These prevent metal on metal contact for vehicles without a protective layer on their drip rail.

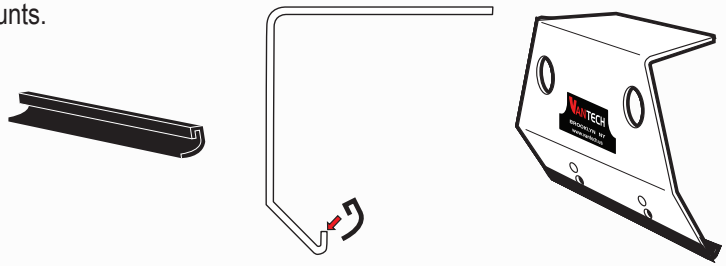

RUBBER BAR GUARDS

- Press the rubber bar guard into the channels of cross bars

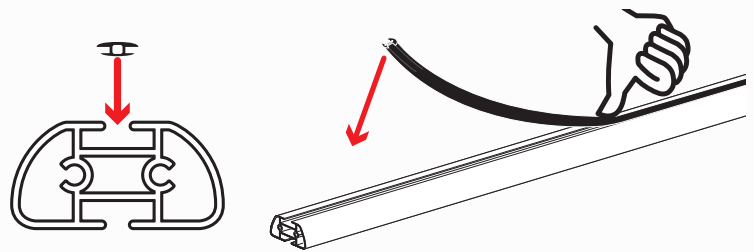

SYSTEM PLACEMENT MUST BE PLACED IN THIS ORDER

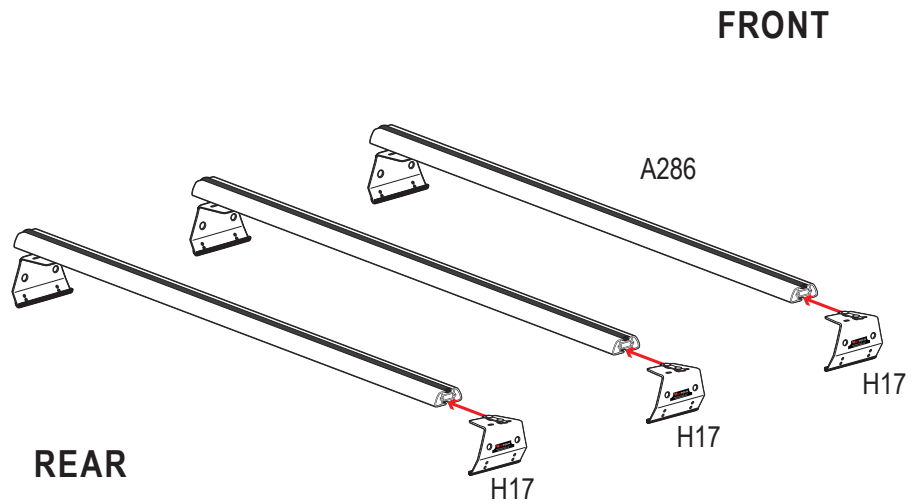
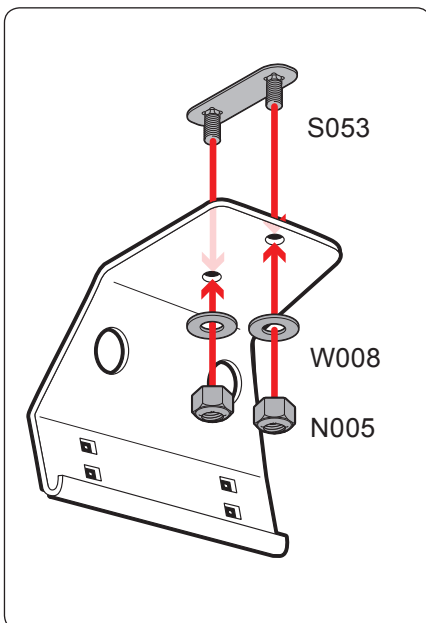

Do not tighten hardware

