

# Warehouse Use Only

---

Part #	QUANTITY
D062	1
D110	1
H11B	6
H08B	2
H09B	4
A613-62B	1
A613-63B	2
BG555	3
BG908	6
A02	2
A06	2
A69	2

Part #:	H3083B
Dimensions:	8" X 8" X 64" (Telescopic)
Weight:	???



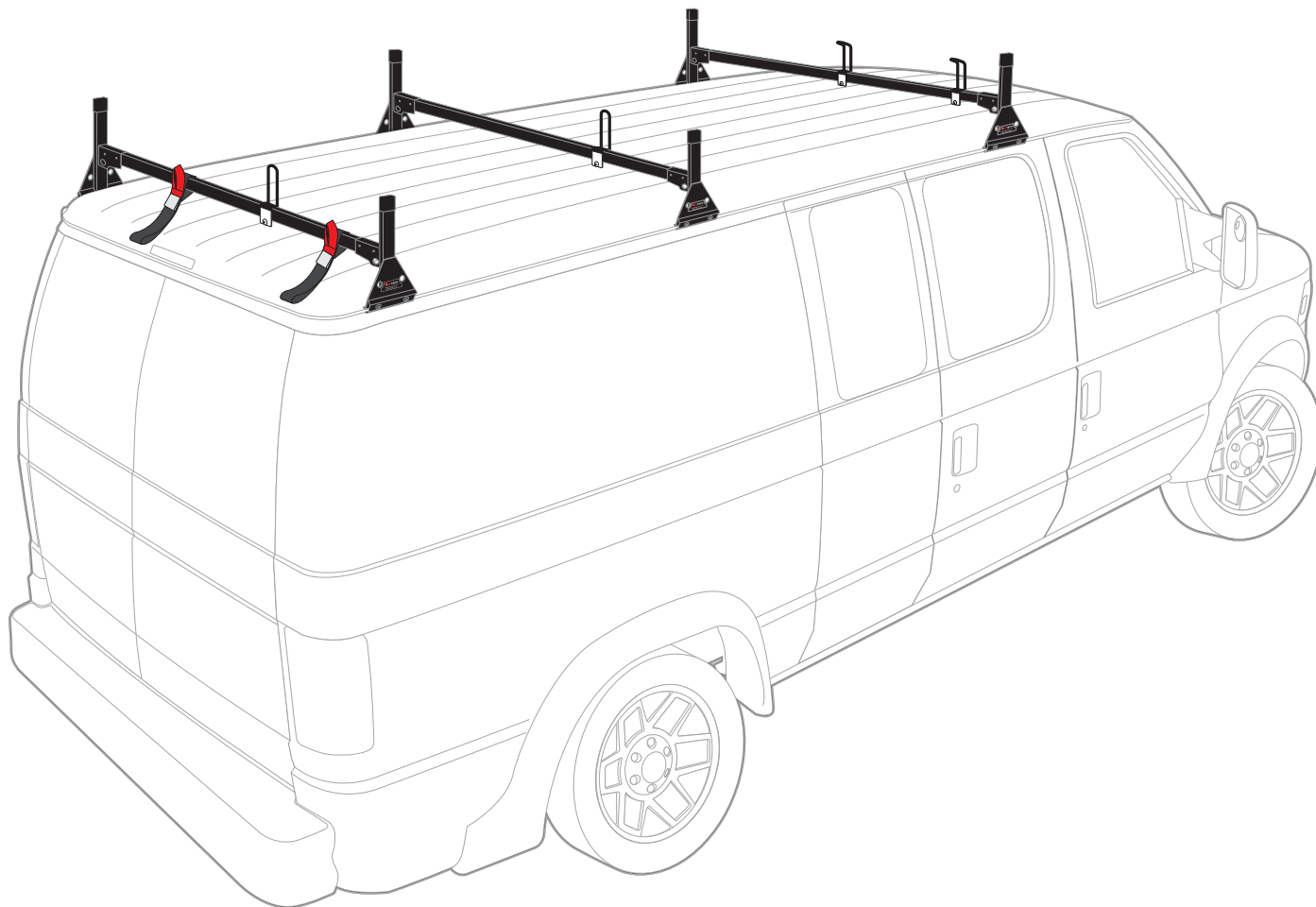

### PRODUCT INFO

---

Part #: H3083B  
System: H1 Series  
Material: Aluminum  
Fitment: Ford Econoline 1992-13  
Color: Black

### REQUIRED TOOLS





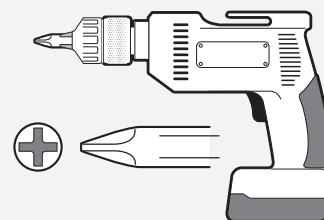





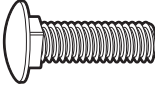
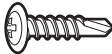

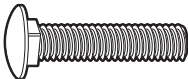
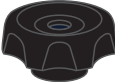
---

Power Tool With Phillips Head



1/2" Wrench



PART #	DESCRIPTION	QTY	ITEM ITEM NOT DRAWN TO SCALE
B016	5/16" X 1 1/4" CARRIAGE BOLT	12	
B201	TAP SCREW	12	
N005	5/16" NYLON NUT	12	
W008	5/16" X 3/4" WASHER	12	
B018	5/16" X 1 3/4" CARRIAGE BOLT	4	
N016	5/16" KNOB	4	
H08	H1 MOUNTING BASE (LOW)	2	
H09	H1 MOUNTING BASE (STANDARD)	4	
A613-62	2" X 1" X 62" CROSS BAR	1	
A613-63	2" X 1" X 63" CROSS BAR	2	
H11	2" X 8" DRIP RAIL CLAMP	6	
A02	LADDER GUIDE	2	
A06	LADDER STOPPER	2	
A69	EZ-VELCRO STRAP	2	
BG555	RUBBER BAR GUARD 55"	3	
BG908	RUBBER SEAT	6	

### EZ-Velcro Strap

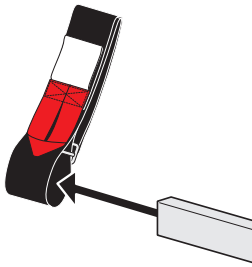

### Directions

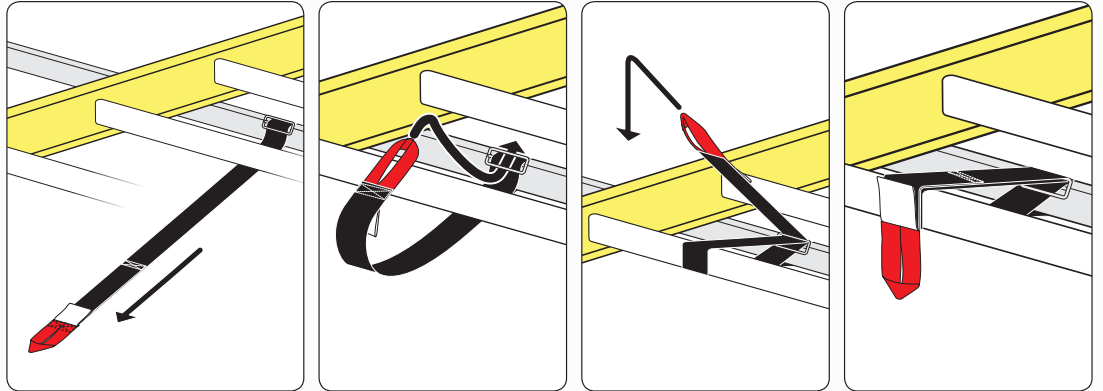

### RUBBER BAR GUARDS

- Press the rubber bar guard into the channels of cross bars
- Leave 4" on each end

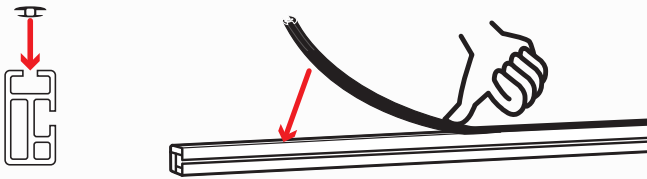

### RUBBER SEATS FOR UPRIGHT MOUNTS

- Slide the Rubber Seats onto the bottom of the Upright Mounts.
- These prevent metal on metal contact for vehicles without a protective layer on their drip rail.

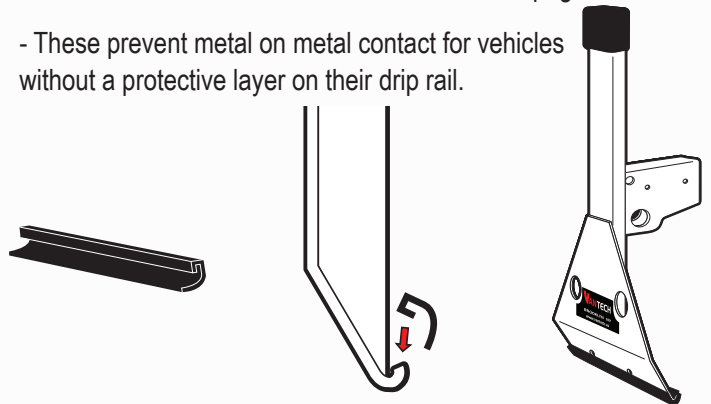

### SYSTEM PLACEMENT MUST BE PLACED IN THIS ORDER

