



Warehouse Use Only

Part #	QUANTITY
D062	1
D110	1
H11B	6
H08B	2
H09B	4
A613-56B	1
A613-57B	2
BG549	3
BG908	6
A02	2
A06	2
A69	2

Part #:	H3023B
Dimensions:	8" X 8" X 58" (Telescopic)
Weight:	???



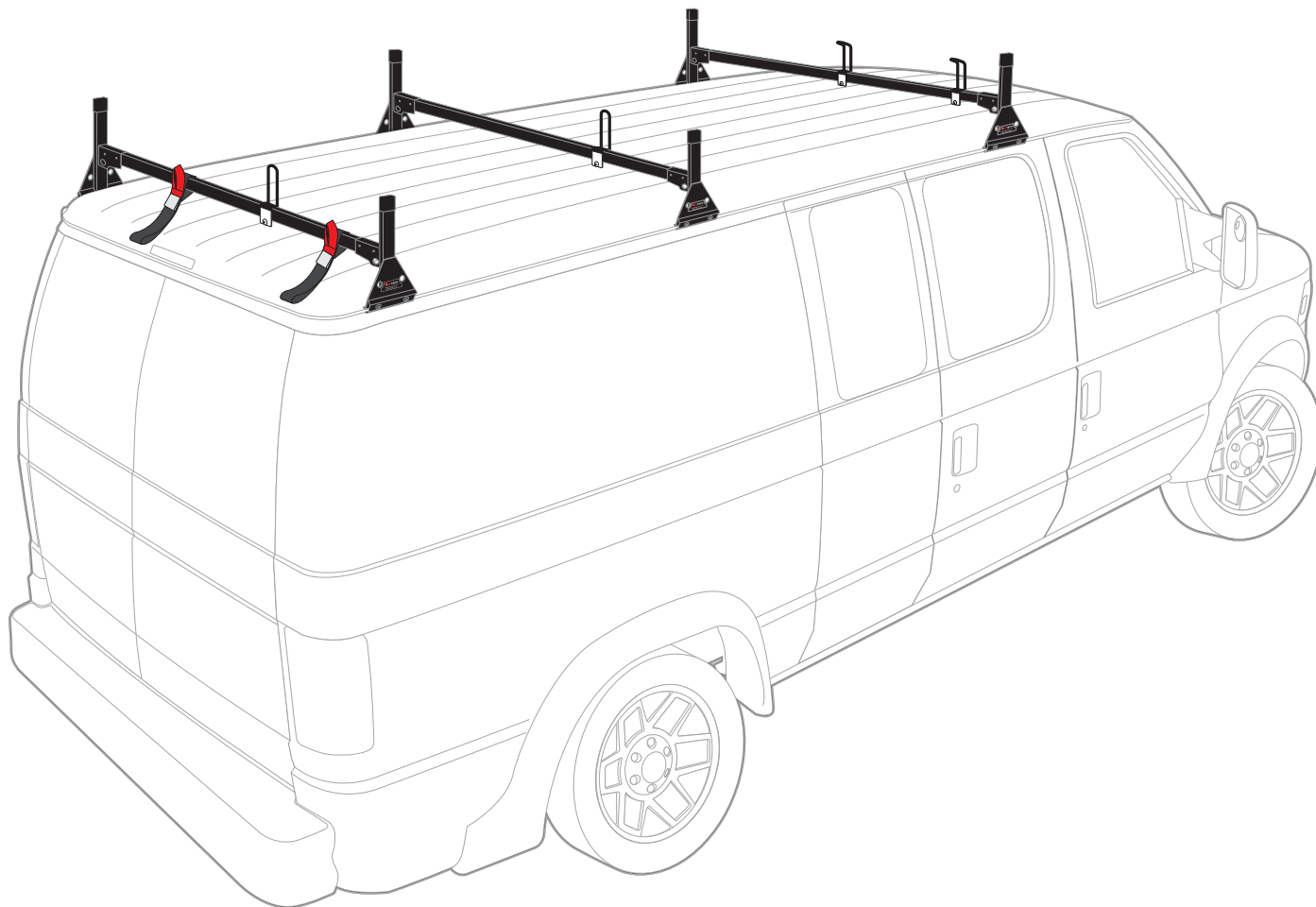

PRODUCT INFO

Part #: H3023B
System: H1 Series
Material: Aluminum
Fitment: Chevy Express 1996-14
Color: Black





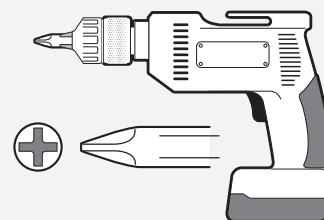





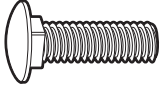
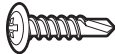

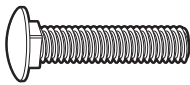
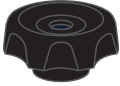
REQUIRED TOOLS

Power Tool With Phillips Head



1/2" Wrench



PART #	DESCRIPTION	QTY	ITEM ITEM NOT DRAWN TO SCALE
B016	5/16" X 1 1/4" CARRIAGE BOLT	12	
B201	TAP SCREW	12	
N005	5/16" NYLON NUT	12	
W008	5/16" X 3/4" WASHER	12	
B018	5/16" X 1 3/4" CARRIAGE BOLT	4	
N016	5/16" KNOB	4	
H08	H1 MOUNTING BASE (LOW)	2	
H09	H1 MOUNTING BASE (STANDARD)	4	
A613-56	2" X 1" X 56" CROSS BAR	1	
A613-57	2" X 1" X 57" CROSS BAR	2	
H11	2" X 8" DRIP RAIL CLAMP	6	
A02	LADDER GUIDE	2	
A06	LADDER STOPPER	2	
A69	EZ-VELCRO STRAP	2	
BG549	RUBBER BAR GUARD 49"	3	
BG908	RUBBER SEAT	6	

EZ-Velcro Strap

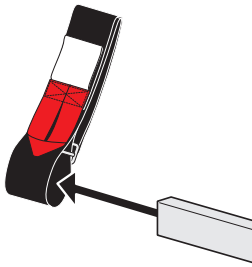

Directions

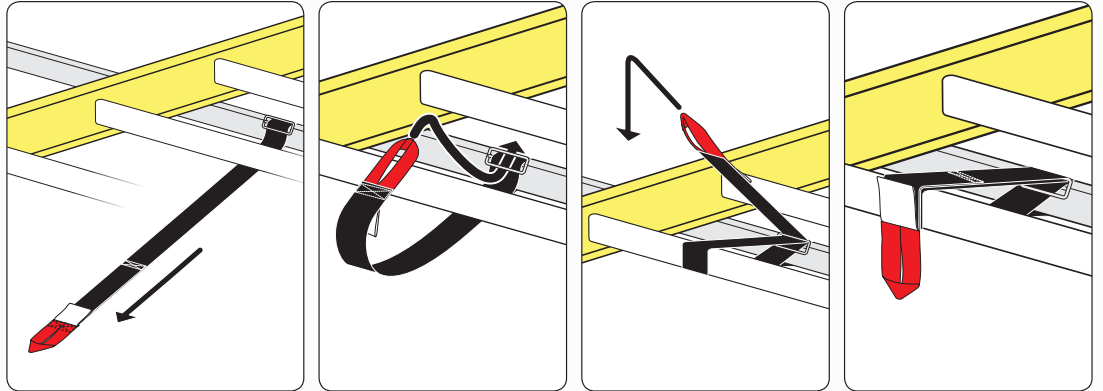

RUBBER BAR GUARDS

- Press the rubber bar guard into the channels of cross bars
- Leave 4" on each end

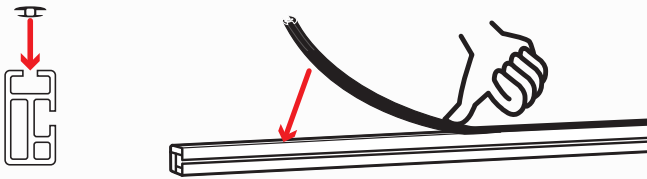

RUBBER SEATS FOR UPRIGHT MOUNTS

- Slide the Rubber Seats onto the bottom of the Upright Mounts.
- These prevent metal on metal contact for vehicles without a protective layer on their drip rail.

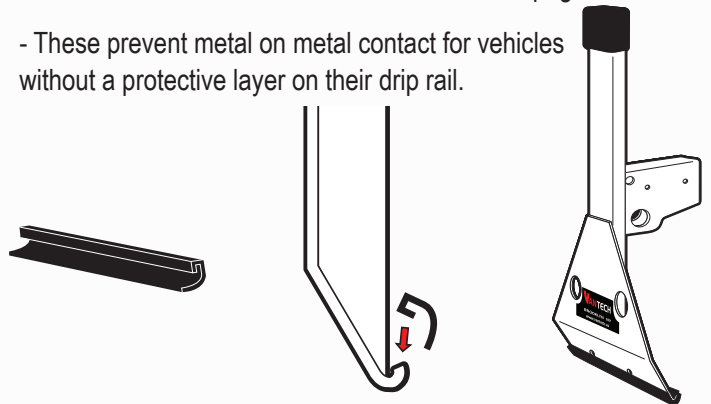

SYSTEM PLACEMENT MUST BE PLACED IN THIS ORDER

