



# Warehouse Use Only

---

Part #	QUANTITY
D061	1
D109	1
H11W	4
H09W	4
A613-56W	1
A613-57W	1
BG549	2
BG908	4
A02	1
A06	1
A69	1

Part #:	H3022W
Dimensions:	8" X 8" X 58" (Telescopic)
Weight:	???

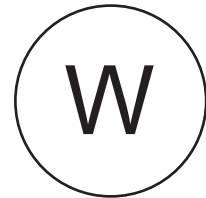

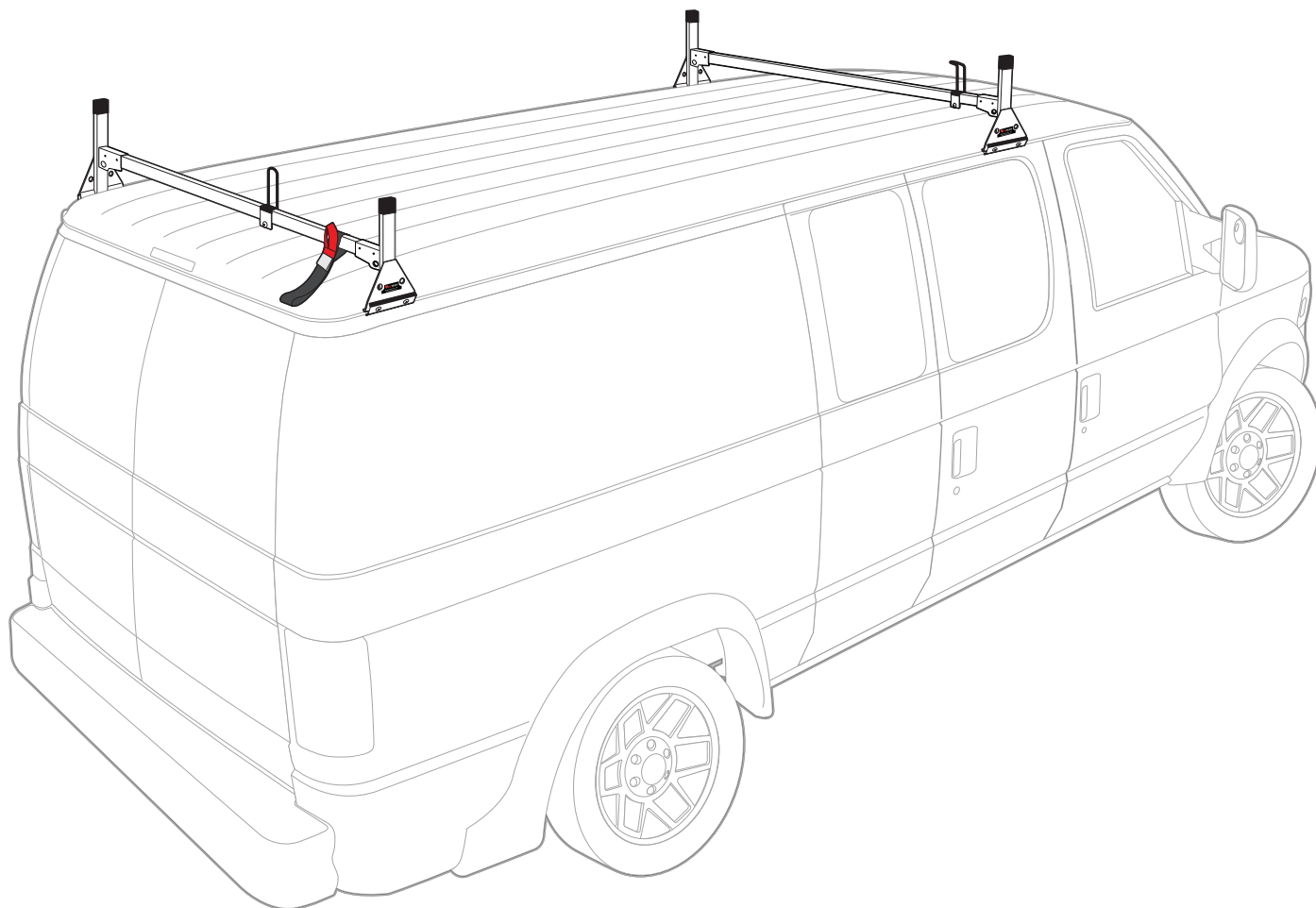

## PRODUCT INFO

---

Part #: H3022W  
System: H1 Series  
Material: Aluminum  
Fitment: Chevy Express 1996-14  
Color: White

## REQUIRED TOOLS





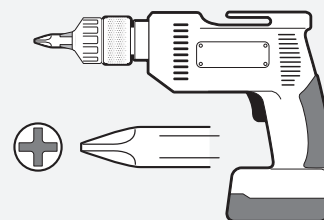





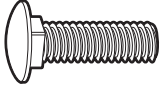
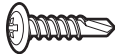

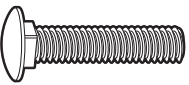
---

Power Tool With Phillips Head



1/2" Wrench



PART #	DESCRIPTION	QTY	ITEM ITEM NOT DRAWN TO SCALE
B016	5/16" X 1 1/4" CARRIAGE BOLT	8	
B201	TAP SCREW	8	
N005	5/16" NYLON NUT	8	
W008	5/16" X 3/4" WASHER	8	
B018	5/16" X 1 3/4" CARRIAGE BOLT	2	
N016	5/16" KNOB	2	
H09	H1 MOUNTING BASE (STANDARD)	4	
A613-56	2" X 1" X 56" CROSS BAR	1	
A613-57	2" X 1" X 57" CROSS BAR	1	
H11	2" X 8" DRIP RAIL CLAMP	4	
A02	LADDER GUIDE	1	
A06	LADDER STOPPER	1	
A69	EZ-VELCRO STRAP	1	
BG549	RUBBER BAR GUARD 49"	2	
BG908	RUBBER SEAT	4	

### EZ-Velcro Strap

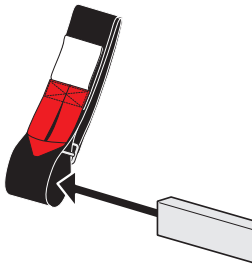

### Directions

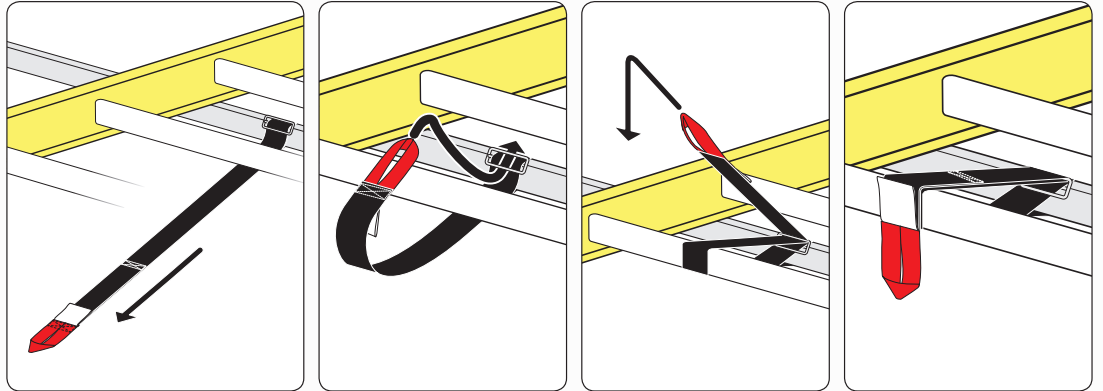

### RUBBER BAR GUARDS

- Press the rubber bar guard into the channels of cross bars
- Leave 4" on each end

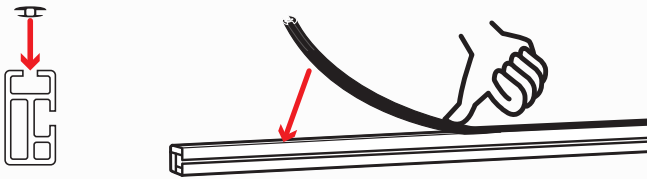

### RUBBER SEATS FOR UPRIGHT MOUNTS

- Slide the Rubber Seats onto the bottom of the Upright Mounts.
- These prevent metal on metal contact for vehicles without a protective layer on their drip rail.

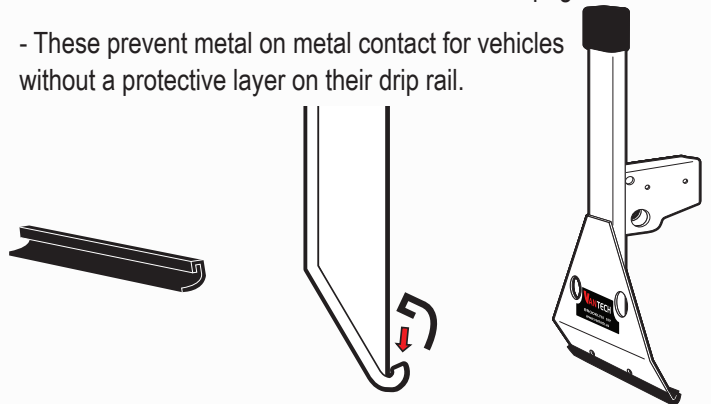

### SYSTEM PLACEMENT MUST BE PLACED IN THIS ORDER

