

Warehouse Use Only

Part #	QUANTITY
D010	1
D112	1
H33B	6
A500-50B	3
BG042	3
A02	2
A06	2
A69	2

Part #:	H2668B
Dimensions:	8" X 8" X 51" (Telescopic)
Weight:	???

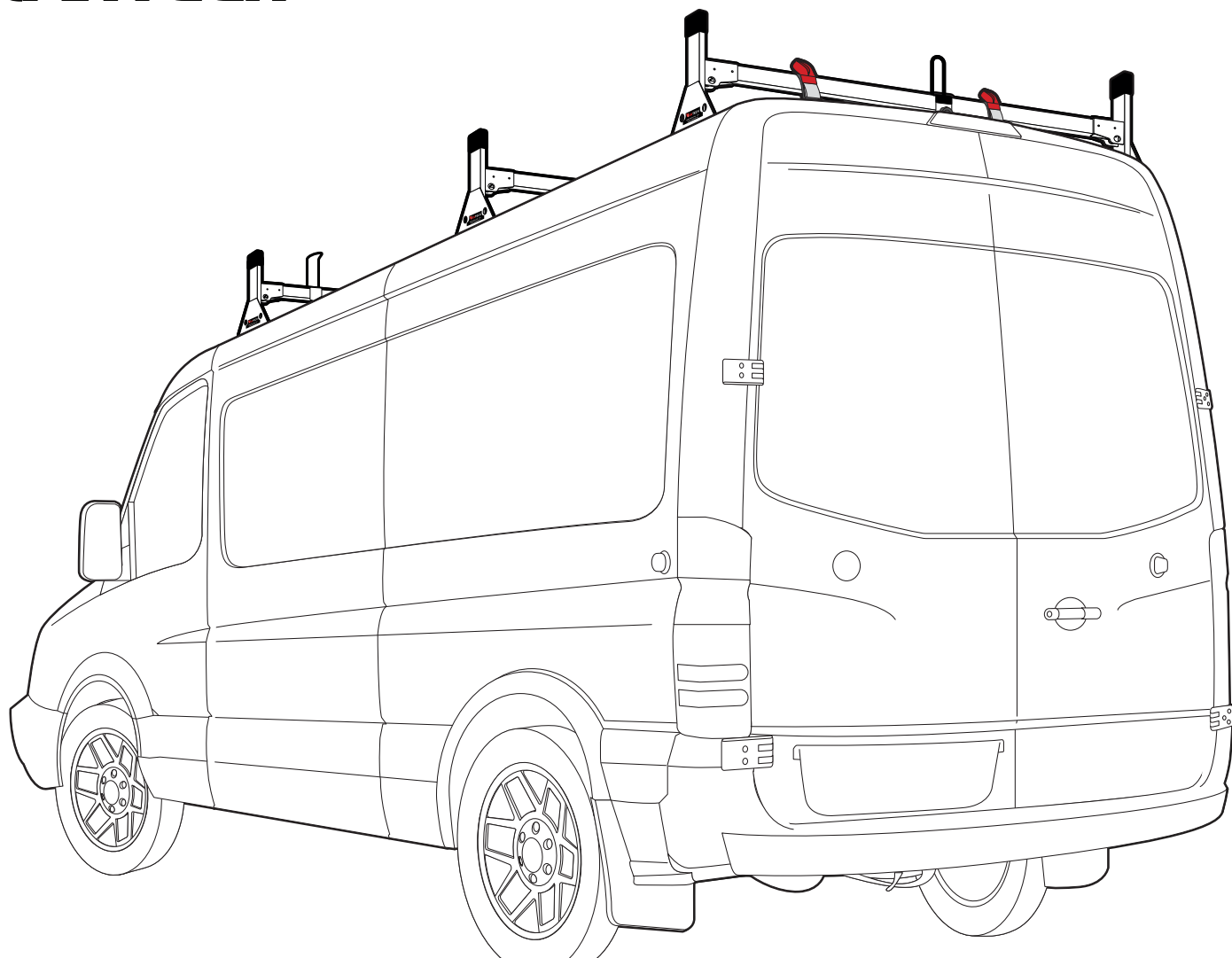



PRODUCT INFO

Part #: H2668B
System: H1 Series
Material: Steel
Fitment: Sprinter 2007-On (High Roof)
Color: Black

Fastens onto factory tracks (if available)

Tracks sold seperately
Part# R20 / R21

REQUIRED TOOLS

Power Tool With Phillips Head

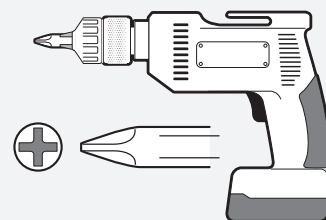

1/2" Wrench



PART#	DESCRIPTION	QTY	ITEM
S054	5/16" DOUBLE SLIDER (5" BOLT TO BOLT)	6	
B201	TAP SCREW	12	
N005	5/16" NYLON NUT	12	
W008	5/16" X 3/4" WASHER	12	
B018	5/16" X 1 3/4" CARRIAGE BOLT	4	
N016	5/16" KNOB	4	
H33	H1 MOUNTING BASE	6	
A500-50	2" X 1" X 50" CROSS BAR	3	
A02	LADDER GUIDE	2	
A06	LADDER STOPPER	2	
A69	EZ-VELCRO STRAP	2	
BG042	PLASTIC BAR GUARD 42"	3	

items not drawn to scale

EZ-Velcro Strap

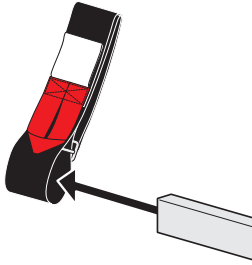

Directions

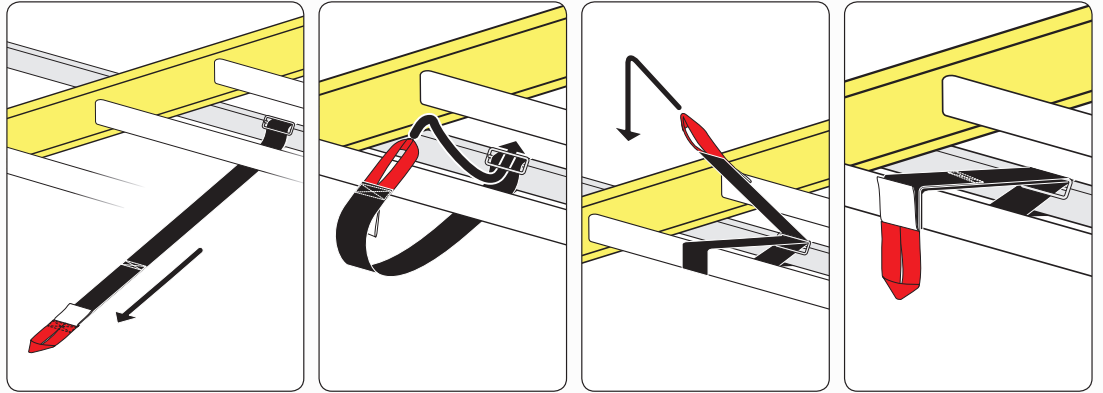

PLASTIC BAR GUARDS FOR STEEL CROSS BARS

- Remove wax paper from plastic bar guard and adhere it to the top of the Cross Bar.

- Leave 4" on each end

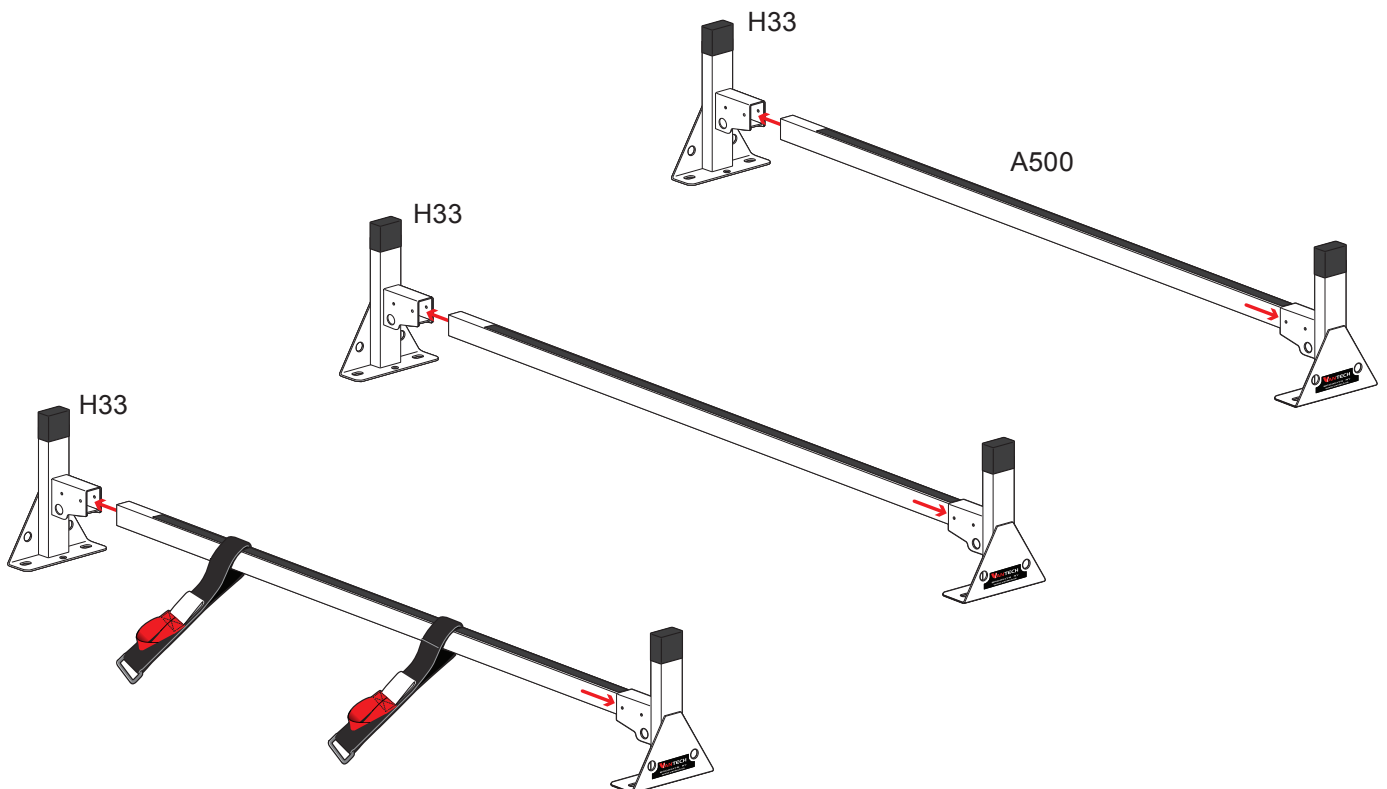
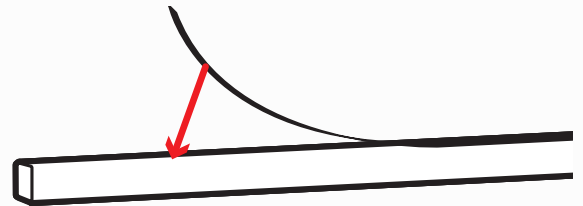
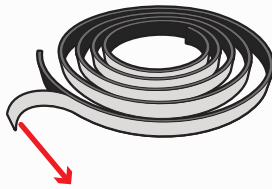

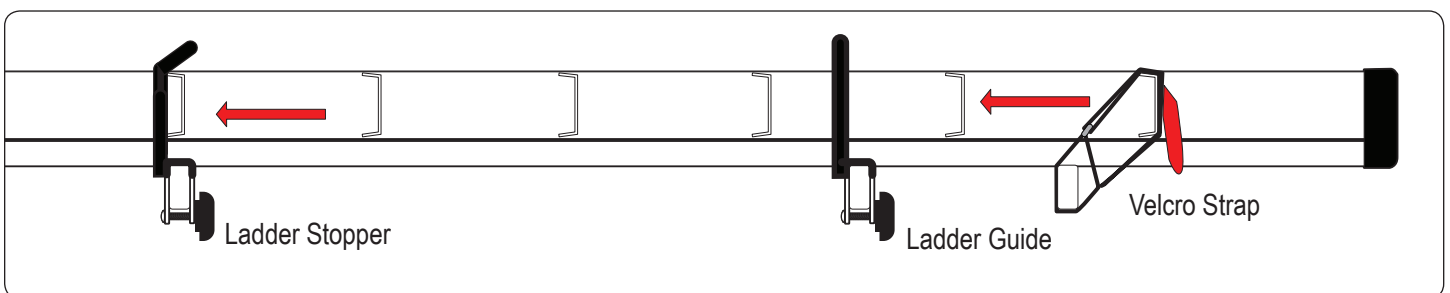
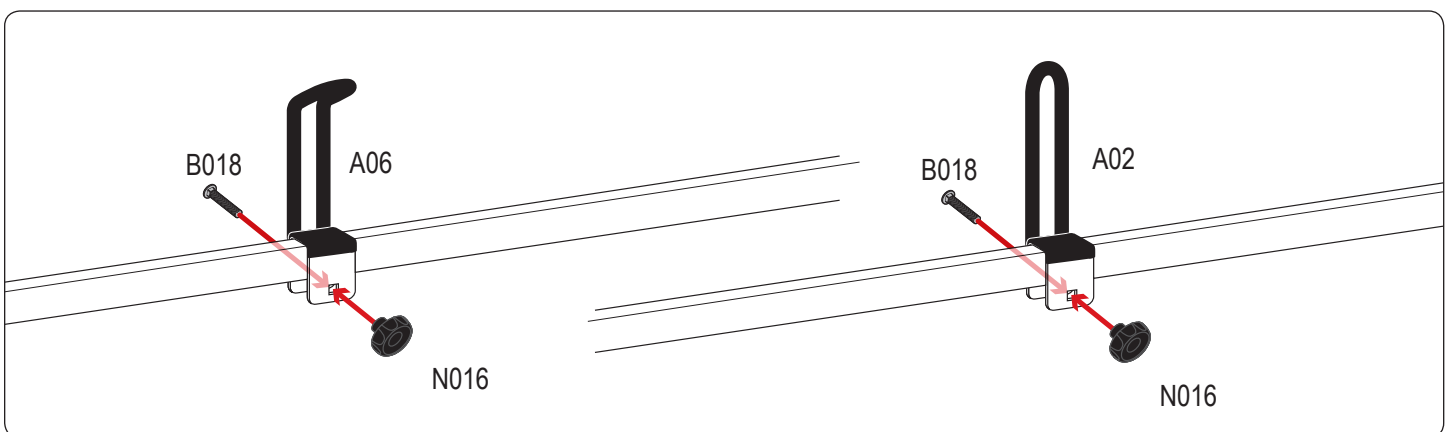
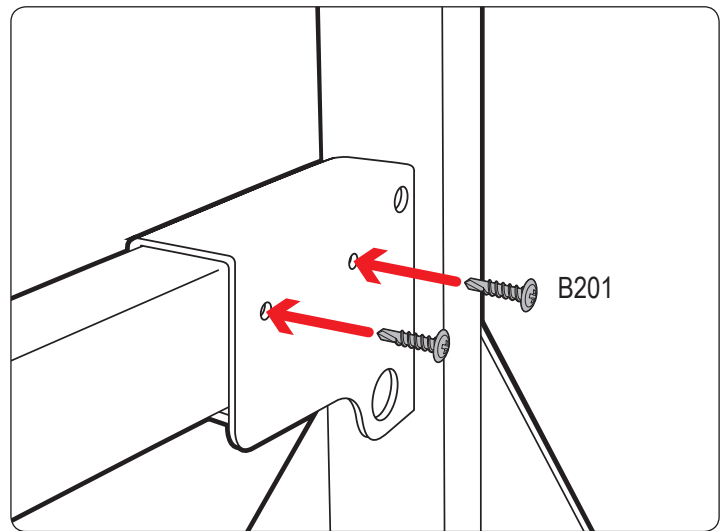
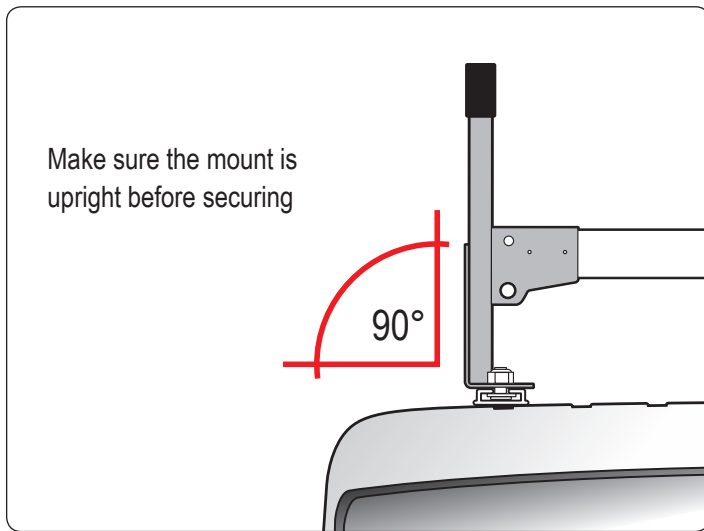
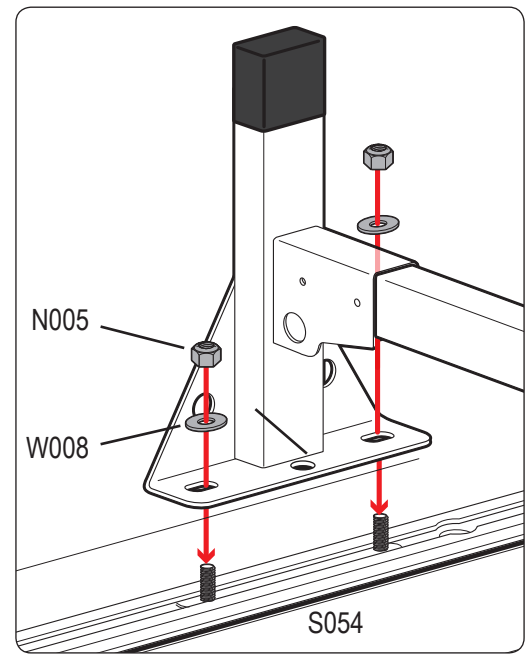
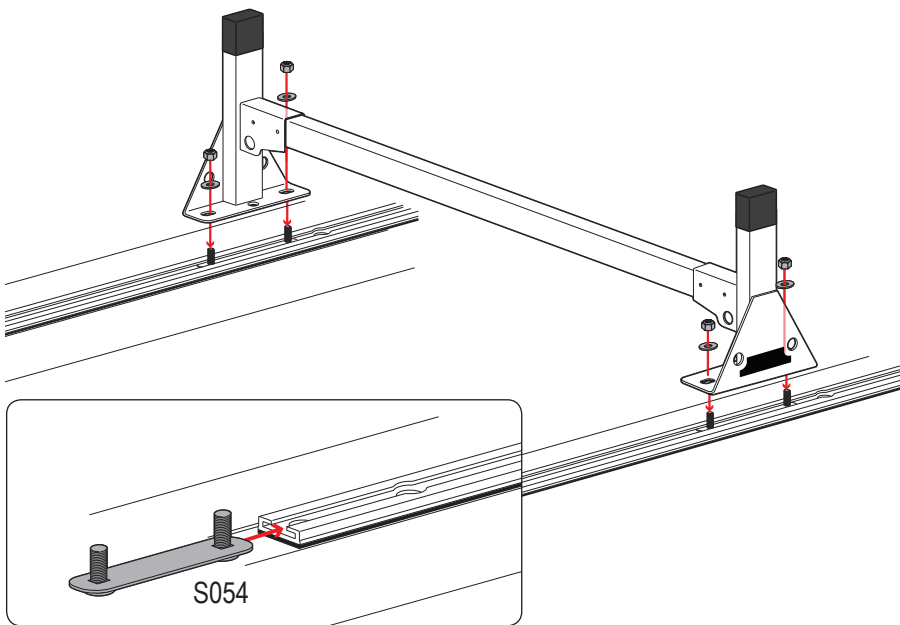

Vantech provides the best in truck and commercial van equipment.