



# Warehouse Use Only

---

Part #	QUANTITY
D020	1
D111	1
G308	4
H33B	4
A500-42B	2
BG034	2
A02	1
A06	1
A69	1

Part #:	H2095B
Dimensions:	8" X 8" X 43" (Telescopic)
Weight:	???

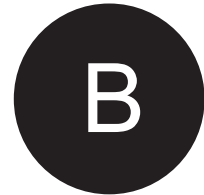

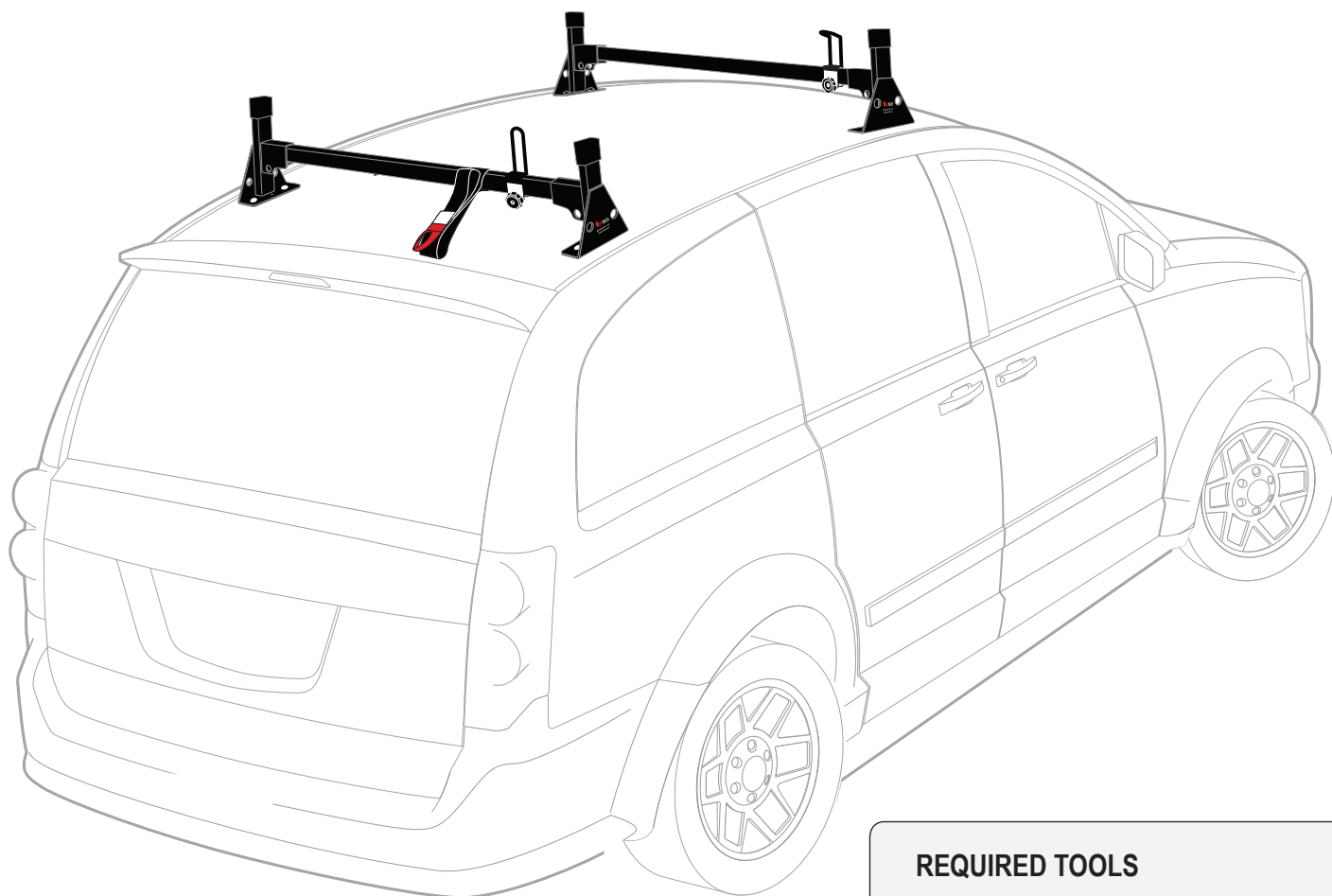

## PRODUCT INFO

Part #: H2095B  
System: H1 Series  
Material: Steel  
Fitment: Universal (Drilling Required)  
Color: Black

## REQUIRED TOOLS

Power Tool With Phillips Head

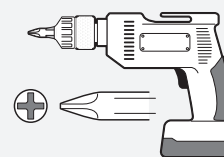

Power Tool With 5/16" Drill Bit

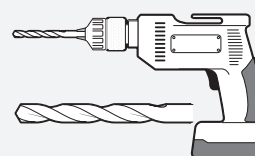







1/2" Wrench

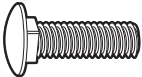
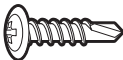

Marker

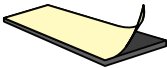

PART #	DESCRIPTION	QTY	ITEM ITEM NOT DRAWN TO SCALE
W008	5/16" X 3/4" WASHER	8	
B018	1 3/4" X 5/16" CARRIAGE BOLT	2	
B016	1 1/4" X 5/16" CARRIAGE BOLT	8	
B201	TAP SCREW	8	
N005	5/16" NYLON NUT	8	
N016	5/16" PLASTIC KNOB	2	
M03	INTERIOR PLATE	4	
H33	H1 MOUNTING BASE	4	
A500-42	2" X 1" X 42" CROSS BAR	2	
G308	POLYFOAM GASKET 2" X 8"	4	
A02	LADDER GUIDE	1	
A06	LADDER STOPPER	1	
A69	EZ-VELCRO STRAP	1	
BG034	PLASTIC BAR GUARD 34"	2	

### EZ-Velcro Strap

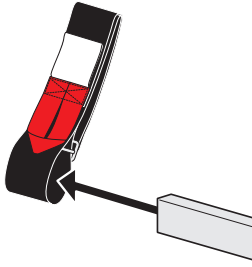

### Directions

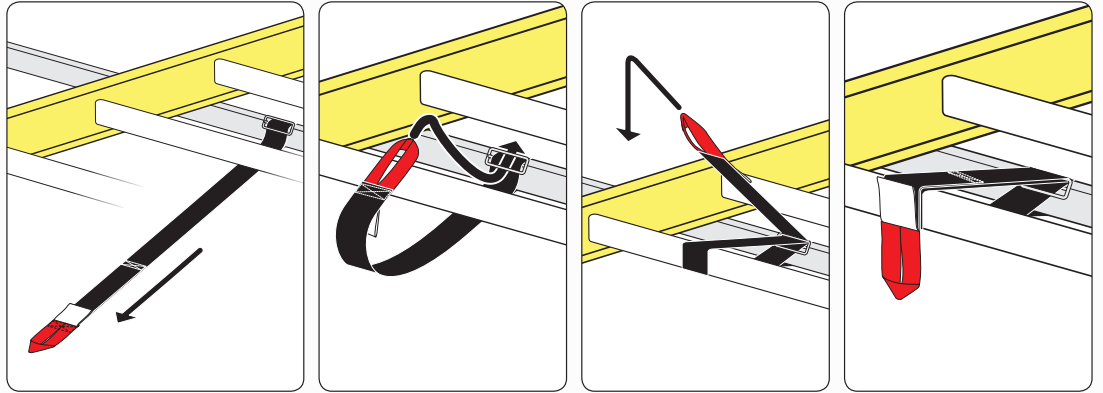

### PLASTIC BAR GUARDS FOR STEEL CROSS BARS

- Remove wax paper from plastic bar guard and adhere it to the top of the Cross Bar.

- Leave 4" on each end

