

Warehouse Use Only

Part #	QUANTITY
D062	1
D110	1
H45	6
H46	6
H34W	6
A613-57W	3
BG549	3
A02	2
A06	2
A69	2

Part #:	H1353W
Dimensions:	8" X 8" X 58" (Telescopic)
Weight:	???

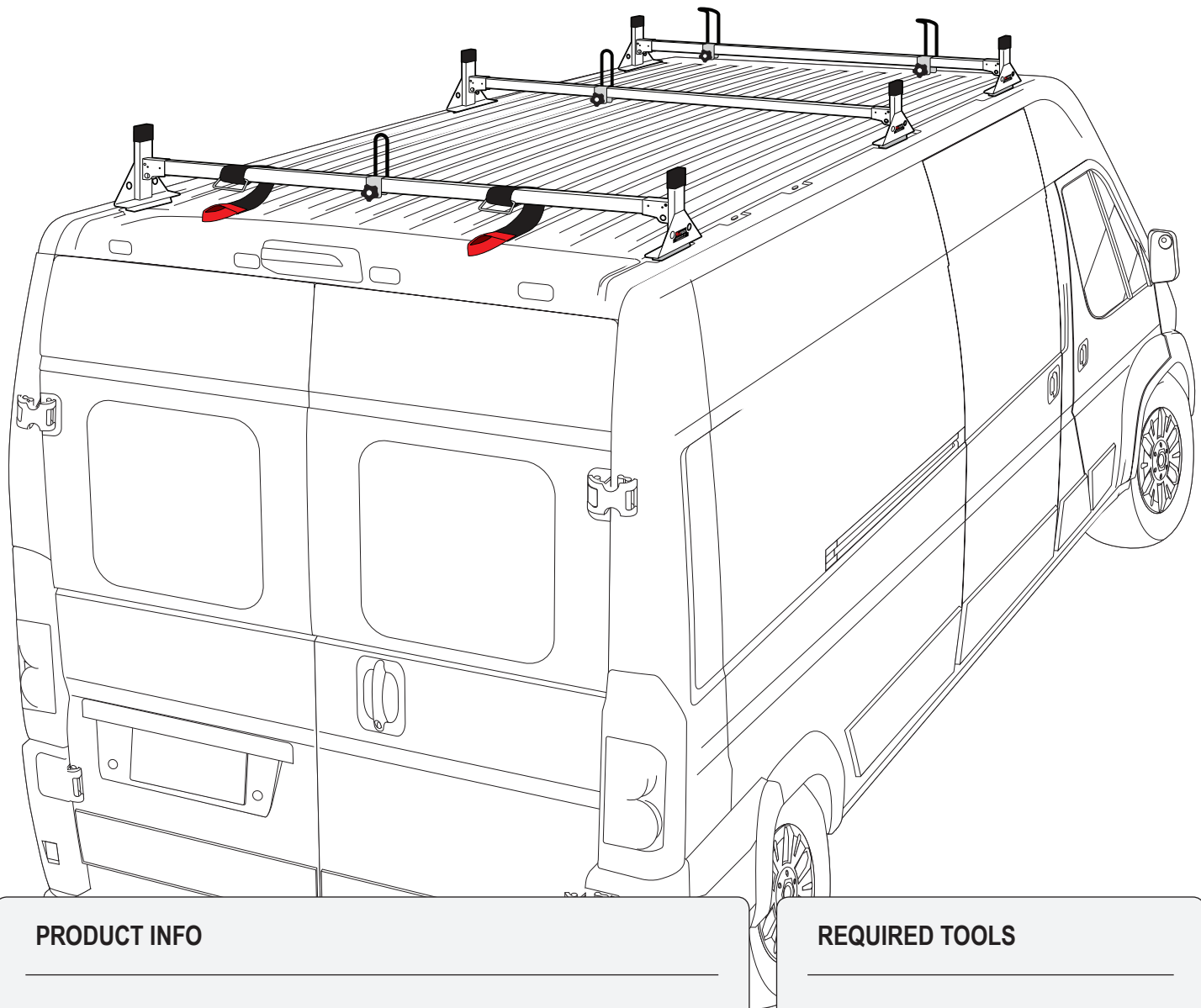



PRODUCT INFO

Part #: H1353W
System: H1 Series
Material: Aluminum
Fitment: RAM ProMaster 2013-On
Color: White





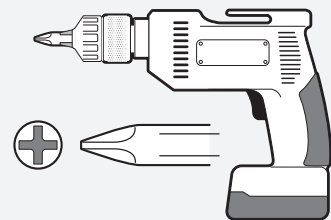





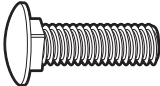

REQUIRED TOOLS

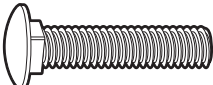
Power Tool With Phillips Head

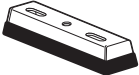
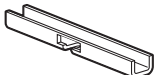

1/2" Wrench



PART#	DESCRIPTION	QTY	ITEM
B016	5/16" X 1 1/4" CARRIAGE BOLT	12	
B201	1/2" PHILLIP TAP SCREW	12	
W008	5/16" X 3/4" WASHER	12	
N005	5/16" NYLON NUT	12	
B018	5/16" X 1 3/4" CARRIAGE BOLT	4	
N016	5/16" KNOB	4	
H34	H1 MOUNTING BASE	6	
A613-57	2" X 1" X 57" CROSS BAR	3	
H45	PROMASTER MOUNT TOP	6	
H46	PROMASTER MOUNT BOTTOM	6	
A02	LADDER GUIDE	2	
A06	LADDER STOPPER	2	
A69	EZ-VELCRO STRAP	2	
BG549	RUBBER BAR GUARD 49"	3	

items not drawn to scale

EZ-Velcro Strap

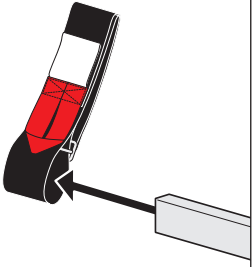

Directions

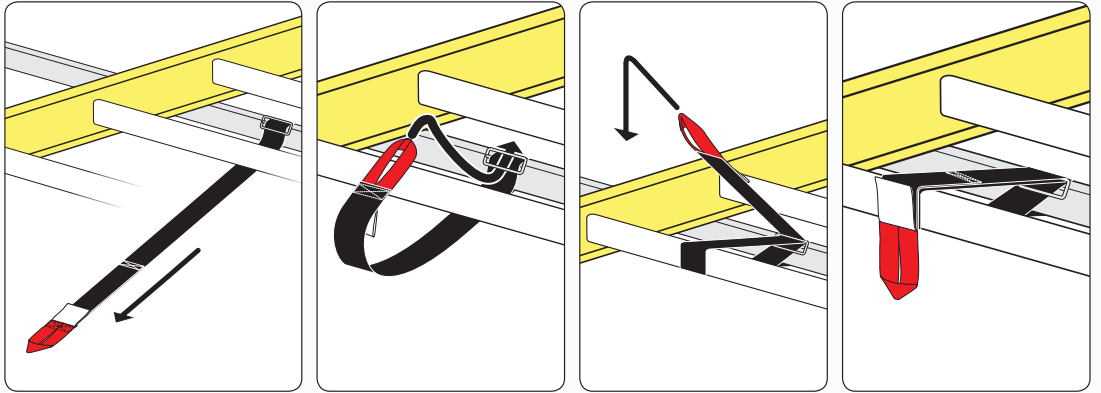

RUBBER BAR GUARDS

- Press the rubber bar guard into the channels of cross bars
- Leave 4" on each end

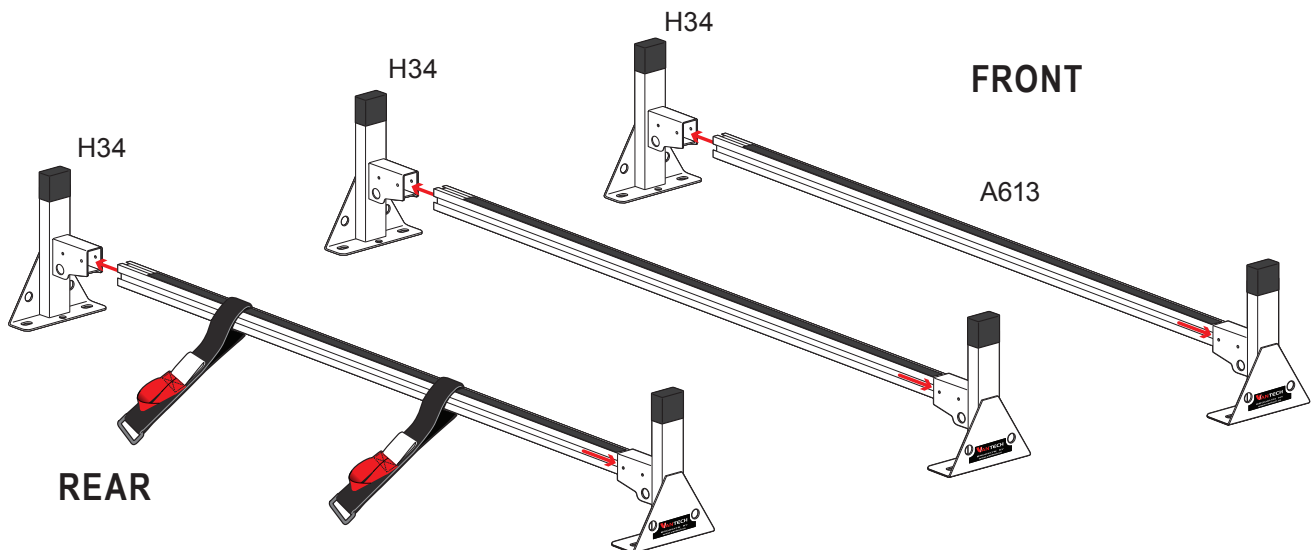
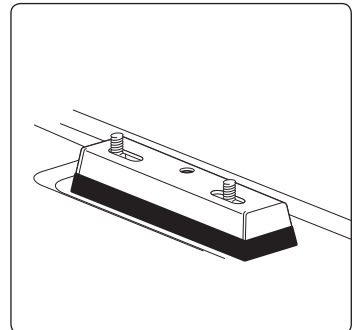
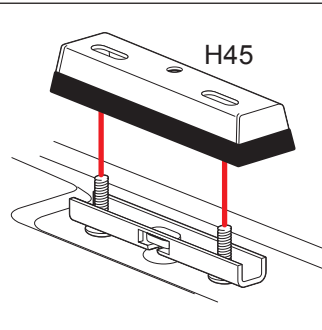
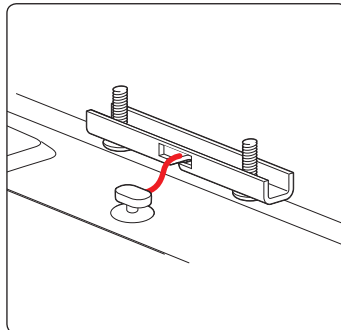
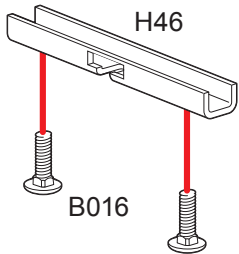

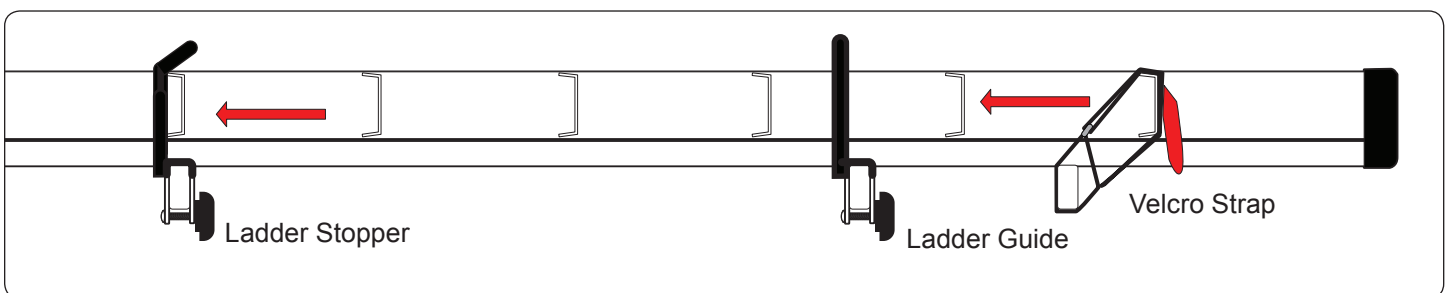
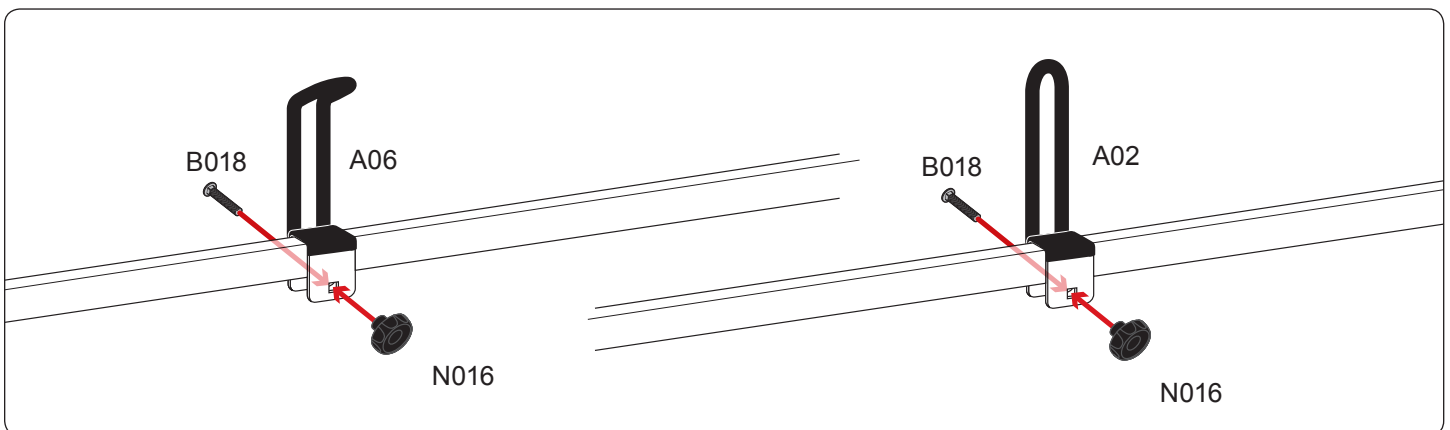
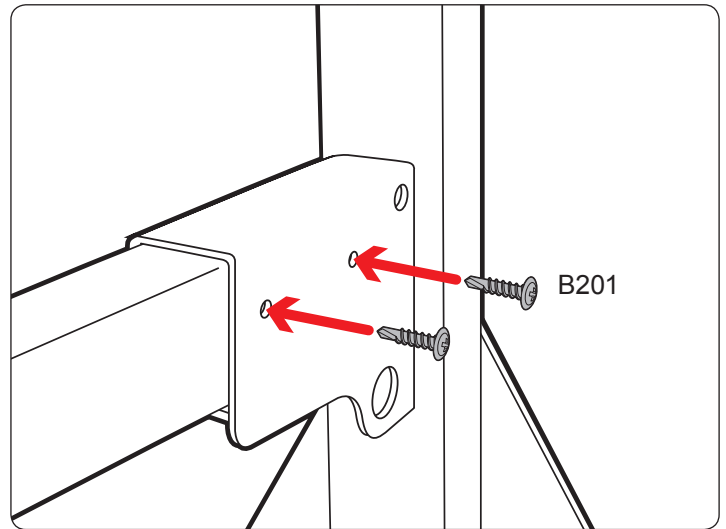
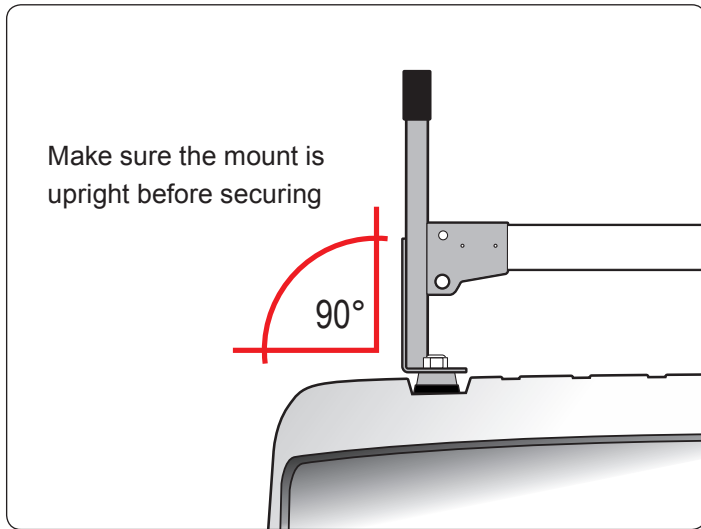
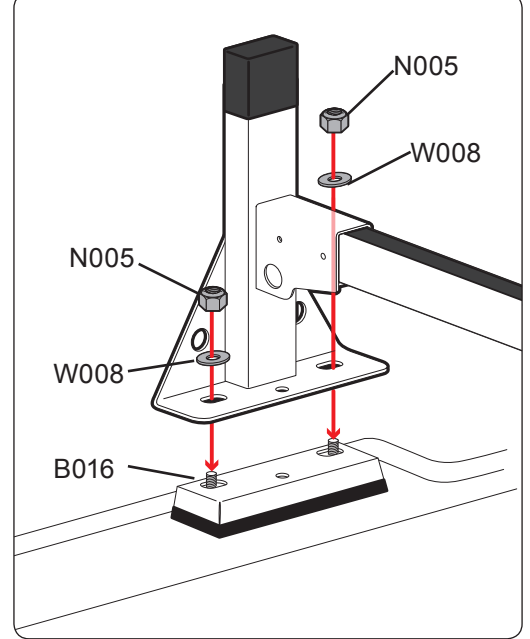
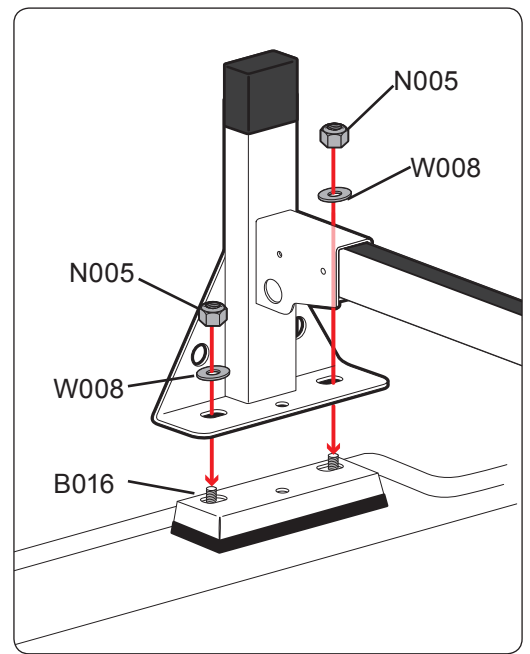
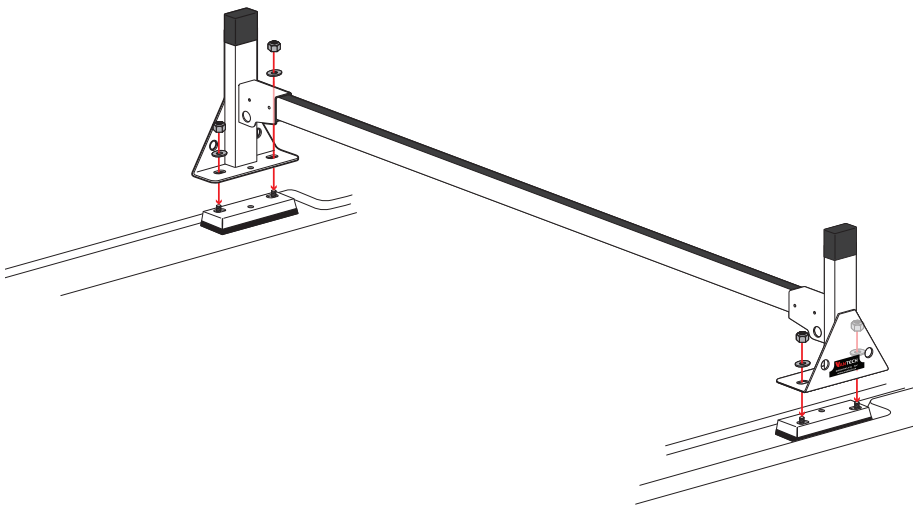

Vantech provides the best in truck and commercial van equipment.