

Warehouse Use Only

Part #	QUANTITY
D011	1
D111	1
H45	4
H46	4
H33B	4
A500-57B	2
BG049	2
A02	1
A06	1
A69	1

Part #:	H1342B
Dimensions:	8" X 8" X 58" (Telescopic)
Weight:	???

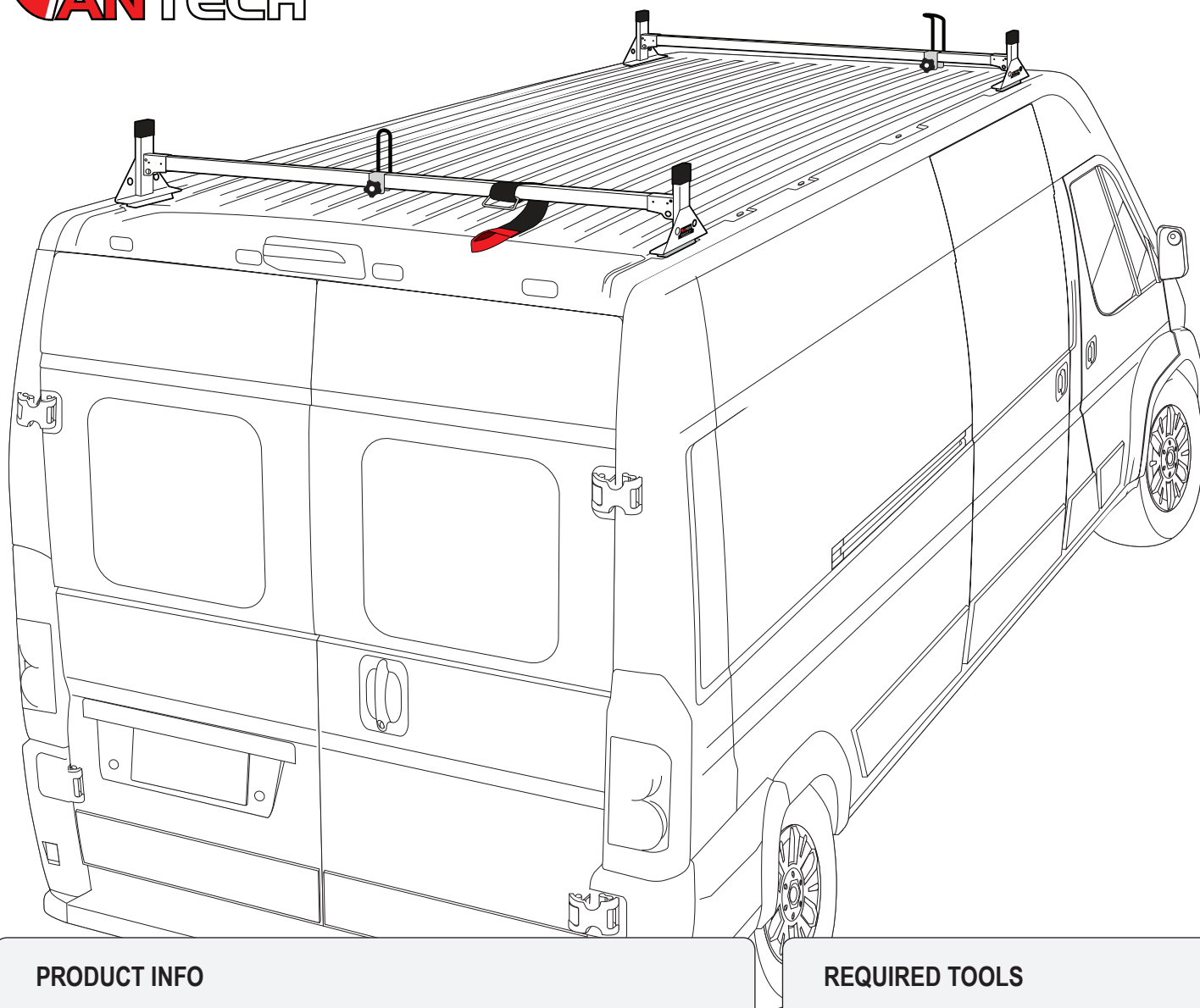



PRODUCT INFO

Part #: H1342B
System: H1 Series
Material: Steel
Fitment: RAM ProMaster 2013-On
Color: Black

REQUIRED TOOLS

Power Tool With Phillips Head

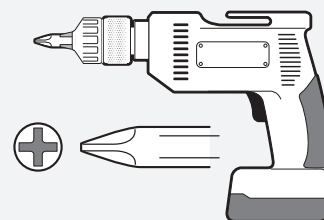

1/2" Wrench



PART#	DESCRIPTION	QTY	ITEM
B016	5/16" X 1 1/4" CARRIAGE BOLT	8	
B201	1/2" PHILLIP TAP SCREW	8	
W008	5/16" X 3/4" WASHER	8	
N005	5/16" NYLON NUT	8	
B018	5/16" X 1 3/4" CARRIAGE BOLT	2	
N016	5/16" KNOB	2	
H33	H1 MOUNTING BASE	4	
A500-57	2" X 1" X 57" CROSS BAR	2	
H45	PROMASTER MOUNT TOP	4	
H46	PROMASTER MOUNT BOTTOM	4	
A02	LADDER GUIDE	1	
A06	LADDER STOPPER	1	
A69	EZ-VELCRO STRAP	1	
BG049	PLASTIC BAR GUARD 49"	2	

items not drawn to scale

EZ-Velcro Strap

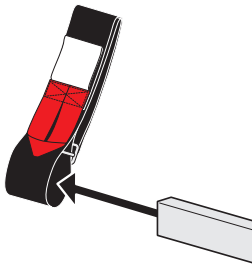

Directions

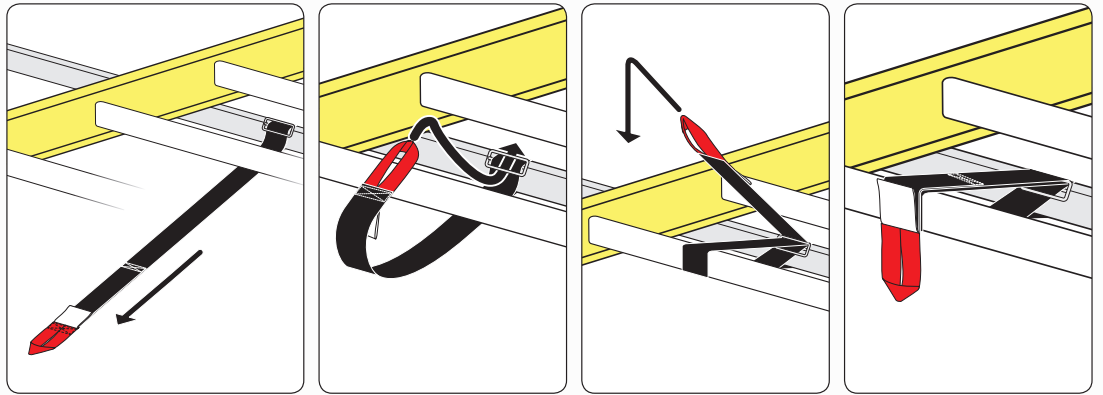

PLASTIC BAR GUARDS FOR STEEL CROSS BARS

- Remove wax paper from plastic bar guard and adhere it to the top of the Cross Bar.

- Leave 4" on each end

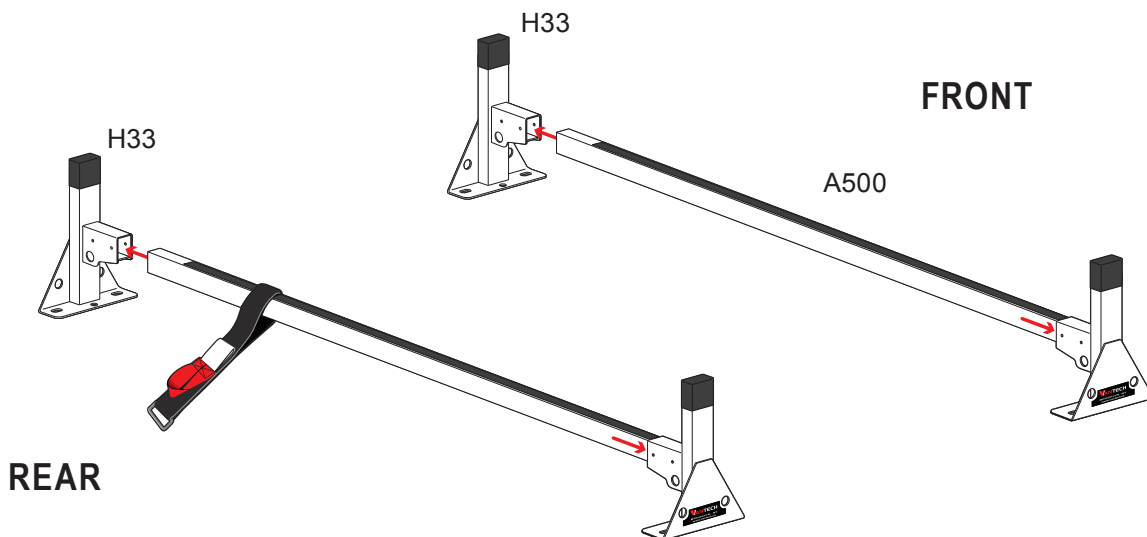
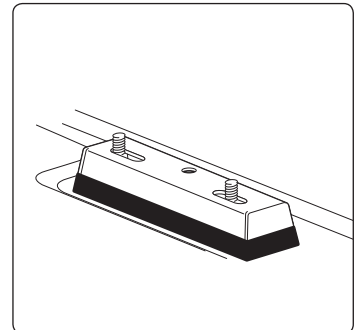
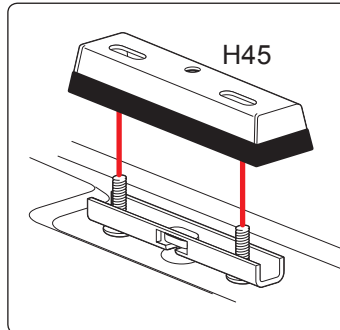
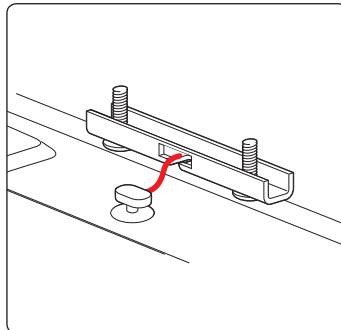
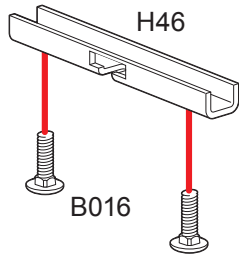
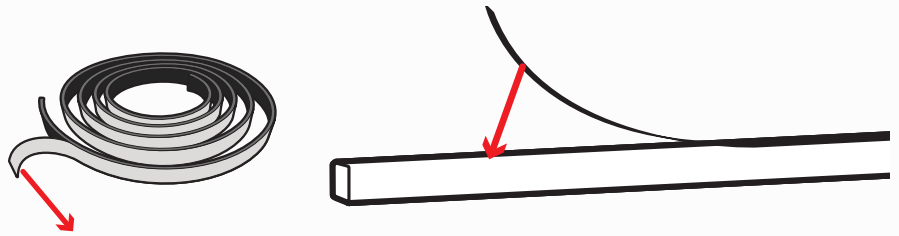

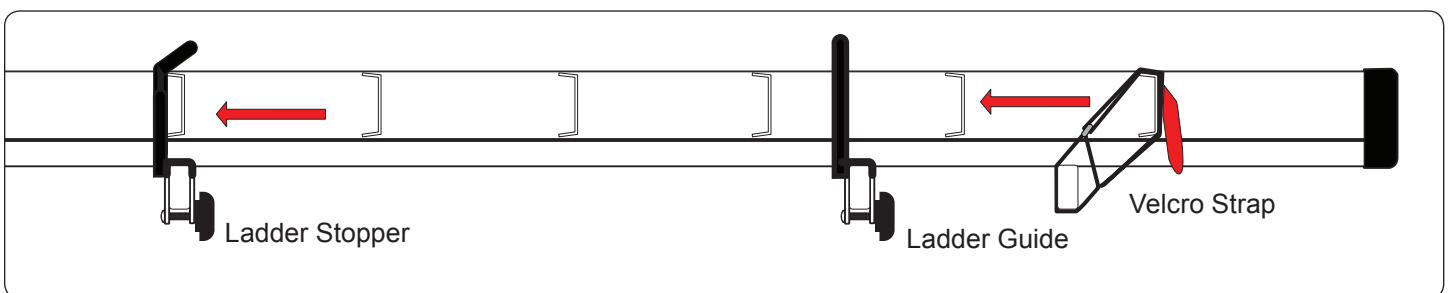
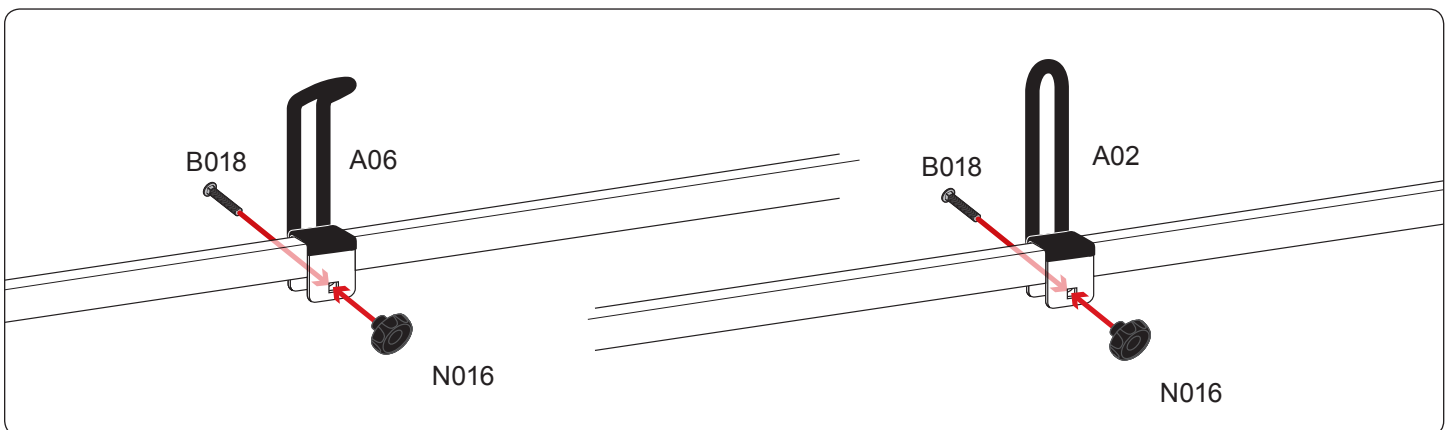
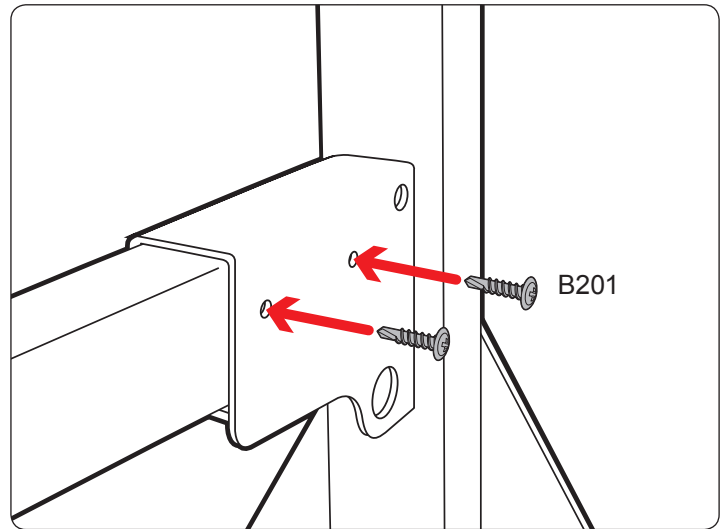
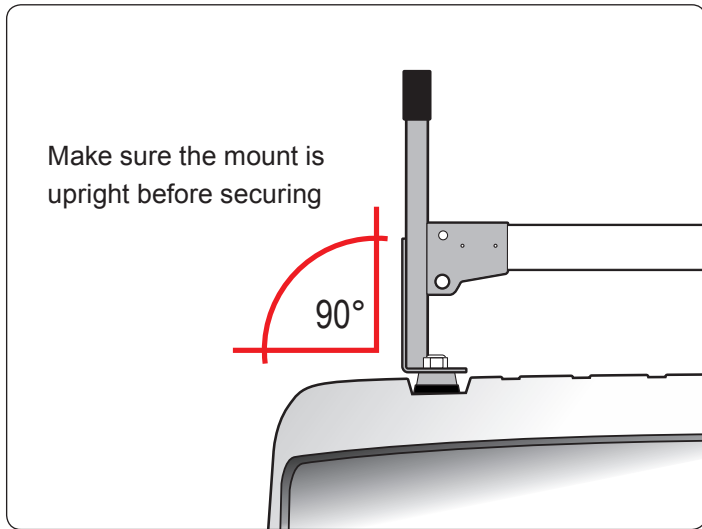
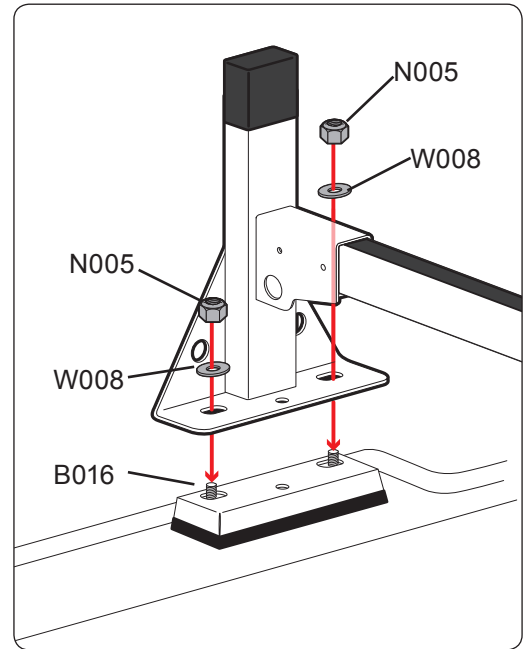
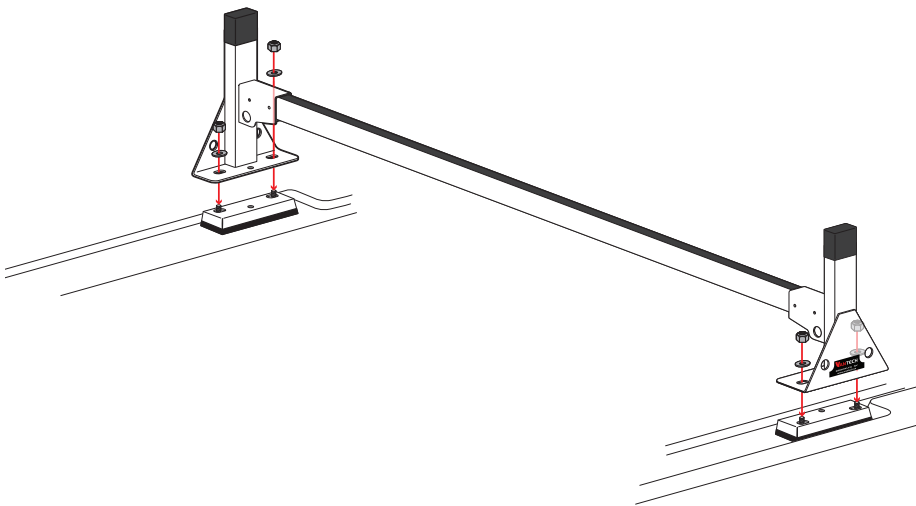

Vantech provides the best in truck and commercial van equipment.