

# Warehouse Use Only

---

Part #	QUANTITY
D008	1
D112	1
H33W	6
A500-57W	3
BG049	3
A02	2
A06	2
A69	2

Part #:	H1303W
Dimensions:	8" X 8" X 58" (Telescopic)
Weight:	???



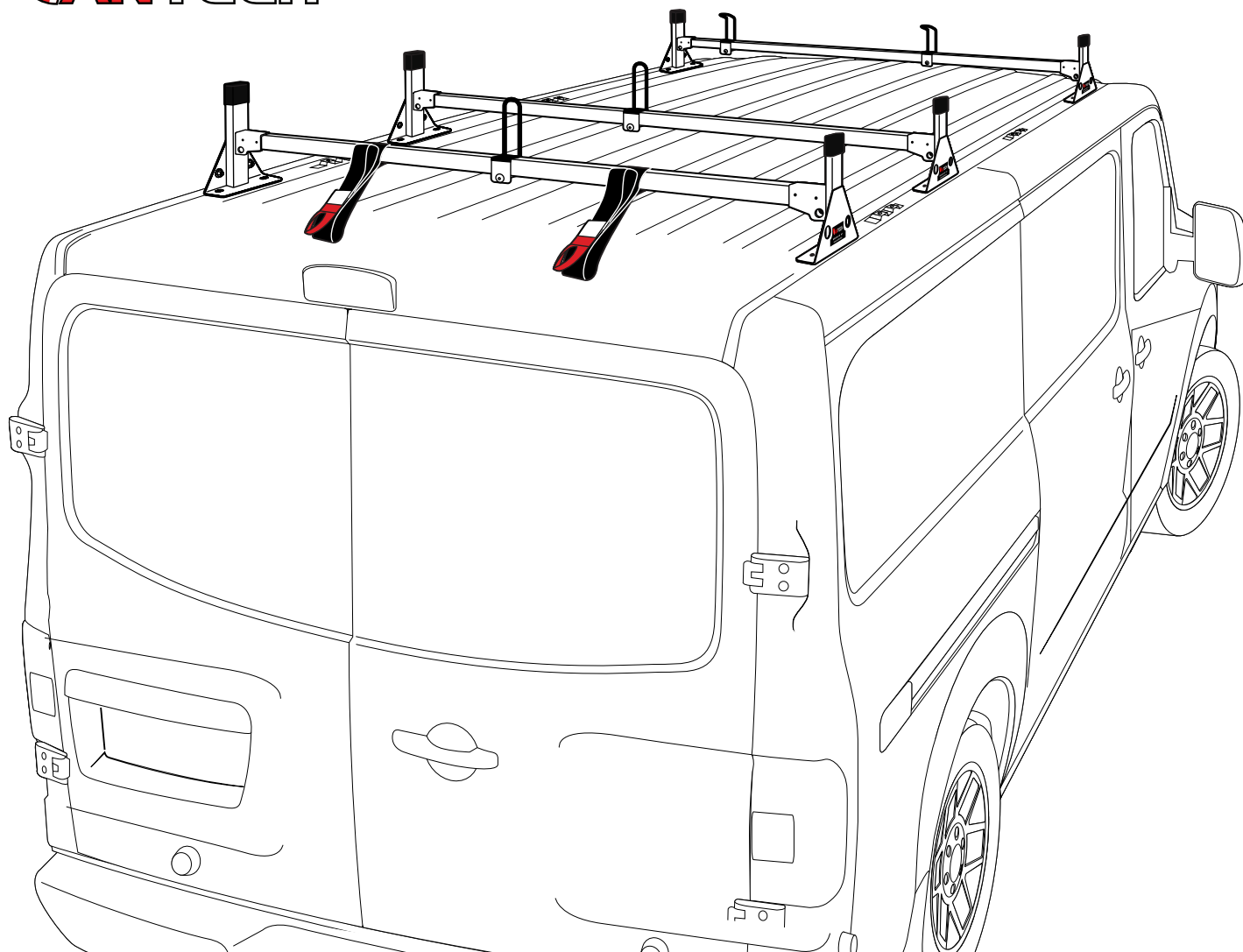

## PRODUCT INFO

Part #: H1303W  
System: H1 Series  
Material: Steel  
Fitment: Nissan NV Cargo 2012-On  
Color: White





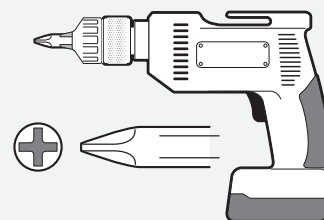



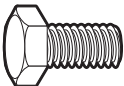

## REQUIRED TOOLS

Power Tool With Phillips Head

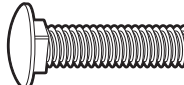

1/2" Wrench

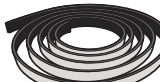

PART#	DESCRIPTION	QTY	ITEM
B064	5/16" X 3/4" HEX BOLT	12	
B201	TAP SCREW	12	
W022	5/16" LOCK WASHER	12	
W008	5/16" X 3/4" WASHER	24	
N013	5/16" CAGE NUT	12	
B018	5/16" X 1 3/4" CARRIAGE BOLT	4	
N016	5/16" KNOB	4	
H33	H1 MOUNTING BASE	6	
A500-57	2" X 1" X 57" CROSS BAR	3	
A02	LADDER GUIDE	2	
A06	LADDER STOPPER	2	
A69	EZ-VELCRO STRAP	2	
BG049	PLASTIC BAR GUARD 49"	3	

items not drawn to scale

### EZ-Velcro Strap

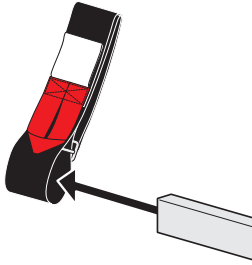

### Directions

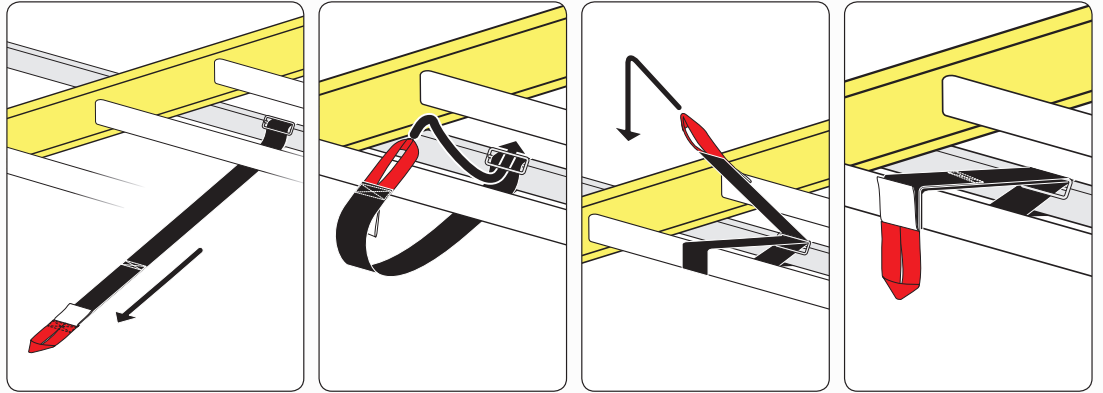

### PLASTIC BAR GUARDS FOR STEEL CROSS BARS

- Remove wax paper from plastic bar guard and adhere it to the top of the Cross Bar.

- Leave 4" on each end

